



**THE DATASHEET OF  
PE-53653NLT**



# SMT POWER INDUCTORS

## Toroid - SLIC Series



Fifteen package sizes



Current Rating: up to 23.8ADC



Frequency Range: up to 1MHz



# Pulse

A TECHNITROL COMPANY

### Electrical Specifications @ 25°C — Operating Temperature -40°C to +130°C<sup>6</sup>

Pulse Part Number <sup>4,5</sup>	Inductance @ Irated (μH)	Irated (A)	DCR (mΩ)		Inductance @ 0Adc (μH)	Reference ET (Volt-μsec)	Flux Density Factor (K1)	Core Loss Factor (K2)	Temp. Rise Factor (K3)
			TYP	MAX					
<b>LCI-20</b>									
PE-53630NL	1.01	3.40	9.35	11	1.1	0.53	5.43	3.29E-11	323.9
PE-53600NL	6.2	1.40	59.5	70	7	1.33	2.17	3.29E-11	323.9
PE-53601NL	17.6	1.00	106.25	125	22.7	2.4	1.21	3.29E-11	323.9
<b>LCI-30</b>									
PE-53650NL	3.8	4.80	14.705	17.3	5.2	1.76	1.28	1.39E-10	148.0
PE-53631NL	9.4	2.80	36.89	43.4	12.3	2.7	0.83	1.39E-10	148.0
PE-53602NL	29.7	1.40	141.1	166	35.3	4.6	0.49	1.39E-10	148.0
PE-53606NL	114	0.94	365	405	167	10	0.23	1.39E-10	148.0
<b>LCI-37</b>									
PE-53661NL	2.5	8.00	7.055	8.3	3.8	1.77	1.30	1.87E-10	114.2
PE-53651NL	5.1	5.40	15.045	17.7	7.5	2.51	0.92	1.87E-10	114.2
PE-53632NL	16.2	2.70	63	72	21.9	4.29	0.54	1.87E-10	114.2
PE-53604NL	58.1	1.30	246.5	290	73	7.83	0.29	1.87E-10	114.2
PE-53608NL	192	0.90	476	560	292	15.7	0.15	1.87E-10	114.2
PE-53611NL	383	0.72	732.7	862	672	23.5	0.10	1.87E-10	114.2
<b>LCCI-37</b>									
PE-53717NL	43.6	1.1	247.2	309	77	7.83	0.295	1.87E-10	114.23
<b>LCI-44</b>									
PE-53662NL	4.9	7.80	10.54	12.4	7.9	3.04	0.67	3.35E-10	85.7
PE-53652NL	9	5.50	25	28	14	4.06	0.51	3.35E-10	85.7
PE-53633NL	29.1	2.70	85	100	40.5	6.9	0.30	3.35E-10	85.7
PE-53613NL	645	0.74	1062.5	1250	1134	36.5	0.06	3.35E-10	85.7
<b>HCI-37</b>									
PE-53690NL	0.81	14.30	2.125	2.5	1.25	1.035	2.23	1.87E-10	114.2
PE-53680NL	1.32	11.50	3.4	4.0	2.1	1.33	1.74	1.87E-10	114.2
<b>LCCI-44</b>									
PE-53718NL	21.9	2.7	72.4	90.5	39.5	6.9	0.297	3.35E-10	85.71
<b>HCI-44</b>									
PE-53691*NL	1.68	13.90	3.06	3.6	2.8	1.83	1.12	3.35E-10	85.7
PE-53681NL	2.5	11.40	4.59	5.4	4.2	2.23	0.92	3.35E-10	85.7
<b>LCI-50</b>									
PE-53663NL	9.3	7.20	15.895	18.7	16	4.92	0.41	4.52E-10	67.9
PE-53653NL	16.1	5.10	27.2	32.0	25.9	6.27	0.32	4.52E-10	67.9
PE-53634NL	50	2.60	113.05	133	72.9	10.5	0.19	4.52E-10	67.9
PE-53614NL	1070	0.71	1445	1700	1950	54.4	0.04	4.52E-10	67.9
<b>LCCI-50</b>									
PE-53719NL	4.025	6.4	18.4	23	6.575	3.135	0.638	4.52E-10	67.89
<b>HCI-50</b>									
PE-53692*NL	3.5	12.40	5.61	6.6	6.5	3.1	0.64	4.52E-10	67.9
PE-53682NL	4.7	10.40	7.055	8.3	8.4	3.58	0.56	4.52E-10	67.9
<b>HCCI-44</b>									
PE-53361NL	0.53	23.8	1.0	3	0.88	1	2.020	3.35E-10	85.71
<b>HCCI-50</b>									
PE-53362NL	1.1	21	1.7	2.5	2.1	1.75	1.116	4.52E-10	67.89
<b>HCI-68</b>									
PE-53700*NL	5.2	15.40	5.27	6.2	10.5	5.21	0.35	9.58E-10	44.6
PE-53683NL	9.4	10.90	10.455	12.3	17.6	6.84	0.27	9.58E-10	44.6
<b>HCCI-68</b>									
PE-53363NL	2.1	22.4	2.5	3.4	4	3.25	0.559	9.58E-10	44.56

**NOTES:**

- Reference values are for an inductor with a 55°C temperature rise. The core loss is 10% of the copper loss at the ET listed and 500kHz.
- Core does not saturate abruptly. The ET and DC current are limited by the desired inductance and temperature rise.
- In high volt-time applications, additional heating in the component can occur due to core losses in the inductor which may necessitate derating the current in order to limit the temperature rise of the component. In order to determine the approximate total losses (or temperature rise) for a given application, both copper and core losses should be taken into account.

**Estimated Temperature Rise:**

$$\begin{aligned} \text{Trise} &= K3 * (\text{Coreloss(W)} + \text{Copperloss(W)})^{0.33} \text{ (C)} \\ \text{CopperLoss} &= \text{Irms}^2 * \text{DCR\_Typical (m}\Omega) / 1000 \\ \text{CoreLoss} &= K2 * (\text{Freq\_kHz})^{1.26} * (\Delta B)^{2.11} \\ \Delta B &= K1 * \text{Volt-}\mu\text{sec} * 100 \end{aligned}$$

- Optional Tape & Reel packaging can be ordered by adding a "T" suffix to the part number (i.e. PE-53600NL becomes PE-53600NLT). Pulse complies to industry standard tape and reel specification EIA481.
- The "NL" suffix indicates an RoHS-compliant part number. Non-NL suffixed parts are not necessarily RoHS compliant, but are electrically and mechanically equivalent to NL versions. If a part number does not have the "NL" suffix, but an RoHS compliant version is required, please contact Pulse for availability.
- The temperature of the component (ambient plus temperature rise) must be within the stated operating temperature range.

### Mechanicals

#### High Current Inductors (HCI)

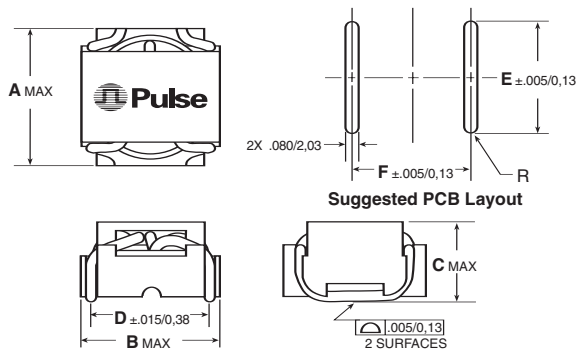

#### Low Current Inductors (LCI)

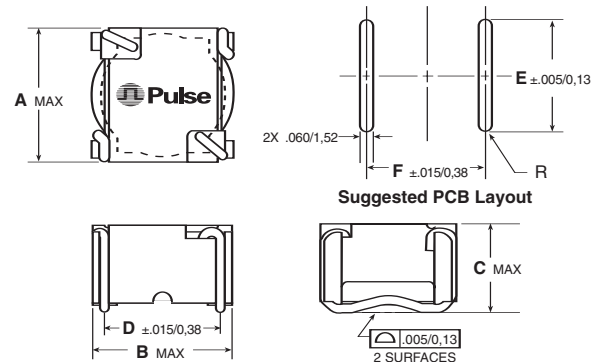

\* Dimension "C" is .400/10,16 for the marked models because of heavier wire gage.

PKG	A	B	C	D	E	F
HCI-37	.620	.605	.370	.500	.440	.500
	15,75	15,37	9,40	12,70	11,18	12,70
HCI-44	.670	.670	.390*	.560	.490	.570
	17,02	17,02	9,91	14,22	12,45	14,48
HCI-50	.740	.740	.390*	.630	.560	.640
	18,80	18,80	9,91	16,00	14,22	16,26
HCI-68	.940	.940	.390*	.820	.700	.830
	23,88	23,88	9,91	20,83	17,78	21,08

Dimensions:  $\frac{\text{Inches}}{\text{mm}}$

PKG	A	B	C	D	E	F
LCI-20	.340	.340	.270	.260	.300	.270
	8,64	8,64	6,86	6,60	7,62	6,86
LCI-30	.435	.440	.360	.350	.400	.360
	11,05	11,18	9,14	8,89	10,16	9,14
LCI-37	.565	.570	.360	.450	.520	.460
	14,35	14,48	9,14	11,43	13,21	11,68
LCI-44	.600	.620	.390	.500	.550	.500
	15,24	15,75	9,91	12,70	13,97	12,70
LCI-50	.670	.700	.390	.580	.620	.590
	17,02	17,78	9,91	14,73	15,75	14,99

#### High Current Coupled Inductors (HCCI)

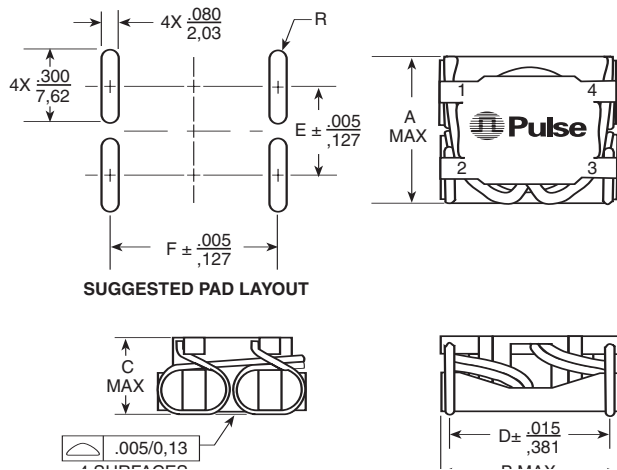

#### Low Current Coupled Inductors (LCCI)

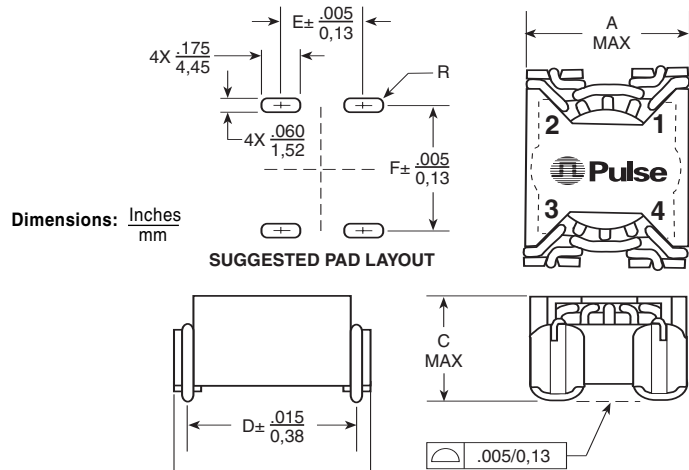

#### Schematic

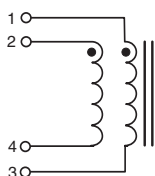

#### Size Codes

	HCCI-44	HCCI-50	HCCI-68	LCCI-37	LCCI-44	LCCI-50
A	.715/18,16	.800/20,32	1.000/25,40	.560/14,22	.590/14,99	.670/17,02
B	.865/21,97	.910/23,11	1.110/28,19	.645/16,38	.715/18,16	.770/19,56
C	.390/9,91	.390/9,91	.390/9,91	.350/8,89	.390/9,91	.390/9,91
D	.760/10,30	.800/20,32	1.000/25,40	.520/13,21	.600/15,24	.650/16,51
E	.360/9,14	.440/11,18	.620/15,75	.340/8,64	.370/9,40	.445/11,30
F	.770/19,56	.810/20,57	1.010/25,65	.530/13,46	.610/15,49	.660/16,76

#### Schematic

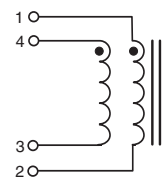

Dimensions:  $\frac{\text{Inches}}{\text{mm}}$

## Looking for pricing, stock, or lifecycle information?

Click below to explore more details on WIN SOURCE:

 [View PE-53653NLT on WIN SOURCE](#)

 [Pulse Information](#)

## Optimize Your Supply Chain with WIN SOURCE Solutions

-  Global Sourcing Solution
-  Obsolete Management
-  Cost Control Management
-  Shortage Management
-  Alternative Solution
-  Excess Inventory Management