



**THE DATASHEET OF
SK14-13**



Features

- For Surface Mounted Applications
- High Temperature Metallurgically Bonded Contacts
- Capable of Meeting Environmental Standards of MIL-STD-19500
- High Reliability
- Submersible Temperature of 265°C for 10 Seconds in Solder Bath
- Available in Lead Free Finish/RoHS Compliant Version (Note 3)

Mechanical Data

- Case: SMB
- Case Material: Molded Plastic. UL Flammability Classification Rating 94V-0
- Moisture Sensitivity: Level 1 per J-STD-020C
- Also Available in Lead Free Plating (Matte Tin Finish). Please see Ordering Information, Note 5, on Page 3
- Terminals: Solderable per MIL-STD-202, Method 208
- Polarity: Cathode Band or Notch
- Approx. Weight: 0.093 grams

NOT RECOMMENDED FOR NEW DESIGNS -
Use B1x0B Series

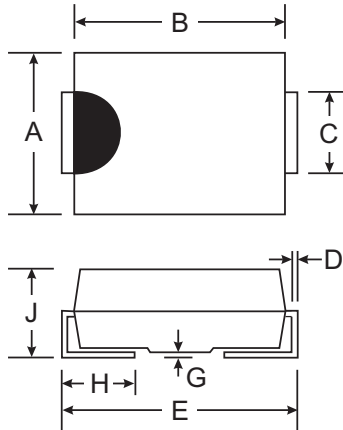

SMB		
Dim	Min	Max
A	3.30	3.94
B	4.00	4.65
C	1.95	2.21
D	0.15	0.40
E	5.00	6.00
G	0.10	0.20
H	0.76	1.52
J	2.00	2.62
All Dimensions in mm		

Maximum Ratings and Electrical Characteristics

Ratings at 25°C ambient temperature unless otherwise specified.
Single phase, halfwave, 60Hz resistive or inductive load.

Characteristic	Symbol	SK12	SK13	SK14	SK15	SK16	Units
Maximum Recurrent Peak Reverse Voltage	V_{RRM}	20	30	40	50	60	V
Maximum RMS Voltage	V_{RMS}	14	21	28	35	42	V
Maximum DC Blocking Voltage	V_{DC}	20	30	40	50	60	V
Maximum Average Forward Rectified Current @ $T_A = 75^\circ\text{C}$	$I_{(AV)}$	1.0					A
Peak Forward Surge Current 8.3 ms single half sine-wave superimposed on rated load (JEDEC Method)	I_{FSM}	25					A
Maximum Instantaneous Forward Voltage at 1.0A	V_F	0.55			0.70		V
Maximum DC Reverse Current at Rated DC Blocking Voltage @ $T_A = 25^\circ\text{C}$ @ $T_A = 100^\circ\text{C}$	I_R				0.5 10		mA
Maximum Full Load Reverse Current Full Cycle Average @ $T_A = 75^\circ\text{C}$	I_R	5					mA
Maximum Thermal Resistance (See Note 1)	$R_{\theta JL}$	25					°C/W
Typical Total Capacitance (See Note 2)	C_T	110					pF
Operating Temperature Range	T_J	-65 to +125					°C
Storage Temperature Range	T_{STG}	-65 to +150					°C

- Notes:
1. Thermal resistance from junction to lead.
 2. Measured at 1.0MHz and applied reverse voltage of 4.0V.
 3. RoHS revision 13.2.2003. Glass and High Temperature Solder Exemptions Applied, see EU Directive Annex Notes 5 and 7.

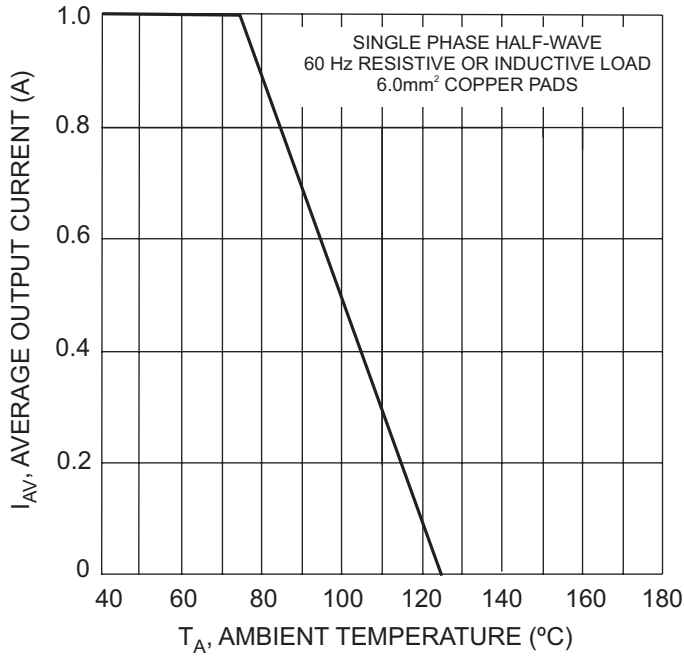

Fig. 1, Forward Current Derating Curve

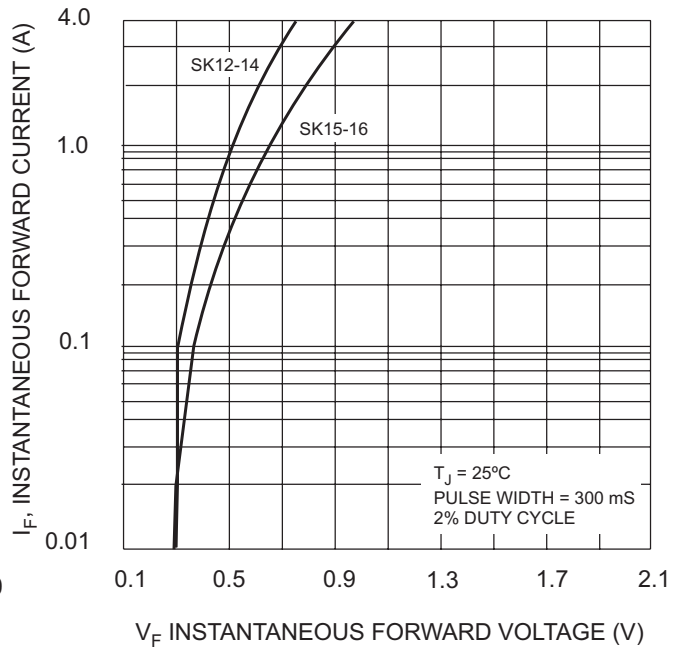

Fig. 2, Typical Forward Characteristics

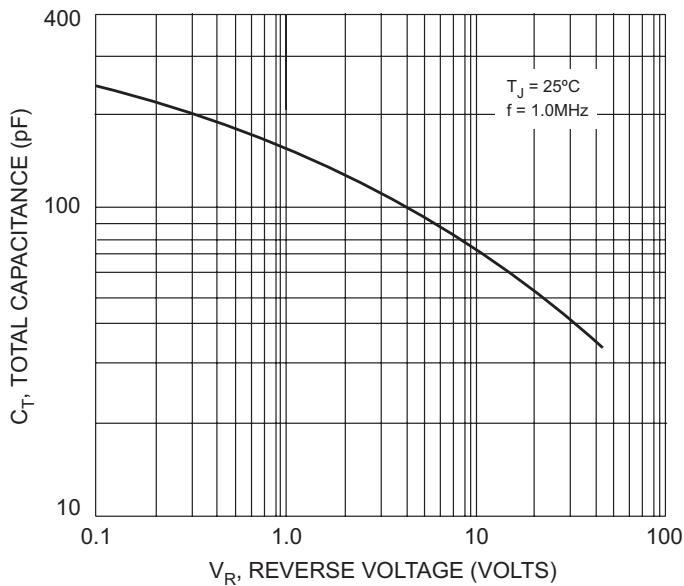

Fig. 3, Typical Total Capacitance

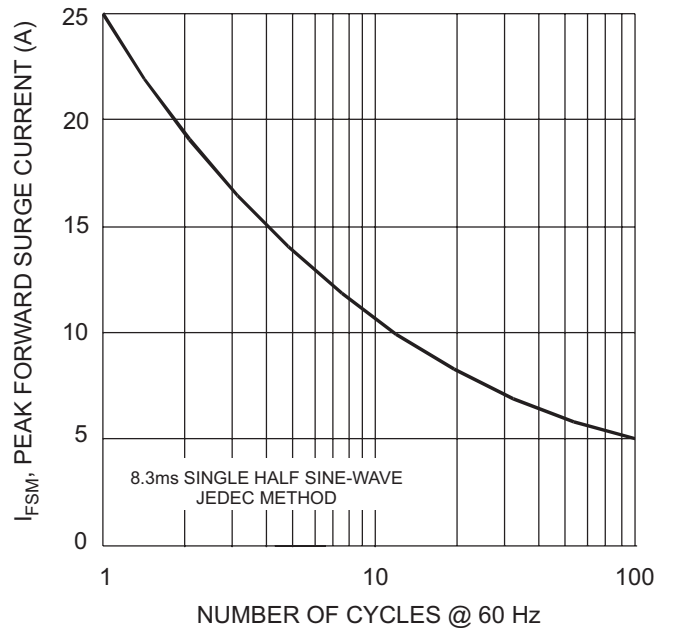

Fig. 4, Max Non-Repetitive Peak Forward Surge Current

**NOT RECOMMENDED FOR NEW DESIGNS -
Use B1x0B Series**

Ordering Information (Note 4)



Device	Packaging	Shipping
SK12-13	SMB	3000/Tape & Reel
SK13-13	SMB	3000/Tape & Reel
SK14-13	SMB	3000/Tape & Reel
SK15-13	SMB	3000/Tape & Reel
SK16-13	SMB	3000/Tape & Reel

- Notes:
4. For Packaging Details, go to our website at <http://www.diodes.com/datasheets/ap02007.pdf>.
 5. For Lead Free Finish; RoHS Compliant version part numbers, please add "-F" suffix to the part numbers above. Example: SK14-13-F.

**NOT RECOMMENDED FOR NEW DESIGNS -
Use B1x0B Series**

Looking for pricing, stock, or lifecycle information?

Click below to explore more details on WIN SOURCE:

-  [View SK14-13 on WIN SOURCE](#)
-  [Diodes Incorporated Information](#)

Optimize Your Supply Chain with WIN SOURCE Solutions

-  Global Sourcing Solution
-  Obsolete Management
-  Cost Control Management
-  Shortage Management
-  Alternative Solution
-  Excess Inventory Management