



# THE DATASHEET OF OPA512BM





OPA512

# Very-High Current—High Power OPERATIONAL AMPLIFIER

## FEATURES

- WIDE SUPPLY RANGE:  $\pm 10V$  to  $\pm 50V$
- HIGH OUTPUT CURRENT: 15A Peak
- CLASS A/B OUTPUT STAGE: Low Distortion
- VOLTAGE-CURRENT LIMIT PROTECTION CIRCUIT
- SMALL TO-3 PACKAGE

## APPLICATIONS

- SERVO AMPLIFIER
- MOTOR DRIVER
- SYNCRO EXCITATION
- AUDIO AMPLIFIER
- TEST PIN DRIVER

## DESCRIPTION

The OPA512 is a high voltage, very-high current operational amplifier designed to drive a wide variety of resistive and reactive loads. Its complementary class A/B output stage provides superior performance in applications requiring freedom from cross-over distortion. User-set current limit circuitry provides protection to the amplifier and load in fault conditions. A resistor-programmable voltage-current limiter circuit may be used to further protect the amplifier from damaging conditions.

The OPA512 employs a laser-trimmed monolithic integrated circuit to bias the output transistors, providing excellent low-level signal fidelity and high output voltage swing. The reduced internal parts count made possible with this monolithic IC improves performance and reliability.

This hybrid integrated circuit is housed in a hermetic TO-3 package and all circuitry is electrically-isolated from the case. This allows direct mounting to a chassis or heat sink without cumbersome insulating hardware and provides optimum heat transfer.

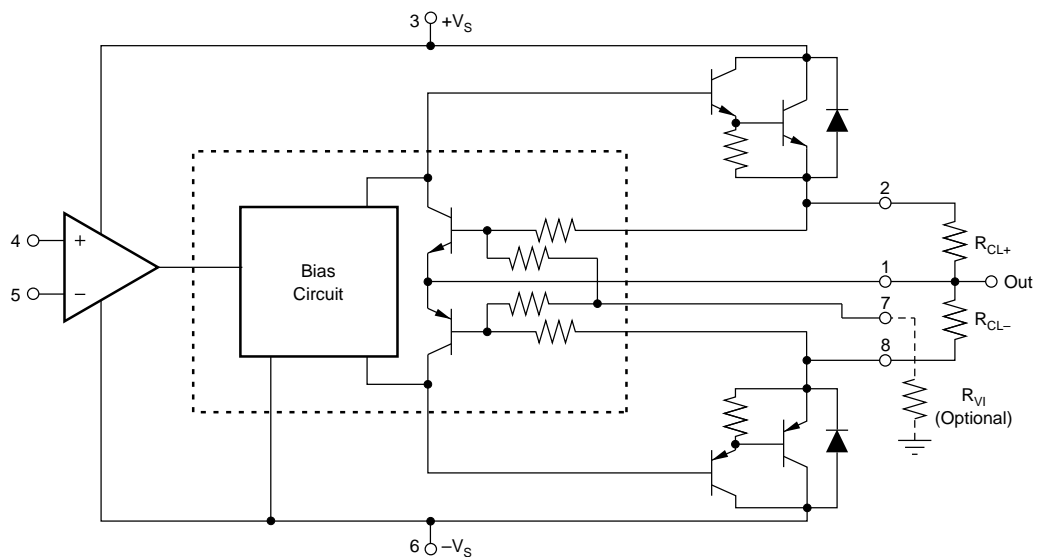

International Airport Industrial Park • Mailing Address: PO Box 11400 • Tucson, AZ 85734 • Street Address: 6730 S. Tucson Blvd. • Tucson, AZ 85706  
 Tel: (520) 746-1111 • Twx: 910-952-1111 • Cable: BBRCORP • Telex: 066-6491 • FAX: (520) 889-1510 • Immediate Product Info: (800) 548-6132

# SPECIFICATIONS

## ELECTRICAL

At  $T_C = +25^\circ\text{C}$ , and  $V_S = \pm 40\text{V}$ , unless otherwise noted.

PARAMETER	CONDITIONS	OPA512BM			OPA512SM			UNITS
		MIN	TYP	MAX	MIN	TYP	MAX	
<b>INPUT OFFSET VOLTAGE</b>								
Initial Offset	Specified Temp. Range		$\pm 2$	$\pm 6$		$\pm 1$	$\pm 3$	mV
vs Temperature			$\pm 10$	$\pm 65$		*	$\pm 40$	$\mu\text{V}/^\circ\text{C}$
vs Supply Voltage			$\pm 30$	$\pm 200$		*	*	$\mu\text{V}/\text{V}$
vs Power			$\pm 20$			*		$\mu\text{V}/\text{V}$
<b>INPUT BIAS CURRENT</b>								
Initial	Specified Temp. Range		12	30		10	20	nA
vs Temperature			$\pm 50$	400		*	*	$\text{pA}/^\circ\text{C}$
vs Supply Voltage			$\pm 10$			*		$\text{pA}/\text{V}$
<b>INPUT OFFSET CURRENT</b>								
Initial	Specified Temp. Range		$\pm 12$	$\pm 30$		$\pm 5$	$\pm 10$	nA
vs Temperature				$\pm 50$		*		$\text{pA}/^\circ\text{C}$
<b>INPUT IMPEDANCE, DC</b>			200			*		M $\Omega$
<b>INPUT CAPACITANCE</b>			3			*		pF
<b>VOLTAGE RANGE</b>								
Common-Mode Voltage	Specified Temp. Range	$\pm( V_S  - 5)$	$\pm( V_S  - 3)$		*	*		V
Common-Mode Rejection	Specified Temp. Range	74	100		*	*		dB
<b>GAIN</b>								
Open-Loop Gain at 10Hz	1k $\Omega$ Load Specified Temp. Range		110			*		dB
Gain-Bandwidth Product, 1MHz	8 $\Omega$ Load	96	108		*	*		dB
	8 $\Omega$ Load		4		*	*		MHz
Power Bandwidth	8 $\Omega$ Load	13	20		*	*		kHz
Phase Margin	Specified Temp. Range 8 $\Omega$ Load		20			*		Degrees
<b>OUTPUT</b>								
Voltage Swing <sup>(1)</sup>	BM at 10A, SM at 15A Specified Temp. Range	$\pm( V_S  - 6)$			$\pm( V_S  - 7)$			V
Current, Peak	$I_O = 80\text{mA}$	$\pm( V_S  - 5)$			*			V
	$I_O = 5\text{A}$	$\pm( V_S  - 5)$			15			A
Settling Time to 0.1%	2V Step	10	2		*	*		$\mu\text{s}$
Slew Rate	Specified Temp. Range	2.5	4		*	*		V/ $\mu\text{s}$
Capacitive Load	Specified Temp. Range G = 1			1.5			*	nF
	Specified Temp. Range G > 10			SOA <sup>(2)</sup>			*	
<b>POWER SUPPLY</b>								
Voltage	Specified Temp. Range	$\pm 10$	$\pm 40$	$\pm 45$	*	*	$\pm 50$	V
Current, Quiescent			25	50		*	35	mA
<b>THERMAL RESISTANCE</b>								
AC Junction-to-Case <sup>(3)</sup>	$T_C = -55^\circ\text{C}$ to $+125^\circ\text{C}$ , $f > 60\text{Hz}$		0.8	0.9		*	*	$^\circ\text{C}/\text{W}$
DC Junction-to-Case	$T_C = -55^\circ\text{C}$ to $+125^\circ\text{C}$		1.25	1.4		*	*	$^\circ\text{C}/\text{W}$
Junction to Air	$T_C = -55^\circ\text{C}$ to $+125^\circ\text{C}$		30			*		$^\circ\text{C}/\text{W}$
<b>TEMPERATURE RANGE</b>								
Specified	$T_C$	-25		+85	-55		+125	$^\circ\text{C}$

\*Specification same as OPA512BM.

NOTES: (1)  $+V_S$  and  $-V_S$  denote the positive and negative supply voltage, respectively. Total  $V_S$  is measured from  $+V_S$  to  $-V_S$ . (2) SOA = Safe Operating Area.

(3) Rating applies if the output current alternates between both output transistors at a rate faster than 60Hz.

The information provided herein is believed to be reliable; however, BURR-BROWN assumes no responsibility for inaccuracies or omissions. BURR-BROWN assumes no responsibility for the use of this information, and all use of such information shall be entirely at the user's own risk. Prices and specifications are subject to change without notice. No patent rights or licenses to any of the circuits described herein are implied or granted to any third party. BURR-BROWN does not authorize or warrant any BURR-BROWN product for use in life support devices and/or systems.



## ABSOLUTE MAXIMUM RATINGS

Supply Voltage, $+V_S$ to $-V_S$ .....	100V
Output Current: Source .....	15A
Sink .....	see SOA
Power Dissipation, Internal <sup>(1)</sup> .....	125W
Input Voltage: Differential .....	$\pm( V_S  - 3V)$
Common-mode .....	$\pm V_S$
Temperature: Pins (soldering, 10s) .....	+300°C
Junction <sup>(1)</sup> .....	+200°C
Temperature Range: Storage <sup>(2)</sup> .....	-65°C to +150°C
Operating (Case) .....	-55°C to +125°C

NOTES: (1) Long term operation at the maximum junction temperature will result in reduced product life. Derate internal power dissipation to achieve high MTTF. (2) OPA512BM, -55°C to +100°C.

## CONNECTION DIAGRAM

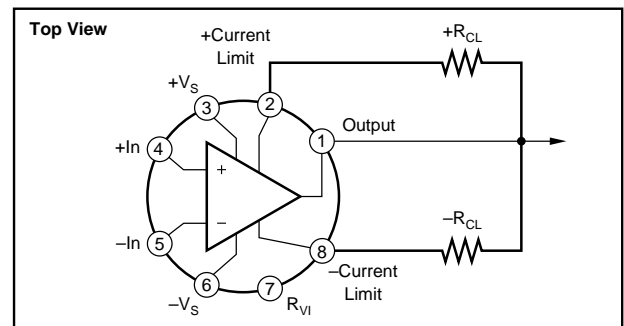

## ORDERING INFORMATION

MODEL	PACKAGE	TEMPERATURE RANGE
OPA512BM	8-pin TO-3	-25°C to +85°C
OPA512SM	8-pin TO-3	-55°C to +125°C

## PACKAGE INFORMATION

MODEL	PACKAGE	PACKAGE DRAWING NUMBER <sup>(1)</sup>
OPA512BM	8-Pin TO-3	030
OPA512SM	8-Pin TO-3	030

NOTE: (1) For detailed drawing and dimension table, please see end of data sheet, or Appendix D of Burr-Brown IC Data Book.

# TYPICAL PERFORMANCE CURVES

$T_A = 25^\circ\text{C}$ ,  $V_S = \pm 40\text{VDC}$ , unless otherwise noted.

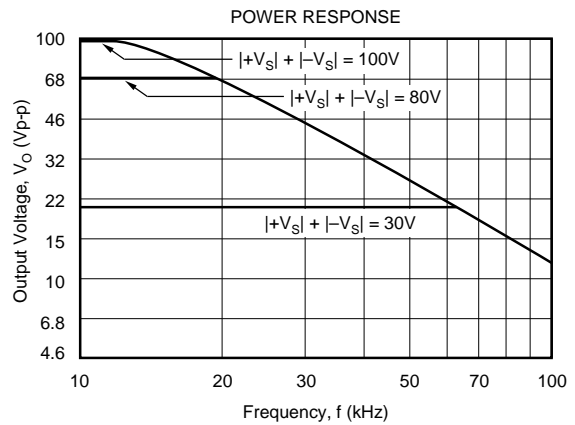
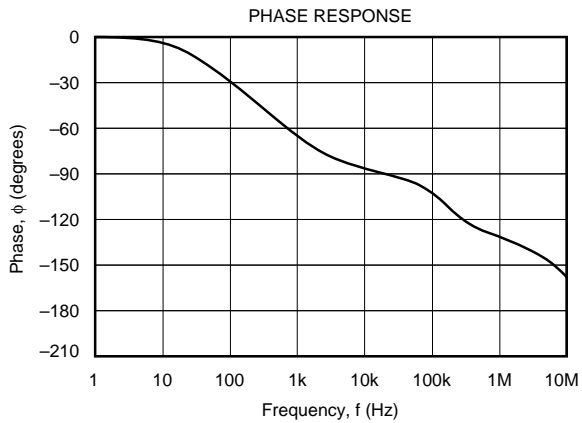
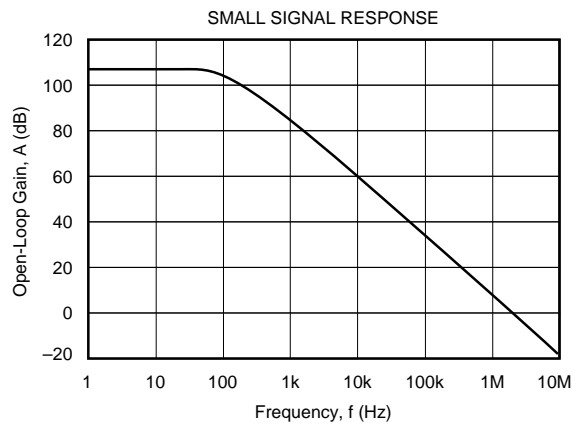
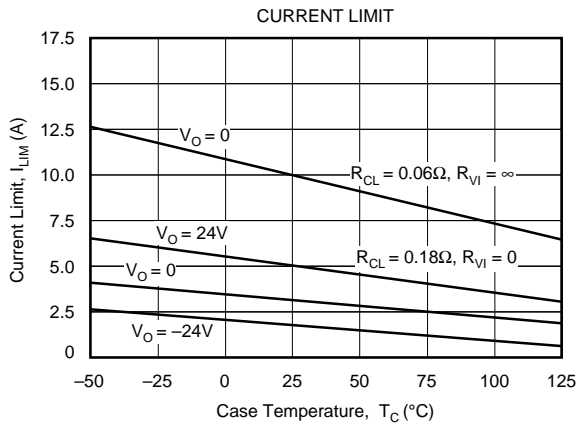
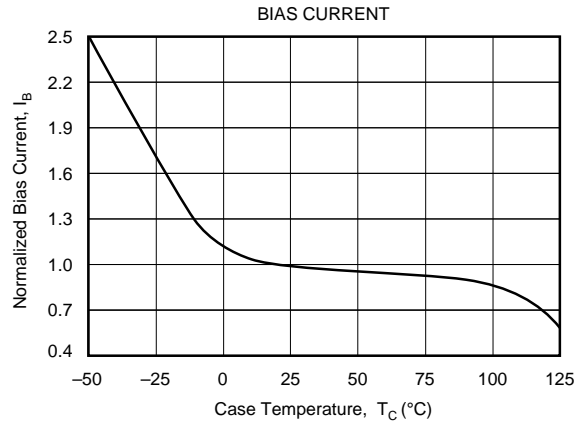
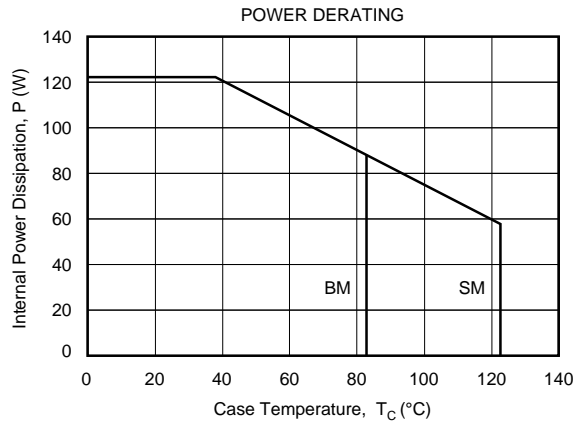

# TYPICAL PERFORMANCE CURVES (CONT)

$T_A = 25^\circ\text{C}$ ,  $V_S = \pm 40\text{VDC}$ , unless otherwise noted.

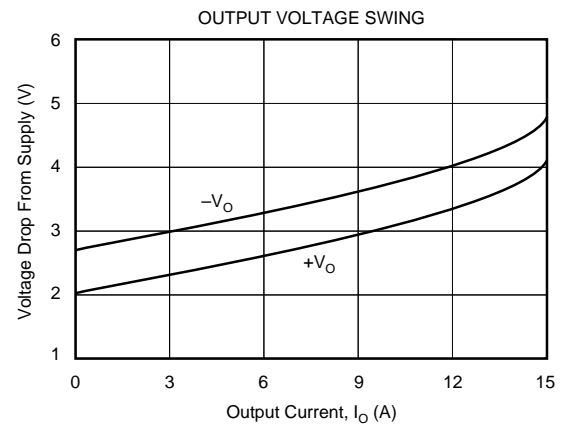
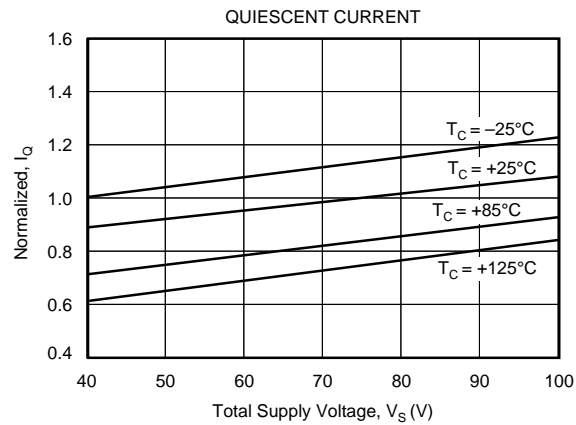
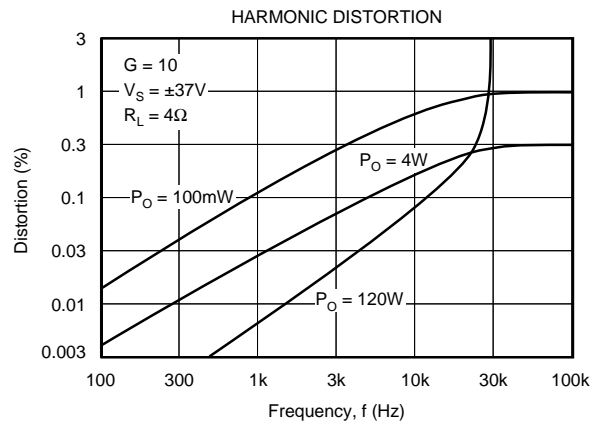
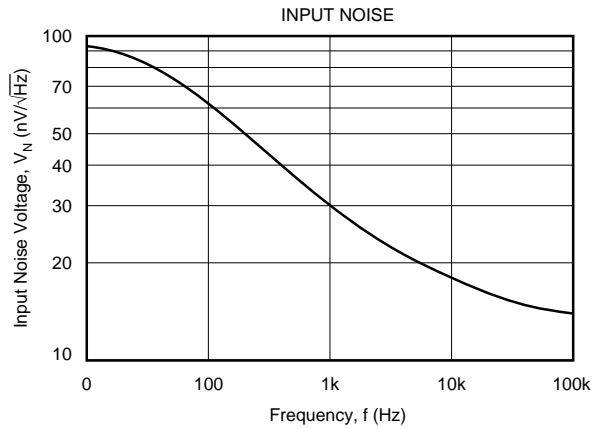
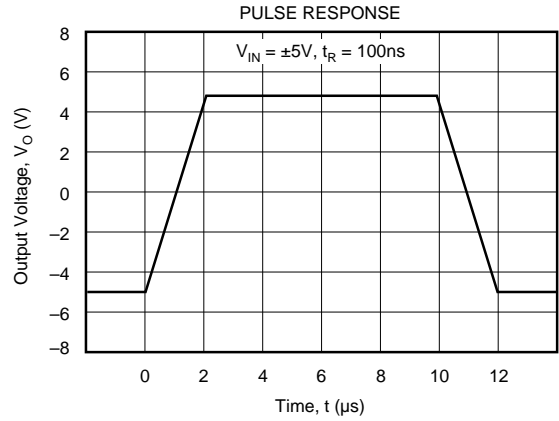
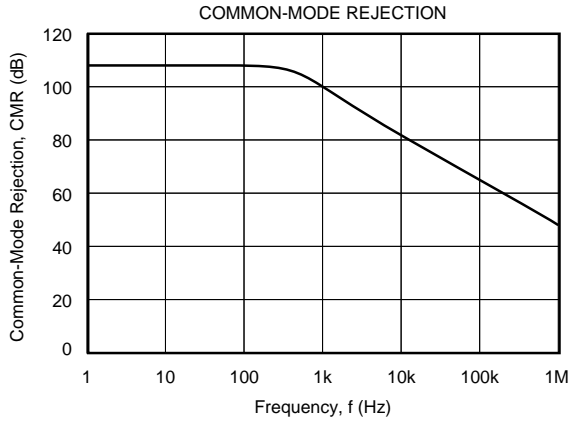

# APPLICATIONS INFORMATION

## POWER SUPPLIES

Specifications for the OPA512 are based on a nominal operating voltage of  $\pm 40\text{V}$ . A single power supply or unbalanced supplies may be used as long as the maximum total operating voltage (total of  $+V_S$  and  $-V_S$ ) is not greater than 90V (100V for OPA512SM model.)

## CURRENT LIMITS

Current limit resistors must be provided for proper operation. Independent positive and negative current limit values may be selected by choice of  $R_{CL+}$  and  $R_{CL-}$ , respectively. Resistor values are calculated by:

$$R_{CL} = 0.65/I_{LIM} \text{ (amps)} - 0.007$$

This is the nominal current limit value at room temperature. The maximum output current decreases at high temperature as shown in the typical performance curve. Most wire-wound resistors are satisfactory, but some highly inductive types may cause loop stability problems. Be sure to evaluate performance with the actual resistors to be used in production.

## HEAT SINKING

Power amplifiers are rated by case temperature (not ambient temperature.) The maximum allowable power dissipation is a function of the case temperature as shown in the power derating curve. Load characteristics, signal conditions, and power supply voltage determine the power dissipated by the amplifier. The case temperature will be determined by the heat sinking conditions. Sufficient heat sinking must be provided to keep the case temperature within safe bounds given the power dissipated and ambient temperature. See Application Bulletin AB-038 for further details.

## SAFE OPERATING AREA (SOA)

The safe area plot provides a comprehensive summary of the power handling limitations of a power amplifier, including maximum current, voltage and power as well as the secondary breakdown region (see Figure 1) It shows the allowable output current as a function of the power supply to output voltage differential (voltage across the conducting power device.) See Application Bulletin AB-039 for details on SOA.

## VOLTAGE-CURRENT LIMITER CIRCUITRY

The voltage-current (V-I) limiter circuit provides a means to protect the amplifier from SOA damage such as a short circuit to ground, yet allows high output currents to flow

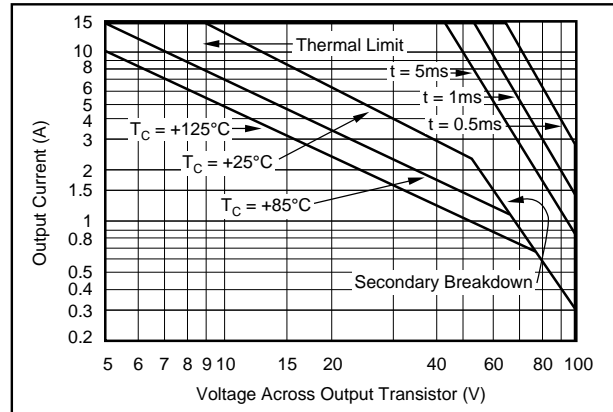

FIGURE 1. Safe Operating Area.

under normal load conditions. Sensing both the output current and the output voltage, this limiter circuit increases the current limit value as the output voltage approaches the power supply voltage (where power dissipation is low.) This type of limiting is achieved by connecting pin 7 through a programming resistor to ground. The V-I limiter circuit is governed by the equation:

$$I_{LIMIT} = \frac{0.65 + \frac{0.28 V_o}{20 + R_{VI}}}{R_{CL} + 0.007}$$

where:

$I_{LIMIT}$  is the maximum current available at a given output voltage.

$R_{VI}$  is the value (k $\Omega$ ) of the resistor from pin 7 to ground.

$R_{CL}$  is the current limit resistor in ohms.

$V_o$  is the instantaneous output voltage in volts.

Reactive or EMF-generating loads may produce unusual (perhaps undesirable) waveforms with the V-I limit circuit driven into limit. Since current peaks in a reactive load do not align with the output voltage peaks, the output waveform will not appear as a simple voltage-limited waveform. Response of the load to the limiter, in fact, may produce a “backfire” reaction producing unusual output waveforms.

---

## PACKAGING INFORMATION

ORDERABLE DEVICE	STATUS(1)	PACKAGE TYPE	PACKAGE DRAWING	PINS	PACKAGE QTY
OPA512BM	NRND	TO/SOT	LMF	8	18
OPA512SM	NRND	TO/SOT	LMF	8	18

(1) The marketing status values are defined as follows:

**ACTIVE:** Product device recommended for new designs.

**LIFEBUY:** TI has announced that the device will be discontinued, and a lifetime-buy period is in effect.

**NRND:** Not recommended for new designs. Device is in production to support existing customers, but TI does not recommend using this part in a new design.

**PREVIEW:** Device has been announced but is not in production. Samples may or may not be available.

**OBSOLETE:** TI has discontinued the production of the device.

---

## IMPORTANT NOTICE

Texas Instruments Incorporated and its subsidiaries (TI) reserve the right to make corrections, modifications, enhancements, improvements, and other changes to its products and services at any time and to discontinue any product or service without notice. Customers should obtain the latest relevant information before placing orders and should verify that such information is current and complete. All products are sold subject to TI's terms and conditions of sale supplied at the time of order acknowledgment.

TI warrants performance of its hardware products to the specifications applicable at the time of sale in accordance with TI's standard warranty. Testing and other quality control techniques are used to the extent TI deems necessary to support this warranty. Except where mandated by government requirements, testing of all parameters of each product is not necessarily performed.

TI assumes no liability for applications assistance or customer product design. Customers are responsible for their products and applications using TI components. To minimize the risks associated with customer products and applications, customers should provide adequate design and operating safeguards.

TI does not warrant or represent that any license, either express or implied, is granted under any TI patent right, copyright, mask work right, or other TI intellectual property right relating to any combination, machine, or process in which TI products or services are used. Information published by TI regarding third-party products or services does not constitute a license from TI to use such products or services or a warranty or endorsement thereof. Use of such information may require a license from a third party under the patents or other intellectual property of the third party, or a license from TI under the patents or other intellectual property of TI.

Reproduction of information in TI data books or data sheets is permissible only if reproduction is without alteration and is accompanied by all associated warranties, conditions, limitations, and notices. Reproduction of this information with alteration is an unfair and deceptive business practice. TI is not responsible or liable for such altered documentation.

Resale of TI products or services with statements different from or beyond the parameters stated by TI for that product or service voids all express and any implied warranties for the associated TI product or service and is an unfair and deceptive business practice. TI is not responsible or liable for any such statements.

Following are URLs where you can obtain information on other Texas Instruments products and application solutions:

<b>Products</b>		<b>Applications</b>	
Amplifiers	<a href="http://amplifier.ti.com">amplifier.ti.com</a>	Audio	<a href="http://www.ti.com/audio">www.ti.com/audio</a>
Data Converters	<a href="http://dataconverter.ti.com">dataconverter.ti.com</a>	Automotive	<a href="http://www.ti.com/automotive">www.ti.com/automotive</a>
DSP	<a href="http://dsp.ti.com">dsp.ti.com</a>	Broadband	<a href="http://www.ti.com/broadband">www.ti.com/broadband</a>
Interface	<a href="http://interface.ti.com">interface.ti.com</a>	Digital Control	<a href="http://www.ti.com/digitalcontrol">www.ti.com/digitalcontrol</a>
Logic	<a href="http://logic.ti.com">logic.ti.com</a>	Military	<a href="http://www.ti.com/military">www.ti.com/military</a>
Power Mgmt	<a href="http://power.ti.com">power.ti.com</a>	Optical Networking	<a href="http://www.ti.com/opticalnetwork">www.ti.com/opticalnetwork</a>
Microcontrollers	<a href="http://microcontroller.ti.com">microcontroller.ti.com</a>	Security	<a href="http://www.ti.com/security">www.ti.com/security</a>
		Telephony	<a href="http://www.ti.com/telephony">www.ti.com/telephony</a>
		Video & Imaging	<a href="http://www.ti.com/video">www.ti.com/video</a>
		Wireless	<a href="http://www.ti.com/wireless">www.ti.com/wireless</a>

Mailing Address: Texas Instruments  
Post Office Box 655303 Dallas, Texas 75265

Copyright © 2003, Texas Instruments Incorporated

## Looking for pricing, stock, or lifecycle information?

Click below to explore more details on WIN SOURCE:

 [View OPA512BM](#) on WIN SOURCE

 [Texas Instruments](#) Information

## Optimize Your Supply Chain with WIN SOURCE Solutions

-  Global Sourcing Solution
-  Obsolete Management
-  Cost Control Management
-  Shortage Management
-  Alternative Solution
-  Excess Inventory Management