



THE DATASHEET OF DAC7552IRGTT



12-BIT, DUAL, ULTRALOW GLITCH, VOLTAGE OUTPUT DIGITAL-TO-ANALOG CONVERTER

Check for Samples: [DAC7552](#)

FEATURES

- 2.7-V to 5.5-V Single Supply
- 12-Bit Linearity and Monotonicity
- Rail-to-Rail Voltage Output
- Settling Time: 5 μ s (Max)
- Ultralow Glitch Energy: 0.1 nVs
- Ultralow Crosstalk: –100 dB
- Low Power: 440 μ A (Max)
- Per-Channel Power Down: 2 μ A (Max)
- Power-On Reset to Zero Scale
- SPI-Compatible Serial Interface: Up to 50 MHz
- Daisy-Chain Capability
- Asynchronous Hardware Clear
- Simultaneous or Sequential Update
- Specified Temperature Range: –40°C to 105°C
- Small 3-mm \times 3-mm, 16-Lead QFN Package

APPLICATIONS

- Portable Battery-Powered Instruments
- Digital Gain and Offset Adjustment
- Programmable Voltage and Current Sources
- Programmable Attenuators
- Industrial Process Control

DESCRIPTION

The DAC7552 is a 12-bit, dual-channel, voltage-output DAC with exceptional linearity and monotonicity. Its proprietary architecture minimizes undesired transients such as code-to-code glitch and channel-to-channel crosstalk. The low-power DAC7552 operates from a single 2.7-V to 5.5-V supply. The DAC7552 output amplifiers can drive a 2-k Ω , 200-pF load rail-to-rail with 5- μ s settling time; the output range is set using an external voltage reference.

The 3-wire serial interface operates at clock rates up to 50 MHz and is compatible with SPI, QSPI, Microwire™, and DSP interface standards. The outputs of all DACs may be updated simultaneously or sequentially. The parts incorporate a power-on-reset circuit to ensure that the DAC outputs power up to zero volts and remain there until a valid write cycle to the device takes place. The parts contain a power-down feature that reduces the current consumption of the device to under 2 μ A.

The small size and low-power operation makes the DAC7552 ideally suited for battery-operated portable applications. The power consumption is typically 1.5 mW at 5 V, 0.75 mW at 3 V, and reduces to 1 μ W in power-down mode.

The DAC7552 is available in a 16-lead QFN package and is specified over –40°C to 105°C.

FUNCTIONAL BLOCK DIAGRAM

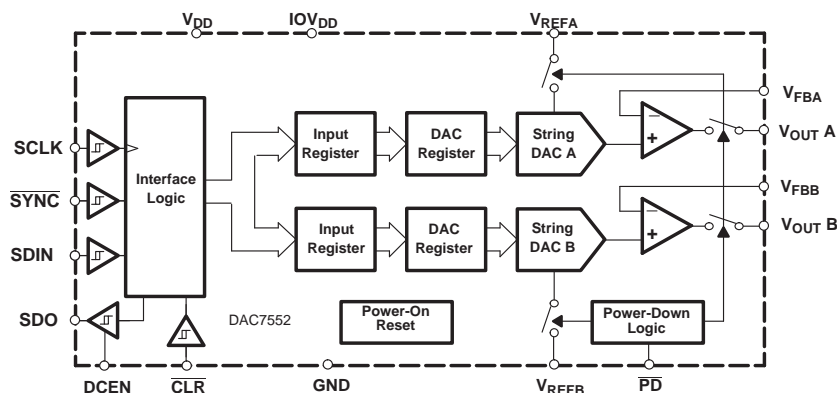

Please be aware that an important notice concerning availability, standard warranty, and use in critical applications of Texas Instruments semiconductor products and disclaimers thereto appears at the end of this data sheet.

Microwire is a trademark of National Semiconductor Corporation.



This integrated circuit can be damaged by ESD. Texas Instruments recommends that all integrated circuits be handled with appropriate precautions. Failure to observe proper handling and installation procedures can cause damage.

ESD damage can range from subtle performance degradation to complete device failure. Precision integrated circuits may be more susceptible to damage because very small parametric changes could cause the device not to meet its published specifications.

ORDERING INFORMATION⁽¹⁾

PRODUCT	PACKAGE	PACKAGE DESIGNATOR	SPECIFIED TEMPERATURE RANGE	PACKAGE MARKING	ORDERING NUMBER	TRANSPORT MEDIA
DAC7552	16 QFN	RGT	–40°C TO 105°C	D752	DAC7552IRGTT	250-piece Tape and Reel
					DAC7552IRGTR	3000-piece Tape and Reel

(1) For the most current package and ordering information, see the Package Option Addendum at the end of this document, or see the TI website at www.ti.com.

ABSOLUTE MAXIMUM RATINGS

over operating free-air temperature range (unless otherwise noted)⁽¹⁾

	UNIT
V _{DD} , IOV _{DD} to GND	–0.3 V to 6 V
Digital input voltage to GND	–0.3 V to V _{DD} + 0.3 V
V _{OUT} to GND	–0.3 V to V _{DD} + 0.3 V
Operating temperature range	–40°C to 105°C
Storage temperature range	–65°C to 150°C
Junction temperature (T _J Max)	150°C

(1) Stresses above those listed under “Absolute Maximum Ratings” may cause permanent damage to the device. Exposure to absolute maximum conditions for extended periods may affect device reliability.

ELECTRICAL CHARACTERISTICS

V_{DD} = 2.7 V to 5.5 V, V_{REF} = V_{DD}, R_L = 2 kΩ to GND; C_L = 200 pF to GND; all specifications –40°C to 105°C, unless otherwise specified

PARAMETER	TEST CONDITIONS	MIN	TYP	MAX	UNITS
STATIC PERFORMANCE⁽¹⁾					
Resolution			12		Bits
Relative accuracy			±0.35	±1	LSB
Differential nonlinearity	Specified monotonic by design		±0.08	±0.5	LSB
Offset error				±12	mV
Zero-scale error	All zeroes loaded to DAC register			±12	mV
Gain error				±0.15	%FSR
Full-scale error				±0.5	%FSR
Zero-scale error drift			7		µV/°C
Gain temperature coefficient			3		ppm of FSR/°C
PSRR	V _{DD} = 5 V		0.75		mV/V

(1) Linearity tested using a reduced code range of 30 to 4065; output unloaded.

ELECTRICAL CHARACTERISTICS (continued)

$V_{DD} = 2.7\text{ V to }5.5\text{ V}$, $V_{REF} = V_{DD}$, $R_L = 2\text{ k}\Omega$ to GND; $C_L = 200\text{ pF}$ to GND; all specifications $-40^\circ\text{C to }105^\circ\text{C}$, unless otherwise specified

PARAMETER	TEST CONDITIONS	MIN	TYP	MAX	UNITS
OUTPUT CHARACTERISTICS⁽²⁾					
Output voltage range		0		VREF	V
Output voltage settling time	$R_L = 2\text{ k}\Omega$; $0\text{ pF} < C_L < 200\text{ pF}$			5	μs
Slew rate			1.8		$\text{V}/\mu\text{s}$
Capacitive load stability	$R_L = \infty$		470		pF
	$R_L = 2\text{ k}\Omega$		1000		
Digital-to-analog glitch impulse	1 LSB change around major carry		0.1		nV-s
Channel-to-channel crosstalk	1-kHz full-scale sine wave, outputs unloaded		-100		dB
Digital feedthrough			0.1		nV-s
Output noise density (10-kHz offset frequency)			120		nV/rtHz
Total harmonic distortion	$F_{OUT} = 1\text{ kHz}$, $F_S = 1\text{ MSPS}$, $BW = 20\text{ kHz}$		-85		dB
DC output impedance			1		Ω
Short-circuit current	$V_{DD} = 5\text{ V}$		50		mA
	$V_{DD} = 3\text{ V}$		20		
Power-up time	Coming out of power-down mode, $V_{DD} = 5\text{ V}$		15		μs
	Coming out of power-down mode, $V_{DD} = 3\text{ V}$		15		
REFERENCE INPUT					
VREF Input range		0		V_{DD}	V
Reference input impedance	V_{REFA} and V_{REFB} shorted together		50		$\text{k}\Omega$
Reference current	$V_{REFA} = V_{REFB} = V_{DD} = 5\text{ V}$, V_{REFA} and V_{REFB} shorted together		100	250	μA
	$V_{REFA} = V_{REFB} = V_{DD} = 3\text{ V}$, V_{REFA} and V_{REFB} shorted together		60	123	
LOGIC INPUTS⁽²⁾					
Input current				± 1	μA
V_{IN_L} , Input low voltage	$\text{IOV}_{DD} \geq 2.7\text{ V}$			0.3 IOV_{DD}	V
V_{IN_H} , Input high voltage	$\text{IOV}_{DD} \geq 2.7\text{ V}$	0.7 IOV_{DD}			V
Pin capacitance				3	pF
POWER REQUIREMENTS					
V_{DD} , IOV_{DD} ⁽³⁾		2.7		5.5	V
I_{DD} (normal operation) $V_{DD} = 3.6\text{ V to }5.5\text{ V}$	DAC active and excluding load current $V_{IH} = \text{IOV}_{DD}$ and $V_{IL} = \text{GND}$		300	440	μA
		$V_{DD} = 2.7\text{ V to }3.6\text{ V}$	250	400	
I_{DD} (all power-down modes) $V_{DD} = 3.6\text{ V to }5.5\text{ V}$	$V_{IH} = \text{IOV}_{DD}$ and $V_{IL} = \text{GND}$		0.2	2	μA
		$V_{DD} = 2.7\text{ V to }3.6\text{ V}$	0.05	2	
POWER EFFICIENCY					
I_{OUT}/I_{DD}	$I_{LOAD} = 2\text{ mA}$, $V_{DD} = 5\text{ V}$		93%		

(2) Specified by design and characterization, not production tested. For $1.8\text{ V} < \text{IOV}_{DD} < 2.7\text{ V}$, It is recommended that $V_{IH} = \text{IOV}_{DD}$, $V_{IL} = \text{GND}$.

(3) IOV_{DD} operates down to 1.8 V with slightly degraded timing, as long as $V_{IH} = \text{IOV}_{DD}$ and $V_{IL} = \text{GND}$.

TIMING CHARACTERISTICS^{(1) (2)}

$V_{DD} = 2.7\text{ V to }5.5\text{ V}$, $R_L = 2\text{ k}\Omega$ to GND; all specifications $-40^\circ\text{C to }105^\circ\text{C}$, unless otherwise specified

PARAMETER		TEST CONDITIONS	MIN	TYP	MAX	UNITS
$t_1^{(3)}$	SCLK cycle time	$V_{DD} = 2.7\text{ V to }3.6\text{ V}$	20			ns
		$V_{DD} = 3.6\text{ V to }5.5\text{ V}$	20			
t_2	SCLK HIGH time	$V_{DD} = 2.7\text{ V to }3.6\text{ V}$	10			ns
		$V_{DD} = 3.6\text{ V to }5.5\text{ V}$	10			
t_3	SCLK LOW time	$V_{DD} = 2.7\text{ V to }3.6\text{ V}$	10			ns
		$V_{DD} = 3.6\text{ V to }5.5\text{ V}$	10			
t_4	$\overline{\text{SYNC}}$ falling edge to SCLK falling edge setup time	$V_{DD} = 2.7\text{ V to }3.6\text{ V}$	4			ns
		$V_{DD} = 3.6\text{ V to }5.5\text{ V}$	4			
t_5	Data setup time	$V_{DD} = 2.7\text{ V to }3.6\text{ V}$	5			ns
		$V_{DD} = 3.6\text{ V to }5.5\text{ V}$	5			
t_6	Data hold time	$V_{DD} = 2.7\text{ V to }3.6\text{ V}$	4.5			ns
		$V_{DD} = 3.6\text{ V to }5.5\text{ V}$	4.5			
t_7	SCLK falling edge to $\overline{\text{SYNC}}$ rising edge	$V_{DD} = 2.7\text{ V to }3.6\text{ V}$	0			ns
		$V_{DD} = 3.6\text{ V to }5.5\text{ V}$	0			
t_8	Minimum $\overline{\text{SYNC}}$ HIGH time	$V_{DD} = 2.7\text{ V to }3.6\text{ V}$	20			ns
		$V_{DD} = 3.6\text{ V to }5.5\text{ V}$	20			
t_9	SCLK falling edge to SDO valid	$V_{DD} = 2.7\text{ V to }3.6\text{ V}$	10			ns
		$V_{DD} = 3.6\text{ V to }5.5\text{ V}$	10			
t_{10}	$\overline{\text{CLR}}$ pulse width low	$V_{DD} = 2.7\text{ V to }3.6\text{ V}$	10			ns
		$V_{DD} = 3.6\text{ V to }5.5\text{ V}$	10			

- (1) All input signals are specified with $t_R = t_F = 1\text{ ns}$ (10% to 90% of V_{DD}) and timed from a voltage level of $(V_{IL} + V_{IH})/2$.
- (2) See Serial Write Operation timing diagram [Figure 1](#).
- (3) Maximum SCLK frequency is 50 MHz at $V_{DD} = 2.7\text{ V to }5.5\text{ V}$.

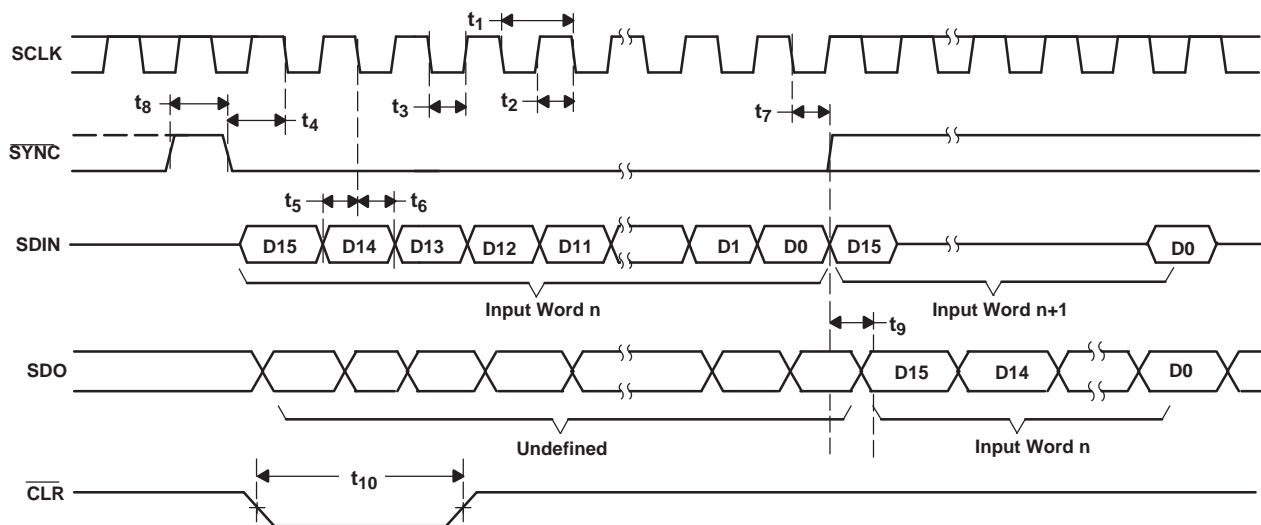
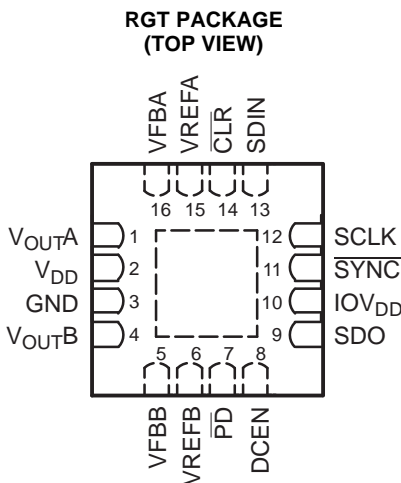

Figure 1. Serial Write Operation

PIN DESCRIPTION



Terminal Functions

TERMINAL		DESCRIPTION
NO.	NAME	
1	V _{OUTA}	Analog output voltage from DAC A
2	V _{DD}	Analog voltage supply input
3	GND ⁽¹⁾	Ground
4	V _{OUTB}	Analog output voltage from DAC B
5	VFBB	DAC B amplifier sense input. (For voltage output operation, connect to VOUTB externally.)
6	VREFB	Positive reference voltage input for DAC B
7	$\overline{\text{PD}}$	Power-down
8	DCEN	Daisy-chain enable
9	SDO	Serial data output
10	IOVDD	I/O voltage supply input. (For single supply operation, connect to VDD externally.)
11	$\overline{\text{SYNC}}$	Frame synchronization input. The falling edge of the $\overline{\text{SYNC}}$ pulse indicates the start of a serial data frame shifted out to the DAC7552
12	SCLK	Serial clock input
13	SDIN	Serial data input
14	$\overline{\text{CLR}}$	Asynchronous input to clear the DAC registers. When $\overline{\text{CLR}}$ is low, the DAC registers are set to 000H and the output voltage to 0 V.
15	VREFA	Positive reference voltage input for DAC A
16	VFBA	DAC A amplifier sense input. (For voltage output operation, connect to VOUTA externally.)

(1) Thermal pad should be connected to GND.

TYPICAL CHARACTERISTICS

LINEARITY ERROR AND DIFFERENTIAL LINEARITY ERROR VS DIGITAL INPUT CODE

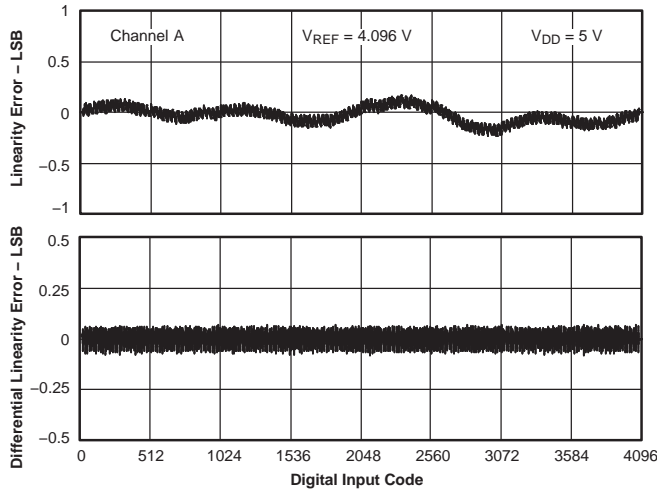

Figure 2.

LINEARITY ERROR AND DIFFERENTIAL LINEARITY ERROR VS DIGITAL INPUT CODE

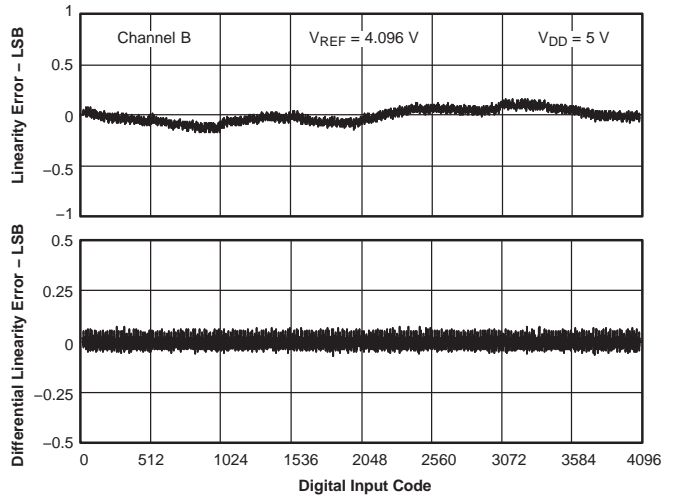

Figure 3.

LINEARITY ERROR AND DIFFERENTIAL LINEARITY ERROR VS DIGITAL INPUT CODE

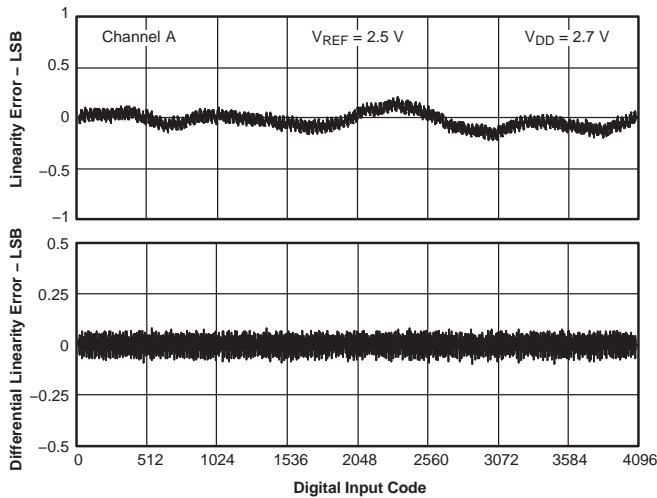

Figure 4.

LINEARITY ERROR AND DIFFERENTIAL LINEARITY ERROR VS DIGITAL INPUT CODE

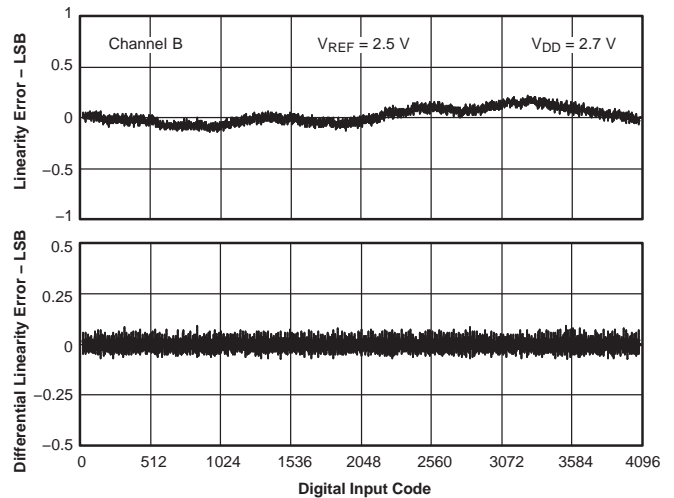

Figure 5.

TYPICAL CHARACTERISTICS (continued)

ZERO-SCALE ERROR
vs
FREE-AIR TEMPERATURE

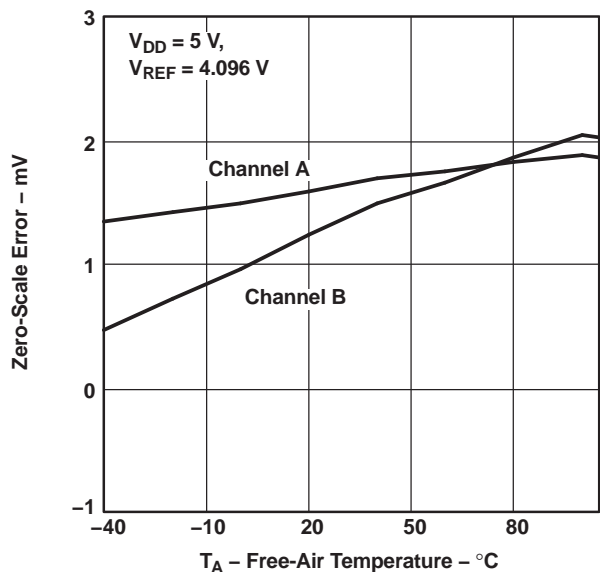

Figure 6.

ZERO-SCALE ERROR
vs
FREE-AIR TEMPERATURE

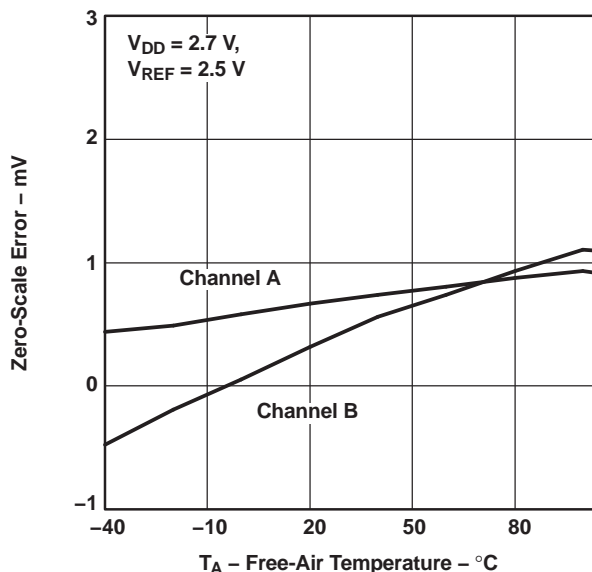

Figure 7.

FULL-SCALE ERROR
vs
FREE-AIR TEMPERATURE

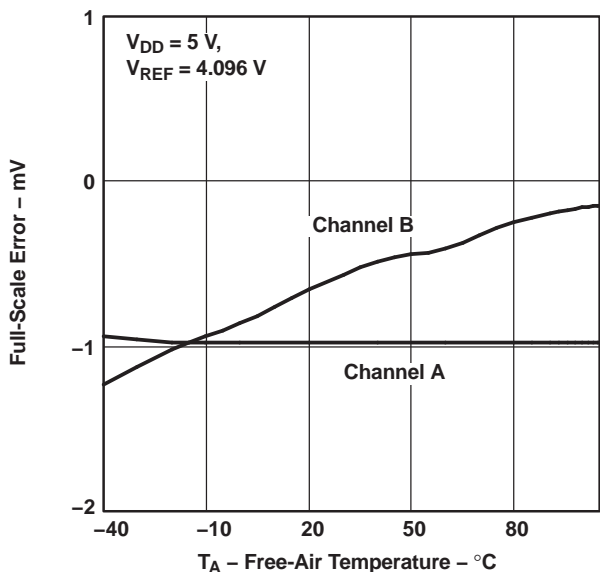

Figure 8.

FULL-SCALE ERROR
vs
FREE-AIR TEMPERATURE

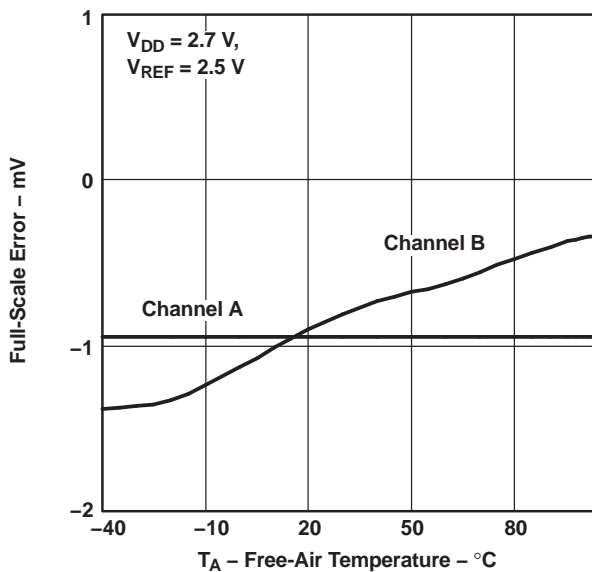

Figure 9.

TYPICAL CHARACTERISTICS (continued)

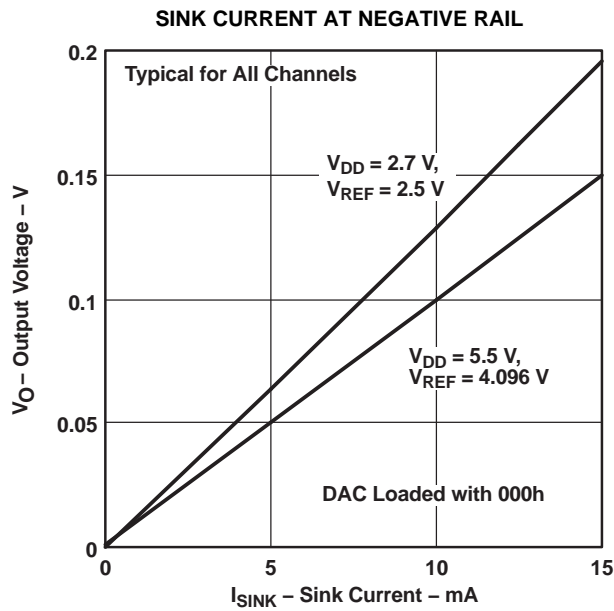

Figure 10.

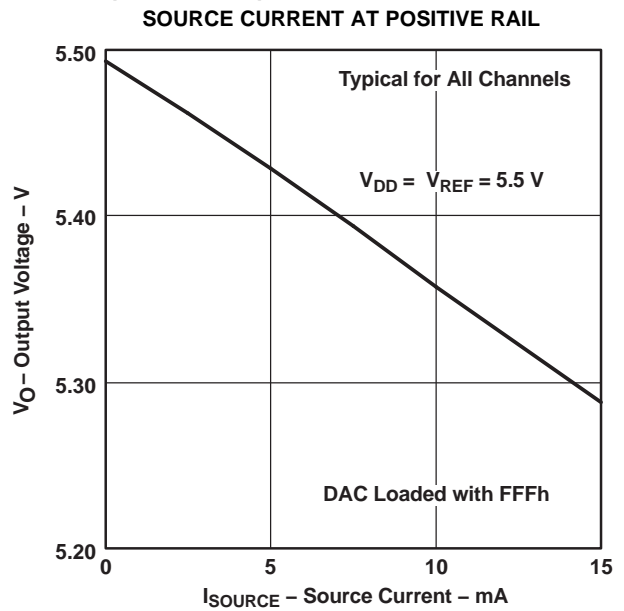

Figure 11.

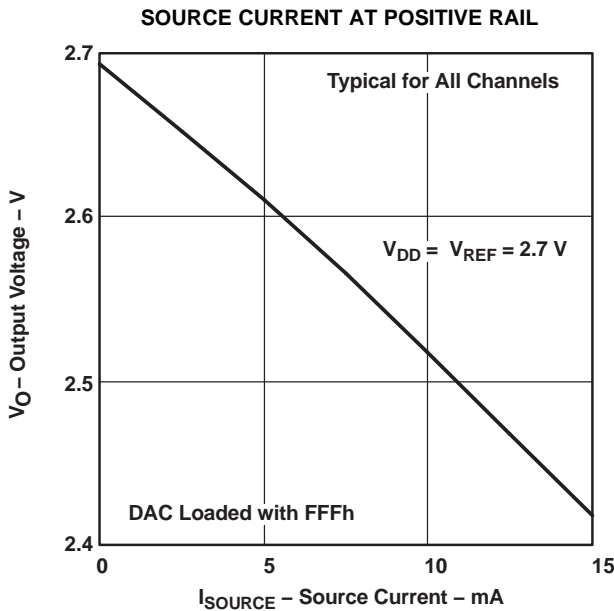

Figure 12.

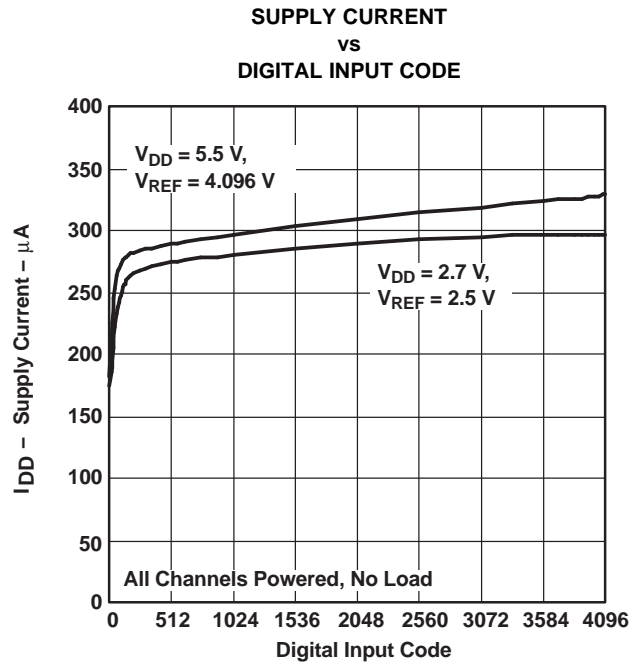

Figure 13.

TYPICAL CHARACTERISTICS (continued)

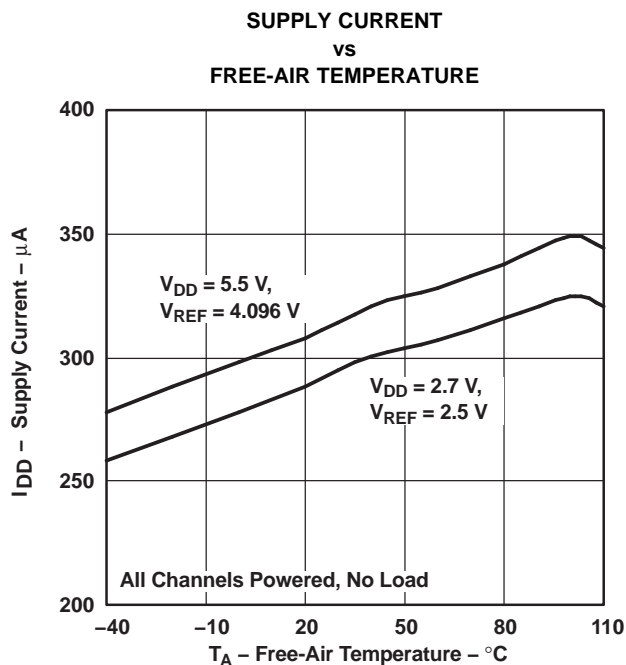

Figure 14.

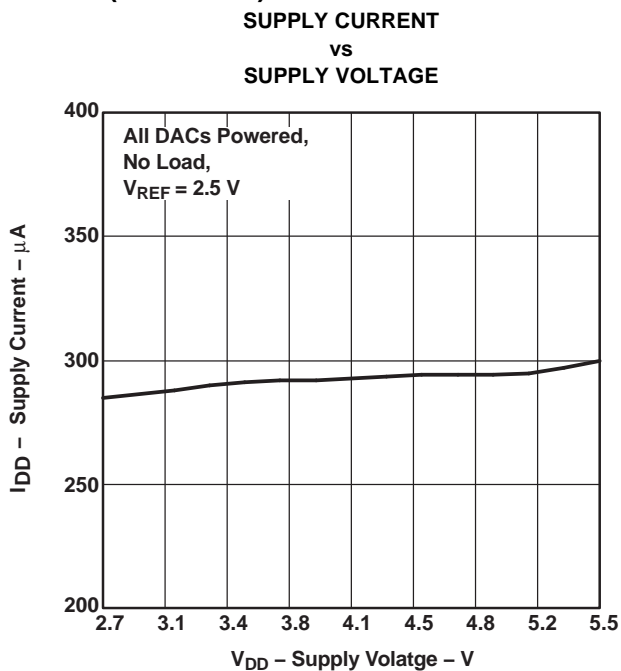

Figure 15.

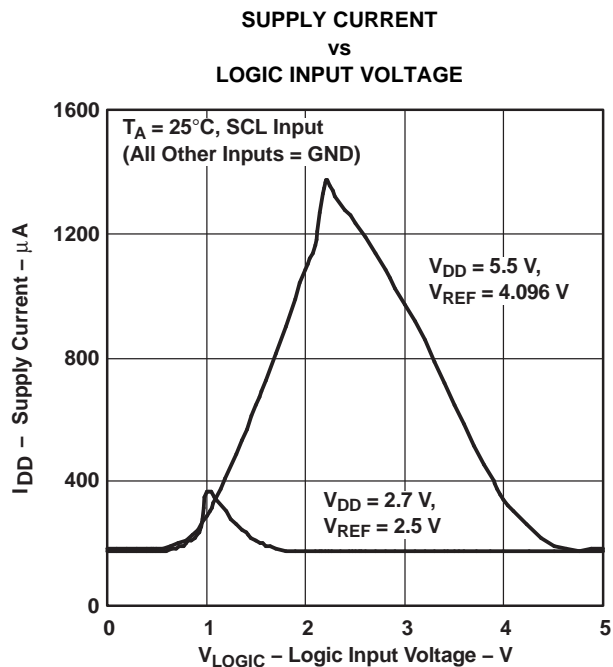

Figure 16.

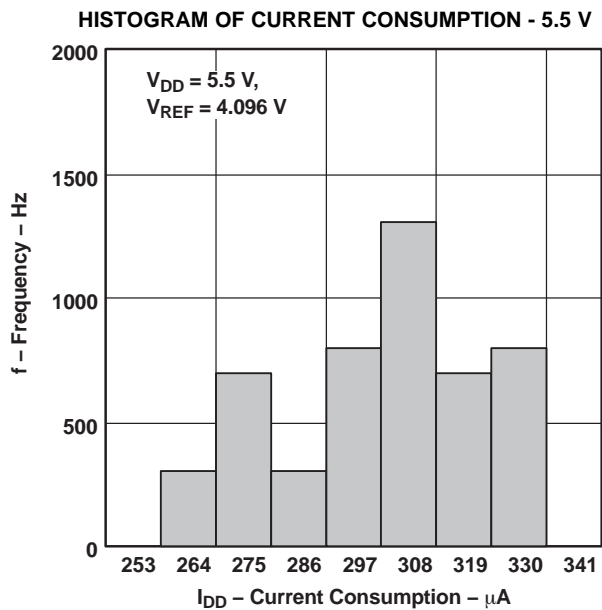

Figure 17.

TYPICAL CHARACTERISTICS (continued)

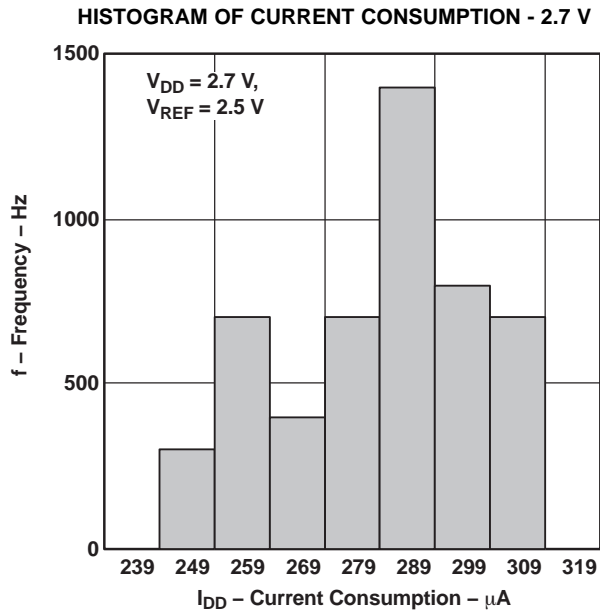

Figure 18.

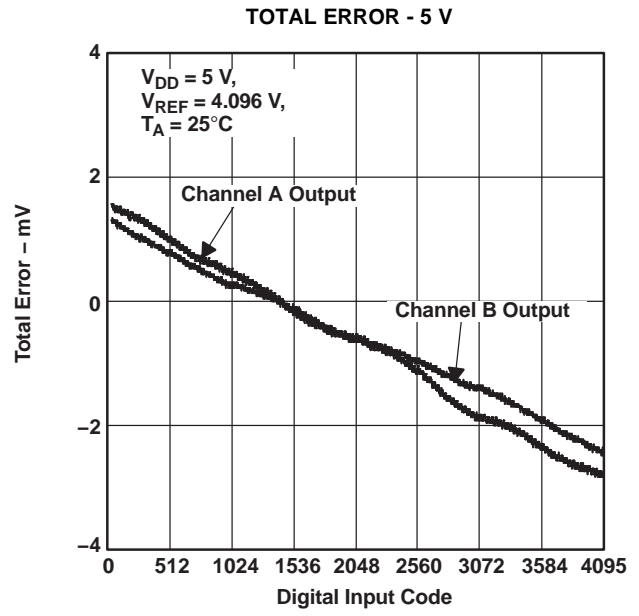

Figure 19.

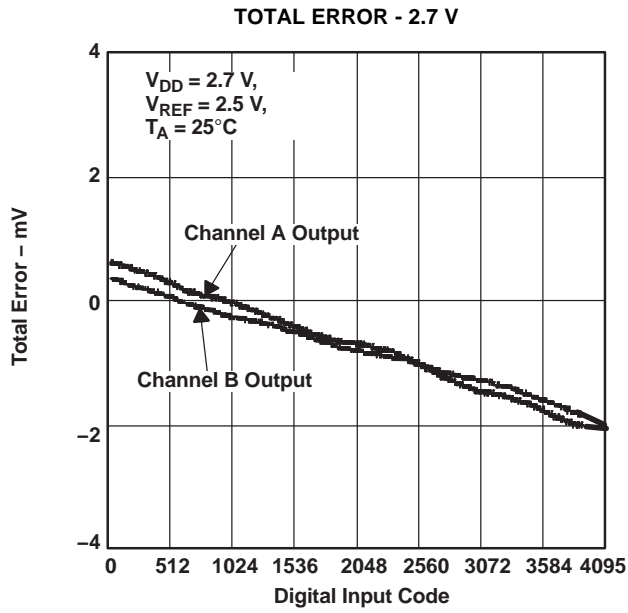

Figure 20.

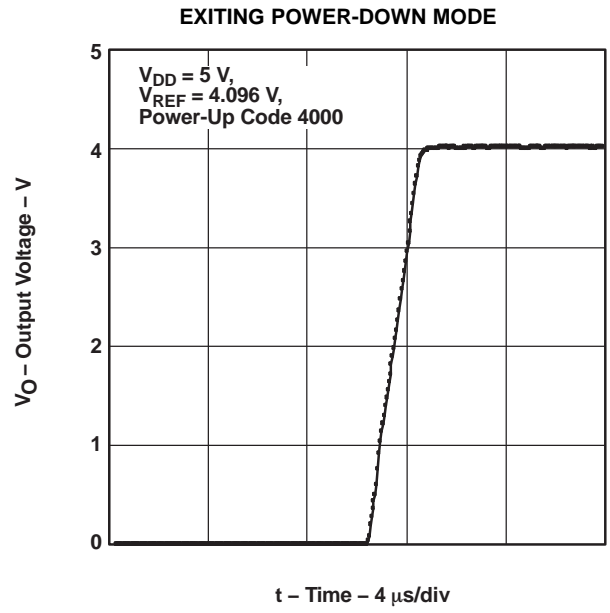
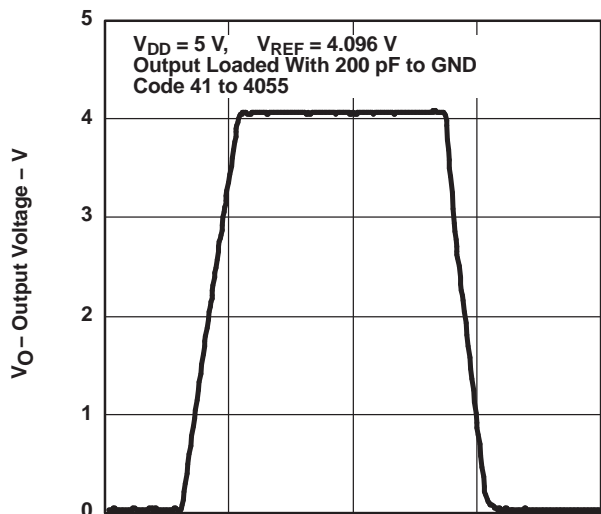

Figure 21.

TYPICAL CHARACTERISTICS (continued)

LARGE-SIGNAL SETTLING TIME - 5 V



t - Time - 5 μ s/div

Figure 22.

LARGE-SIGNAL SETTLING TIME - 2.7 V

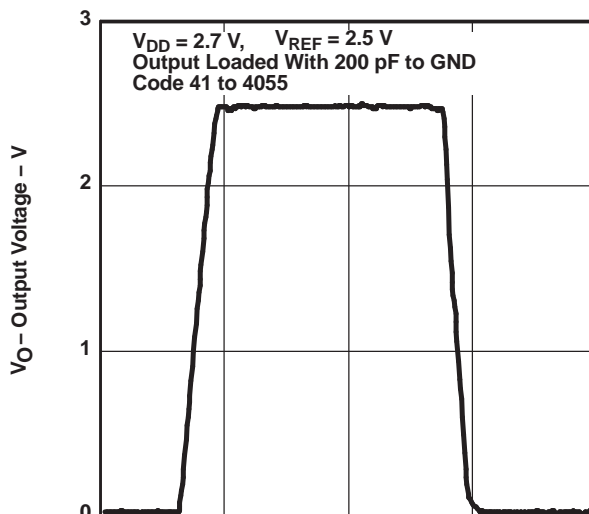

t - Time - 5 μ s/div

Figure 23.

MIDSCALE GLITCH

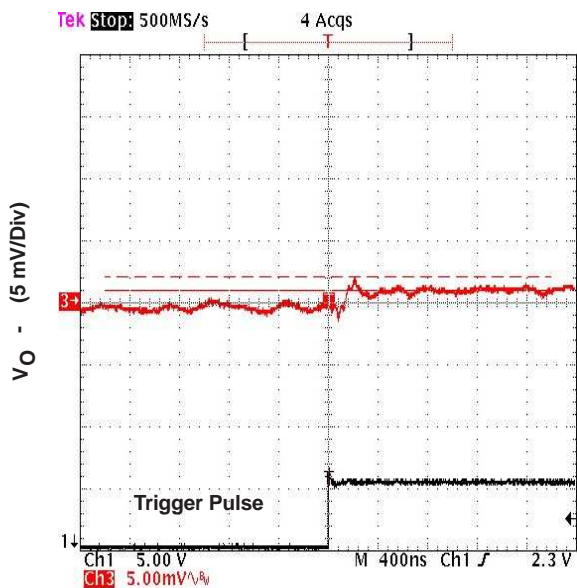

Time - (400 nS/Div)

Figure 24.

WORST-CASE GLITCH

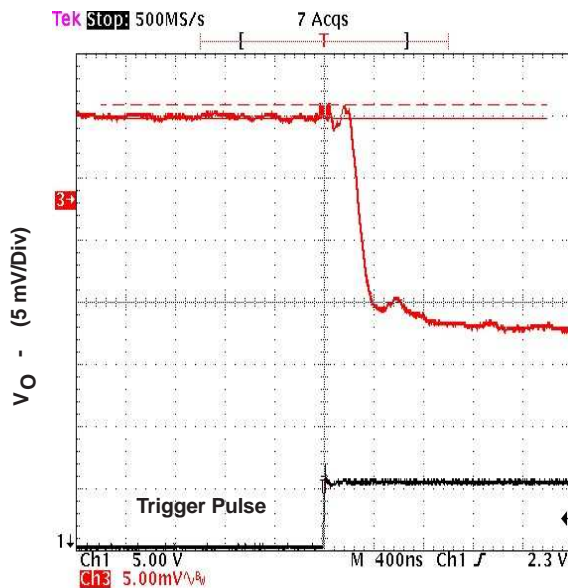

Time - (400 nS/Div)

Figure 25.

TYPICAL CHARACTERISTICS (continued)

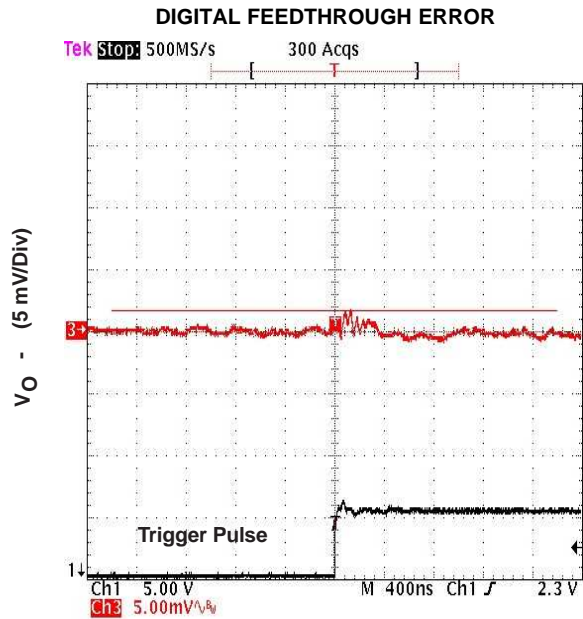

Time - (400 nS/Div)

Figure 26.

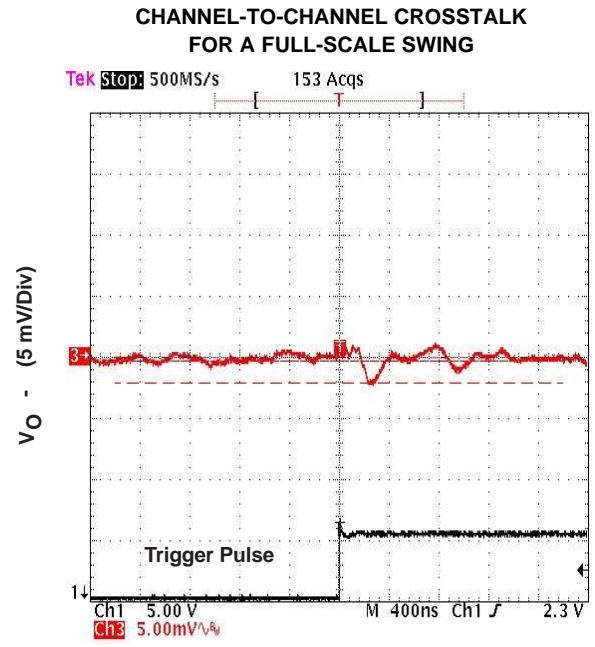

Time - (400 nS/Div)

Figure 27.

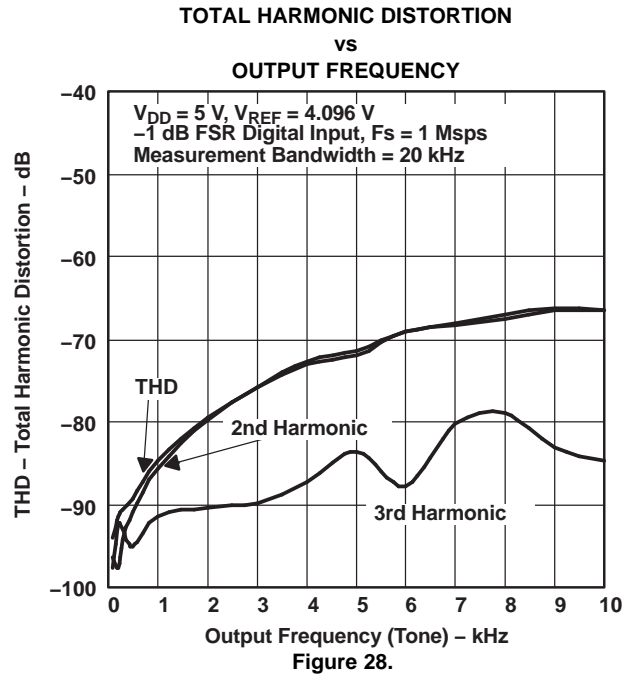

Figure 28.

TYPICAL CHARACTERISTICS (continued)
3-Wire Serial Interface

The DAC7552 digital interface is a standard 3-wire SPI/QSPI/Microwire/DSP-compatible interface.

Table 1. Serial Interface Programming

CONTROL				DATA BITS	DAC(s)	FUNCTION
DB15	DB14	DB13	DB12	DB11-DB10		
0	0	0	0	data	A	Single Channel Store. The input register of channel A is updated.
0	0	1	0	data	B	Single Channel Store. The input register of channel B is updated.
0	1	0	0	data	A	Single Channel Update. The input and DAC registers of channel A are updated.
0	1	1	0	data	A–B	Single Channel Update. The input and DAC registers of channel A are updated and the DAC register of channel B is updated with input register data.
1	0	0	0	data	B	Single Channel Update. The input and DAC registers of channel B are updated.
1	0	1	0	data	A–B	Single Channel Update. The input and DAC registers of channel B are updated and the DAC register of channel A is updated with input register data.
1	1	0	0	data	A–B	All Channel Update. The input and DAC registers of channels A and B are updated.
1	1	1	0	data	A–B	All Channel DAC Update. The DAC register of channels A and B are updated with input register data.

POWER-DOWN MODE

In power-down mode, the DAC outputs are programmed to one of three output impedances, 1 k Ω , 100 k Ω , or floating.

Table 2. Power-Down Mode Control

EXTENDED CONTROL				DATA BITS			FUNCTION
DB15	DB14	DB13	DB12	DB11	DB10	DB9-DB0	
0	0	X	1	0	0	X	PWD Hi-Z (all channels)
0	0	X	1	0	1	X	PWD 1 k Ω (all channels)
0	0	X	1	1	0	X	PWD 100 k Ω (all channels)
0	0	X	1	1	1	X	PWD Hi-Z (all channels)
0	1	X	1	0	0	X	PWD Hi-Z (selected channel = A)
0	1	X	1	0	1	X	PWD 1 k Ω (selected channel = A)
0	1	X	1	1	0	X	PWD 100 k Ω (selected channel = A)
0	1	X	1	1	1	X	PWD Hi-Z (selected channel = A)
1	0	X	1	0	0	X	PWD Hi-Z (selected channel = B)
1	0	X	1	0	1	X	PWD 1 k Ω (selected channel = B)
1	0	X	1	1	0	X	PWD 100 k Ω (selected channel = B)
1	0	X	1	1	1	X	PWD Hi-Z (selected channel = B)
1	1	X	1	0	0	X	PWD Hi-Z (all channels)
1	1	X	1	0	1	X	PWD 1 k Ω (all channels)
1	1	X	1	1	0	X	PWD 100 k Ω (all channels)
1	1	X	1	1	1	X	PWD Hi-Z (all channels)

THEORY OF OPERATION

D/A SECTION

The architecture of the DAC7552 consists of a string DAC followed by an output buffer amplifier. Figure 29 shows a generalized block diagram of the DAC architecture.

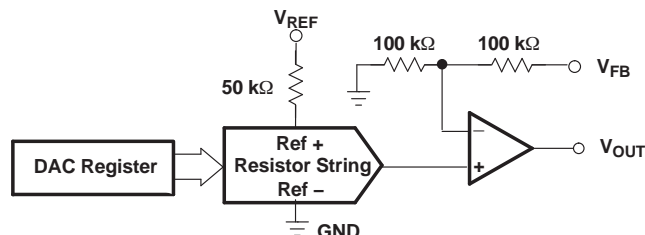

Figure 29. Typical DAC Architecture

The input coding to the DAC7552 is unsigned binary, which gives the ideal output voltage as:

$$V_{OUT} = V_{REF} \times D/4096$$

Where D = decimal equivalent of the binary code that is loaded to the DAC register which can range from 0 to 4095.

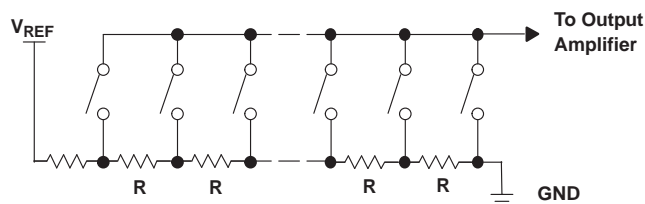

Figure 30. Typical Resistor String

RESISTOR STRING

The resistor string section is shown in Figure 30. It is simply a string of resistors, each of value R. The digital code loaded to the DAC register determines at which node on the string the voltage is tapped off to be fed into the output amplifier. The voltage is tapped off by closing one of the switches connecting the string to the amplifier. Because it is a string of resistors, it is specified monotonic. The DAC7552 architecture uses two separate resistor strings to minimize channel-to-channel crosstalk.

OUTPUT BUFFER AMPLIFIERS

The output amplifier is capable of generating rail-to-rail voltages on its output, which gives an output range of 0 V to V_{DD} . It is capable of driving a load of 2 k Ω in parallel with up to 1000 pF to GND. The source and sink capabilities of the output amplifier can be seen in the typical curves. The slew rate is 1.8 V/ μ s with a typical settling time of 3 μ s with the output unloaded.

DAC External Reference Input

Two separate reference pins are provided for two DACs, providing maximum flexibility. VREFA serves DAC A and VREFB serves DAC B. VREFA and VREFB can be externally shorted together for simplicity.

It is recommended to use a buffered reference in the external circuit (e.g., REF3140). The input impedance is typically 100 k Ω for each reference input pin.

Amplifier Sense Input

The DAC7552 contains two amplifier feedback input pins, VFBA and VFBB. For voltage output operation, VFBA and VFBB must externally connect to VOUTA and VOUTB, respectively. For better DC accuracy, these connections should be made at load points. The VFBA and VFBB pins are also useful for a variety of applications, including digitally controlled current sources. Each feedback input pin is internally connected to the DAC amplifier's negative input terminal through a 100-k Ω resistor; and, the amplifier's negative input terminal internally connects to ground through another 100-k Ω resistor (See Figure 29). This forms a gain-of-two, noninverting amplifier configuration. Overall gain remains one because the resistor string has a divide-by-two configuration. The resistance seen at each VFBx pin is approximately 200 k Ω to ground.

Power-On Reset

On power up, all internal registers are cleared and all channels are updated with zero-scale voltages. Until valid data is written, all DAC outputs remain in this state. This is particularly useful in applications where it is important to know the state of the DAC outputs while the device is powering up. In order not to turn on ESD protection devices, V_{DD} should be applied before any other pin is brought high.

Power Down

The DAC7552 has a flexible power-down capability as described in Table 2. Individual channels could be powered down separately or all channels could be powered down simultaneously. During a power-down condition, the user has flexibility to select the output impedance of each channel. During power-down operation, each channel can have either 1-k Ω , 100-k Ω , or Hi-Z output impedance to ground.

Asynchronous Clear

The DAC7552 output is asynchronously set to zero-scale voltage immediately after the CLR pin is brought low. The CLR signal resets all internal registers and therefore behaves like the Power-On Reset. The DAC7552 updates at the first rising edge of the SYNC signal that occurs after the CLR pin is brought back to high.

IOVDD and Level Shifters

The DAC7552 can be used with different logic families that require a wide range of supply voltages (from 1.8 V to 5.5 V). To enable this useful feature, the IOVDD pin must be connected to the logic supply voltage of the system. All DAC7552 digital input and output pins are equipped with level-shifter circuits. Level shifters at the input pins ensure that external logic high voltages are translated to the internal logic high voltage, with no additional power dissipation. Similarly, the level shifter for the SDO pin translates the internal logic high voltage (AVDD) to the external logic high level (IOVDD). For single-supply operation, the IOVDD pin can be tied to the AVDD pin.

SERIAL INTERFACE

The DAC7552 is controlled over a versatile 3-wire serial interface, which operates at clock rates up to 50 MHz and is compatible with SPI, QSPI, Microwire, and DSP interface standards.

In daisy-chain mode (DCEN = 1), the DAC7552 requires a falling SCLK edge after the rising SYNC, in order to initialize the serial interface for the next update.

16-Bit Word and Input Shift Register

The input shift register is 16 bits wide. DAC data is loaded into the device as a 16-bit word under the control of a serial clock input, SCLK, as shown in the [Figure 1](#) timing diagram. The 16-bit word, illustrated in [Table 1](#), consists of four control bits followed by 12 bits of DAC data. The data format is straight binary with all zeroes corresponding to 0-V output and all ones corresponding to full-scale output ($V_{REF} - 1$ LSB). Data is loaded MSB first (bit 15) where the first two bits (DB15 and DB14) determine if the input register, DAC register, or both are updated with shift register input data. Bit 13 (DB13) determines whether the data is for DAC A, DAC B, or both DACs. Bit 12 (DB12) determines either normal mode or power-down mode (see [Table 2](#)). All channels are updated when bits 15 and 14 (DB15 and DB14) are high.

The SYNC input is a level-triggered input that acts as a frame synchronization signal and chip enable. Data can only be transferred into the device while SYNC is low. To start the serial data transfer, SYNC should be taken low, observing the minimum SYNC to SCLK falling edge setup time, t_4 . After SYNC goes low, serial data is shifted into the device's input shift register on the falling edges of SCLK for 16 clock pulses.

The state of the daisy chain enable pin, DCEN, determines when the input data word is latched into the converter and when the output can be updated. When DCEN is low, daisy chain mode is disabled and the SDO pin is brought to a Hi-Z state. The first 16 data bits that follow the first falling edge of SYNC are stored in the shift register. Immediately following the 16th falling edge of SCLK, the converter latches the data word into the DAC and it updates immediately. If SYNC is brought high before the 16th data bit, the data word is ignored and no action occurs.

When DCEN is high, daisy chain mode is enabled causing data that is input to the shift register to be passed through and shifted out. The SDO pin becomes active and outputs the SDIN data with a 16 clock cycle delay. In this case, a rising edge of SYNC is required in order to load the shift register data into the DAC. The loaded data consists of the last 16 data bits received into the shift register before the rising edge of SYNC.

If daisy-chain operation is not needed, DCEN should permanently be tied to a logic low voltage.

Daisy-Chain Operation

When DCEN pin is brought high, daisy chaining is enabled. Serial Data Output (SDO) pin is provided to daisy-chain multiple DAC7552 devices in a system.

As long as SYNC is high or DCEN is low, the SDO pin is in a high-impedance state. When SYNC is brought low the output of the internal shift register is tied to the SDO pin. As long as SYNC is low and DCEN is high, SDO duplicates SDIN signal with a 16-cycle delay. To support multiple devices in a daisy chain, SCLK and SYNC signals are shared across all devices, and SDO of one DAC7552 should be tied to the SDIN of the next DAC7552. For n devices in such a daisy chain, $16n$ SCLK cycles are required to shift the entire input data stream. After $16n$ SCLK falling edges are received, following a falling SYNC, the data stream becomes complete and SYNC can be brought high to update n devices simultaneously. SDO operation is specified at a maximum SCLK speed of 10 MHz.

INTEGRAL AND DIFFERENTIAL LINEARITY

The DAC7552 uses precision thin-film resistors providing exceptional linearity and monotonicity. Integral linearity error is typically within (+/-) 0.35 LSBs, and differential linearity error is typically within (+/-) 0.08 LSBs.

GLITCH ENERGY

The DAC7552 uses a proprietary architecture that minimizes glitch energy. The code-to-code glitches are so low, they are usually buried within the wide-band noise and cannot be easily detected. The DAC7552 glitch is typically well under 0.1 nV-s. Such low glitch energy provides more than 10X improvement over industry alternatives.

CHANNEL-TO-CHANNEL CROSSTALK

The DAC7552 architecture is designed to minimize channel-to-channel crosstalk. The voltage change in one channel does not affect the voltage output in another channel. The DC crosstalk is in the order of a few microvolts. AC crosstalk is also less than -100 dBs. This provides orders of magnitude improvement over certain competing architectures.

APPLICATION INFORMATION

DAC SPI Interfacing

Care must be taken with the digital control signals that are applied directly to the DAC, especially with the SYNC pin. The SYNC pin must not be toggled without having a full SCLK pulse in between. If this condition is violated, the SPI interface locks up in an erroneous state, causing the DAC to behave incorrectly and possibly have errors. The DAC can be recovered from this faulty state by writing a valid SPI command or using the SYNC pin correctly; communication is then restored. Avoid glitches and transients on the SYNC line to ensure proper operation.

Waveform Generation

Due to its exceptional linearity, low glitch, and low crosstalk, the DAC7552 is well suited for waveform generation (from DC to 10 kHz). The DAC7552 large-signal settling time is 5 μ s, supporting an update rate of 200 KSPS. However, the update rates can exceed 1 MSPS if the waveform to be generated consists of small voltage steps between consecutive DAC updates. To obtain a high dynamic range, REF3140 (4.096 V) or REF02 (5 V) are recommended for reference voltage generation.

Generating ± 5 -V, ± 10 -V, and ± 12 -V Outputs For Precision Industrial Control

Industrial control applications can require multiple feedback loops consisting of sensors, ADCs, MCUs, DACs, and actuators. Loop accuracy and loop speed are the two important parameters of such control loops.

Loop Accuracy:

In a control loop, the ADC has to be accurate. Offset, gain, and the integral linearity errors of the DAC are not factors in determining the accuracy of the loop. As long as a voltage exists in the transfer curve of a monotonic DAC, the loop can find it and settle to it. On the other hand, DAC resolution and differential linearity do determine the loop accuracy, because each DAC step determines the minimum incremental change the loop can generate. A DNL error less than -1 LSB (non-monotonicity) can create loop instability. A DNL error greater than +1 LSB implies unnecessarily large voltage steps and missed voltage targets. With high DNL errors, the loop loses its stability, resolution, and accuracy. Offering 12-bit ensured monotonicity and ± 0.08 LSB typical DNL error, 755X DACs are great choices for precision control loops.

Loop Speed:

Many factors determine control loop speed. Typically, the ADC's conversion time and the MCU's computation time are the two major factors that dominate the time constant of the loop. DAC settling time is rarely a dominant factor because ADC conversion times usually exceed DAC conversion times. DAC offset, gain, and linearity errors can slow the loop down only during the start-up. Once the loop reaches its steady-state operation, these errors do not affect loop speed any further. Depending on the ringing characteristics of the loop's transfer function, DAC glitches can also slow the loop down. With its 1 MSPS (small-signal) maximum data update rate, DAC7552 can support high-speed control loops. Ultralow glitch energy of the DAC7552 significantly improves loop stability and loop settling time.

Generating Industrial Voltage Ranges:

For control loop applications, DAC gain and offset errors are not important parameters. This could be exploited to lower trim and calibration costs in a high-voltage control circuit design. Using an operational amplifier (OPA130), and a voltage reference (REF3140), the DAC7552 can generate the wide voltage swings required by the control loop.

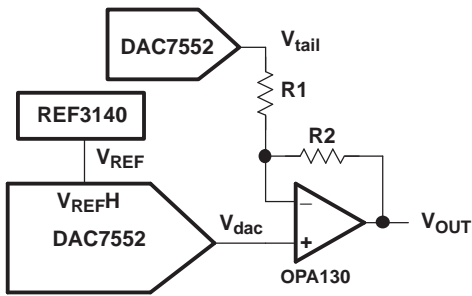

Figure 31. Low-cost, Wide-swing Voltage Generator for Control Loop Applications

The output voltage of the configuration is given by:

$$V_{out} = V_{REF} \left(\frac{R2}{R1} + 1 \right) \frac{D_{in}}{4096} - V_{tail} \frac{R2}{R1} \quad (1)$$

Fixed R1 and R2 resistors can be used to coarsely set the gain required in the first term of the equation. Once R2 and R1 set the gain to include some minimal over-range, a DAC7552 channel could be used to set the required offset voltage. Residual errors are not an issue for loop accuracy because offset and gain errors could be tolerated. One DAC7552 channel can provide the Vtail voltage, while the other DAC7552 channel can provide Vdac voltage to help generate the high-voltage outputs.

For ±5-V operation: R1=10 kΩ, R2 = 15 kΩ, Vtail = 3.33 V, VREF= 4.096 V

For ±10-V operation: R1=10 kΩ, R2 = 39 kΩ, Vtail = 2.56 V, VREF = 4.096 V

For ±12-V operation: R1=10 kΩ, R2 = 49 kΩ, Vtail = 2.45 V, VREF = 4.096 V

REVISION HISTORY

Changes from Revision C (December 2005) to Revision D	Page
• Changed to Revision D, June 2011	1
• Changed row 4, DAC(s) column from A to A-B, row 5, from A to B and row 6, from B to A-B	13
• Changed wording in 3rd and 4th paragraphs in "16-Bit Word and Input Shift Register" section	15
• Added new sub section "DAC SPI Interfacing" and 1 paragraph directly under APPLICATION INFORMATION	16

PACKAGING INFORMATION

Orderable Device	Status (1)	Package Type	Package Drawing	Pins	Package Qty	Eco Plan (2)	Lead/Ball Finish (6)	MSL Peak Temp (3)	Op Temp (°C)	Device Marking (4/5)	Samples
DAC7552IRGTR	ACTIVE	VQFN	RGT	16	3000	Green (RoHS & no Sb/Br)	CU NIPDAU	Level-3-260C-168 HR	-40 to 105	D752	Samples
DAC7552IRGTRG4	ACTIVE	VQFN	RGT	16	3000	Green (RoHS & no Sb/Br)	CU NIPDAU	Level-3-260C-168 HR	-40 to 105	D752	Samples
DAC7552IRGTT	ACTIVE	VQFN	RGT	16	250	Green (RoHS & no Sb/Br)	CU NIPDAU	Level-3-260C-168 HR	-40 to 105	D752	Samples
DAC7552IRGTTG4	ACTIVE	VQFN	RGT	16	250	Green (RoHS & no Sb/Br)	CU NIPDAU	Level-3-260C-168 HR	-40 to 105	D752	Samples

(1) The marketing status values are defined as follows:

ACTIVE: Product device recommended for new designs.

LIFEBUY: TI has announced that the device will be discontinued, and a lifetime-buy period is in effect.

NRND: Not recommended for new designs. Device is in production to support existing customers, but TI does not recommend using this part in a new design.

PREVIEW: Device has been announced but is not in production. Samples may or may not be available.

OBSOLETE: TI has discontinued the production of the device.

(2) **RoHS:** TI defines "RoHS" to mean semiconductor products that are compliant with the current EU RoHS requirements for all 10 RoHS substances, including the requirement that RoHS substance do not exceed 0.1% by weight in homogeneous materials. Where designed to be soldered at high temperatures, "RoHS" products are suitable for use in specified lead-free processes. TI may reference these types of products as "Pb-Free".

RoHS Exempt: TI defines "RoHS Exempt" to mean products that contain lead but are compliant with EU RoHS pursuant to a specific EU RoHS exemption.

Green: TI defines "Green" to mean the content of Chlorine (Cl) and Bromine (Br) based flame retardants meet JS709B low halogen requirements of <=1000ppm threshold. Antimony trioxide based flame retardants must also meet the <=1000ppm threshold requirement.

(3) MSL, Peak Temp. - The Moisture Sensitivity Level rating according to the JEDEC industry standard classifications, and peak solder temperature.

(4) There may be additional marking, which relates to the logo, the lot trace code information, or the environmental category on the device.

(5) Multiple Device Markings will be inside parentheses. Only one Device Marking contained in parentheses and separated by a "-" will appear on a device. If a line is indented then it is a continuation of the previous line and the two combined represent the entire Device Marking for that device.

(6) Lead/Ball Finish - Orderable Devices may have multiple material finish options. Finish options are separated by a vertical ruled line. Lead/Ball Finish values may wrap to two lines if the finish value exceeds the maximum column width.

Important Information and Disclaimer: The information provided on this page represents TI's knowledge and belief as of the date that it is provided. TI bases its knowledge and belief on information provided by third parties, and makes no representation or warranty as to the accuracy of such information. Efforts are underway to better integrate information from third parties. TI has taken and

continues to take reasonable steps to provide representative and accurate information but may not have conducted destructive testing or chemical analysis on incoming materials and chemicals. TI and TI suppliers consider certain information to be proprietary, and thus CAS numbers and other limited information may not be available for release.

In no event shall TI's liability arising out of such information exceed the total purchase price of the TI part(s) at issue in this document sold by TI to Customer on an annual basis.

TAPE AND REEL INFORMATION

QUADRANT ASSIGNMENTS FOR PIN 1 ORIENTATION IN TAPE

*All dimensions are nominal

Device	Package Type	Package Drawing	Pins	SPQ	Reel Diameter (mm)	Reel Width W1 (mm)	A0 (mm)	B0 (mm)	K0 (mm)	P1 (mm)	W (mm)	Pin1 Quadrant
DAC7552IRGTR	VQFN	RGT	16	3000	330.0	12.4	3.3	3.3	1.1	8.0	12.0	Q2
DAC7552IRGTT	VQFN	RGT	16	250	180.0	12.4	3.3	3.3	1.1	8.0	12.0	Q2

TAPE AND REEL BOX DIMENSIONS

*All dimensions are nominal

Device	Package Type	Package Drawing	Pins	SPQ	Length (mm)	Width (mm)	Height (mm)
DAC7552IRGTR	VQFN	RGT	16	3000	350.0	350.0	43.0
DAC7552IRGTT	VQFN	RGT	16	250	210.0	185.0	35.0

RGT 16

GENERIC PACKAGE VIEW

VQFN - 1 mm max height

PLASTIC QUAD FLATPACK - NO LEAD

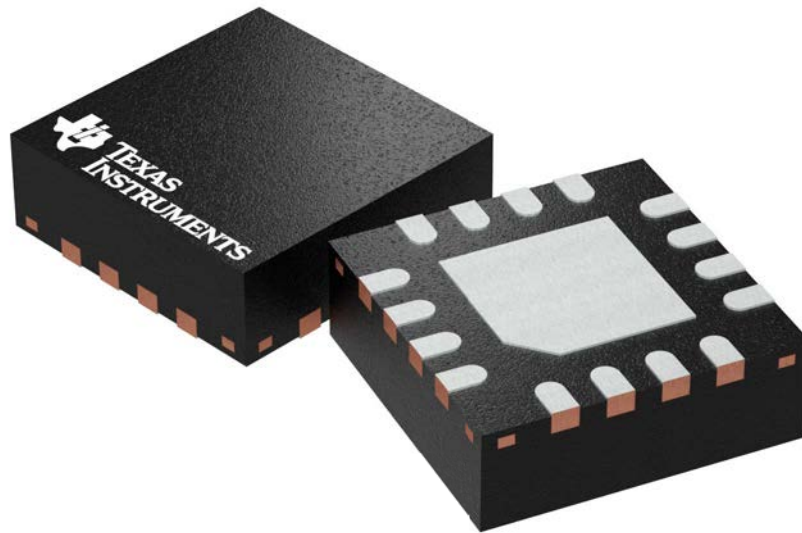

Images above are just a representation of the package family, actual package may vary.
Refer to the product data sheet for package details.

4203495/1

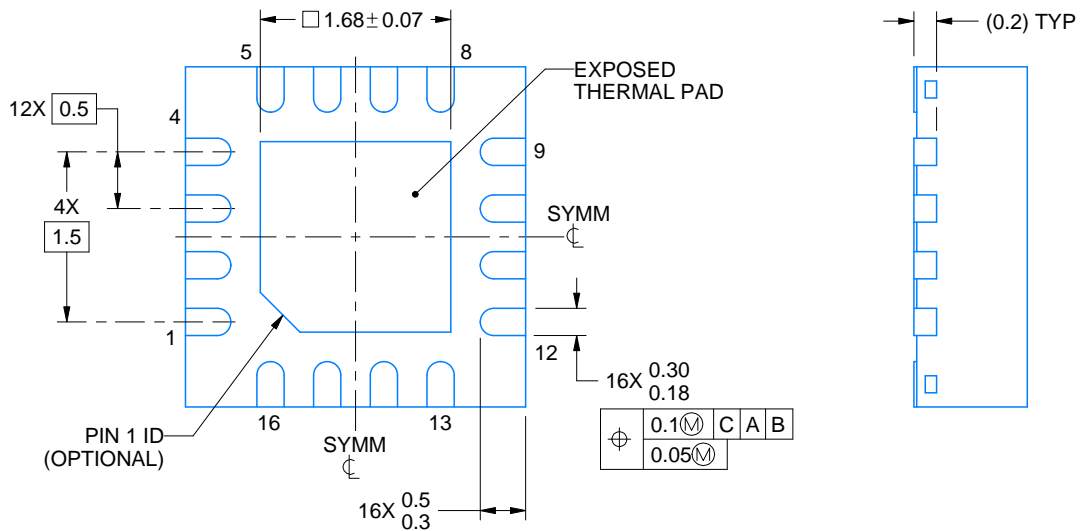
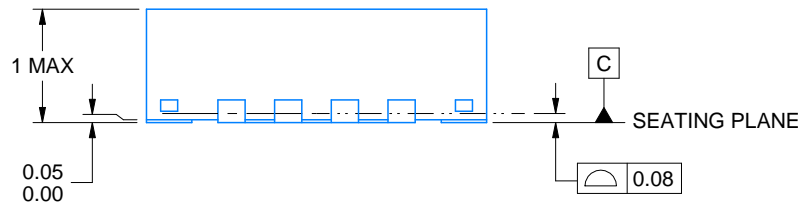
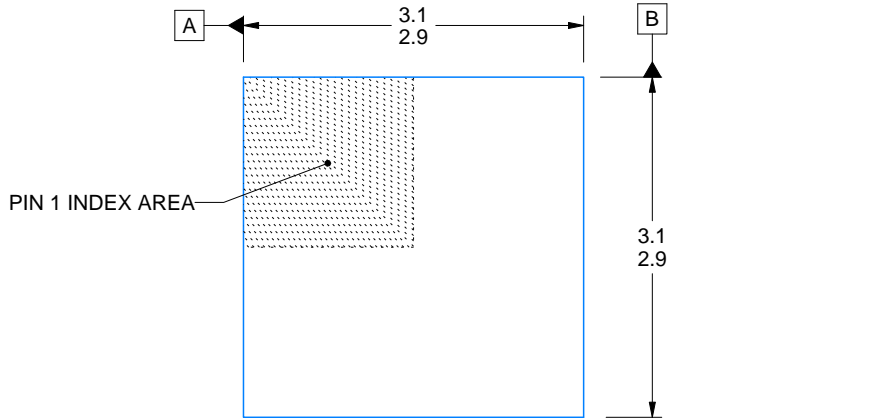
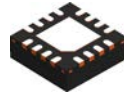

4222419/B 11/2016

NOTES:

1. All linear dimensions are in millimeters. Any dimensions in parenthesis are for reference only. Dimensioning and tolerancing per ASME Y14.5M.
2. This drawing is subject to change without notice.
3. The package thermal pad must be soldered to the printed circuit board for thermal and mechanical performance.

EXAMPLE STENCIL DESIGN

RGT0016C

VQFN - 1 mm max height

PLASTIC QUAD FLATPACK - NO LEAD

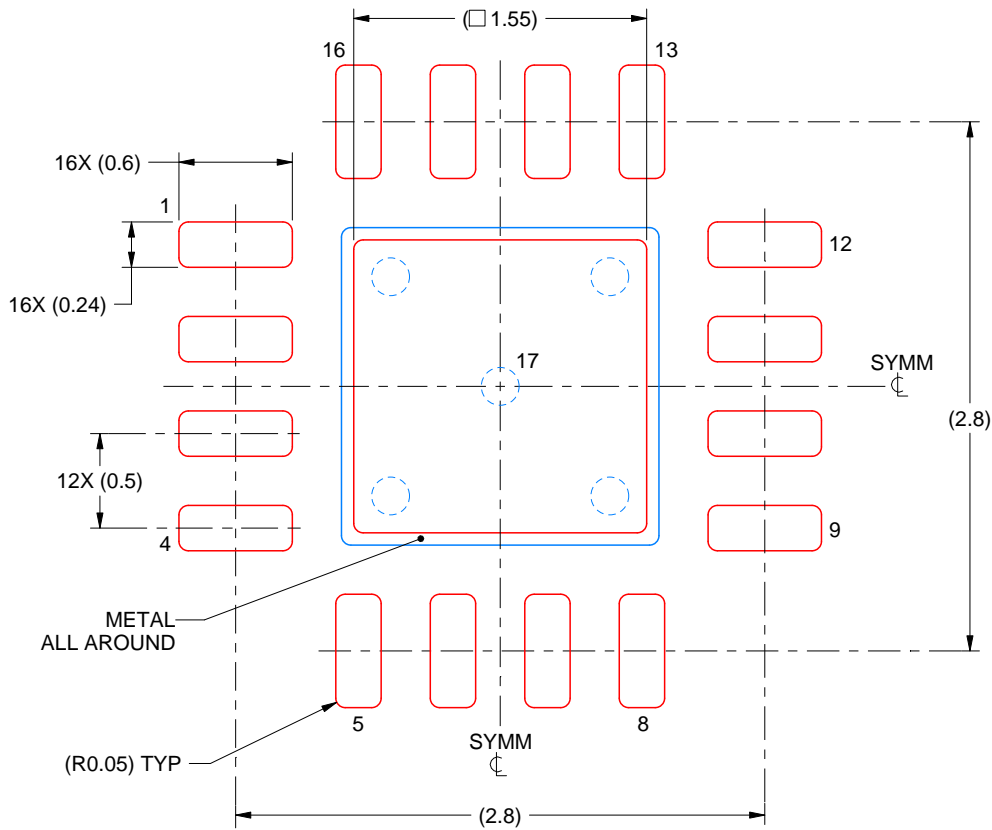

SOLDER PASTE EXAMPLE
BASED ON 0.125 mm THICK STENCIL

EXPOSED PAD 17:
85% PRINTED SOLDER COVERAGE BY AREA UNDER PACKAGE
SCALE:25X

4222419/B 11/2016

NOTES: (continued)

6. Laser cutting apertures with trapezoidal walls and rounded corners may offer better paste release. IPC-7525 may have alternate design recommendations.

IMPORTANT NOTICE AND DISCLAIMER

TI PROVIDES TECHNICAL AND RELIABILITY DATA (INCLUDING DATASHEETS), DESIGN RESOURCES (INCLUDING REFERENCE DESIGNS), APPLICATION OR OTHER DESIGN ADVICE, WEB TOOLS, SAFETY INFORMATION, AND OTHER RESOURCES "AS IS" AND WITH ALL FAULTS, AND DISCLAIMS ALL WARRANTIES, EXPRESS AND IMPLIED, INCLUDING WITHOUT LIMITATION ANY IMPLIED WARRANTIES OF MERCHANTABILITY, FITNESS FOR A PARTICULAR PURPOSE OR NON-INFRINGEMENT OF THIRD PARTY INTELLECTUAL PROPERTY RIGHTS.

These resources are intended for skilled developers designing with TI products. You are solely responsible for (1) selecting the appropriate TI products for your application, (2) designing, validating and testing your application, and (3) ensuring your application meets applicable standards, and any other safety, security, or other requirements. These resources are subject to change without notice. TI grants you permission to use these resources only for development of an application that uses the TI products described in the resource. Other reproduction and display of these resources is prohibited. No license is granted to any other TI intellectual property right or to any third party intellectual property right. TI disclaims responsibility for, and you will fully indemnify TI and its representatives against, any claims, damages, costs, losses, and liabilities arising out of your use of these resources.

TI's products are provided subject to TI's Terms of Sale (www.ti.com/legal/termsofsale.html) or other applicable terms available either on ti.com or provided in conjunction with such TI products. TI's provision of these resources does not expand or otherwise alter TI's applicable warranties or warranty disclaimers for TI products.

Mailing Address: Texas Instruments, Post Office Box 655303, Dallas, Texas 75265
Copyright © 2019, Texas Instruments Incorporated

Looking for pricing, stock, or lifecycle information?

Click below to explore more details on WIN SOURCE:

 [View DAC7552IRGTT on WIN SOURCE](#)

 [Texas Instruments](#) Information

Optimize Your Supply Chain with WIN SOURCE Solutions

-  Global Sourcing Solution
-  Obsolete Management
-  Cost Control Management
-  Shortage Management
-  Alternative Solution
-  Excess Inventory Management