



**THE DATASHEET OF
MSA-0336-TR1G**



MSA-0336

Cascadable Silicon Bipolar MMIC Amplifier



Data Sheet

Description

The MSA-0336 is a high performance silicon bipolar Monolithic Microwave Integrated Circuit (MMIC) housed in a cost effective, microstrip package. This MMIC is designed for use as a general purpose 50 Ω gain block. Typical applications include narrow and broad band IF and RF amplifiers in industrial and military applications.

The MSA-series is fabricated using Avago's 10 GHz f_T , 25 GHz f_{MAX} , silicon bipolar MMIC process which uses nitride self-alignment, ion implantation, and gold metallization to achieve excellent performance, uniformity and reliability. The use of an external bias resistor for temperature and current stability also allows bias flexibility.

Features

- Cascadable 50 Ω Gain Block
- 3 dB Bandwidth: DC to 2.7 GHz
- 12.0 dB Typical Gain at 1.0 GHz
- 10.0 dBm Typical P_{1dB} at 1.0 GHz
- Unconditionally Stable ($k > 1$)
- Cost Effective Ceramic Microstrip Package

36 micro-X Package

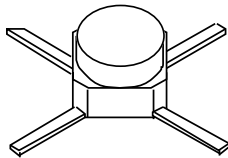

Typical Biasing Configuration

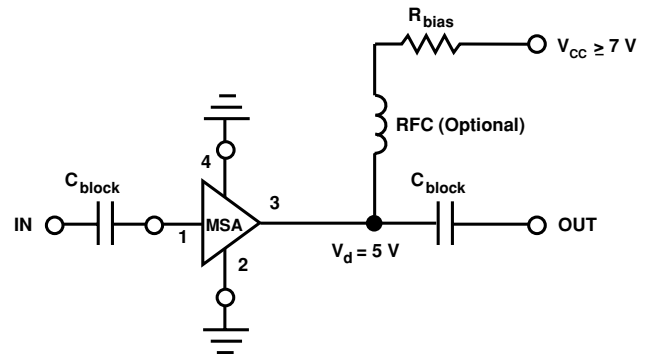

MSA-0336 Absolute Maximum Ratings

Parameter	Absolute Maximum ^[1]
Device Current	80 mA
Power Dissipation ^[2,3]	425 mW
RF Input Power	+13 dBm
Junction Temperature	150°C
Storage Temperature ^[4]	-65 to 150°C

Thermal Resistance^{[2,5]:}

$$\theta_{jc} = 150^{\circ}\text{C}/\text{W}$$

Notes:

1. Permanent damage may occur if any of these limits are exceeded.
2. $T_{\text{CASE}} = 25^{\circ}\text{C}$.
3. Derate at 6.7 mW/°C for $T_{\text{C}} > 136^{\circ}\text{C}$.
4. Storage above +150°C may tarnish the leads of this package making it difficult to solder into a circuit.
5. The small spot size of this technique results in a higher, though more accurate determination of θ_{jc} than do alternate methods.

Electrical Specifications^[1], $T_{\text{A}} = 25^{\circ}\text{C}$

Symbol	Parameters and Test Conditions: $I_{\text{d}} = 35 \text{ mA}$, $Z_{\text{o}} = 50 \Omega$	Units	Min.	Typ.	Max.
G_{P}	Power Gain ($ S_{21} ^2$) $f = 0.1 \text{ GHz}$	dB	11.5	12.5	13.5
ΔG_{P}	Gain Flatness $f = 0.1 \text{ to } 1.6 \text{ GHz}$	dB		± 0.6	± 1.0
$f_{3 \text{ dB}}$	3 dB Bandwidth	GHz		2.7	
VSWR	Input VSWR $f = 0.1 \text{ to } 3.0 \text{ GHz}$			1.6:1	
	Output VSWR $f = 0.1 \text{ to } 3.0 \text{ GHz}$			1.7:1	
NF	50 Ω Noise Figure $f = 1.0 \text{ GHz}$	dB		6.0	
$P_{1 \text{ dB}}$	Output Power at 1 dB Gain Compression $f = 1.0 \text{ GHz}$	dBm		10.0	
IP_3	Third Order Intercept Point $f = 1.0 \text{ GHz}$	dBm		23.0	
t_{D}	Group Delay $f = 1.0 \text{ GHz}$	psec		125	
V_{d}	Device Voltage	V	4.5	5.0	5.5
dV/dT	Device Voltage Temperature Coefficient	mV/°C		-8.0	

Notes:

1. The recommended operating current range for this device is 20 to 50 mA. Typical performance as a function of current is on the following page.

Ordering Information

Part Numbers	No. of Devices	Comments
MSA-0336-BLKG	100	Bulk
MSA-0336-TR1G	1000	7" Reel

MSA-0336 Typical Scattering Parameters ($Z_0 = 50 \Omega$, $T_A = 25^\circ\text{C}$, $I_d = 35 \text{ mA}$)

Freq. GHz	S ₁₁		S ₂₁			S ₁₂			S ₂₂	
	Mag	Ang	dB	Mag	Ang	dB	Mag	Ang	Mag	Ang
0.1	.05	177	12.6	4.25	175	-18.6	.118	1	.17	-8
0.2	.05	170	12.5	4.24	170	-18.3	.121	2	.17	-17
0.4	.04	161	12.5	4.20	160	-18.3	.122	3	.17	-33
0.6	.04	156	12.4	4.15	151	-18.3	.121	5	.18	-47
0.8	.03	149	12.2	4.09	142	-17.9	.128	8	.19	-61
1.0	.02	154	12.1	4.02	132	-17.6	.131	9	.20	-73
1.5	.03	-104	11.6	3.79	109	-16.8	.145	13	.20	-102
2.0	.08	-136	10.9	3.49	87	-15.7	.164	11	.21	-133
2.5	.14	-157	10.0	3.16	71	-14.9	.180	13	.23	-155
3.0	.21	-176	9.0	2.81	53	-14.6	.187	8	.24	-173
3.5	.27	170	7.9	2.49	36	-13.9	.202	4	.25	178
4.0	.31	157	6.9	2.20	20	-13.6	.209	-1	.24	177
5.0	.37	125	4.9	1.76	-10	-12.9	.226	-12	.20	165
6.0	.51	87	2.8	1.38	-38	-12.8	.230	-25	.22	130

Typical Performance, $T_A = 25^\circ\text{C}$

(unless otherwise noted)

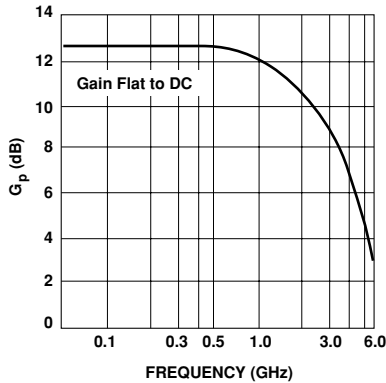

Figure 1. Typical Power Gain vs. Frequency, $T_A = 25^\circ\text{C}$, $I_d = 35 \text{ mA}$.

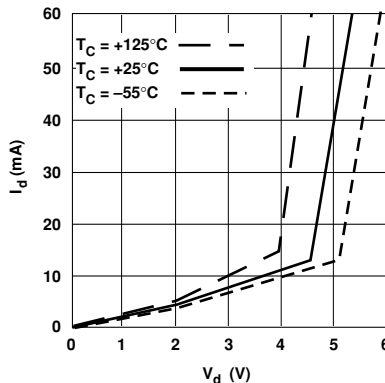

Figure 2. Device Current vs. Voltage.

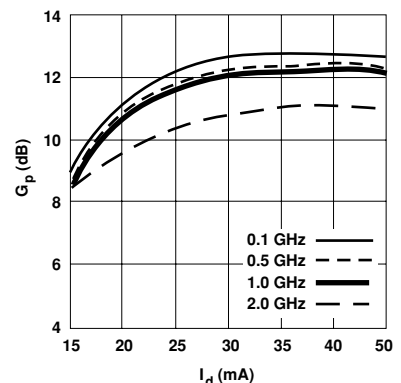

Figure 3. Power Gain vs. Current.

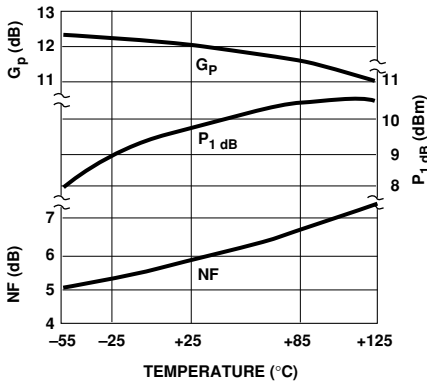

Figure 4. Output Power at 1 dB Gain Compression, NF and Power Gain vs. Mounting Surface Temperature, $f = 1.0 \text{ GHz}$, $I_d = 35 \text{ mA}$.

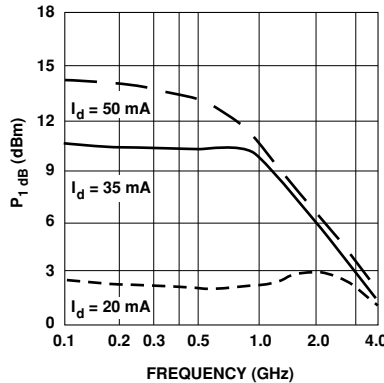

Figure 5. Output Power at 1 dB Gain Compression vs. Frequency.

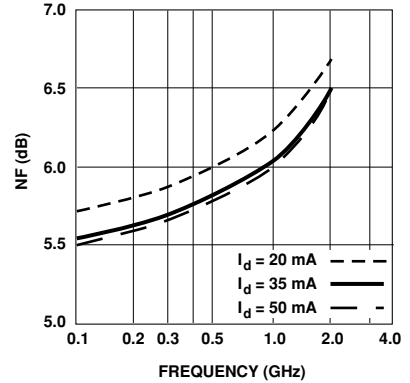
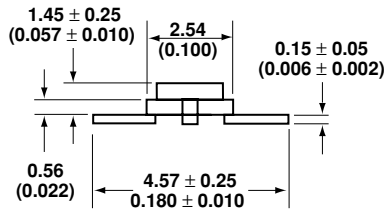
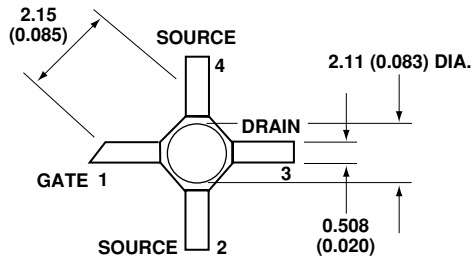

Figure 6. Noise Figure vs. Frequency.

36 micro-X Package Dimensions



Notes:

1. Dimensions are in millimeters (inches)
2. Tolerances: in .xxx = ± 0.005
mm .xx = ± 0.13



For product information and a complete list of distributors, please go to our web site: www.avagotech.com

Avago, Avago Technologies, and the A logo are trademarks of Avago Technologies, Limited in the United States and other countries. Data subject to change. Copyright © 2007 Avago Technologies, Limited. All rights reserved. Obsoletes 5989-2739EN AV02-0302EN - April 12, 2007



Looking for pricing, stock, or lifecycle information?

Click below to explore more details on WIN SOURCE:

-  [View MSA-0336-TR1G on WIN SOURCE](#)
-  [Broadcom Limited Information](#)

Optimize Your Supply Chain with WIN SOURCE Solutions

-  Global Sourcing Solution
-  Obsolete Management
-  Cost Control Management
-  Shortage Management
-  Alternative Solution
-  Excess Inventory Management