



**PC Card Current Limit Interface and Capacitor Charger**

**General Description**

The AAT4621 SmartSwitch family is a current limited P-channel MOSFET power switch designed for high-side load-switching applications in PC Card GSM/GPRS/3G modem cards. Used in conjunction with a super capacitor, the AAT4621 will ensure that the power ratings of the PCMCIA host are not exceeded at any time. Featuring two independent, programmable current limits and a power loop, the AAT4621 can ensure that the super capacitor can be charged without exceeding PCMCIA specifications. The current limit is set by two external resistors allowing a  $\pm 10\%$  current limit accuracy over the normal operating temperature range. The switch can be controlled from either of the two enable inputs and in the off condition will block currents in both directions. The AAT4621 also incorporates a System READY function which can advise the system that the super capacitor is fully charged and ready for use. Adjustable hysteresis is provided with the addition of an external resistor. The quiescent supply current is typically a low  $40\mu\text{A}$ . In shut-down mode, the supply current decreases to less than  $1\mu\text{A}$ . The AAT4621 has a current limit range from 75mA to 1200mA; the AAT4621-1 has a current limit range from 150mA to 2400mA.

The AAT4621 is available in a thermally enhanced, Pb-free 14-pin TDFN33 package and is specified over the  $-40^{\circ}\text{C}$  to  $85^{\circ}\text{C}$  temperature range.

**Features**

- Operating Voltage Range: 3.0V to 5.5V
- Dual Independent Current Limits
  - AAT4621: 75mA to 1200mA
  - AAT4621-1: 150mA to 2400mA
  - $\pm 10\%$  Current Accuracy
- Reverse Current Blocking Protection
- Power Loop
- Low Quiescent Current
  - $40\mu\text{A}$  Typical
  - $1.0\mu\text{A}$  Max with Switch Off
- $65\text{m}\Omega$  Typical  $R_{\text{DS(ON)}}$  at 3V
- System READY Output with Externally Programmable Hysteresis
- Only 1.4V Needed for Enable Control Pin
- Under-Voltage Lockout
- Over-Temperature Protection
- Temperature Range:  $-40$  to  $85^{\circ}\text{C}$
- 14-Pin TDFN33 Package

**Applications**

- Capacitor Charger
- CF Card Port Power Protection
- Express Card GSM/GPRS/3G Modems
- PC Card GSM/GPRS Class 10/12 Modems
- WiMAX Cards

**Typical Application**

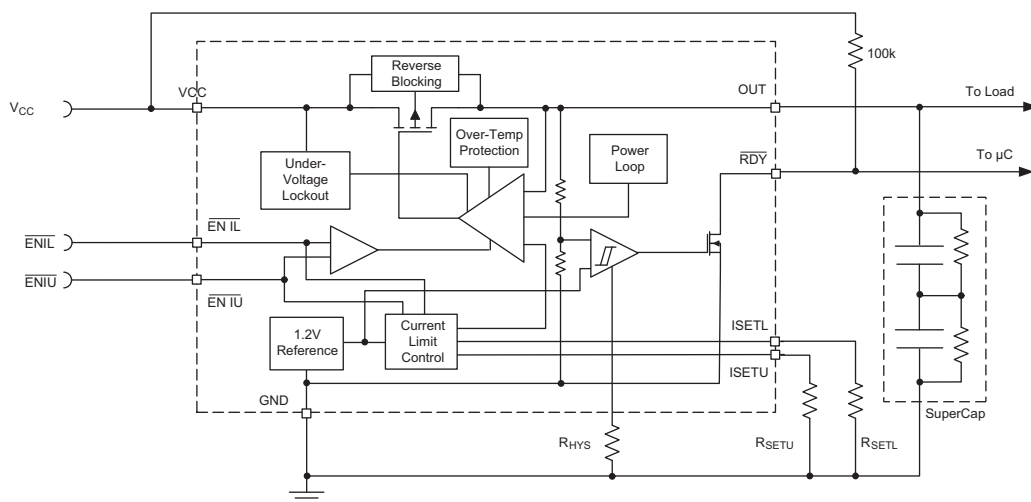

**PC Card Current Limit Interface and Capacitor Charger**

**Pin Descriptions**

Pin #	Symbol	Function
1	$\overline{\text{RDY}}$	System ready pin. Open drain, active low, initiated when the capacitor is 98% charged.
2	RHYS	System READY hysteresis. Connect a resistor to ground to set the System Ready comparator hysteresis.
3	ISETU	Upper current limit set input. A resistor from $I_{\text{SETL}}$ to ground sets the maximum upper current limit for the switch. The AAT4621 has a current limit range from 75mA to 1200mA; the AAT4621-1 has a current limit range from 150mA to 2400mA. Connect to ground to disable current limit.
4	ISETL	Lower current-limit set input. A resistor from $I_{\text{SETU}}$ to ground sets the maximum lower current limit for the switch. The AAT4621 has a current limit range from 75mA to 1200mA; the AAT4621-1 has a current limit range from 150mA to 2400mA. Connect to ground to disable current limit.
5, 6, 7	OUT	P-channel MOSFET drain connection. Connect to super capacitor from OUT to GND.
8, 9, 10, 11	VCC	Input pins to the P-channel MOSFET source. Connect 1 $\mu$ F capacitor from VCC to GND.
12	GND	Device ground connection.
13	$\overline{\text{EN IL}}$	Enable input. Active low enable with internal pull up. Also switches in the lower current limit initiating the super capacitor to start charging.
14	$\overline{\text{EN IU}}$	Enable input. Active low enable with internal pull up. Also switches in the higher current limit to allow the System to start functioning. Can be directly connected to System Ready for automatic enabling. When both $\overline{\text{EN IL B}}$ and $\overline{\text{EN IU B}}$ are enabled, $I_{\text{SETU}}$ will be selected.
EP	EP	The exposed thermal pad (EP) must be connected to the board ground plane and Pin 12. The ground plane should include a large exposed copper pad under the package for thermal dissipation (see package outline).

**Pin Configuration**

**TDFN33-14  
(Top View)**

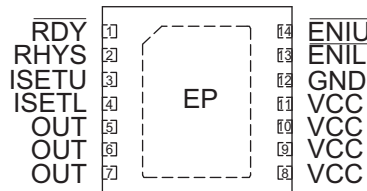

**PC Card Current Limit Interface and Capacitor Charger**

**Absolute Maximum Ratings<sup>1</sup>**

Symbol	Description	Value	Units
V <sub>CC</sub>	V <sub>CC</sub> to GND	-0.3 to 6.0	V
V <sub>EN</sub>	ENIL, ENIU to GND	-0.3 to V <sub>CC</sub> + 0.3	V
V <sub>SETI</sub> , V <sub>OUT</sub>	ISETL, ISETU, OUT to GND	-0.3 to V <sub>CC</sub> + 0.3	V
I <sub>MAX</sub>	Maximum Continuous Switch Current	2.5	A
T <sub>J</sub>	Maximum Junction Operating Temperature Range	-40 to +150	°C
T <sub>LEAD</sub>	Maximum Soldering Temperature (at leads, 10 sec.)	300	°C
T <sub>STG</sub>	Storage Temperature Range	-65 to 150	°C

**Thermal Characteristics**

Symbol	Description	Value	Units
θ <sub>JA</sub>	Maximum Thermal Resistance <sup>2</sup>	50	°C/W
P <sub>D</sub>	Maximum Power Dissipation <sup>2</sup>	2	W

1. Stresses above those listed in Absolute Maximum Ratings may cause permanent damage to the device. Functional operation at conditions other than the operating conditions specified is not implied. Only one Absolute Maximum Rating should be applied at any one time.  
2. Mounted on an FR4 board.

**PC Card Current Limit Interface and Capacitor Charger**

**Electrical Characteristics<sup>1</sup>**

$V_{CC} = 3.0V$  to  $5.5V$ ,  $T_A = -40^{\circ}C$  to  $85^{\circ}C$  unless otherwise noted. Typical values are at  $T_A = 25^{\circ}C$ .

Symbol	Description	Conditions	Min	Typ	Max	Units
<b>AAT4621</b>						
$V_{CC}$	Operation Voltage		3.0		5.5	V
$I_Q$	Quiescent Current	$\overline{EN IL}$ or $\overline{EN IU} = V_{CC}$ , $I_{OUT} = 0$ , $R_{HYS} = 200k\Omega$		40	75	$\mu A$
$I_{QU0}$	Quiescent Current $I_{Q0}$	$\overline{EN IL} = V_{CC}$ , $\overline{EN IU} = GND$ , $I_{OUT} = 0$ , $I_{SET} = GND$ , $R_{HYS} = 200k\Omega$		40	75	$\mu A$
$I_{Q(OFF)}$	Off Supply Current	$\overline{EN IL} = \overline{EN IU} = V_{CC}$		0.4	1.0	$\mu A$
$I_{SD(OFF)}$	Off Switch Current	$\overline{EN IL} = \overline{EN IU} = V_{CC}$ , $V_{SUPERCAP} = 0$		0.4	10	$\mu A$
$V_{UVLO}$	Under-Voltage Lockout	Rising edge, 1% hysteresis		2.7	3.0	V
$R_{DS(ON)}$	On-Resistance	$V_{CC} = 4.75V$ , $R_{SETL} = R_{SETU} = 0k$		50	100	$m\Omega$
		$V_{CC} = 3.0V$ , $R_{SETL} = R_{SETU} = 0k$		65	120	
$I_{LIMACC}$	Lower Current Limit Accuracy	$R_{SETL} = 249k\Omega$ ; $\Delta T_A \leq 25^{\circ}C$	180	200	220	mA
		$R_{SETL} = 249k\Omega$	170	200	230	
$I_{LIMACC}$	Upper Current Limit Accuracy	$R_{SETU} = 1.24M\Omega$ ; $\Delta T_A \leq 25^{\circ}C$	900	1000	1100	mA
		$R_{SETU} = 1.24M\Omega$	850	1000	1150	
$I_{LIM(MIN)}$	Minimum Current Limit			75		mA
$V_{EN(L)}$	EN Input Low Voltage	$V_{CC} = 3.0V$ to $5.5V^2$			0.4	V
$V_{EN(H)}$	EN Input High Voltage	$V_{CC} = 3.0V$ to $5.5V^2$	1.4			V
$I_{EN(SINK)}$	EN Input Leakage	$V_{EN} = 5.5V$			1.0	$\mu A$
$T_{DEL(OFF)}$	Turn-Off Delay Time	$V_{CC} = 5V$		0.4	1.0	$\mu s$
$V_{RDY}$	System READY Trip Threshold	$V_{OUT}$ rising, $T_A = 25^{\circ}C$		98		% of $V_{OUT}$
$V_{RDYHYS}$	System READY Hysteresis	$R_{HYS} = 200k\Omega$		200		mV
$V_{RDY(L)}$	System READY Voltage Low	$I_{SINK} = 1mA$			0.4	V
$I_{RDY}$	RDY Leakage Current	$V_{RDY} < 5.5V$ , $V_{OUT} < 98\%$ of $V_{OUT}$			1.0	$\mu A$
OTMP	Shutdown Temperature			145		$^{\circ}C$

1. The AAT4621 is guaranteed to meet performance specification over the  $-40^{\circ}C$  to  $85^{\circ}C$  operating temperature range and is assured by design, characterization and correlation with statistical process controls.  
2. For  $V_{CC}$  outside this range consult the Typical EN Threshold curve.

# DATA SHEET

# AAT4621

## PC Card Current Limit Interface and Capacitor Charger

### Electrical Characteristics<sup>1</sup>

$V_{CC} = 3.0V$  to  $5.5V$ ,  $T_A = -40^{\circ}C$  to  $85^{\circ}C$  unless otherwise noted. Typical values are at  $T_A = 25^{\circ}C$ .

Symbol	Description	Conditions	Min	Typ	Max	Units
<b>AAT4621-1</b>						
$V_{CC}$	Operation Voltage		3		5.5	V
$I_Q$	Quiescent Current	$\overline{ENIL}$ or $\overline{ENIU} = 0V$ , $I_{OUT} = 0$ ; $R_{HYS} = 200k\Omega$		40	75	$\mu A$
$I_{Q(OFF)}$	Off Supply Current	$\overline{ENIL} = \overline{ENIU} = \text{High}$ , $V_{OUT} = \text{Open}$		0.4	1	$\mu A$
$I_{SD(OFF)}$	Off Switch Current	$\overline{ENIL} = \overline{ENIU} = \text{High}$ , $V_{OUT} = 0V$		0.4	10	$\mu A$
$V_{UVLO}$	Under-Voltage Lockout	Rising Edge		2.7	3	V
	Hysteresis			120		mV
$R_{DS(ON)}$	On-Resistance	$V_{CC} = 4.75V$ , $R_{SETU} = R_{SETL} = 0K$		50	100	m $\Omega$
		$V_{CC} = 3.0V$ , $R_{SETU} = R_{SETL} = 0K$		65	120	
$I_{LIMACC}$	Lower Current Limit Accuracy	$R_{SETL} = 249K\Omega$ ; $\Delta T_A \leq 25^{\circ}C$	360	400	440	mA
		$R_{SETL} = 249K\Omega$	340	400	460	
$I_{LIMACC}$	Upper Current Limit Accuracy	$R_{SETU} = 1.24M\Omega$ ; $\Delta T_A \leq 20^{\circ}C$ ,	1800	2000	2200	mA
		$R_{SETU} = 1.24M\Omega$ ,	1700	2000	2300	
$I_{LIM(MIN)}$	Minimum Current Limit			150		mA
$V_{EN(L)}$	EN Input Low Voltage, VENLU	$V_{CC} = 3.0$ to $5.5V$			0.4	V
	EN Input Low Voltage, VENLL	$V_{CC} = 3.0$ to $5.5V$			0.4	V
$V_{EN(H)}$	EN Input High Voltage, VENHU	$V_{CC} = 3.0$ to $5.5V$	1.4			V
	EN Input High Voltage, VENHL	$V_{CC} = 3.0$ to $5.5V$	1.4			V
$I_{EN(SINK)}$	EN Input Leakage	$V_{EN} = 5.5V$			1	$\mu A$
$T_{DEL(OFF)}$	Turn-Off Delay Time	$V_{CC} = 5.0V$		0.4	1	$\mu s$
$V_{RDY}$	System Ready Trip Threshold	$V_{OUT}$ Rising, $T_A = 25^{\circ}C$ ( $V_{IN} = 3.3V$ )		98		% of $V_{OUT}$
$V_{RDYHYS}$	System Ready Hysteresis	$R_{HYS} = 200K\Omega$		200		mV
$V_{RDY(L)}$	System Ready Voltage Low	$I_{SINK} = 1mA$			0.4	V
$I_{RDY}$	RDY_ Leakage Current	$V_{RDY} < 5.5V$ , $V_{OUT} < 98\%$ Of $V_{OUT}$			1	$\mu A$
OTMP	Shutdown Temperature	Thermal Shutdown Temperature		150		$^{\circ}C$
		Thermal Shutdown Hysteresis		15		

1. The AAT4621 is guaranteed to meet performance specification over the  $-40^{\circ}C$  to  $85^{\circ}C$  operating temperature range and is assured by design, characterization and correlation with statistical process controls.

# AAT4621

## PC Card Current Limit Interface and Capacitor Charger

### Typical Characteristics

**AAT4621 Output Current vs. Output Voltage**  
( $R_{SETU} = 383k\Omega$ ,  $25^\circ C$ )

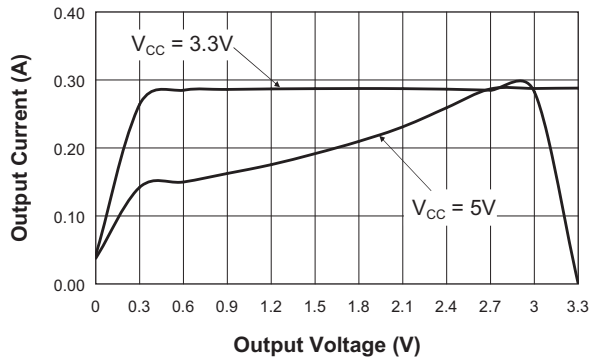

**AAT4621-1 Output Current vs. Output Voltage**  
( $R_{SETU} = 374k\Omega$ ;  $T_A = 25^\circ C$ )

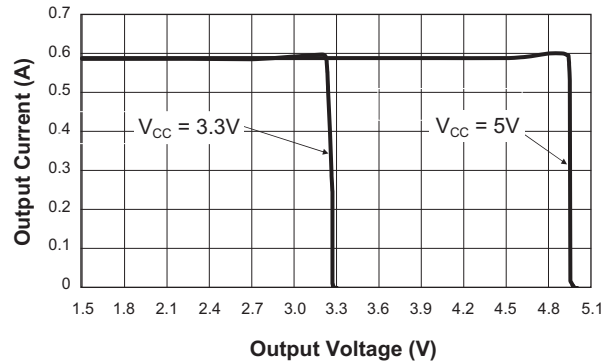

**AAT4621  $I_{LIM}$  vs.  $R_{SET}$**   
( $25^\circ C$ )

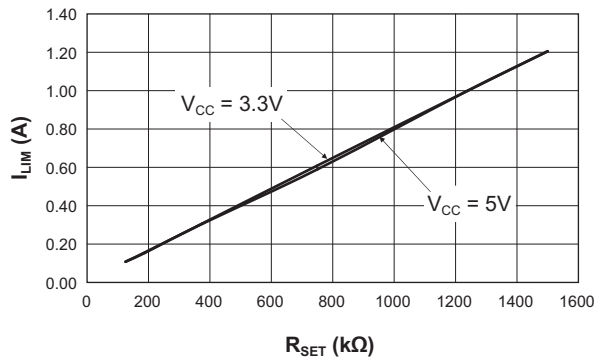

**AAT4621-1  $I_{LIM}$  vs.  $R_{SET}$**   
( $25^\circ C$ )

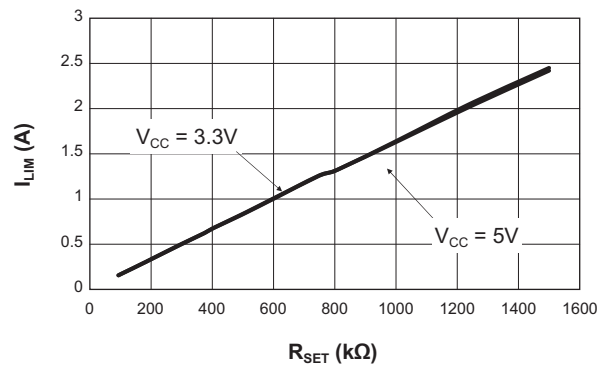

**Reverse Off-Switch Current vs. Temperature**  
( $ENIU = ENIL = High$ ;  $V_{CC} = 0V$ )

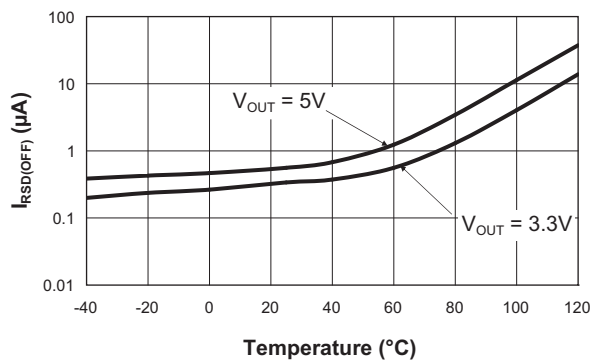

**Off-Switch Current vs. Temperature**  
( $ENIU = ENIL = High$ ;  $V_{OUT} = 0V$ )

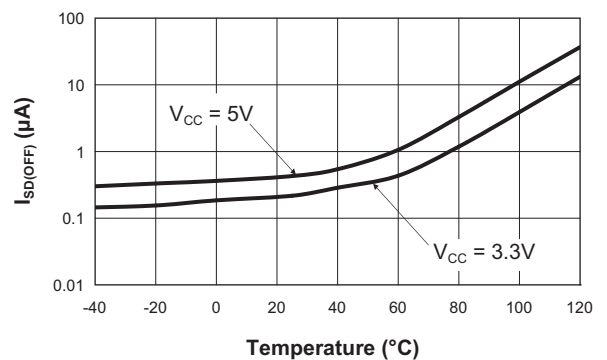

PC Card Current Limit Interface and Capacitor Charger

Typical Characteristics

Off-Supply Current vs. Temperature  
 (ENIU = ENIL = V<sub>CC</sub>; V<sub>OUT</sub> = Open)

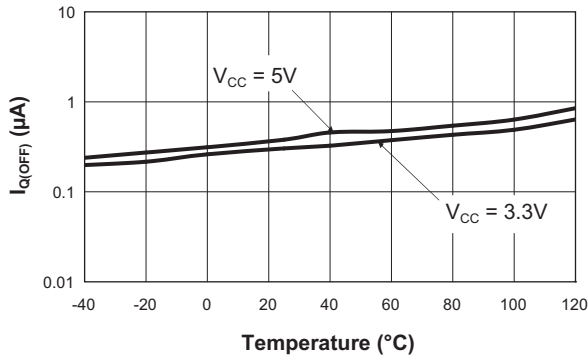

$R_{DS(ON)}$  vs. Input Voltage  
 ( $R_{SET} = 0k\Omega$ )

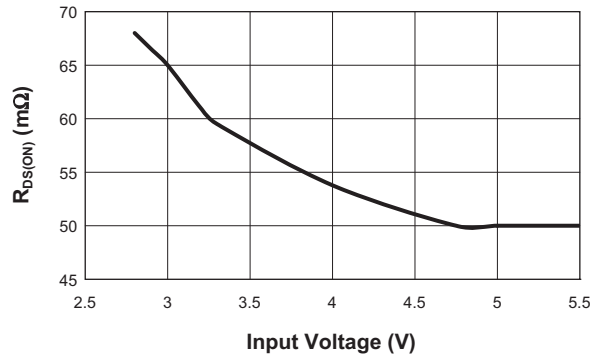

$R_{DS(ON)}$  vs. Temperature  
 ( $R_{SET} = 0\Omega$ )

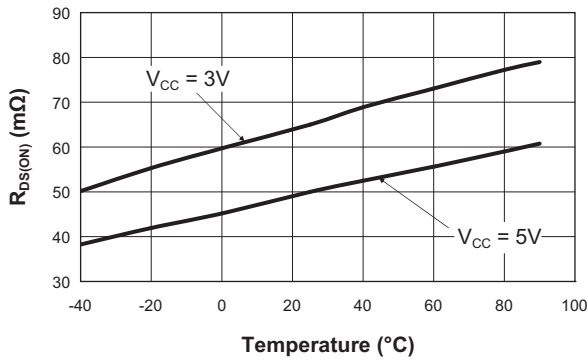

$V_{RHYS}$  vs.  $R_{RHYS}$

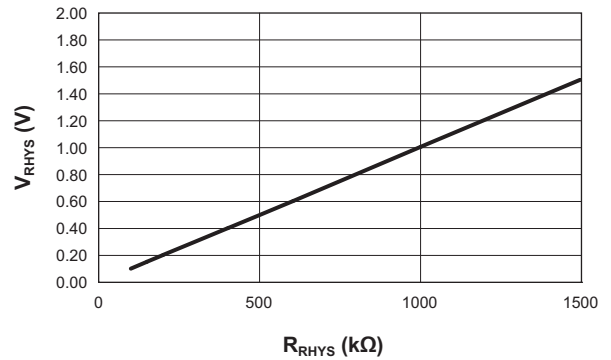

AAT4621  $I_{LIM}$  vs. Temperature  
 ( $V_{CC} = 4V$ ;  $V_{OUT} = 3.85V$ ;  $ENIL = 0V$ ;  $R_{SETL} = 249k\Omega$ )

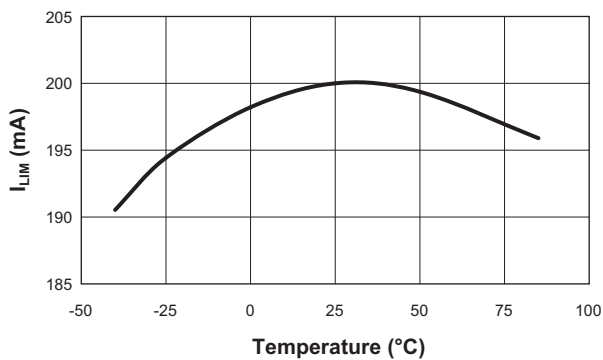

AAT4621  $I_{LIM}$  vs. Temperature  
 ( $V_{CC} = 4V$ ;  $V_{OUT} = 3.85V$ ;  $ENIU = 0V$ ;  $R_{SETU} = 1.3M\Omega$ )

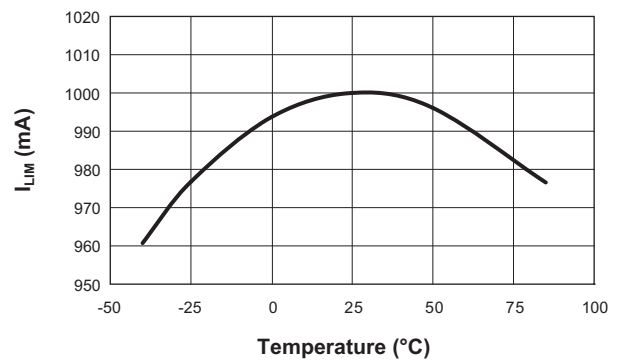

## PC Card Current Limit Interface and Capacitor Charger

### Typical Characteristics

**AAT4621-1  $I_{LIM}$  vs. Temperature**  
 ( $V_{CC} = 5V$ ;  $V_{OUT} = 4.5V$ ;  $ENIL = 0V$ ;  $R_{SETL} = 249k\Omega$ )

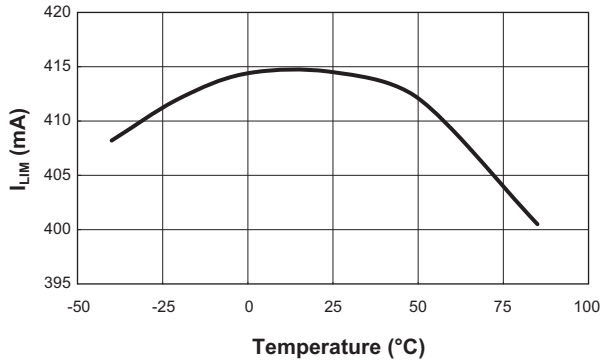

**AAT4621-1  $I_{LIM}$  vs. Temperature**  
 ( $V_{CC} = 5V$ ;  $V_{OUT} = 4.5V$ ;  $ENIU = 0V$ ;  $R_{SETU} = 1.24M\Omega$ )

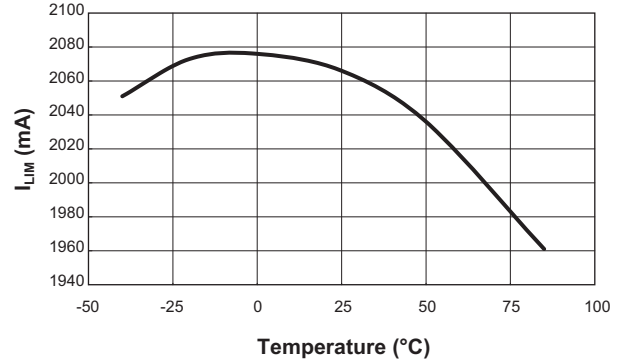

**Quiescent Current  $I_Q$  vs. Temperature**  
 ( $ENIU = 0V$ ;  $ENIL = V_{CC}$ ; or  $ENIL = 0V$ ;  
 $ENIU = V_{CC}$ ;  $V_{OUT} = Open$ )

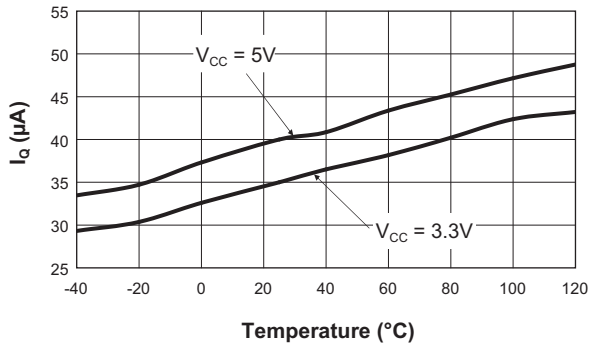

**$V_{EN(H)}$  and  $V_{EN(L)}$  vs. Input Voltage**  
 ( $ENIU = Open$ ; Vary  $ENIL$ ;  $T = 25^\circ C$ )

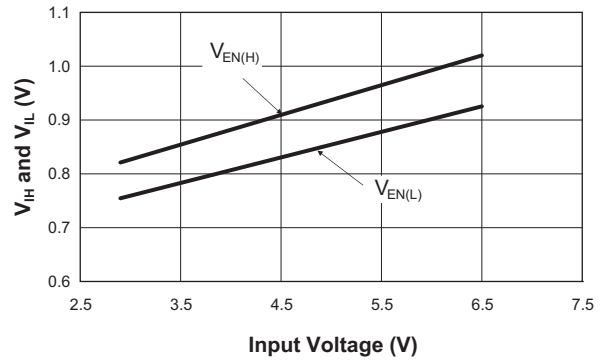

**$V_{EN(H)}$  and  $V_{EN(L)}$  vs. Input Voltage**  
 ( $ENIL = Open$ ; Vary  $ENIU$ ;  $T = 25^\circ C$ )

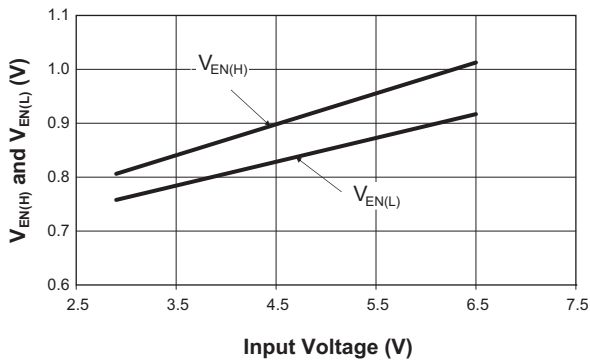

## PC Card Current Limit Interface and Capacitor Charger

### Typical Characteristics

**Hard Short Circuit**  
( $V_{CC} = 3.3V$ )

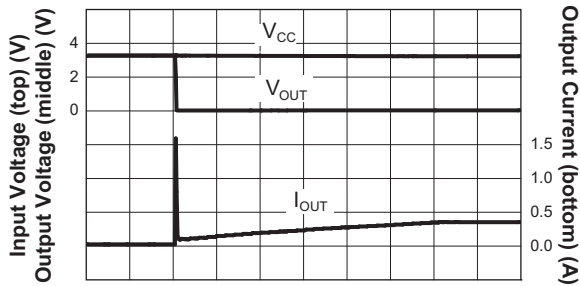

Time (20ms/div)

**Hard Short Circuit**  
( $V_{CC} = 5V$ )

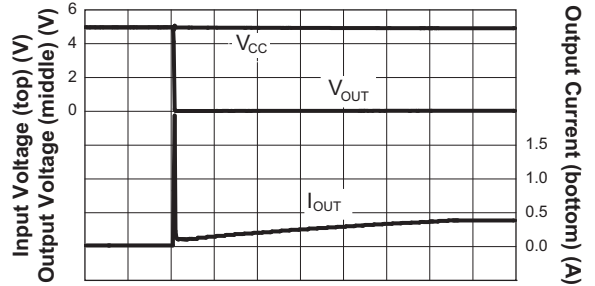

Time (20ms/div)

**Soft Short Circuit with 5Ω Series Impedance**  
( $V_{CC} = 3.3V$ )

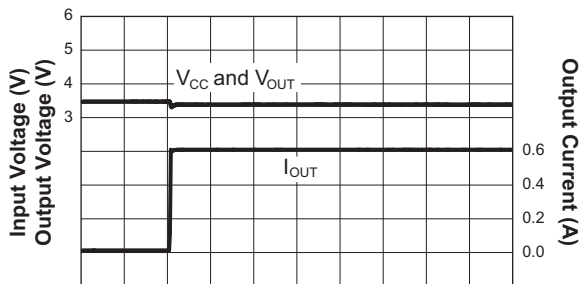

Time (2ms/div)

**Soft Short Circuit with 5Ω Series Impedance**  
( $V_{CC} = 5V$ )

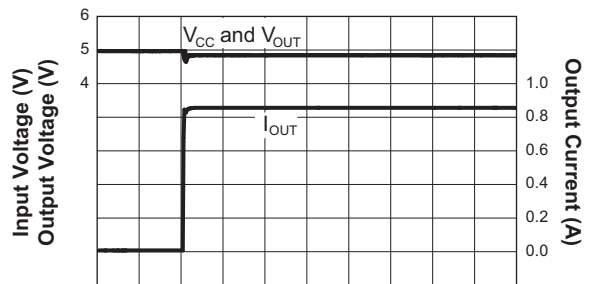

Time (2ms/div)

**Charging Profile**  
( $I_{LIMIT} = 150mA$ ;  $V_{CC} = 4.5V$ ;  $C_O = 0.55F$ )

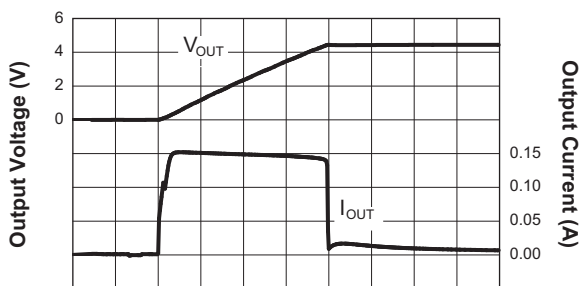

Time (5s/div)

**Charging Profile**  
( $I_{LIMIT} = 1A$ ;  $V_{CC} = 4.5V$ ;  $C_O = 0.55F$ )

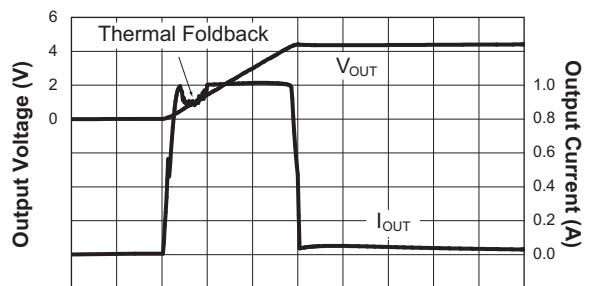

Time (1s/div)

## PC Card Current Limit Interface and Capacitor Charger

### Typical Characteristics

GSM900 GPRS Class 12 Transmit  
1-Slot Ch975, 33dBm

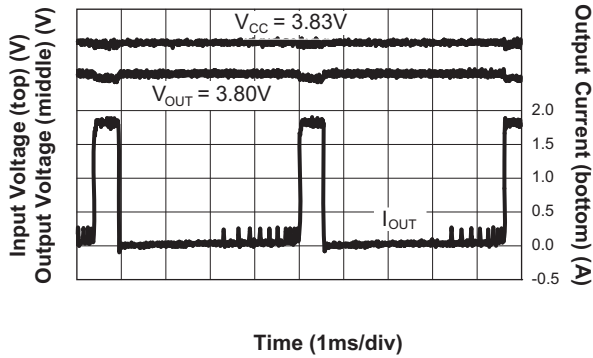

GSM900 GPRS Class 12 Transmit  
2-Slot Ch975, 33dBm

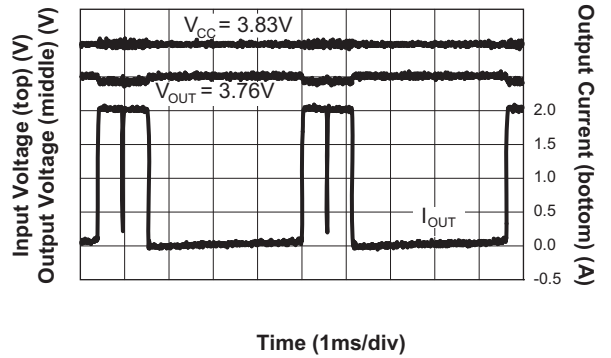

**PC Card Current Limit Interface and Capacitor Charger**

**Functional Block Diagram**

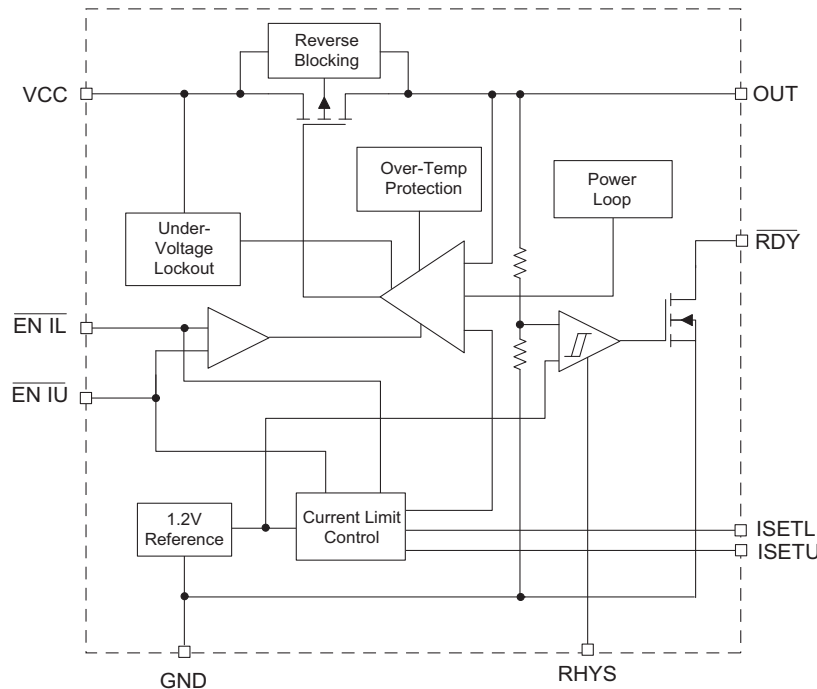

**Functional Description**

The AAT4621 SmartSwitch family is an integrated P-channel MOSFET load switch with an upper and lower adjustable current limits which can be enabled independently, over temperature protection, a power loop and a super capacitor charger. The current limit control is combined with an over temperature thermal limit and power loop circuit to provide a comprehensive system to protect the load switch and its supply from load conditions which exceed the supply specifications. The AAT4621 has been designed specifically to provide the interface between a PCMCIA host and PC card where a super capacitor has been used to “average out” high pulse currents which would otherwise exceed the PCMCIA/ Express Card power specifications. e.g. GSM/ GPRS modem cards, where pulse currents during transmit signals can exceed the 1A maximum specification (1.3A in the case of Express Card).

The current limit and over temperature circuits act independently. The device current limit is activated when the output load current exceeds an internal threshold level. There are two internal current limits which are enabled independently. The current limit threshold in each case is determined by external resistors connected between the two SET pins and ground. The minimum current limit

threshold is specified by  $I_{LIM(MIN)}$ . If the load condition maintains the device in current limit and the chip temperature reaches a critical point, then an internal power loop will reduce the current to a safe level. Connecting ISETU to ground disables the current limit protection allowing a low impedance path to the host  $V_{CC}$ .

The load switch is turned off by applying a logic high level to both of the EN pins. When both  $\overline{EN\ IL}$  and  $\overline{EN\ IU}$  are selected ISETU will be selected. The EN function has logic level thresholds that allow the AAT4621 to be TTL compatible and may also be controlled by 2.5V to 5.0V CMOS circuits. The voltage level applied to the EN pins should not exceed the input supply level present on the VCC pin. The AAT4621 typically consumes 40µA when operating, when off, the device draws less than 1µA. In the off state, current is prevented from flowing between the input and output.

Under-voltage lockout circuitry ensures that the  $V_{CC}$  supply is high enough for correct operation of the IC. Also included is a System Ready function which will be activated when the capacitor voltage is charged and the load is permitted to take current. For automatic functionality, this pin can be directly connected to the  $\overline{EN\ IU}$  pin. An external resistor is provided to add hysteresis to this function.

**PC Card Current Limit Interface and Capacitor Charger**

**Application Information**

**ISETU and ISETL Current Limit Set**

The AAT4621/AAT621-1 current limit is set at two different levels. Resistors from ISETL and ISETU set the lower and upper current limit levels respectively.

The ISETL and ISETU nodes operate within a window of 0.75V to 1.5V for resistor values ranging from 93.75Ω to 1.5MΩ. Resistor values outside this range are not recommended. The ISETL and ISETU source current varies with the resistor value used according to Table 1. To determine the resulting current limit multiply the  $R_{SETU}$  or  $R_{SETL}$  node voltage times the gain in Table 1. Note that the voltage at the node varies from 0.75V to 1.5V and the current limit gain varies depending on the resistor value used.

$$V_{ISET} = R_{SET} \cdot I_{ISET} = 0.75V \text{ to } 1.5V$$

If the set pin is open circuit or allowed to exceed 2V, all power devices are disabled and the input is disconnected from the output. Shorting the set pin to GND enables all power devices and shorts the  $V_{CC}$  to the output pin with no current limit.

To activate the upper current level ( $R_{SETU}$ ) pull  $\overline{EN\ I\bar{U}}$  low. To activate the lower current level ( $R_{SETL}$ ) pull  $\overline{EN\ I\bar{L}}$  low. If both  $\overline{EN\ I\bar{U}}$  and  $\overline{EN\ I\bar{L}}$  are pulled low the  $\overline{EN\ I\bar{U}}$  current limit level ( $R_{SETU}$ ) will be selected.

The AAT4621 has a current limit range from 75mA to 1200mA; the AAT4621-1 has a current limit range from 150mA to 2400mA.

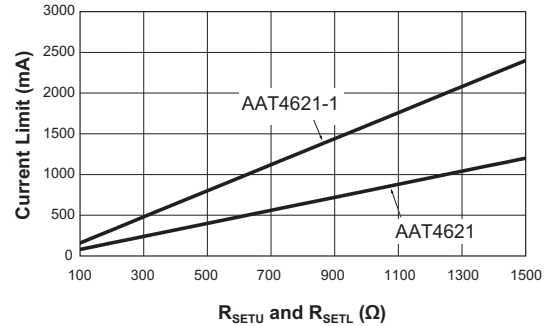

**Figure 1: Calculated Current Limit  $R_{SET}$  Characteristic.**

**System Ready Hysteresis (RHYS) and System Ready (RDY)**

In internal comparator senses the output voltage and delivers a ready signal to the external micro controller when the output voltage reaches 98% of the final value ( $V_{CC}$ ). The comparator hysteresis is programmed by a resistor from the RHYS pin to ground. The RHYS voltage determines the hysteresis voltage and is equal to the RHYS source current (1μA) times the RHYS resistance.

$$\begin{aligned} V_{HYST} &= R_{HYS} \cdot 1\mu A \\ &= 200k\Omega \cdot 1\mu A \\ &= 0.2V \end{aligned}$$

The system ready pin ( $\overline{RDY}$ ) is an open drain output that switches low when the output voltage reaches 98% of the input voltage. It requires an external pull up resistor tied to the input voltage with a typical value of 100kΩ.

$R_{SET}$ Range (Ω)	$I_{ISET}$ (μA)	$I_{LIM}/V_{ISET}$ (A/V)		Current Limit Range (A)		Current Limit (A)	
		AAT4621	AAT4621_1	AAT4621	AAT4621_1	AAT4621	AAT4621_1
1.5Meg -750K	1	0.8	1.6	1.2-0.6	2.4 - 1.2	$R_{SET} * 1 * 0.8$	$R_{SET} * 1 * 1.6$
750K -375K	2	0.4	0.8	0.6-0.3	1.2 - 0.6	$R_{SET} * 2 * 0.4$	$R_{SET} * 2 * 0.8$
375K -187.5K	4	0.2	0.4	0.3-0.15	0.6 -0.3	$R_{SET} * 4 * 0.2$	$R_{SET} * 4 * 0.4$
187.5K-93.75K	8	0.1	0.2	0.15-0.075	0.3 - 0.15	$R_{SET} * 8 * 0.1$	$R_{SET} * 8 * 0.2$

**Table 1:  $R_{SET}$  Table.**

## PC Card Current Limit Interface and Capacitor Charger

### **Power Loop**

The AAT4621 power loop limits the load current in the event that the device power dissipation becomes excessive. The AAT4621 power loop regulates the die temperature to 110°C (or 130°C for the AAT4621-1), decreasing the load current in increments of 1/32 of the current limit set point when the die temperature reaches 110°C (or 130°C for the AAT4621-1). When the die temperature exceeds 110°C (or 130°C for the AAT4621-1) it decreases the load current by 1/32 of the current limit set point. If die temperature is less than 110°C (or 130°C for the AAT4621-1), it increases the load current in increments of 1/32 of the current limit set point until the set current limit point is reached or the die temperature exceeds 110°C (or 130°C for the AAT4621-1).

The delay time between die temperature measurements varies depending on the load current limit set point. The delay ranges from 0.5ms for a 75mA (or 150mA for the AAT4621-1) current limit set point to 4ms for a 1.2A (or 2.4A for the AAT4621-1) current limit set point.

For the condition where there is no current limit set point (shorting  $R_{SETU}$  or  $R_{SETL}$  to ground) the soft start increments the current limit is 1/32 steps of 1.2A (or 2.4A for the AAT4621-1) until the current reaches 1.2A (or 2.4A for the AAT4621-1), at which point the power MOSFET turns on fully. At this point, the current is limited by the  $R_{DS(ON)}$  of the power MOSFET and other series resistance. The Power Loop and Over-Temperature Loop then takes control to limit the current until the output voltage has fully charged.

### **Short Circuit Protection**

The series pass power MOSFET turns off completely after the output has charged to within 18mV of the input voltage. This protects the device in the event where a short circuit is applied to the output. After applying a short circuit or heavy load to the output, which causes the output to sink below the 18mV threshold plus some hysteresis, the current will immediately attempt to slew from zero to the final programmed value. The device will continue to output the current limit as long as the output is  $V_{IN} - 18mV$  or until the die temperature reaches 110°C. If temperature fold-back occurs, then the power loop will become active.

### **Over-Temperature Protection**

If the die temperature rate of rise is fast enough to exceed the power loop regulated temperature, over-temperature shutdown disables the device. The over-temperature threshold is 145°C (or 150°C for the AAT4621-1). After over-temperature shutdown, soft start is initiated once the die temperature drops to 130°C (or 135°C for the AAT4621-1).

### **Under-Voltage Shutdown**

Under-voltage lockout enables the device at 2.7V typical with 120mV of hysteresis. The maximum UVLO level is 3.0V.

### **Digitally Programmed Soft Start Current Limit**

At turn on, the digital soft start increases the load current in discrete levels equal to 1/32 of the final programmed current limit set point from zero to the final programmed current limit level.

Once the AAT4621 has fully charged the supercap, the soft start circuit is disabled. The soft start function will only reactivate under the following conditions:

1. The power source or enable is cycled off and back on
2. The thermal shutdown is activated
3. Switching from  $\overline{ENIU}$  to  $\overline{ENIL}$  or vice versa
4. Following an over-current event.

### **Reverse Current Blocking**

An internal comparator disables the internal pass transistor when the input voltage is less than the output voltage blocking any reverse current from the output to the input.

### **Evaluation Board**

The AAT4621/AAT4621-1 evaluation board schematic is shown in Figure 2. The AAT4621/AAT4621-1 PCB layout is shown in Figures 3 and 4.

## PC Card Current Limit Interface and Capacitor Charger

### Layout Guidance

When laying out the PC board, the following layout guideline should be followed to ensure proper operation of the AAT4621/AAT4621-1:

1. The exposed pad EP must be reliably soldered to GND. The exposed thermal pad should be connected to the board ground plane and Pin 12. The ground plane should include a large exposed copper pad under the package with VIAs to all board layers for thermal dissipation.

2. The power traces, including GND traces and the VCC trace should be kept short, direct and wide to allow large current flow. Use several via pads when routing between layers.
3. The input capacitors (C1) should be connected as close as possible to VCC (Pins 8, 9, 10, 11) and GND (Pin 12) to get good power filtering.
4. The output capacitor (C2) should be connected as close as possible to OUT (Pins 5, 6, 7) and GND (Pin 12) to get good power filtering as the device will recharge the Supercap when the output voltage level sensed on the OUT pin is reduced by approximately 18-20mV below its input voltage (VCC) level.

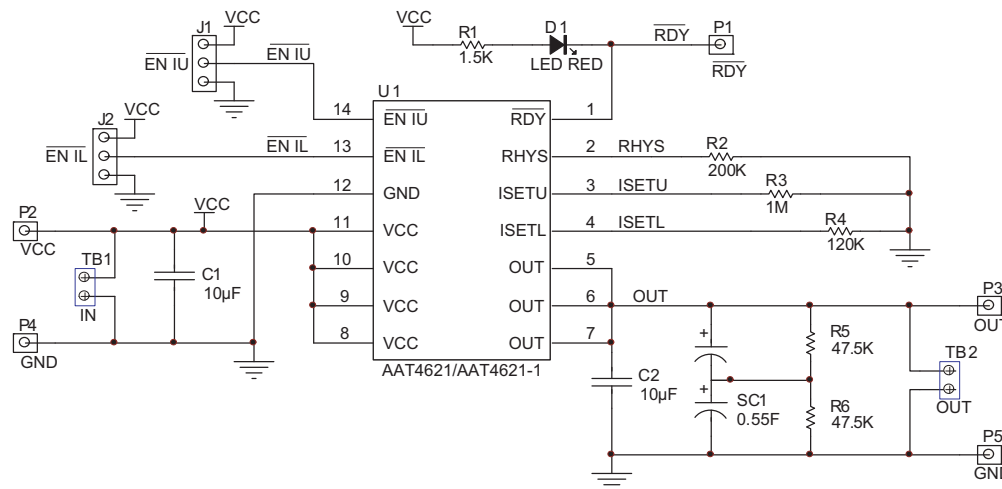

**Figure 2: AAT4621/AAT4621-1 Evaluation Board Schematic.**

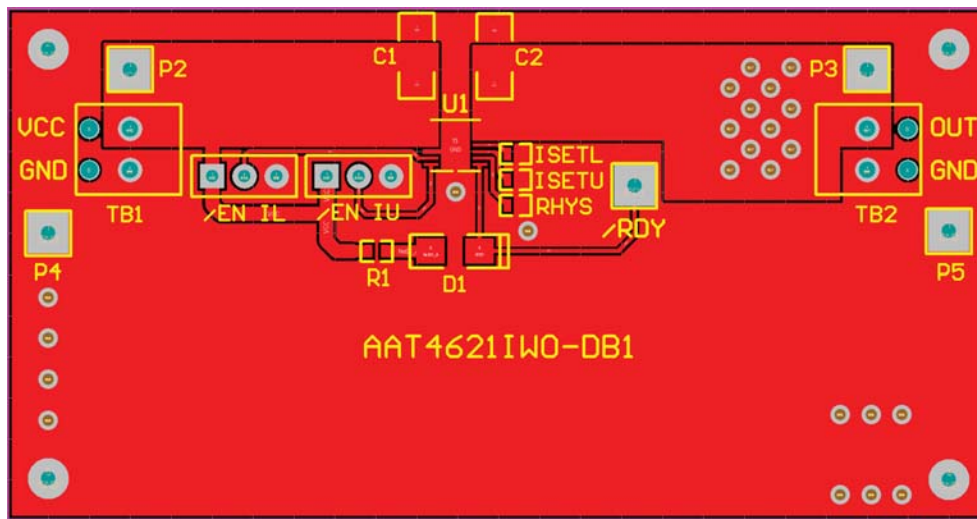

**Figure 3: AAT4621/AAT4621-1 Evaluation Board PCB Top Side.**

# AAT4621

## PC Card Current Limit Interface and Capacitor Charger

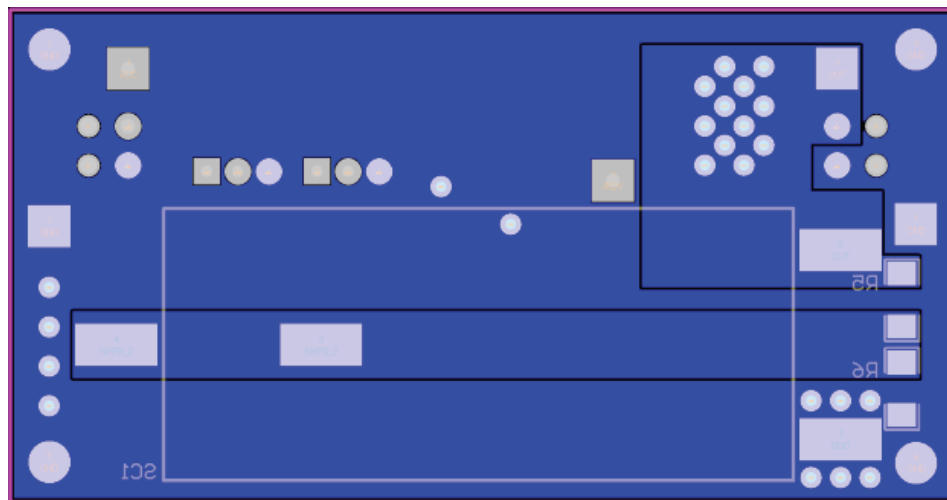

**Figure 4: AAT4621/AAT4621-1 Evaluation Board PCB Bottom Side.**

## PC Card Current Limit Interface and Capacitor Charger

### Ordering Information

Package	Marking <sup>1</sup>	Part Number (Tape and Reel) <sup>2</sup>
TDFN33-14	YWXY	<b>AAT4621IWO-T1</b>
TDFN33-14	K5XY	<b>AAT4621IWO-1-T1</b>



Skyworks Green™ products are compliant with all applicable legislation and are halogen-free.



For additional information, refer to *Skyworks Definition of Green™*, document number SQ04-0074.

### Package Information<sup>3</sup>

#### TDFN33-14

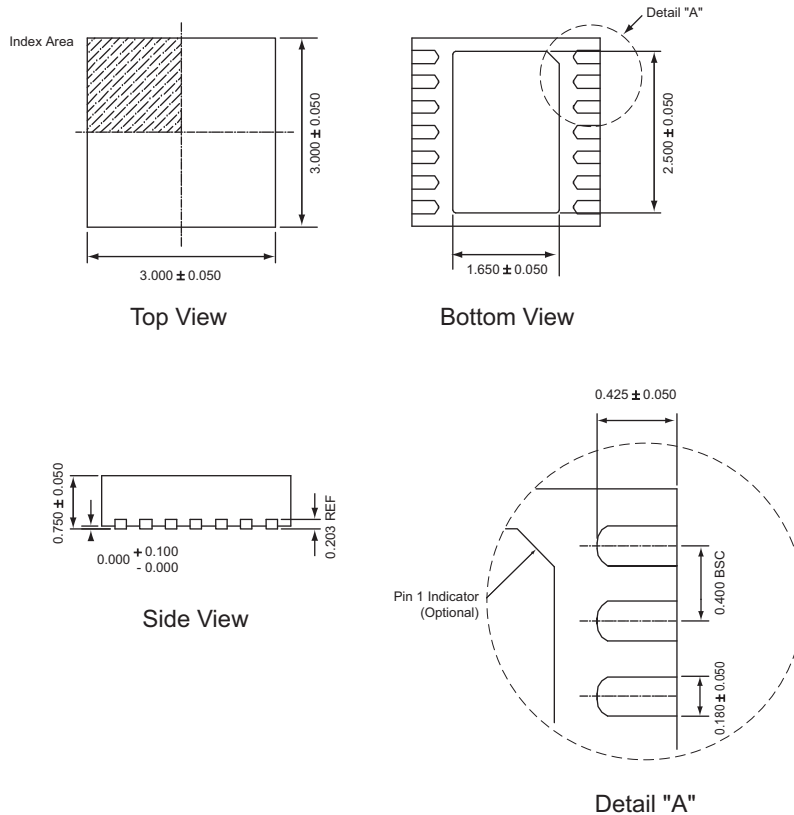

All dimensions in millimeters.

1. XYY = assembly and date code.  
 2. Sample stock is generally held on part numbers listed in **BOLD**.  
 3. The leadless package family, which includes QFN, TQFN, DFN, TDFN and STDFN, has exposed copper (unplated) at the end of the lead terminals due to the manufacturing process. A solder fillet at the exposed copper edge cannot be guaranteed and is not required to ensure a proper bottom solder connection.

---

**PC Card Current Limit Interface and Capacitor Charger**

Copyright © 2012 Skyworks Solutions, Inc. All Rights Reserved.

Information in this document is provided in connection with Skyworks Solutions, Inc. ("Skyworks") products or services. These materials, including the information contained herein, are provided by Skyworks as a service to its customers and may be used for informational purposes only by the customer. Skyworks assumes no responsibility for errors or omissions in these materials or the information contained herein. Skyworks may change its documentation, products, services, specifications or product descriptions at any time, without notice. Skyworks makes no commitment to update the materials or information and shall have no responsibility whatsoever for conflicts, incompatibilities, or other difficulties arising from any future changes.

No license, whether express, implied, by estoppel or otherwise, is granted to any intellectual property rights by this document. Skyworks assumes no liability for any materials, products or information provided hereunder, including the sale, distribution, reproduction or use of Skyworks products, information or materials, except as may be provided in Skyworks Terms and Conditions of Sale.

THE MATERIALS, PRODUCTS AND INFORMATION ARE PROVIDED "AS IS" WITHOUT WARRANTY OF ANY KIND, WHETHER EXPRESS, IMPLIED, STATUTORY, OR OTHERWISE, INCLUDING FITNESS FOR A PARTICULAR PURPOSE OR USE, MERCHANTABILITY, PERFORMANCE, QUALITY OR NON-INFRINGEMENT OF ANY INTELLECTUAL PROPERTY RIGHT; ALL SUCH WARRANTIES ARE HEREBY EXPRESSLY DISCLAIMED. SKYWORKS DOES NOT WARRANT THE ACCURACY OR COMPLETENESS OF THE INFORMATION, TEXT, GRAPHICS OR OTHER ITEMS CONTAINED WITHIN THESE MATERIALS. SKYWORKS SHALL NOT BE LIABLE FOR ANY DAMAGES, INCLUDING BUT NOT LIMITED TO ANY SPECIAL, INDIRECT, INCIDENTAL, STATUTORY, OR CONSEQUENTIAL DAMAGES, INCLUDING WITHOUT LIMITATION, LOST REVENUES OR LOST PROFITS THAT MAY RESULT FROM THE USE OF THE MATERIALS OR INFORMATION, WHETHER OR NOT THE RECIPIENT OF MATERIALS HAS BEEN ADVISED OF THE POSSIBILITY OF SUCH DAMAGE.



Skyworks products are not intended for use in medical, lifesaving or life-sustaining applications, or other equipment in which the failure of the Skyworks products could lead to personal injury, death, physical or environmental damage. Skyworks customers using or selling Skyworks products for use in such applications do so at their own risk and agree to fully indemnify Skyworks for any damages resulting from such improper use or sale.

Customers are responsible for their products and applications using Skyworks products, which may deviate from published specifications as a result of design defects, errors, or operation of products outside of published parameters or design specifications. Customers should include design and operating safeguards to minimize these and other risks. Skyworks assumes no liability for applications assistance, customer product design, or damage to any equipment resulting from the use of Skyworks products outside of stated published specifications or parameters.

Skyworks, the Skyworks symbol, and "Breakthrough Simplicity" are trademarks or registered trademarks of Skyworks Solutions, Inc., in the United States and other countries. Third-party brands and names are for identification purposes only, and are the property of their respective owners. Additional information, including relevant terms and conditions, posted at [www.skyworksinc.com](http://www.skyworksinc.com), are incorporated by reference.

## Looking for pricing, stock, or lifecycle information?

Click below to explore more details on WIN SOURCE:

-  [View AAT4621IWO-1-T1 on WIN SOURCE](#)
-  [Skyworks Solutions Inc. Information](#)

## Optimize Your Supply Chain with WIN SOURCE Solutions

-  Global Sourcing Solution
-  Obsolete Management
-  Cost Control Management
-  Shortage Management
-  Alternative Solution
-  Excess Inventory Management