



**THE DATASHEET OF  
THS3202DGNRG4**



## 2-GHz, LOW DISTORTION, DUAL CURRENT-FEEDBACK AMPLIFIERS

Check for Samples: [THS3202](#)

### FEATURES

- **Unity-Gain Bandwidth: 2 GHz**
- **High Slew Rate: 9000 V/μs**
- **High Output Current: ±115 mA into 20 Ω  $R_L$**
- **Power-Supply Voltage Range: 6.6 V to 15 V**

### APPLICATIONS

- **High-Speed Signal Processing**
- **Test and Measurement Systems**
- **High-Voltage ADC Preamplifier**
- **RF and IF Amplifier Stages**
- **Professional Video**

### DESCRIPTION

The THS3202 is a dual current-feedback amplifier developed with BiCOM-II technology. Designed for low distortion with a high slew rate of 9000 V/μs, the THS320x family is ideally suited for applications driving loads sensitive to distortion at high frequencies.

The THS3202 provides well-regulated ac performance characteristics with power supplies ranging from single-supply 6.6-V operation up to a 15-V supply. The high unity-gain bandwidth of up to 2 GHz is a major contributor to the excellent distortion performance. The THS3202 offers an output current drive of ±115 mA and a low differential gain and phase error that make it suitable for applications such as video line drivers.

The THS3202 is available in an SOIC-8, an MSOP-8, and an MSOP-8 with PowerPAD™ packages.

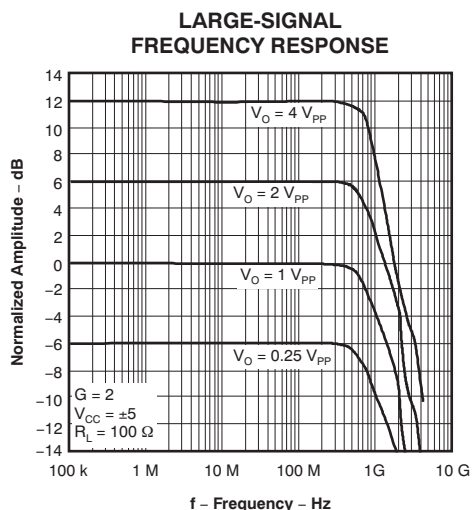

### RELATED DEVICES AND DESCRIPTIONS

<a href="#">THS3001</a>	±15-V 420-MHz Low Distortion CFB Amplifier
<a href="#">THS3061/2</a>	±15-V 300-MHz Low Distortion CFB Amplifier
<a href="#">THS3122</a>	±15-V Dual CFB Amplifier With 350 mA Drive
<a href="#">THS4271</a>	+15-V 1.4-GHz Low Distortion VFB Amplifier



Please be aware that an important notice concerning availability, standard warranty, and use in critical applications of Texas Instruments semiconductor products and disclaimers thereto appears at the end of this data sheet.

PowerPAD is a trademark of Texas Instruments.

All other trademarks are the property of their respective owners.



This integrated circuit can be damaged by ESD. Texas Instruments recommends that all integrated circuits be handled with appropriate precautions. Failure to observe proper handling and installation procedures can cause damage.

ESD damage can range from subtle performance degradation to complete device failure. Precision integrated circuits may be more susceptible to damage because very small parametric changes could cause the device not to meet its published specifications.

### PACKAGE/ORDERING INFORMATION<sup>(1)</sup>

NUMBER OF CHANNELS	ORDERABLE PACKAGE AND NUMBER				
	PLASTIC SOIC-8 <sup>(2)</sup> (D)	PLASTIC MSOP-8 <sup>(2)</sup> PowerPAD		PLASTIC MSOP-8 <sup>(2)</sup>	
		(DGN)	MARKING	(DGK)	MARKING
2	THS3202D	THS3202DGN	BEP	THS3202DGK	BEV

- (1) For the most current package and ordering information, see the Package Option Addendum at the end of this document, or see the TI web site at [www.ti.com](http://www.ti.com).
- (2) This package is available taped and reeled. To order this packaging option, add an **R** suffix to the part number (that is, THS3202DR).

### ABSOLUTE MAXIMUM RATINGS<sup>(1)</sup>

Over operating free-air temperature range, unless otherwise noted.

		UNIT
Supply voltage, $V_S$		16.5 V
Input voltage, $V_I$		$\pm V_S$
Differential input voltage, $V_{ID}$		$\pm 3$ V
Output current, $I_O$ <sup>(2)</sup>		175 mA
Continuous power dissipation		See <a href="#">Package Dissipation Ratings Table</a>
Maximum junction temperature, $T_J$ <sup>(3)</sup>		+150°C
Maximum junction temperature, continuous operation, long-term reliability, $T_J$ <sup>(4)</sup>		+125°C
Operating free-air temperature range, $T_A$		–40°C to +85°C
Storage temperature range, $T_{STG}$		–65°C to +150°C
ESD ratings:	HBM	3000 V
	CDM	1500 V
	MM	200 V

- (1) The absolute maximum ratings under any condition is limited by the constraints of the silicon process. Stresses above these ratings may cause permanent damage. Exposure to absolute maximum conditions for extended periods may degrade device reliability. These are stress ratings only, and functional operation of the device at these or any other conditions beyond those specified is not implied.
- (2) The THS3202 may incorporate a PowerPAD on the underside of the chip. This acts as a heat sink and must be connected to a thermally dissipative plane for proper power dissipation. Failure to do so may result in exceeding the maximum junction temperature which could permanently damage the device. See TI technical briefs [SLMA002](#) and [SLMA004](#) for more information about using the PowerPAD thermally-enhanced package.
- (3) The absolute maximum temperature under any condition is limited by the constraints of the silicon process.
- (4) The maximum junction temperature for continuous operation is limited by package constraints. Operation above this temperature may result in reduced reliability and/or lifetime of the device.

## PACKAGE DISSIPATION RATINGS

PACKAGE	$\theta_{JC}$ (°C/W)	$\theta_{JA}$ (1) (°C/W)	POWER RATING (2)	
			$T_A \leq +25^\circ\text{C}$	$T_A = +85^\circ\text{C}$
D (8 pin)	38.3	97.5	1.32 W	410 mW
DGN (8 pin)	4.7	58.4	1.71 W	685 mW
DGK (8 pin)	54.2	260	385 mW	154 mW

- (1) These data were taken using the JEDEC standard High-K test PCB.  
 (2) Power rating is determined with a junction temperature of +125°C. This is the point where distortion starts to substantially increase. Thermal management of the final PCB should strive to keep the junction temperature at or below +125°C for best performance and long-term reliability.

## RECOMMENDED OPERATING CONDITIONS

PARAMETER		MIN	MAX	UNIT
Supply voltage, ( $V_{S+}$ and $V_{S-}$ )	Dual supply	±3.3	±7.5	V
	Single supply	6.6	15	
Operating free-air temperature range		-40	+85	°C

## PIN ASSIGNMENTS

### D, DGN, AND DGK PACKAGES (TOP VIEW)

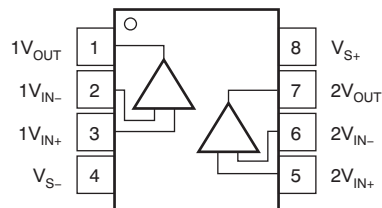

**ELECTRICAL CHARACTERISTICS:  $V_S = \pm 5\text{ V}$**

$V_S = \pm 5\text{ V}$ :  $R_F = 500\ \Omega$ ,  $R_L = 100\ \Omega$ , and  $G = +2$ , unless otherwise noted.

PARAMETER	TEST CONDITIONS	THS3202				UNIT	MIN/TYP/ MAX
		TYP	OVER TEMPERATURE				
		+25°C	+25°C	0°C to +70°C	-40°C to +85°C		
<b>AC PERFORMANCE</b>							
Small-signal bandwidth, -3 dB ( $V_O = 100\text{ mV}_{PP}$ )	$G = +1, R_F = 500\ \Omega$	1800				MHz	Typ
	$G = +2, R_F = 402\ \Omega$	975				MHz	Typ
	$G = +5, R_F = 300\ \Omega$	780				MHz	Typ
	$G = +10, R_F = 200\ \Omega$	550				MHz	Typ
Bandwidth for 0.1-dB flatness	$G = +2, V_O = 100\text{ mV}_{PP}, R_F = 536\ \Omega$	380				MHz	Typ
Large-signal bandwidth	$G = +2, V_O = 4\text{ V}_{PP}, R_F = 536\ \Omega$	875				MHz	Typ
Slew rate (25% to 75% level)	$G = -1, 5\text{-V step}$	5100				V/ $\mu\text{s}$	Typ
	$G = +2, 5\text{-V step}$	4400				V/ $\mu\text{s}$	Typ
Rise and fall time	$G = +2, V_O = 5\text{-V step}$	0.45				ns	Typ
Settling time to 0.1%	$G = -2, V_O = 2\text{-V step}$	19				ns	Typ
Settling time to 0.01%	$G = -2, V_O = 2\text{-V step}$	118				ns	Typ
Harmonic distortion	$G = +2, f = 16\text{ MHz}, V_O = 2\text{ V}_{PP}$						
2nd harmonic	$R_L = 100\ \Omega$	-64				dBc	Typ
	$R_L = 500\ \Omega$	-67				dBc	Typ
3rd harmonic	$R_L = 100\ \Omega$	-67				dBc	Typ
	$R_L = 500\ \Omega$	-69				dBc	Typ
3rd-order intermodulation distortion	$G = +5, f_C = 120\text{ MHz}, \Delta f = 200\text{ kHz}, V_{O(\text{envelope})} = 2\text{ V}_{PP}$	-64				dBc	Typ
Input voltage noise	$f > 10\text{ MHz}$	1.65				nV/ $\sqrt{\text{Hz}}$	Typ
Input current noise (noninverting)	$f > 10\text{ MHz}$	13.4				pA/ $\sqrt{\text{Hz}}$	Typ
Input current noise (inverting)	$f > 10\text{ MHz}$	20				pA/ $\sqrt{\text{Hz}}$	Typ
Crosstalk	$G = +2, f = 100\text{ MHz}$	-60				dB	Typ
Differential gain (NTSC, PAL)	$G = +2, R_L = 150\ \Omega$	0.008				%	Typ
Differential phase (NTSC, PAL)	$G = +2, R_L = 150\ \Omega$	0.03				Degrees	Typ
<b>DC PERFORMANCE</b>							
Open-loop transimpedance gain	$V_O = \pm 1\text{ V}, R_L = 1\text{ k}\Omega$	300	200	140	120	k $\Omega$	Min
Input offset voltage	$V_{CM} = 0\text{ V}$	$\pm 0.7$	$\pm 3$	$\pm 3.8$	$\pm 4$	mV	Max
Average offset voltage drift	$V_{CM} = 0\text{ V}$			$\pm 10$	$\pm 13$	$\mu\text{V}/^\circ\text{C}$	Typ
Input bias current (inverting)	$V_{CM} = 0\text{ V}$	$\pm 13$	$\pm 60$	$\pm 80$	$\pm 85$	$\mu\text{A}$	Max
Average bias current drift (-)	$V_{CM} = 0\text{ V}$			$\pm 300$	$\pm 400$	nA/ $^\circ\text{C}$	Typ
Input bias current (noninverting)	$V_{CM} = 0\text{ V}$	$\pm 14$	$\pm 35$	$\pm 45$	$\pm 50$	$\mu\text{A}$	Max
Average bias current drift (+)	$V_{CM} = 0\text{ V}$			$\pm 300$	$\pm 400$	nA/ $^\circ\text{C}$	Typ

**ELECTRICAL CHARACTERISTICS:  $V_S = \pm 5\text{ V}$  (continued)**
 $V_S = \pm 5\text{ V}$ ;  $R_F = 500\ \Omega$ ,  $R_L = 100\ \Omega$ , and  $G = +2$ , unless otherwise noted.

PARAMETER	TEST CONDITIONS	THS3202				UNIT	MIN/TYP/ MAX
		TYP	OVER TEMPERATURE				
		+25°C	+25°C	0°C to +70°C	–40°C to +85°C		
<b>INPUT</b>							
Common-mode input range		±2.6	±2.5	±2.5	±2.5	V	Min
Common-mode rejection ratio	$V_{CM} = \pm 2.5\text{ V}$	71	60	58	58	dB	Min
Input resistance	Noninverting	780				k $\Omega$	Typ
	Inverting	11				$\Omega$	Typ
Input capacitance	Noninverting	1				pF	Typ
<b>OUTPUT</b>							
Voltage output swing	$R_L = 1\text{ k}\Omega$	±3.65	±3.5	±3.45	±3.4	V	Min
	$R_L = 100\ \Omega$	±3.45	±3.3	±3.25	±3.2	V	Min
Current output, sourcing	$R_L = 20\ \Omega$	115	105	100	100	mA	Min
Current output, sinking	$R_L = 20\ \Omega$	100	85	80	80	mA	Min
Closed-loop output impedance	$G = +1$ , $f = 1\text{ MHz}$	0.01				$\Omega$	Typ
<b>POWER SUPPLY</b>							
Minimum operating voltage	Absolute minimum		±3	±3	±3	V	Min
Maximum quiescent current	Per amplifier	14	16.8	19	20	mA	Max
Power-supply rejection (+PSRR)	$V_{S+} = 4.5\text{ V to } 5.5\text{ V}$	69	63	60	60	dB	Min
Power-supply rejection (–PSRR)	$V_{S-} = -4.5\text{ V to } -5.5\text{ V}$	65	58	55	55	dB	Min

**ELECTRICAL CHARACTERISTICS:  $V_S = 15\text{ V}$** 
 $V_S = 15\text{ V}$ :  $R_F = 500\ \Omega$ ,  $R_L = 100\ \Omega$ , and  $G = +2$ , unless otherwise noted.

PARAMETER	TEST CONDITIONS	THS3202				UNITS	MIN/TYP/ MAX
		TYP	OVER TEMPERATURE				
		+25°C	+25°C	0°C to +70°C	–40°C to +85°C		
<b>AC PERFORMANCE</b>							
Small-signal bandwidth, –3 dB ( $V_O = 100\text{ mV}_{PP}$ )	$G = +1$ , $R_F = 550\ \Omega$	2000				MHz	Typ
	$G = +2$ , $R_F = 550\ \Omega$	1100				MHz	Typ
	$G = +5$ , $R_F = 300\ \Omega$	850				MHz	Typ
	$G = +10$ , $R_F = 200\ \Omega$	750				MHz	Typ
Bandwidth for 0.1-dB flatness	$G = +2$ , $V_O = 100\text{ mV}_{PP}$ , $R_F = 536\ \Omega$	500				MHz	Typ
Large-signal bandwidth	$G = +2$ , $V_O = 4\text{ V}_{PP}$ , $R_F = 536\ \Omega$	1000				MHz	Typ
Slew rate (25% to 75% level)	$G = +5$ , 5-V step	7500				V/ $\mu\text{s}$	Typ
	$G = +2$ , 10-V step	9000				V/ $\mu\text{s}$	Typ
Rise and fall time	$G = +2$ , $V_O = 10\text{-V step}$	0.45				ns	Typ
Settling time to 0.1%	$G = -2$ , $V_O = 2\text{-V step}$	23				ns	Typ
Settling time to 0.01%	$G = -2$ , $V_O = 2\text{-V step}$	112				ns	Typ
Input voltage noise	$f > 10\text{ MHz}$	1.65				nV/ $\sqrt{\text{Hz}}$	Typ
Input current noise (noninverting)	$f > 10\text{ MHz}$	13.4				pA/ $\sqrt{\text{Hz}}$	Typ
Input current noise (inverting)	$f > 10\text{ MHz}$	20				pA/ $\sqrt{\text{Hz}}$	Typ
Crosstalk	$G = +2$ , $f = 100\text{ MHz}$	–60				dB	Typ
Differential gain (NTSC, PAL)	$G = +2$ , $R_L = 150\ \Omega$	0.004				%	Typ
Differential phase (NTSC, PAL)	$G = +2$ , $R_L = 150\ \Omega$	0.006				Degrees	Typ
<b>DC PERFORMANCE</b>							
Open-loop transimpedance gain	$V_O = 6.5\text{ V to } 8.5\text{ V}$ , $R_L = 1\text{ k}\Omega$	300	200	140	120	k $\Omega$	Min
Input offset voltage	$V_{CM} = 7.5\text{ V}$	$\pm 1.3$	$\pm 4$	$\pm 4.8$	$\pm 5$	mV	Max
Average offset voltage drift	$V_{CM} = 7.5\text{ V}$			$\pm 10$	$\pm 13$	$\mu\text{V}/^\circ\text{C}$	Typ
Input bias current (inverting)	$V_{CM} = 7.5\text{ V}$	$\pm 16$	$\pm 60$	$\pm 80$	$\pm 85$	$\mu\text{A}$	Max
Average bias current drift (–)	$V_{CM} = 7.5\text{ V}$			$\pm 300$	$\pm 400$	nA/ $^\circ\text{C}$	Typ
Input bias current (noninverting)	$V_{CM} = 7.5\text{ V}$	$\pm 14$	$\pm 35$	$\pm 45$	$\pm 50$	$\mu\text{A}$	Max
Average bias current drift (+)	$V_{CM} = 7.5\text{ V}$			$\pm 300$	$\pm 400$	nA/ $^\circ\text{C}$	Typ
<b>INPUT</b>							
Common-mode input range		2.4 to 12.6	2.5 to 12.5	2.5 to 12.5	2.5 to 12.5	V	Min
Common-mode rejection ratio	$V_{CM} = 5\text{ V to } 10\text{ V}$	69	60	58	58	dB	Min
Input resistance	Noninverting	780				k $\Omega$	Typ
	Inverting	11				$\Omega$	Typ
Input capacitance	Noninverting	1				pF	Typ
<b>OUTPUT</b>							
Voltage output swing	$R_L = 1\text{ k}\Omega$	1.5 to 13.5	1.6 to 13.4	1.7 to 13.3	1.7 to 13.3	V	Min
	$R_L = 100\ \Omega$	1.7 to 13.3	1.8 to 13.2	2.0 to 13.0	2.0 to 13.0	V	Min
Current output, sourcing	$R_L = 20\ \Omega$	120	105	100	100	mA	Min
Current output, sinking	$R_L = 20\ \Omega$	115	95	90	90	mA	Min
Closed-loop output impedance	$G = +1$ , $f = 1\text{ MHz}$	0.01				$\Omega$	Typ
<b>POWER SUPPLY</b>							
Maximum quiescent current/channel	Per amplifier	15	18	21	21	mA	Max
Power-supply rejection (+PSRR)	$V_{S+} = 14.50\text{ V to } 15.50\text{ V}$	69	63	60	60	dB	Min
Power-supply rejection (–PSRR)	$V_{S-} = -0.5\text{ V to } +0.5\text{ V}$	65	58	55	55	dB	Min

## TYPICAL CHARACTERISTICS

### Table of Graphs

		FIGURE
Small-signal frequency response		<a href="#">Figure 1-Figure 14</a>
Large-signal frequency response		<a href="#">Figure 15-Figure 18</a>
Harmonic distortion	vs Frequency	<a href="#">Figure 19-Figure 24</a>
Harmonic distortion	vs Output voltage	<a href="#">Figure 25-Figure 32</a>
IMD3	vs Frequency	<a href="#">Figure 33, Figure 34</a>
OIP3	vs Frequency	<a href="#">Figure 35, Figure 36</a>
Test circuit for IMD3/OIP3		<a href="#">Figure 37</a>
S-parameter	vs Frequency	<a href="#">Figure 38-Figure 41</a>
Input current noise density	vs Frequency	<a href="#">Figure 42</a>
Voltage noise density	vs Frequency	<a href="#">Figure 43</a>
Transimpedance	vs Frequency	<a href="#">Figure 44</a>
Output impedance	vs Frequency	<a href="#">Figure 45</a>
Impedance of inverting input		<a href="#">Figure 46</a>
Supply current/channel	vs Supply voltage	<a href="#">Figure 47</a>
Input offset voltage	vs Free-air temperature	<a href="#">Figure 48</a>
Offset voltage	vs Common-mode input voltage range	<a href="#">Figure 49</a>
Input bias current	vs Free-air temperature	<a href="#">Figure 50</a>
	vs Input common-mode range	<a href="#">Figure 51</a>
Positive power-supply rejection ratio	vs Positive power supply	<a href="#">Figure 52</a>
Negative power-supply rejection ratio	vs Negative power supply	<a href="#">Figure 53</a>
Positive output voltage swing	vs Free-air temperature	<a href="#">Figure 54, Figure 55</a>
Negative output voltage swing	vs Free-air temperature	<a href="#">Figure 56, Figure 57</a>
Output current sinking	vs Power supply	<a href="#">Figure 58</a>
Output current sourcing	vs Power supply	<a href="#">Figure 59</a>
Overdrive recovery time		<a href="#">Figure 60, Figure 61</a>
Slew rate	vs Output voltage	<a href="#">Figure 62-Figure 64</a>
Output voltage transient response		<a href="#">Figure 65</a>
Settling time		<a href="#">Figure 66, Figure 67</a>
DC common-mode rejection ratio high	vs Input common-mode range	<a href="#">Figure 68</a>
Power-supply rejection ratio	vs Frequency	<a href="#">Figure 69, Figure 70</a>
Differential gain error	vs 150- $\Omega$ loads	<a href="#">Figure 71, Figure 72, Figure 75</a>
Differential phase error	vs 150- $\Omega$ loads	<a href="#">Figure 73, Figure 74, Figure 76</a>

**TYPICAL CHARACTERISTICS**

**SMALL-SIGNAL FREQUENCY RESPONSE**

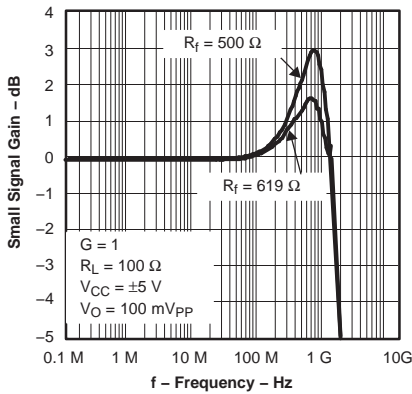

Figure 1.

**SMALL-SIGNAL FREQUENCY RESPONSE**

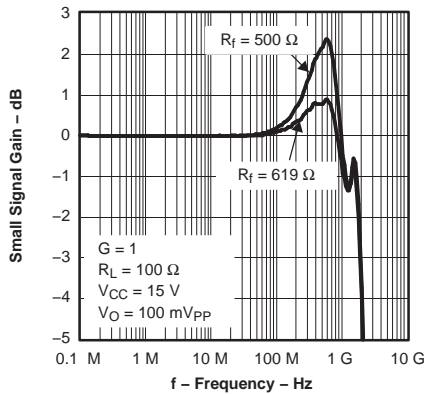

Figure 2.

**SMALL-SIGNAL FREQUENCY RESPONSE**

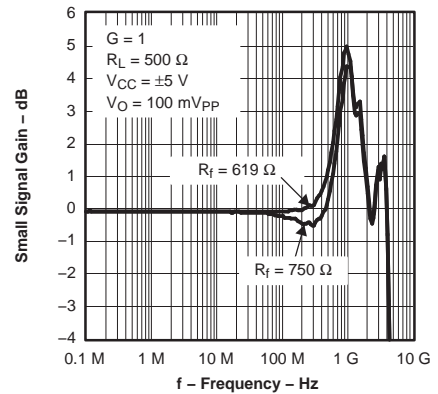

Figure 3.

**SMALL-SIGNAL FREQUENCY RESPONSE**

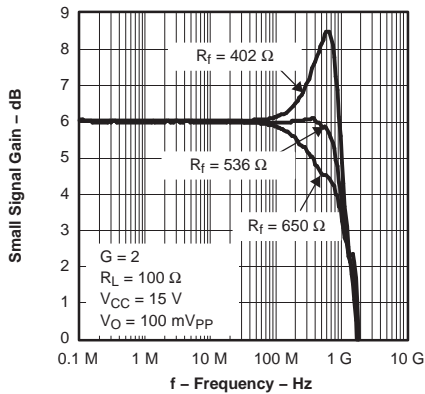

Figure 4.

**SMALL-SIGNAL FREQUENCY RESPONSE**

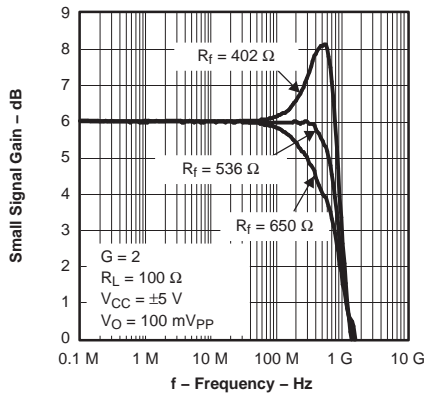

Figure 5.

**SMALL-SIGNAL FREQUENCY RESPONSE**

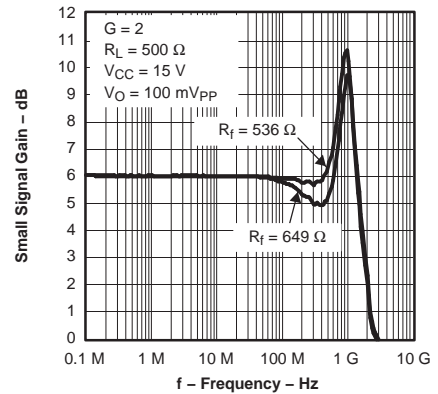

Figure 6.

**SMALL-SIGNAL FREQUENCY RESPONSE**

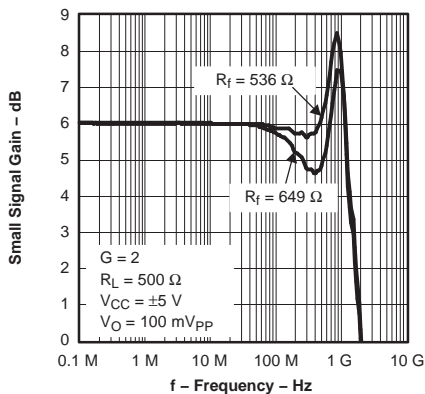

Figure 7.

**SMALL-SIGNAL FREQUENCY RESPONSE**

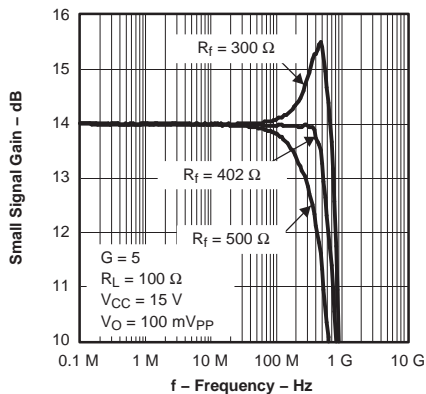

Figure 8.

**SMALL-SIGNAL FREQUENCY RESPONSE**

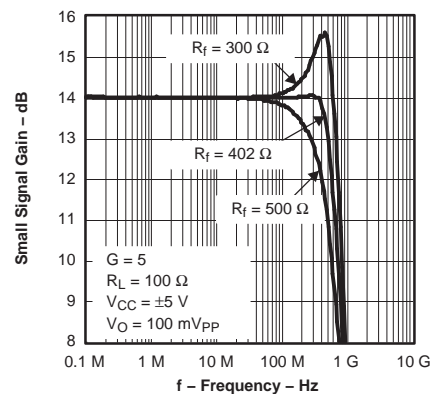

Figure 9.

TYPICAL CHARACTERISTICS (continued)

SMALL-SIGNAL FREQUENCY RESPONSE

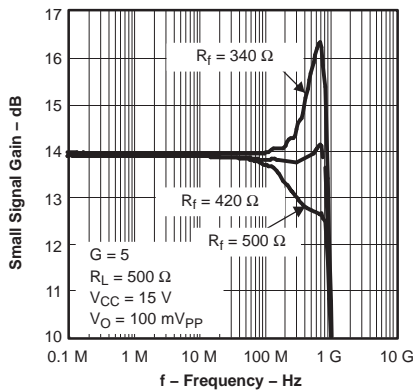

Figure 10.

SMALL-SIGNAL FREQUENCY RESPONSE

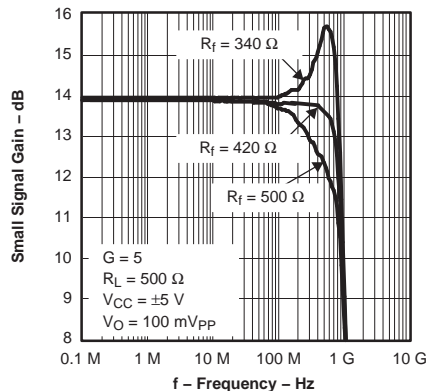

Figure 11.

SMALL-SIGNAL FREQUENCY RESPONSE

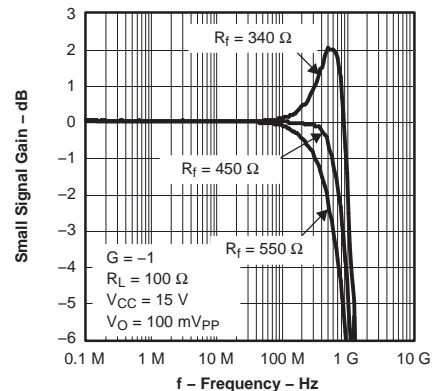

Figure 12.

SMALL-SIGNAL FREQUENCY RESPONSE

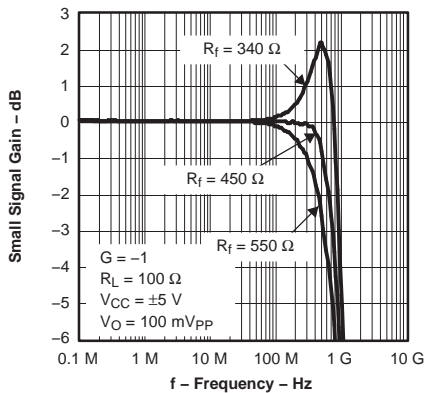

Figure 13.

SMALL-SIGNAL FREQUENCY RESPONSE

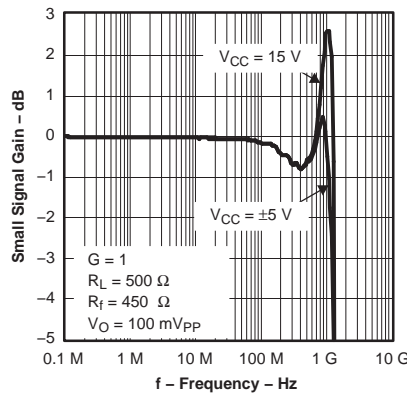

Figure 14.

LARGE-SIGNAL FREQUENCY RESPONSE

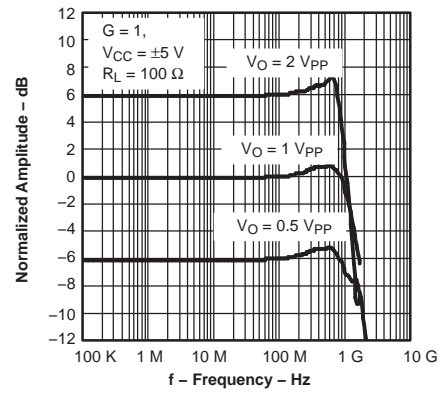

Figure 15.

LARGE-SIGNAL FREQUENCY RESPONSE

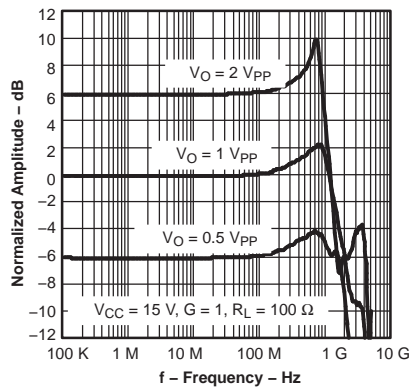

Figure 16.

LARGE-SIGNAL FREQUENCY RESPONSE

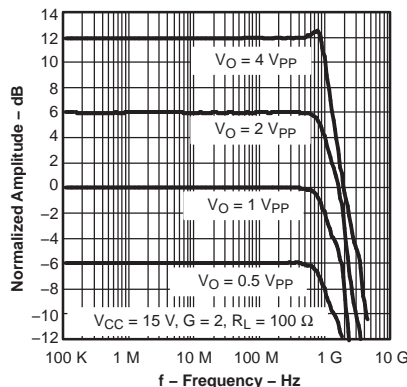

Figure 17.

LARGE-SIGNAL FREQUENCY RESPONSE

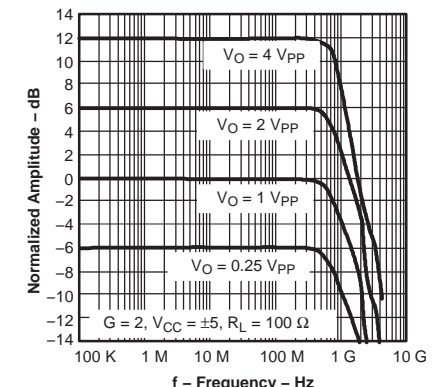

Figure 18.

TYPICAL CHARACTERISTICS (continued)

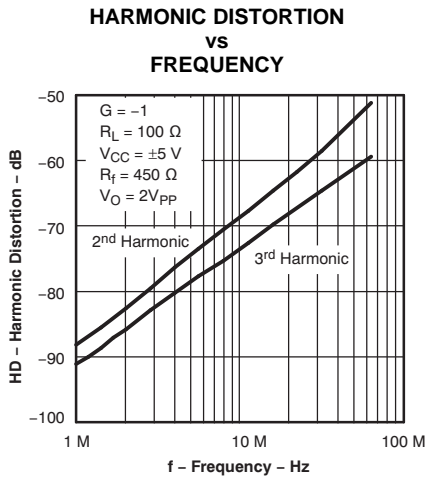

Figure 19.

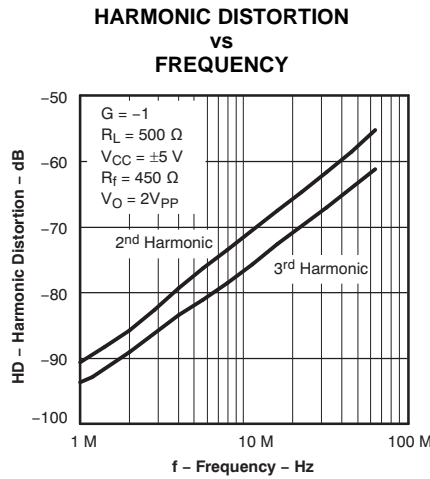

Figure 20.

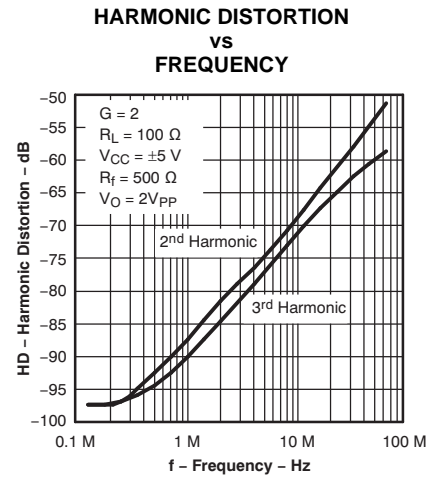

Figure 21.

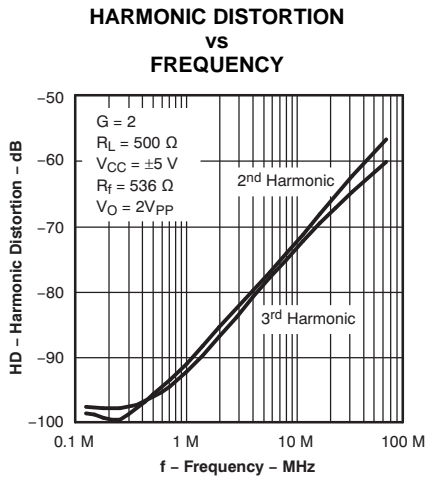

Figure 22.

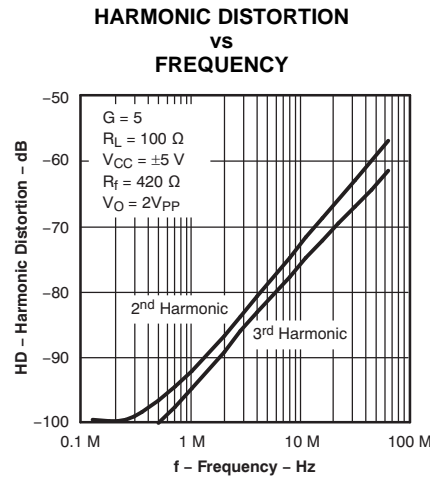

Figure 23.

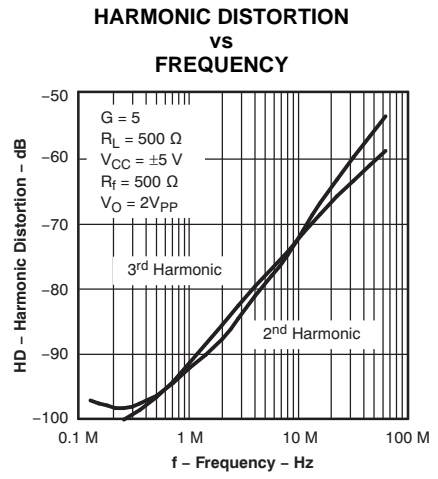

Figure 24.

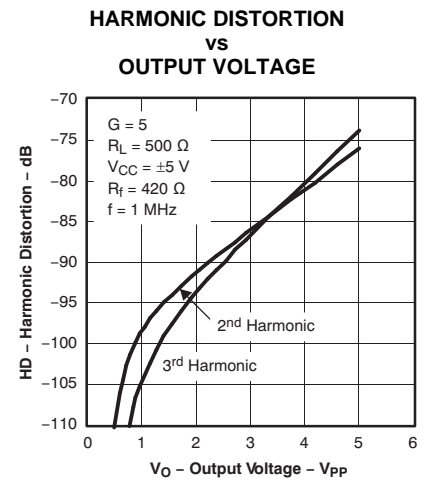

Figure 25.

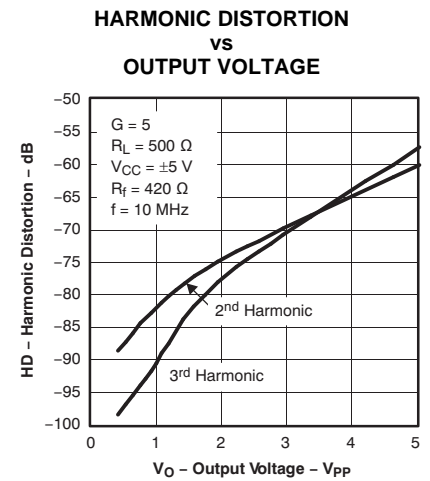

Figure 26.

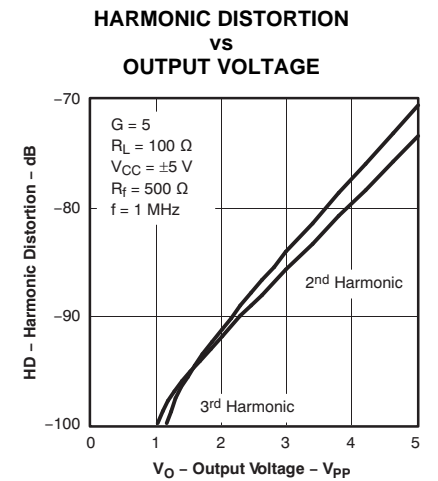

Figure 27.

TYPICAL CHARACTERISTICS (continued)

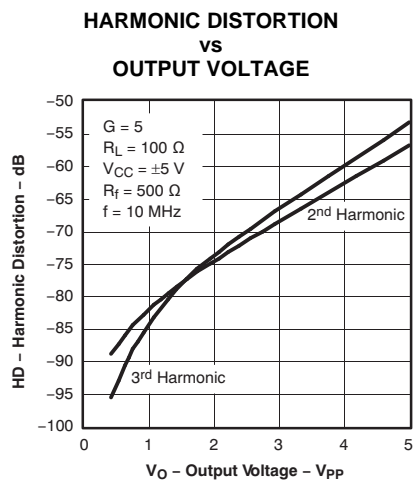

Figure 28.

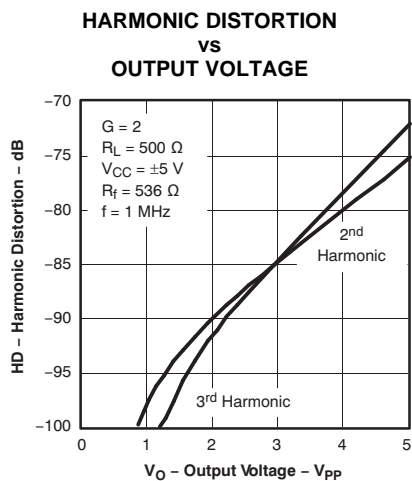

Figure 29.

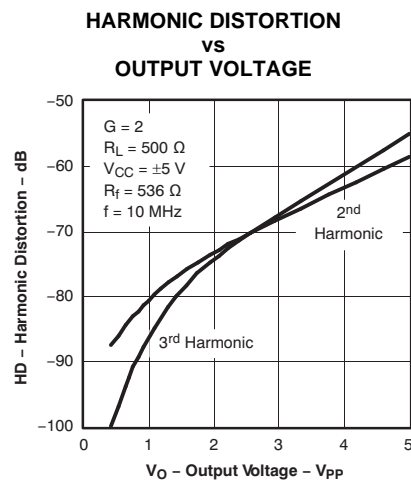

Figure 30.

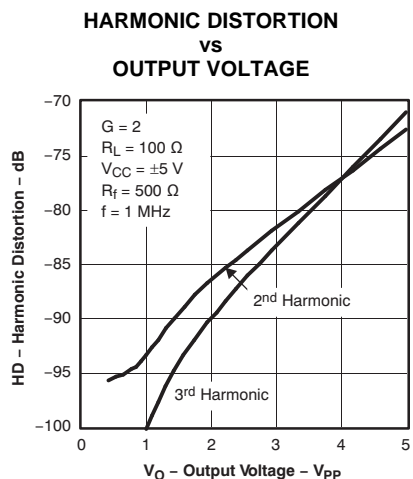

Figure 31.

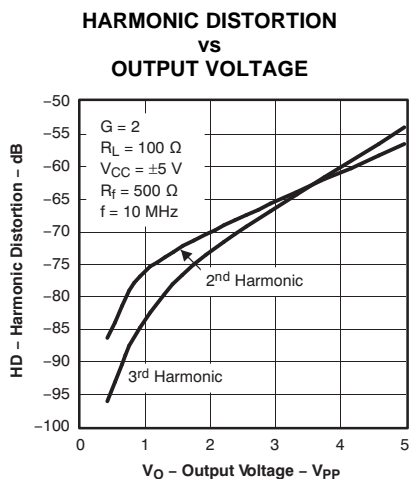

Figure 32.

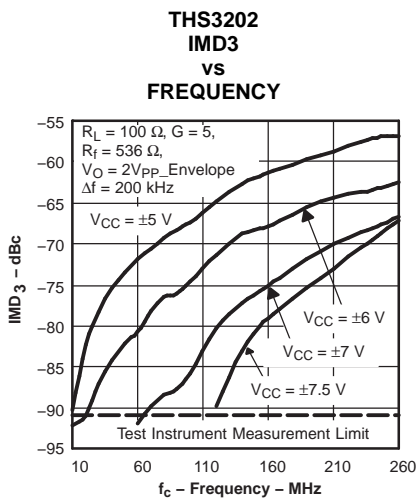

Figure 33.

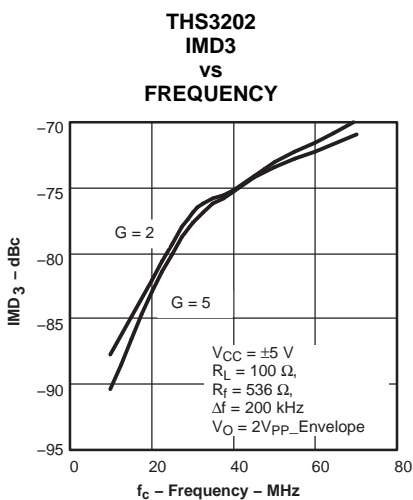

Figure 34.

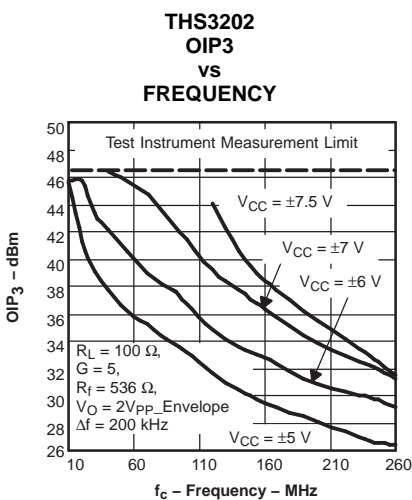

Figure 35.

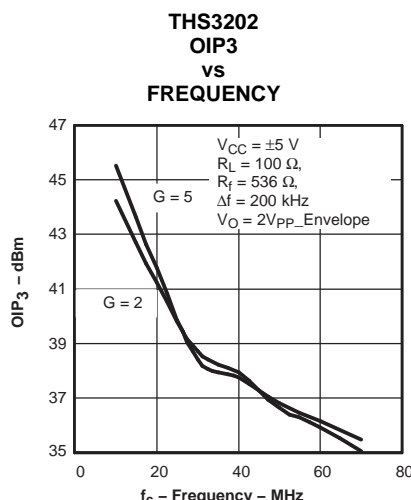
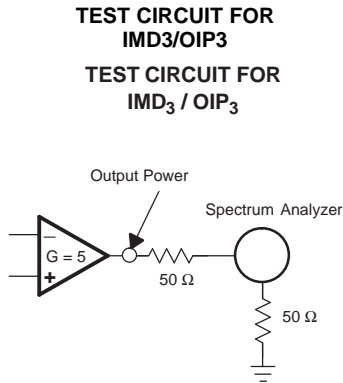

Figure 36.

TYPICAL CHARACTERISTICS (continued)



This circuit applies to figures 46 through 49

Figure 37.

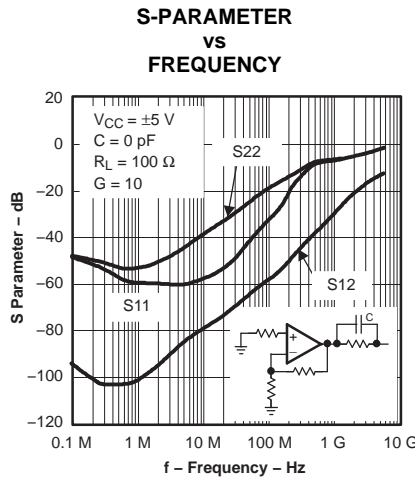

Figure 38.

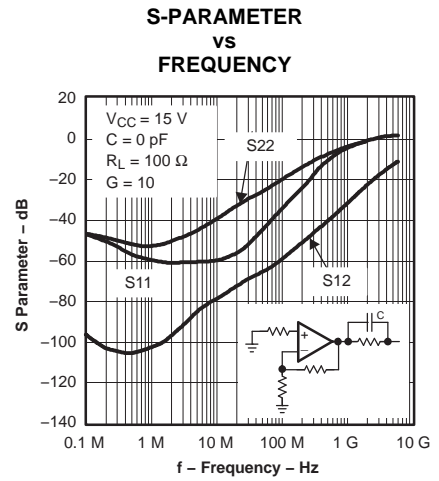

Figure 39.

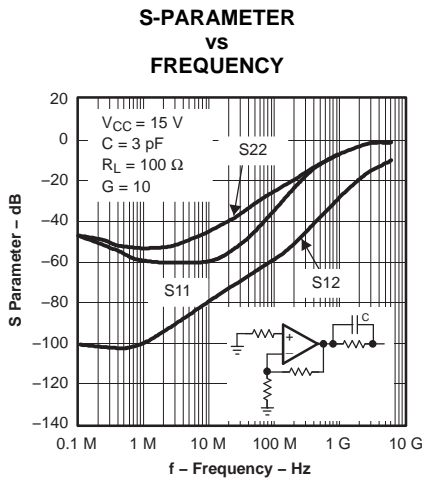

Figure 40.

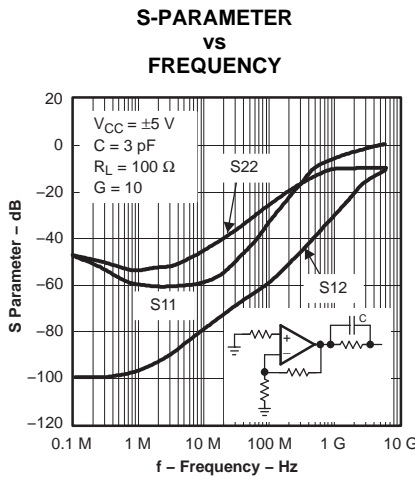

Figure 41.

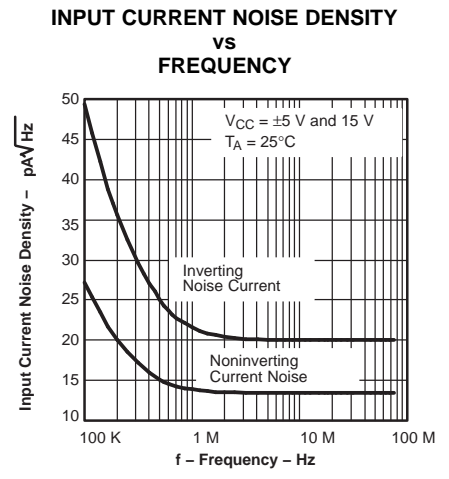

Figure 42.

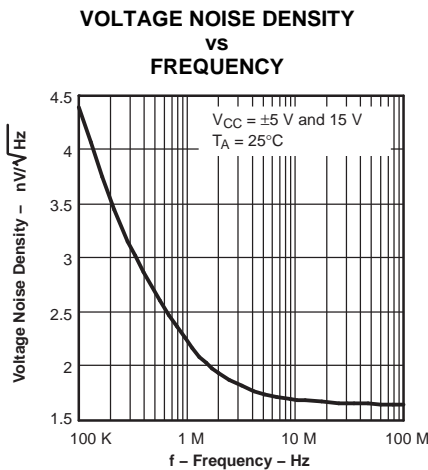

Figure 43.

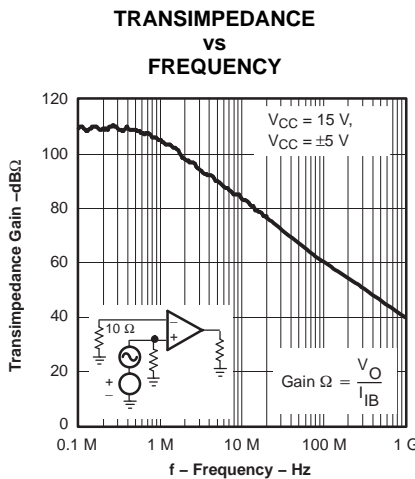

Figure 44.

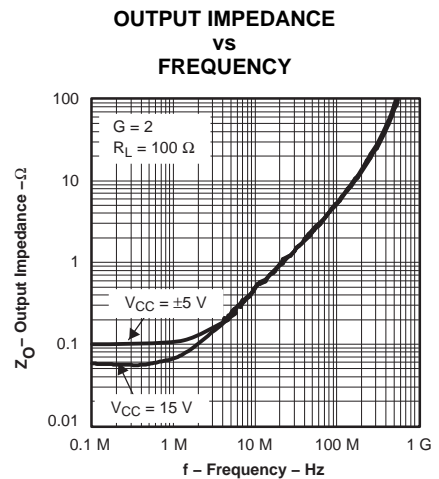

Figure 45.

TYPICAL CHARACTERISTICS (continued)

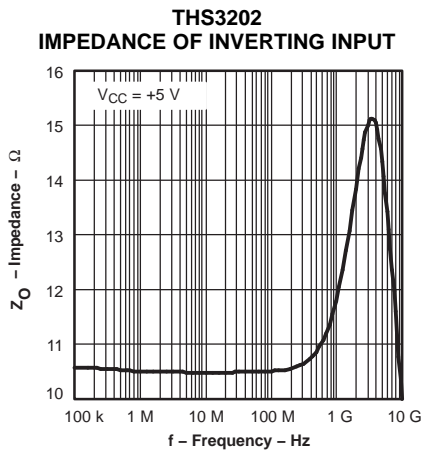

Figure 46.

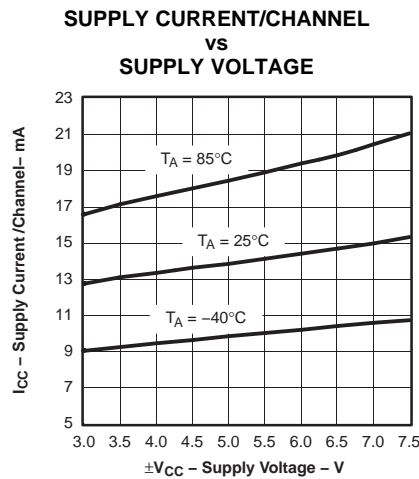

Figure 47.

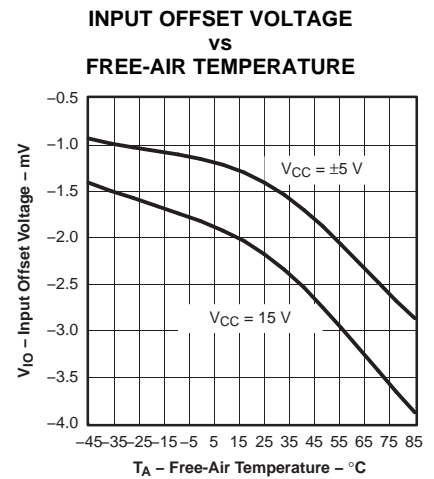

Figure 48.

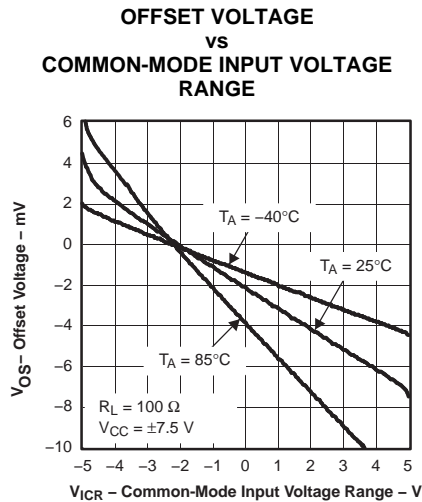

Figure 49.

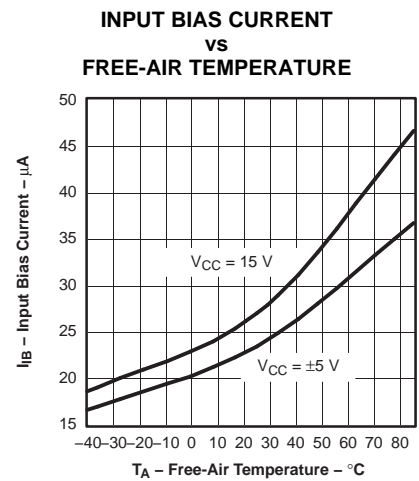

Figure 50.

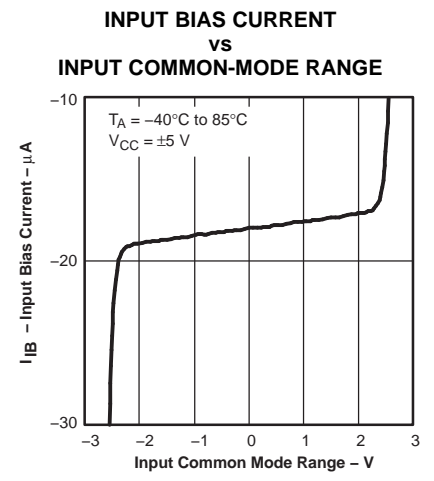

Figure 51.

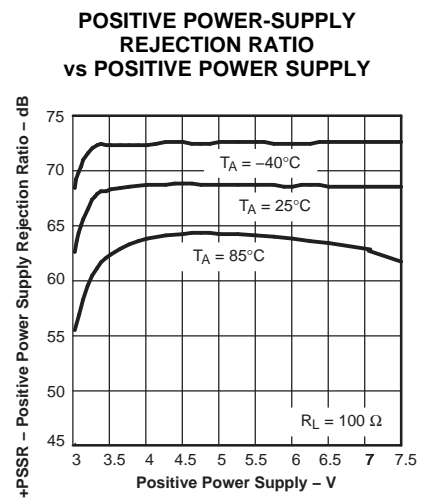

Figure 52.

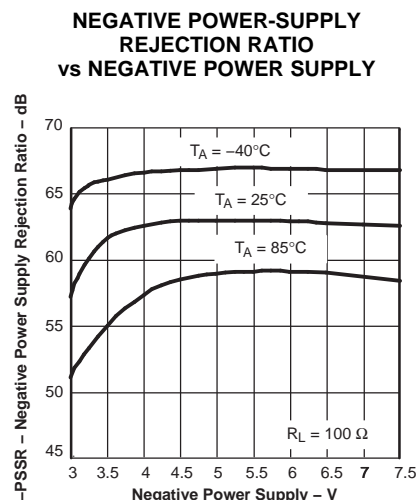

Figure 53.

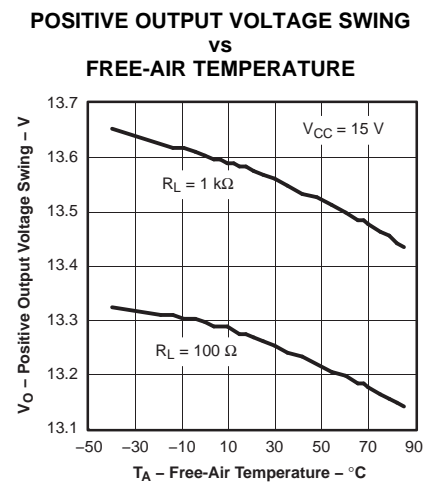

Figure 54.

**TYPICAL CHARACTERISTICS (continued)**

**POSITIVE OUTPUT VOLTAGE SWING  
vs  
FREE-AIR TEMPERATURE**

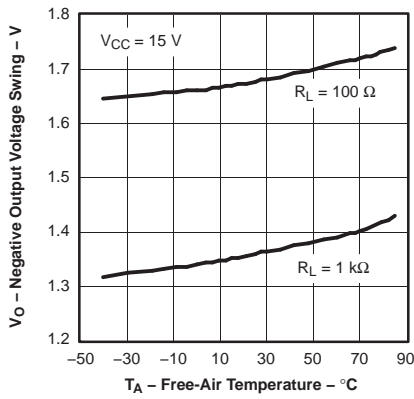

Figure 55.

**NEGATIVE OUTPUT VOLTAGE SWING  
vs  
FREE-AIR TEMPERATURE**

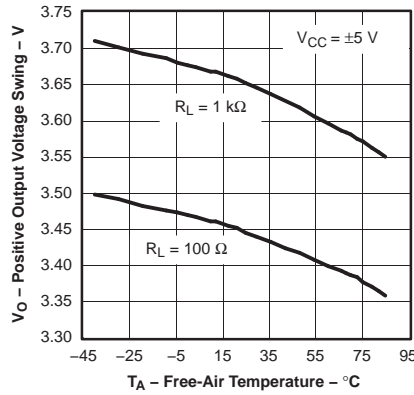

Figure 56.

**NEGATIVE OUTPUT VOLTAGE SWING  
vs  
FREE-AIR TEMPERATURE**

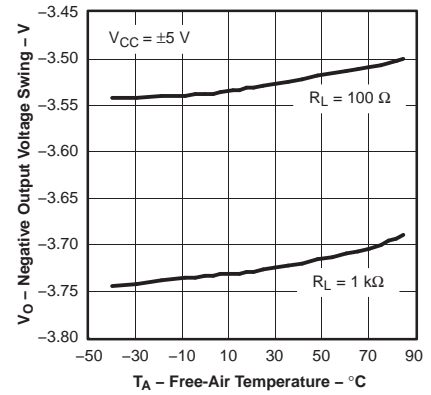

Figure 57.

**OUTPUT CURRENT SINKING  
vs  
POWER SUPPLY**

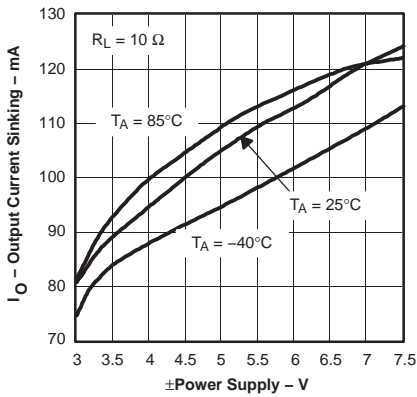

Figure 58.

**OUTPUT CURRENT SOURCING  
vs  
POWER SUPPLY**

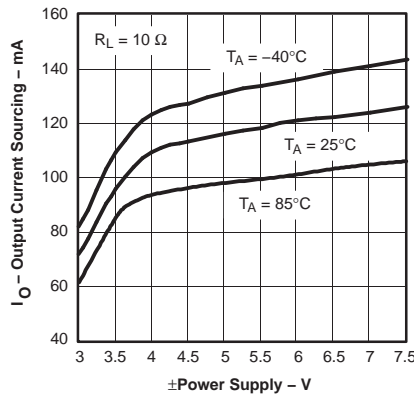

Figure 59.

**OVERDRIVE RECOVERY TIME**

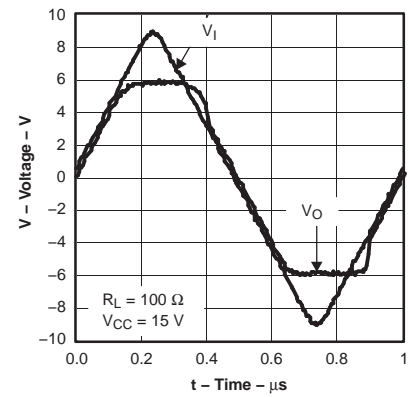

Figure 60.

**OVERDRIVE RECOVERY TIME**

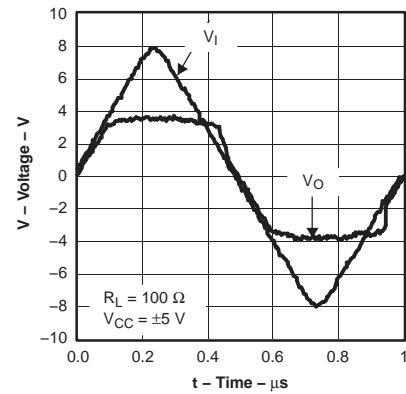

Figure 61.

**SLEW RATE  
vs  
OUTPUT VOLTAGE**

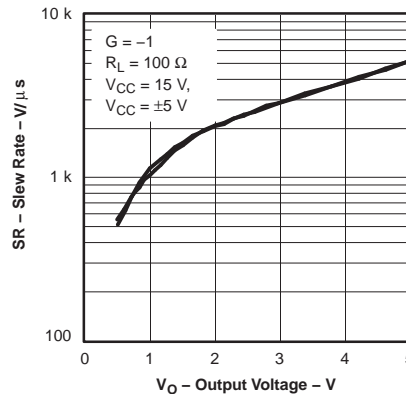

Figure 62.

**SLEW RATE  
vs  
OUTPUT VOLTAGE**

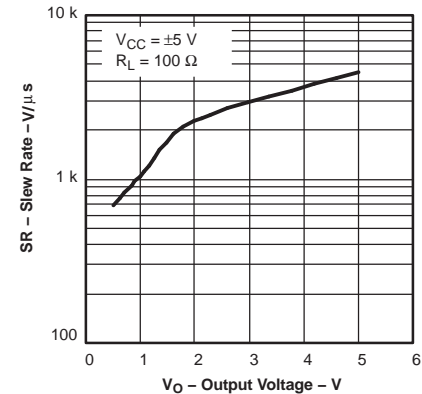

Figure 63.

TYPICAL CHARACTERISTICS (continued)

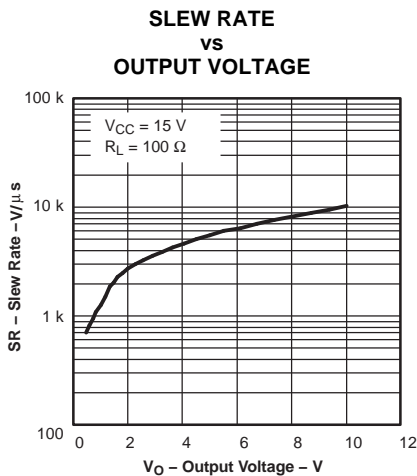

Figure 64.

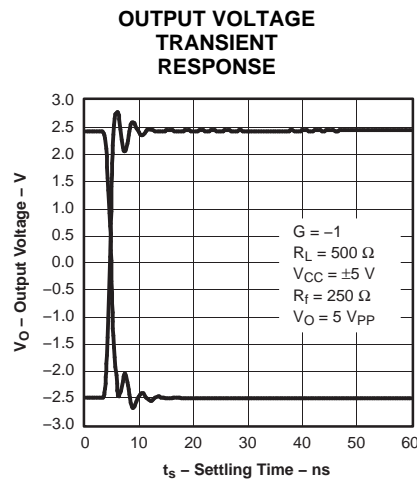

Figure 65.

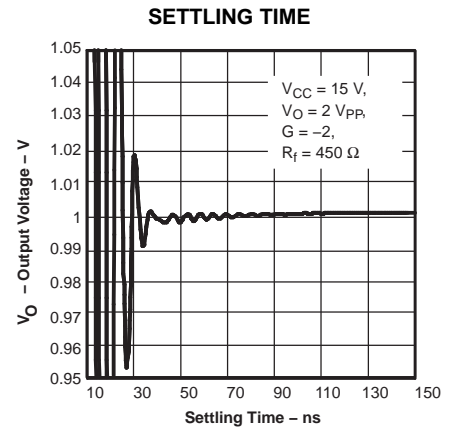

Figure 66.

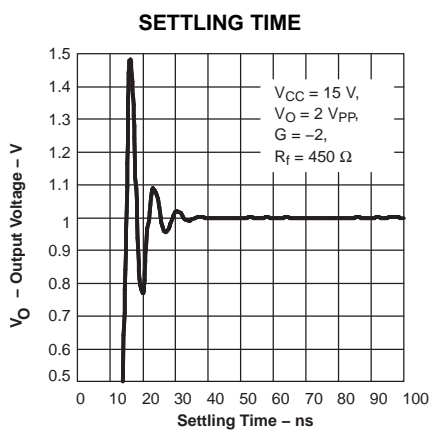

Figure 67.

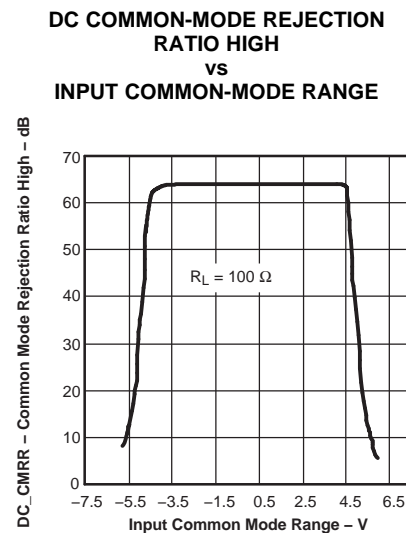

Figure 68.

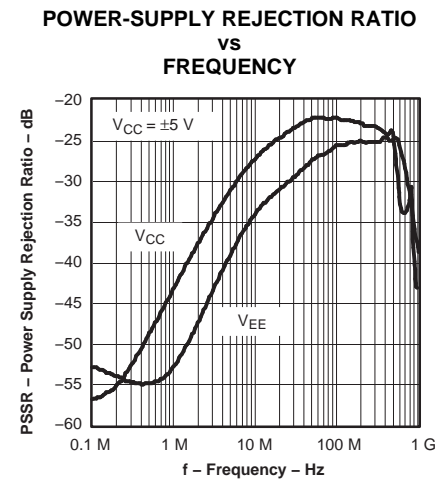

Figure 69.

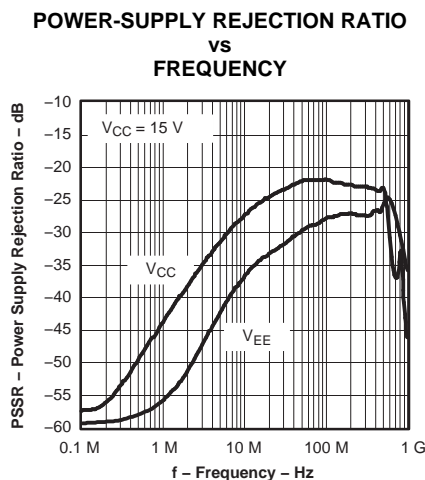

Figure 70.

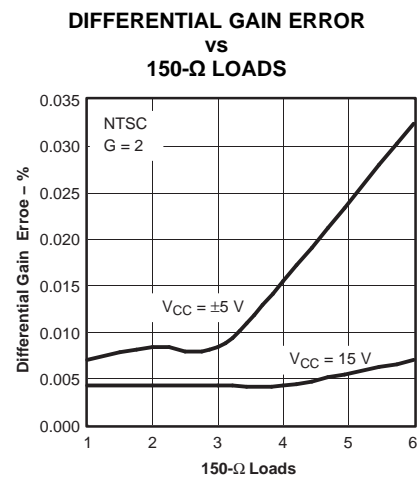

Figure 71.

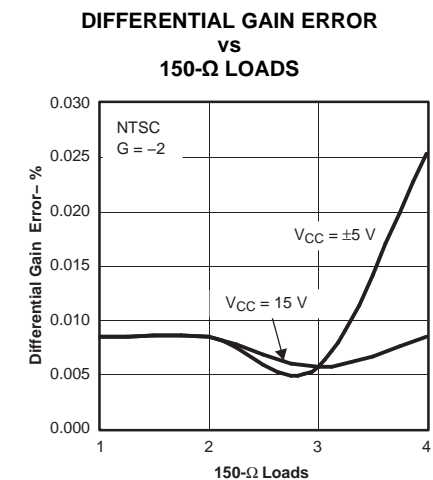
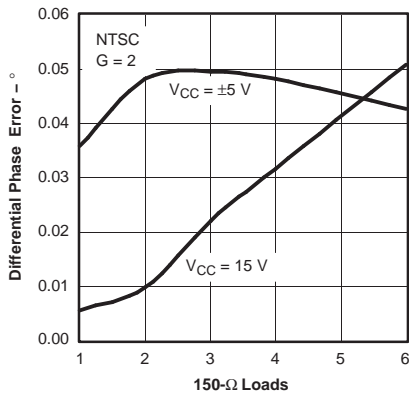

Figure 72.

**TYPICAL CHARACTERISTICS (continued)**

**DIFFERENTIAL PHASE ERROR  
vs  
150-Ω LOADS**



**Figure 73.**

**DIFFERENTIAL PHASE ERROR  
vs  
150-Ω LOADS**

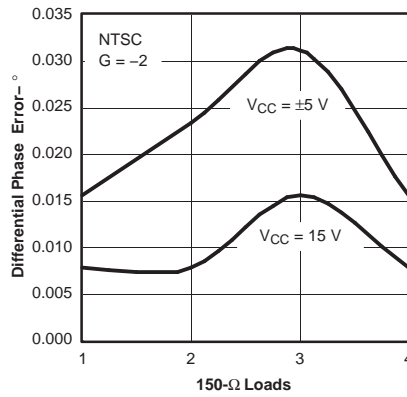

**Figure 74.**

**DIFFERENTIAL GAIN ERROR  
vs  
150-Ω LOADS**

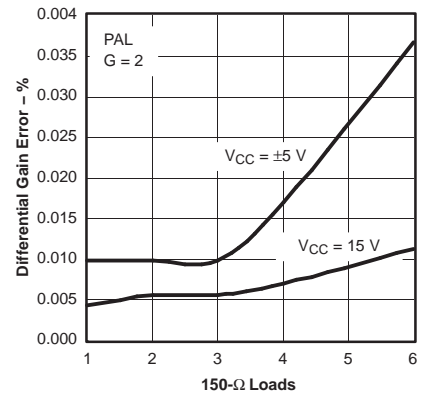

**Figure 75.**

**DIFFERENTIAL PHASE ERROR  
vs  
150-Ω LOADS**

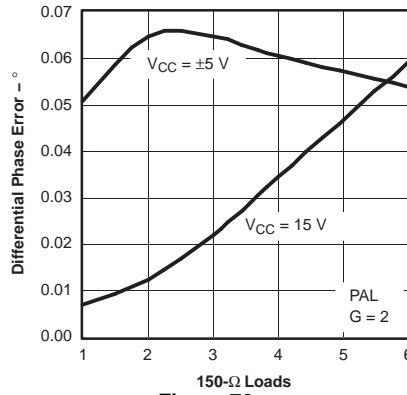

**Figure 76.**

## APPLICATION INFORMATION

### INTRODUCTION

The THS3202 is a high-speed, operational amplifier configured in a current-feedback architecture. The device is built using Texas Instruments BiCOM-II process, a 15-V, dielectrically isolated, complementary bipolar process with NPN and PNP transistors possessing  $f_T$ s of several GHz. This configuration implements an exceptionally high-performance amplifier that has a wide bandwidth, high slew rate, fast settling time, and low distortion.

### RECOMMENDED FEEDBACK AND GAIN RESISTOR VALUES

As with all current-feedback amplifiers, the bandwidth of the THS3202 is an inversely proportional function of the value of the feedback resistor. The recommended resistors for the optimum frequency response are shown in [Table 1](#). These should be used as a starting point and once optimum values are found, 1% tolerance resistors should be used to maintain frequency response characteristics. For most applications, a feedback resistor value of 750  $\Omega$  is recommended—a good compromise between bandwidth and phase margin that yields a very stable amplifier.

**Table 1. Recommended Resistor Values for Optimum Frequency Response**

THS3202 R <sub>F</sub> FOR AC WHEN R <sub>LOAD</sub> = 100 $\Omega$			
GAIN	V <sub>SUP</sub>	PEAKING	R <sub>F</sub> VALUE
1	15	Optimum	619
	±5	Optimum	619
2	15	Optimum	536
	±5	Optimum	536
5	15	Optimum	402
	±5	Optimum	402
10	15	Optimum	200
	±5	Optimum	200
-1	15	Optimum	450
	±5	Optimum	450

As shown in [Table 1](#), to maintain the highest bandwidth with an increasing gain, the feedback resistor is reduced. The advantage of dropping the feedback resistor (and the gain resistor) is that the noise of the system is also reduced compared to no reduction of these resistor values (see the [Noise Calculations](#) section). Thus, keeping the bandwidth as high as possible maintains very good distortion performance of the amplifier by keeping the excess loop gain as high as possible.

Care must be taken to not drop these values too low. The amplifier output must drive the feedback resistance (and gain resistance) and may place a burden on the amplifier. The end result is that distortion may actually increase due to the low impedance load presented to the amplifier. Careful management of the amplifier bandwidth and the associated loading effects must be examined by the designer for optimum performance.

The THS3202 amplifier exhibits very good distortion performance and bandwidth with the capability of utilizing up to 15-V supplies. Their excellent current drive capability of up to 115 mA driving into a 20-Ω load allows for many versatile applications. One application is driving a twisted pair line (for example, a telephone line). Figure 77 shows a simple circuit for driving a twisted pair differentially.

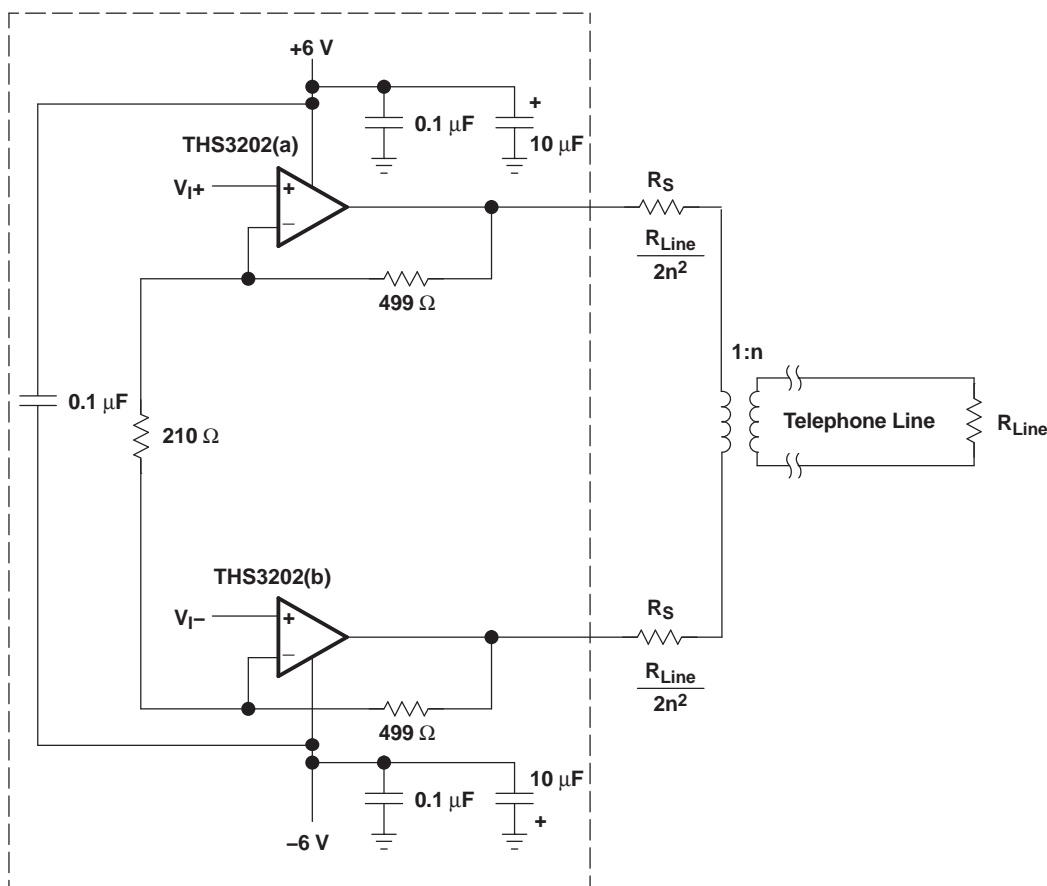

Figure 77. Simple Line Driver With THS3202

Due to the large power-supply voltages and the large current drive capability, power dissipation of the amplifier must not be neglected. To have as much power dissipation as possible in a small package, the THS3202 is available in an MSOP-8 package (DGK), an MSOP-8 PowerPAD package (DGN), and an SOIC-8 package (D). Again, power dissipation of the amplifier must be carefully examined or else the amplifiers could become too hot and performance can be severely degraded. See the [Power Dissipation and Thermal Considerations](#) section for more information on thermal management.

## NOISE CALCULATIONS

Noise can cause errors on very small signals. This is especially true for amplifying small signals coming over a transmission line or an antenna. The noise model for current-feedback amplifiers (CFB) is the same as for voltage feedback amplifiers (VFB). The only difference between the two is that CFB amplifiers generally specify different current-noise parameters for each input, while VFB amplifiers usually only specify one noise-current parameter. The noise model is shown in Figure 78. This model includes all of the noise sources as follows:

- $e_n$  = Amplifier internal voltage noise ( $\text{nV}/\sqrt{\text{Hz}}$ )
- $IN+$  = Noninverting current noise ( $\text{pA}/\sqrt{\text{Hz}}$ )
- $IN-$  = Inverting current noise ( $\text{pA}/\sqrt{\text{Hz}}$ )
- $e_{R_x}$  = Thermal voltage noise associated with each resistor ( $e_{R_x} = 4 \text{ kTR}_x$ )

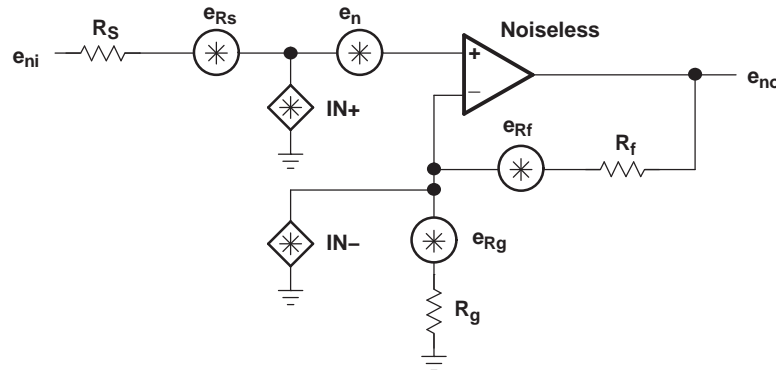

**Figure 78. Noise Model**

The total equivalent input noise density ( $e_{ni}$ ) is calculated by using the following equation:

$$e_{ni} = \sqrt{(e_n)^2 + (IN+ \times R_S)^2 + (IN- \times (R_f \parallel R_g))^2 + 4 \text{ kTR}_S + 4 \text{ kT}(R_f \parallel R_g)}$$

where:

$k$  = Boltzmann's constant =  $1.380658 \times 10^{-23}$

$T$  = Temperature in degrees Kelvin ( $273 + ^\circ\text{C}$ )

$R_f \parallel R_g$  = Parallel resistance of  $R_f$  and  $R_g$

To get the equivalent output noise of the amplifier, multiply the equivalent input noise density ( $e_{ni}$ ) by the overall amplifier gain ( $A_V$ ).

$$e_{no} = e_{ni} A_V = e_{ni} \left( 1 + \frac{R_f}{R_g} \right) \text{ (Noninverting Case)}$$

As the previous equations show, to keep noise at a minimum, small value resistors should be used. As the closed-loop gain is increased (by reducing  $R_f$  and  $R_g$ ), the input noise is reduced considerably because of the parallel resistance term. This leads to the general conclusion that the most dominant noise sources are the source resistor ( $R_S$ ) and the internal amplifier noise voltage ( $e_n$ ). Because noise is summed in a root-mean-squares method, noise sources smaller than 25% of the largest noise source can be effectively ignored. This can greatly simplify the formula and make noise calculations much easier.

This brings up another noise measurement usually preferred in RF applications, the noise figure (NF). Noise figure is a measure of noise degradation caused by the amplifier. The value of the source resistance must be defined and is typically 50  $\Omega$  in RF applications.

$$NF = 10 \log \left[ \frac{e_{ni}^2}{e_{Rs}^2} \right]$$

Because the dominant noise components are generally the source resistance and the internal amplifier noise voltage, we can approximate the noise figure as:

$$NF = 10 \log \left[ 1 + \frac{\left[ (e_n)^2 + (IN + \times R_S)^2 \right]}{4 kTR_S} \right]$$

## PRINTED-CIRCUIT BOARD LAYOUT TECHNIQUES FOR OPTIMAL PERFORMANCE

Achieving optimum performance with high-frequency amplifier-like devices in the THS320x family requires careful attention to board layout parasitic and external component types.

Recommendations that optimize performance include:

- Minimize parasitic capacitance to any ac ground for all of the signal I/O pins. Parasitic capacitance on the output and input pins can cause instability. To reduce unwanted capacitance, a window around the signal I/O pins should be opened in all of the ground and power planes around those pins. Otherwise, ground and power planes should be unbroken elsewhere on the board.
- Minimize the distance (< 0.25" or < 6,35 mm) from the power-supply pins to high-frequency 0.1- $\mu$ F and 100 pF decoupling capacitors. At the device pins, the ground and power-plane layout should not be in close proximity to the signal I/O pins. Avoid narrow power and ground traces to minimize inductance between the pins and the decoupling capacitors. The power-supply connections should always be decoupled with these capacitors. Larger (6.8  $\mu$ F or more) tantalum decoupling capacitors, effective at lower frequency, should also be used on the main supply pins. These may be placed somewhat farther from the device and may be shared among several devices in the same area of the printed circuit board (PCB). The primary goal is to minimize the impedance seen in the differential-current return paths. For driving differential loads with the THS3202, adding a capacitor between the power-supply pins improves 2nd order harmonic distortion performance. This also minimizes the current loop formed by the differential drive.
- Careful selection and placement of external components preserve the high-frequency performance of the THS320x family. Resistors should be a very low reactance type. Surface-mount resistors work best and allow a tighter overall layout. Again, keep their leads and PCB trace length as short as possible. Never use wirewound type resistors in a high-frequency application. Because the output pin and inverting input pins are the most sensitive to parasitic capacitance, always position the feedback and series output resistors, if any, as close as possible to the inverting input pins and output pins. Other network components, such as input termination resistors, should be placed close to the gain-setting resistors. Even with a low parasitic capacitance shunting the external resistors, excessively high resistor values can create significant time constants that can degrade performance. Good axial metal-film or surface-mount resistors have approximately 0.2 pF in shunt with the resistor. For resistor values greater than 2.0 k $\Omega$ , this parasitic capacitance can add a pole and/or a zero that can affect circuit operation. Keep resistor values as low as possible, consistent with load driving considerations.
- Connections to other wideband devices on the board may be made with short direct traces or through onboard transmission lines. For short connections, consider the trace and the input to the next device as a lumped capacitive load. Relatively wide traces (50 mils to 100 mils or 1,27 mm to 2,54 mm) should be used, preferably with ground and power planes opened up around them. Estimate the total capacitive load and determine if isolation resistors on the outputs are necessary. Low parasitic capacitive loads (less than 4 pF) may not need an  $R_S$  because the THS320x family is nominally compensated to operate with a 2-pF parasitic load. Higher parasitic capacitive loads without an  $R_S$  are allowed as the signal gain increases (increasing the unloaded phase margin). If a long trace is required, and the 6-dB signal loss intrinsic to a doubly-terminated

transmission line is acceptable, implement a matched impedance transmission line using microstrip or stripline techniques (consult an ECL design handbook for microstrip and stripline layout techniques).

A 50-Ω environment is not necessary onboard, and in fact, a higher impedance environment improves distortion as shown in the distortion versus load plots. With a characteristic board trace impedance based on board material and trace dimensions, a matching series resistor into the trace from the output of the THS320x is used as well as a terminating shunt resistor at the input of the destination device.

Remember also that the terminating impedance is the parallel combination of the shunt resistor and the input impedance of the destination device: this total effective impedance should be set to match the trace impedance. If the 6-dB attenuation of a doubly-terminated transmission line is unacceptable, a long trace can be series-terminated at the source end only. Treat the trace as a capacitive load in this case. This does not preserve signal integrity as well as a doubly-terminated line. If the input impedance of the destination device is low, there is some signal attenuation due to the voltage divider formed by the series output into the terminating impedance.

- Socketing a high-speed part like the THS320x family is not recommended. The additional lead length and pin-to-pin capacitance introduced by the socket can create an extremely troublesome parasitic network which can make it almost impossible to achieve a smooth, stable frequency response. Best results are obtained by soldering the THS320x family devices directly onto the board.

## PowerPAD DESIGN CONSIDERATIONS

The THS320x family is available in a thermally-enhanced PowerPAD family of packages. These packages are constructed using a downset leadframe upon which the die is mounted [see [Figure 79\(a\)](#) and [Figure 79\(b\)](#)]. This arrangement results in the lead frame being exposed as a thermal pad on the underside of the package [see [Figure 79\(c\)](#)]. Because this thermal pad has direct thermal contact with the die, excellent thermal performance can be achieved by providing a good thermal path away from the thermal pad.

The PowerPAD package allows for both assembly and thermal management in one manufacturing operation. During the surface-mount solder operation (when the leads are being soldered), the thermal pad can also be soldered to a copper area underneath the package. Through the use of thermal paths within this copper area, heat can be conducted away from the package into either a ground plane or other heat dissipating device.

The PowerPAD package represents a breakthrough in combining the small area and ease of assembly of surface mount with the, heretofore, awkward mechanical methods of heatsinking.

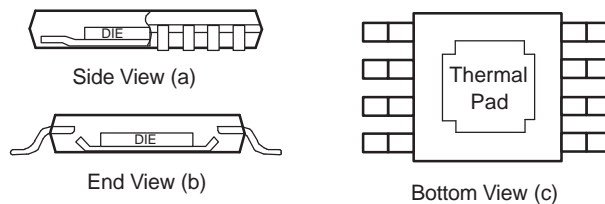
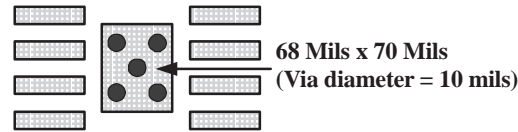

**Figure 79. Views of Thermally-Enhanced Package**

Although there are many ways to properly heatsink the PowerPAD package, the following steps illustrate the recommended approach.

## PowerPAD PCB LAYOUT CONSIDERATIONS

1. Prepare the PCB with a top side etch pattern as shown in [Figure 80](#). There should be etch for the leads as well as etch for the thermal pad.



**Figure 80. DGN PowerPAD PCB Etch and Via Pattern**

2. Place five holes in the area of the thermal pad. These holes should be 10 mils (0,254 mm) in diameter. Keep them small so that solder wicking through the holes is not a problem during reflow.
3. Additional vias may be placed anywhere along the thermal plane outside of the thermal pad area. This helps dissipate the heat generated by the THS320x family IC. These additional vias may be larger than the 10-mil diameter vias directly under the thermal pad. They can be larger because they are not in the thermal pad area to be soldered so that wicking is not a problem.
4. Connect all holes to the internal ground plane.
5. When connecting these holes to the ground plane, **do not** use the typical web or spoke via connection methodology. Web connections have a high thermal resistance connection that is useful for slowing the heat transfer during soldering operations. This makes the soldering of vias that have plane connections easier. In this application, however, low thermal resistance is desired for the most efficient heat transfer. Therefore, the holes under the THS320x family PowerPAD package should make their connection to the internal ground plane with a complete connection around the entire circumference of the plated-through hole.
6. The top-side solder mask should leave the terminals of the package and the thermal pad area with its five holes exposed. The bottom-side solder mask should cover the five holes of the thermal pad area. This prevents solder from being pulled away from the thermal pad area during the reflow process.
7. Apply solder paste to the exposed thermal pad area and all of the IC terminals.
8. With these preparatory steps in place, the IC is simply placed in position and run through the solder reflow operation as any standard surface-mount component. This results in a part that is properly installed.

## POWER DISSIPATION AND THERMAL CONSIDERATIONS

To maintain maximum output capabilities, the THS3202 does not incorporate automatic thermal shutoff protection. The designer must take care to ensure that the design does not violate the absolute maximum junction temperature of the device. Failure may result if the absolute maximum junction temperature of +150°C is exceeded. For best performance, design for a maximum junction temperature of +125°C. Between +125°C and +150°C, damage does not occur, but the performance of the amplifier begins to degrade.

The thermal characteristics of the device are dictated by the package and the PCB. Maximum power dissipation for a given package can be calculated using the following formula.

$$P_{Dmax} = \frac{T_{max} - T_A}{\theta_{JA}}$$

where:

$P_{Dmax}$  is the maximum power dissipation in the amplifier (W).

$T_{max}$  is the absolute maximum junction temperature (°C).

$T_A$  is the ambient temperature (°C).

$\theta_{JA} = \theta_{JC} + \theta_{CA}$

$\theta_{JC}$  is the thermal coefficient from the silicon junctions to the case (°C/W).

$\theta_{CA}$  is the thermal coefficient from the case to ambient air (°C/W).

For systems where heat dissipation is more critical, the THS320x family of devices is offered in an MSOP-8 with PowerPAD. The thermal coefficient for the PowerPAD packages are substantially improved over the traditional SOIC. Maximum power dissipation levels are depicted in the graph for the available packages. The data for the PowerPAD packages assume a board layout that follows the PowerPAD layout guidelines referenced above and detailed in the PowerPAD application note number [SLMA002](#). The following graph also illustrates the effect of not soldering the PowerPAD to a PCB. The thermal impedance increases substantially which may cause serious heat and performance issues. Be sure to always solder the PowerPAD to the PCB for optimum performance.

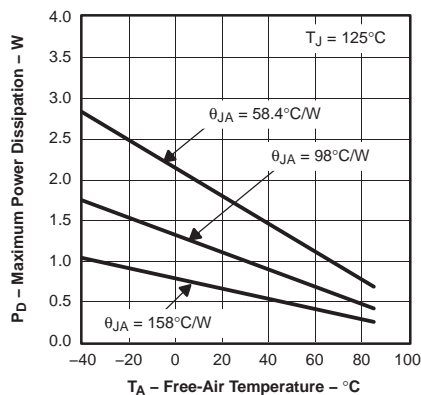

Results are With No Air Flow and PCB Size = 3"x3"  
 $\theta_{JA} = 58.4^\circ\text{C/W}$  for 8-Pin MSOP w/PowerPad (DGN)  
 $\theta_{JA} = 98^\circ\text{C/W}$  for 8-Pin SOIC High Test PCB (D)  
 $\theta_{JA} = 158^\circ\text{C/W}$  for 8-Pin MSOP w/PowerPad w/o Solder

Figure 81. Maximum Power Dissipation vs Ambient Temperature

When determining whether or not the device satisfies the maximum power dissipation requirement, it is important to not only consider quiescent power dissipation, but also dynamic power dissipation. Often times, this is difficult to quantify because the signal pattern is inconsistent, but an estimate of the RMS power dissipation can provide visibility into a possible problem.

### DRIVING A CAPACITIVE LOAD

Driving capacitive loads with high-performance amplifiers is not a problem as long as certain precautions are taken. The first is to realize that the THS3202 has been internally compensated to maximize its bandwidth and slew-rate performance. When the amplifier is compensated in this manner, capacitive loading directly on the output decreases the device's phase margin leading to high-frequency ringing or oscillations. Therefore, for capacitive loads of greater than 10 pF, it is recommended that a resistor be placed in series with the output of the amplifier, as shown in [Figure 82](#). A minimum value of 10  $\Omega$  should work well for most applications. For example, in 75- $\Omega$  transmission systems, setting the series resistor value to 75  $\Omega$  both isolates any capacitance loading and provides the proper line impedance matching at the source end.

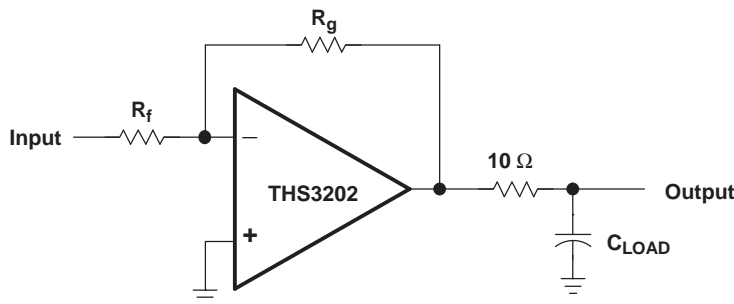
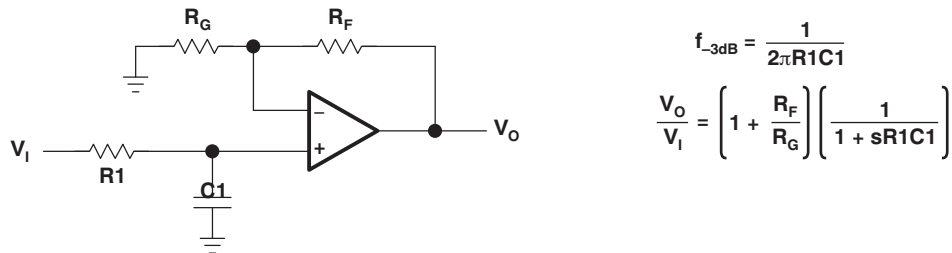

Figure 82. Driving a Capacitive Load

## GENERAL CONFIGURATIONS

A common error for the first-time CFB user is creating a unity-gain buffer amplifier by shorting the output directly to the inverting input. A CFB amplifier in this configuration oscillates and is *not* recommended. The THS3202, like all CFB amplifiers, *must* have a feedback resistor for stable operation. Additionally, placing capacitors directly from the output to the inverting input is not recommended. This is because, at high frequencies, a capacitor has a very low impedance. This results in an unstable amplifier and should not be considered when using a current-feedback amplifier. Because of this, integrators and simple low-pass filters, which are easily implemented on a VFB amplifier, have to be designed slightly differently. If filtering is required, simply place an RC-filter at the noninverting terminal of the operational amplifier, as shown in [Figure 83](#).



**Figure 83. Single-Pole Low-Pass Filter**

If a multiple-pole filter is required, the use of a Sallen-Key filter can work very well with CFB amplifiers. This is because the filtering elements are not in the negative feedback loop and stability is not compromised. Because of their high slew-rates and high bandwidths, CFB amplifiers can create very accurate signals and help minimize distortion. An example is shown in [Figure 84](#).

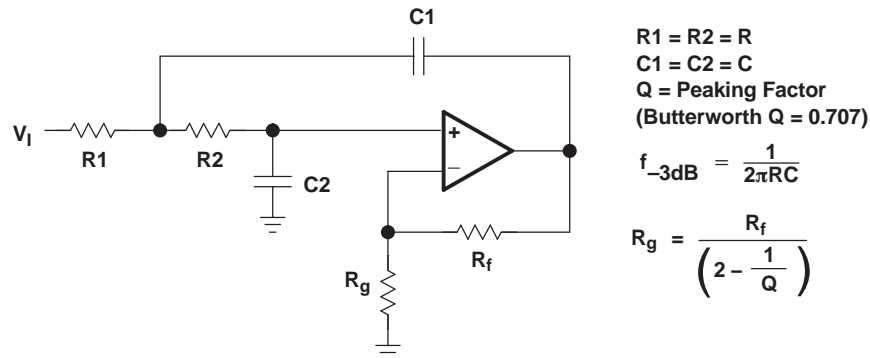

**Figure 84. 2-Pole Low-Pass Sallen-Key Filter**

There are two simple ways to create an integrator with a CFB amplifier. The first, shown in [Figure 85](#), adds a resistor in series with the capacitor. This is acceptable because at high frequencies, the resistor is dominant and the feedback impedance never drops below the resistor value. The second, shown in [Figure 86](#), uses positive feedback to create the integration. Caution is advised because oscillations can occur due to the positive feedback.

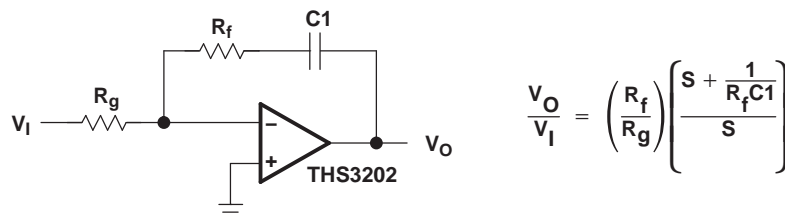

**Figure 85. Inverting CFB Integrator**

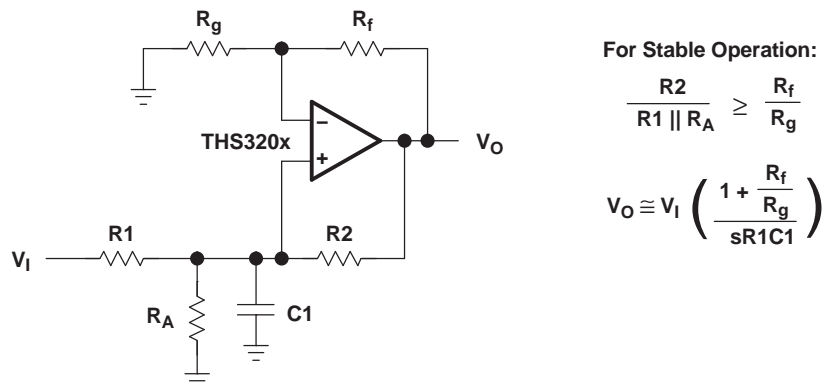

Figure 86. Noninverting CFB Integrator

The THS3202 may also be employed as a very good video distribution amplifier. One characteristic of distribution amplifiers is the fact that the differential phase (DP) and the differential gain (DG) are compromised as the number of lines increase and the closed-loop gain increases. Be sure to use termination resistors throughout the distribution system to minimize reflections and capacitive loading.

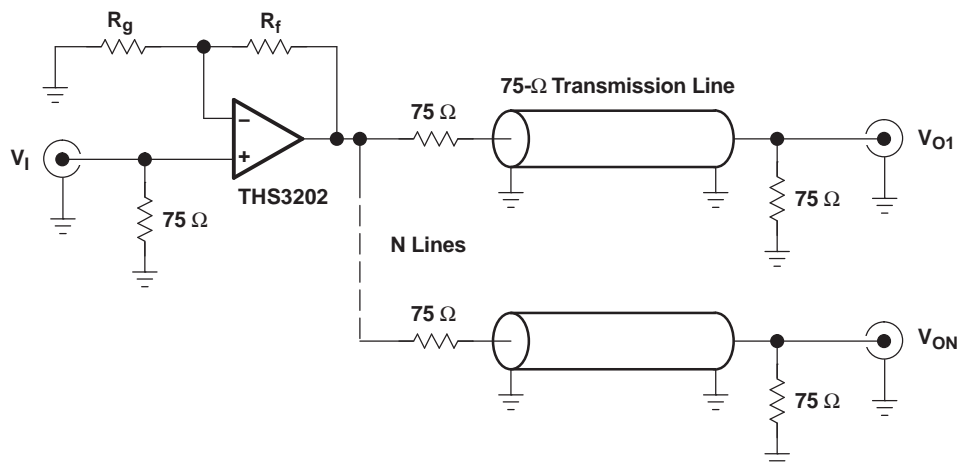

Figure 87. Video Distribution Amplifier Application

## REVISION HISTORY

NOTE: Page numbers for previous revisions may differ from page numbers in the current version.

Changes from Revision E (April 2009) to Revision F	Page
• Updated document format to current standards .....	1
• Deleted <i>lead temperature</i> specification from Absolute Maximum Ratings table .....	2
• Changed first sentence of third paragraph of <i>Power Dissipation and Thermal Considerations</i> section .....	23

Changes from Revision D (January 2009) to Revision E	Page
• Deleted feature bullets relating to IMD3 and OIP3 at $V_{CC} = 15\text{ V}$ .....	1
• Replaced figures .....	1
• Changed text in first sentence of <i>Description</i> section .....	1
• Deleted harmonic distortion specifications in <i>AC Performance</i> subsection for $V_{CC} = 15\text{ V}$ .....	6
• Deleted harmonic distortion graphs for $V_{CC} = 15\text{ V}$ .....	10

**PACKAGING INFORMATION**

Orderable Device	Status (1)	Package Type	Package Drawing	Pins	Package Qty	Eco Plan (2)	Lead/Ball Finish (6)	MSL Peak Temp (3)	Op Temp (°C)	Device Marking (4/5)	Samples
THS3202D	NRND	SOIC	D	8	75	Green (RoHS & no Sb/Br)	CU NIPDAU	Level-1-260C-UNLIM	-40 to 85	3202	
THS3202DGK	NRND	VSSOP	DGK	8	80	Green (RoHS & no Sb/Br)	CU NIPDAU	Level-1-260C-UNLIM	-40 to 85	BEV	
THS3202DGKG4	NRND	VSSOP	DGK	8	80	Green (RoHS & no Sb/Br)	CU NIPDAU	Level-1-260C-UNLIM	-40 to 85	BEV	
THS3202DGN	NRND	MSOP- PowerPAD	DGN	8	80	Green (RoHS & no Sb/Br)	CU NIPDAU   CU NIPDAUAG	Level-1-260C-UNLIM	-40 to 85	BEP	
THS3202DGNG4	NRND	MSOP- PowerPAD	DGN	8	80	Green (RoHS & no Sb/Br)	CU NIPDAUAG	Level-1-260C-UNLIM	-40 to 85	BEP	
THS3202DGNR	NRND	MSOP- PowerPAD	DGN	8	2500	Green (RoHS & no Sb/Br)	CU NIPDAU   CU NIPDAUAG	Level-1-260C-UNLIM	-40 to 85	BEP	
THS3202DGNRG4	NRND	MSOP- PowerPAD	DGN	8	2500	Green (RoHS & no Sb/Br)	CU NIPDAUAG	Level-1-260C-UNLIM	-40 to 85	BEP	

(1) The marketing status values are defined as follows:

**ACTIVE:** Product device recommended for new designs.

**LIFEBUY:** TI has announced that the device will be discontinued, and a lifetime-buy period is in effect.

**NRND:** Not recommended for new designs. Device is in production to support existing customers, but TI does not recommend using this part in a new design.

**PREVIEW:** Device has been announced but is not in production. Samples may or may not be available.

**OBSOLETE:** TI has discontinued the production of the device.

(2) **RoHS:** TI defines "RoHS" to mean semiconductor products that are compliant with the current EU RoHS requirements for all 10 RoHS substances, including the requirement that RoHS substance do not exceed 0.1% by weight in homogeneous materials. Where designed to be soldered at high temperatures, "RoHS" products are suitable for use in specified lead-free processes. TI may reference these types of products as "Pb-Free".

**RoHS Exempt:** TI defines "RoHS Exempt" to mean products that contain lead but are compliant with EU RoHS pursuant to a specific EU RoHS exemption.

**Green:** TI defines "Green" to mean the content of Chlorine (Cl) and Bromine (Br) based flame retardants meet JS709B low halogen requirements of <=100ppm threshold. Antimony trioxide based flame retardants must also meet the <=1000ppm threshold requirement.

(3) MSL, Peak Temp. - The Moisture Sensitivity Level rating according to the JEDEC industry standard classifications, and peak solder temperature.

(4) There may be additional marking, which relates to the logo, the lot trace code information, or the environmental category on the device.

(5) Multiple Device Markings will be inside parentheses. Only one Device Marking contained in parentheses and separated by a "-" will appear on a device. If a line is indented then it is a continuation of the previous line and the two combined represent the entire Device Marking for that device.

<sup>(6)</sup> Lead/Ball Finish - Orderable Devices may have multiple material finish options. Finish options are separated by a vertical ruled line. Lead/Ball Finish values may wrap to two lines if the finish value exceeds the maximum column width.

**Important Information and Disclaimer:** The information provided on this page represents TI's knowledge and belief as of the date that it is provided. TI bases its knowledge and belief on information provided by third parties, and makes no representation or warranty as to the accuracy of such information. Efforts are underway to better integrate information from third parties. TI has taken and continues to take reasonable steps to provide representative and accurate information but may not have conducted destructive testing or chemical analysis on incoming materials and chemicals. TI and TI suppliers consider certain information to be proprietary, and thus CAS numbers and other limited information may not be available for release.

In no event shall TI's liability arising out of such information exceed the total purchase price of the TI part(s) at issue in this document sold by TI to Customer on an annual basis.

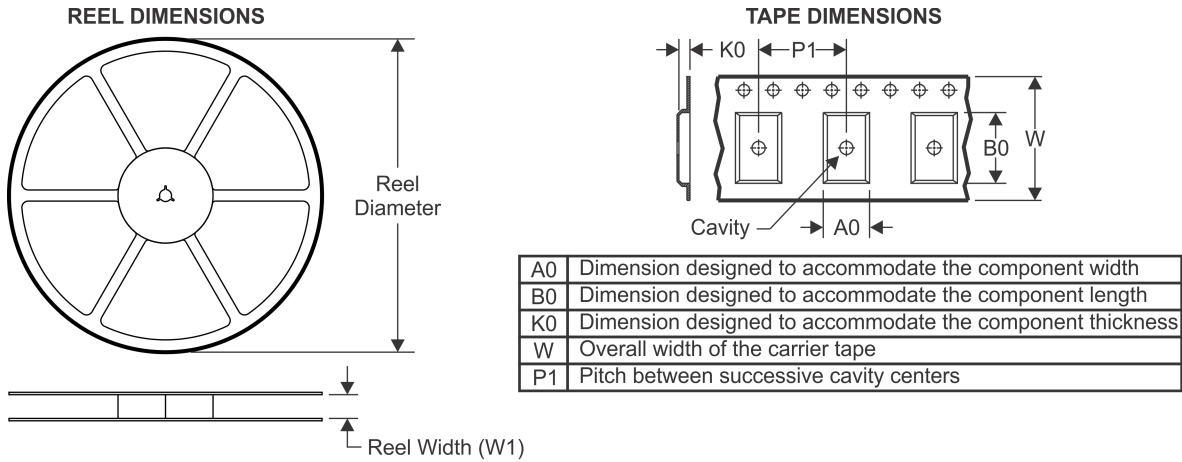
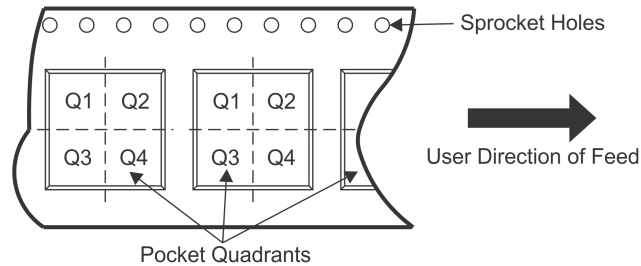
**TAPE AND REEL INFORMATION**

**QUADRANT ASSIGNMENTS FOR PIN 1 ORIENTATION IN TAPE**

\*All dimensions are nominal

Device	Package Type	Package Drawing	Pins	SPQ	Reel Diameter (mm)	Reel Width W1 (mm)	A0 (mm)	B0 (mm)	K0 (mm)	P1 (mm)	W (mm)	Pin1 Quadrant
THS3202DGNR	MSOP-Power PAD	DGN	8	2500	330.0	12.4	5.3	3.4	1.4	8.0	12.0	Q1

TAPE AND REEL BOX DIMENSIONS



\*All dimensions are nominal

Device	Package Type	Package Drawing	Pins	SPQ	Length (mm)	Width (mm)	Height (mm)
THS3202DGNR	MSOP-PowerPAD	DGN	8	2500	364.0	364.0	27.0



D0008A

# PACKAGE OUTLINE

SOIC - 1.75 mm max height

SMALL OUTLINE INTEGRATED CIRCUIT



4214825/C 02/2019

NOTES:

1. Linear dimensions are in inches [millimeters]. Dimensions in parenthesis are for reference only. Controlling dimensions are in inches. Dimensioning and tolerancing per ASME Y14.5M.
2. This drawing is subject to change without notice.
3. This dimension does not include mold flash, protrusions, or gate burrs. Mold flash, protrusions, or gate burrs shall not exceed  $.006$  [0.15] per side.
4. This dimension does not include interlead flash.
5. Reference JEDEC registration MS-012, variation AA.

# EXAMPLE BOARD LAYOUT

D0008A

SOIC - 1.75 mm max height

SMALL OUTLINE INTEGRATED CIRCUIT



LAND PATTERN EXAMPLE  
 EXPOSED METAL SHOWN  
 SCALE:8X



SOLDER MASK DETAILS

4214825/C 02/2019

NOTES: (continued)

- 6. Publication IPC-7351 may have alternate designs.
- 7. Solder mask tolerances between and around signal pads can vary based on board fabrication site.

# EXAMPLE STENCIL DESIGN

D0008A

SOIC - 1.75 mm max height

SMALL OUTLINE INTEGRATED CIRCUIT



SOLDER PASTE EXAMPLE  
BASED ON .005 INCH [0.125 MM] THICK STENCIL  
SCALE:8X

4214825/C 02/2019

NOTES: (continued)

8. Laser cutting apertures with trapezoidal walls and rounded corners may offer better paste release. IPC-7525 may have alternate design recommendations.
9. Board assembly site may have different recommendations for stencil design.

DGK (S-PDSO-G8)

PLASTIC SMALL-OUTLINE PACKAGE

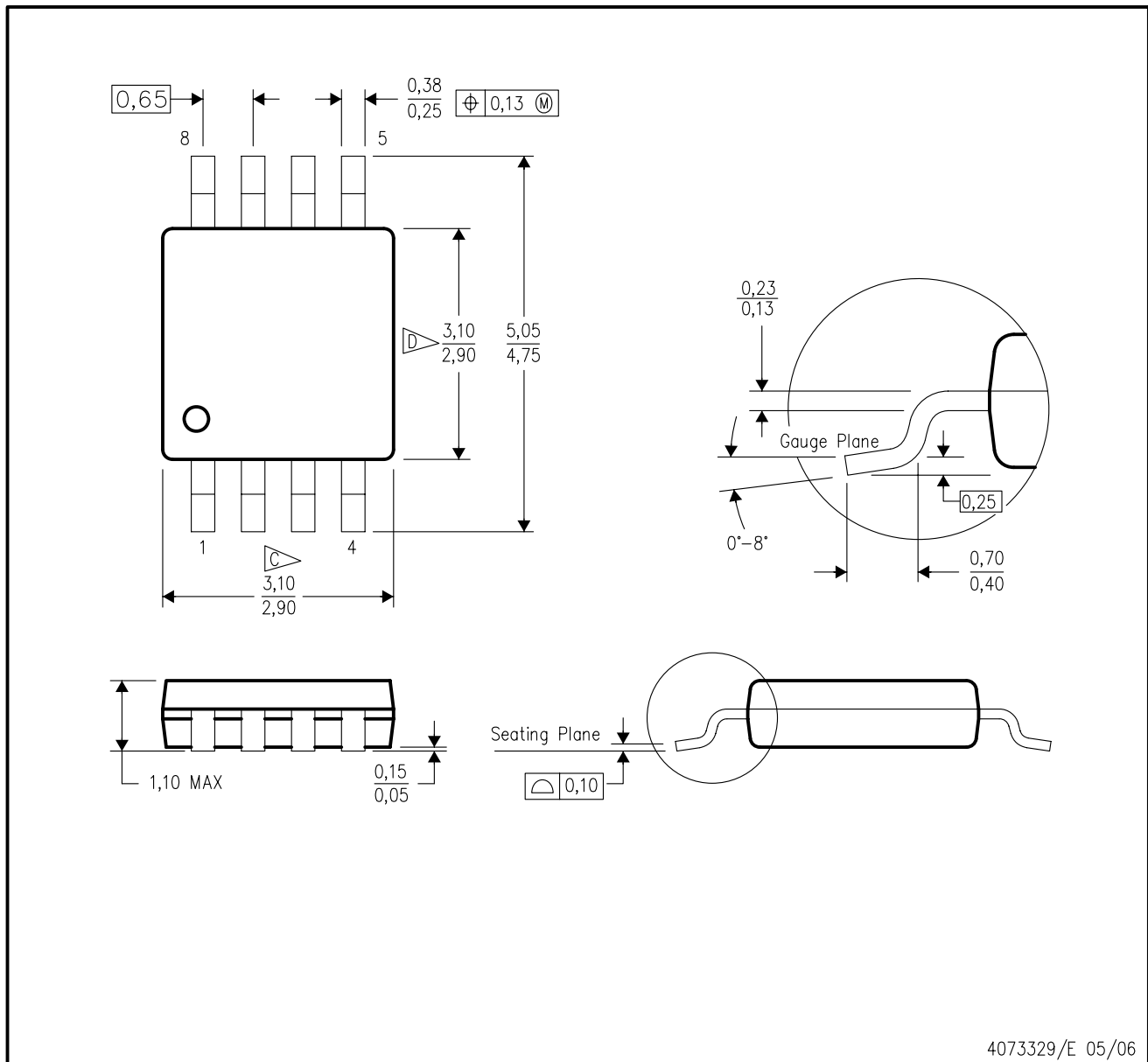

4073329/E 05/06

- NOTES:
- A. All linear dimensions are in millimeters.
  - B. This drawing is subject to change without notice.
  - C. Body length does not include mold flash, protrusions, or gate burrs. Mold flash, protrusions, or gate burrs shall not exceed 0.15 per end.
  - D. Body width does not include interlead flash. Interlead flash shall not exceed 0.50 per side.
  - E. Falls within JEDEC MO-187 variation AA, except interlead flash.



- NOTES:
- All linear dimensions are in millimeters.
  - This drawing is subject to change without notice.
  - Publication IPC-7351 is recommended for alternate designs.
  - Laser cutting apertures with trapezoidal walls and also rounding corners will offer better paste release. Customers should contact their board assembly site for stencil design recommendations. Refer to IPC-7525 for other stencil recommendations.
  - Customers should contact their board fabrication site for solder mask tolerances between and around signal pads.

DGN (S-PDSO-G8)

PowerPAD™ PLASTIC SMALL OUTLINE

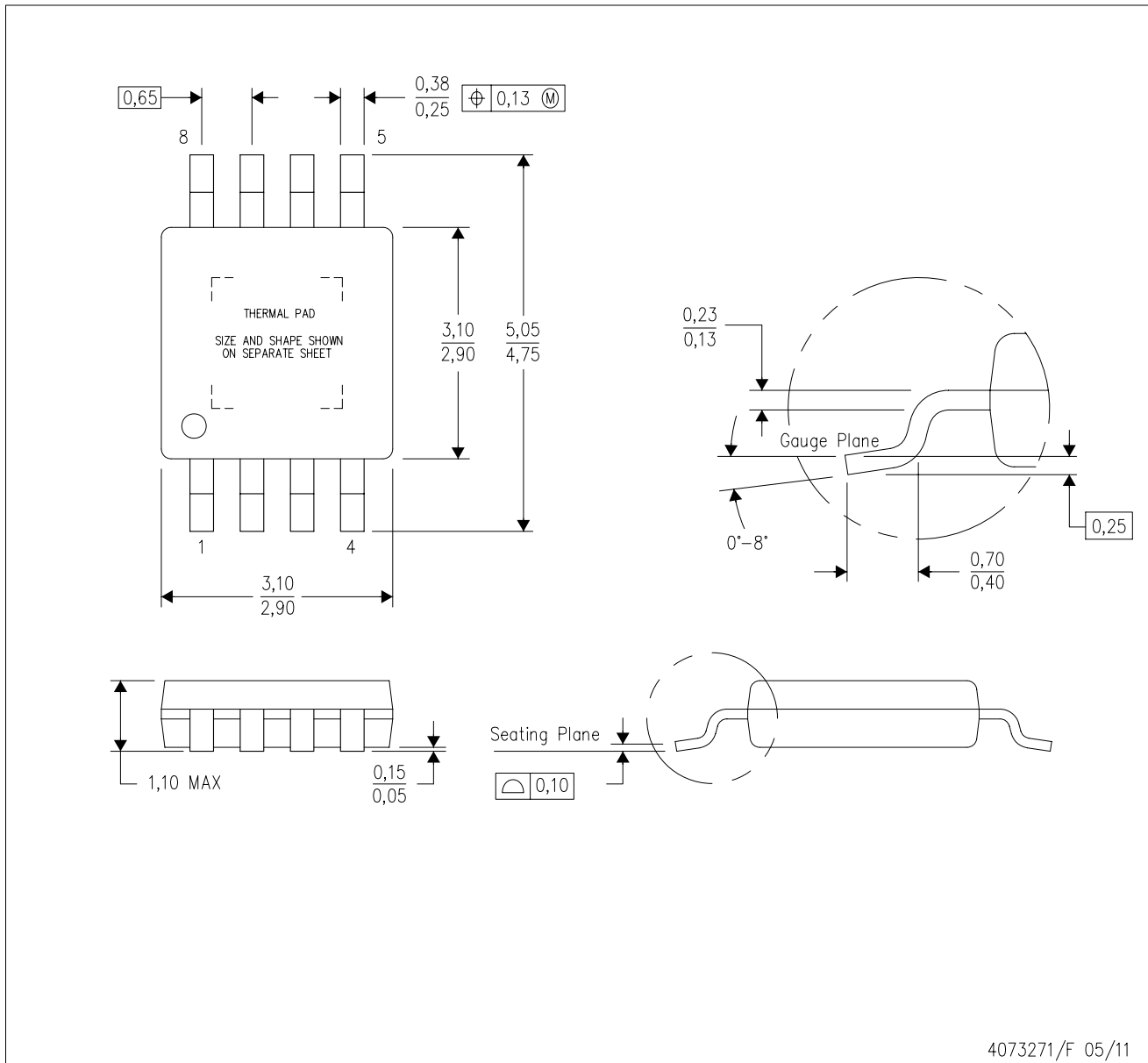

- NOTES:
- All linear dimensions are in millimeters.
  - This drawing is subject to change without notice.
  - Body dimensions do not include mold flash or protrusion.
  - This package is designed to be soldered to a thermal pad on the board. Refer to Technical Brief, PowerPad Thermally Enhanced Package, Texas Instruments Literature No. SLMA002 for information regarding recommended board layout. This document is available at [www.ti.com](http://www.ti.com) <<http://www.ti.com>>.
  - See the additional figure in the Product Data Sheet for details regarding the exposed thermal pad features and dimensions.
  - Falls within JEDEC MO-187 variation AA-T

PowerPAD is a trademark of Texas Instruments.

DGN (S-PDSO-G8)

PowerPAD™ PLASTIC SMALL OUTLINE

## THERMAL INFORMATION

This PowerPAD™ package incorporates an exposed thermal pad that is designed to be attached to a printed circuit board (PCB). The thermal pad must be soldered directly to the PCB. After soldering, the PCB can be used as a heatsink. In addition, through the use of thermal vias, the thermal pad can be attached directly to the appropriate copper plane shown in the electrical schematic for the device, or alternatively, can be attached to a special heatsink structure designed into the PCB. This design optimizes the heat transfer from the integrated circuit (IC).

For additional information on the PowerPAD package and how to take advantage of its heat dissipating abilities, refer to Technical Brief, PowerPAD Thermally Enhanced Package, Texas Instruments Literature No. SLMA002 and Application Brief, PowerPAD Made Easy, Texas Instruments Literature No. SLMA004. Both documents are available at [www.ti.com](http://www.ti.com).

The exposed thermal pad dimensions for this package are shown in the following illustration.

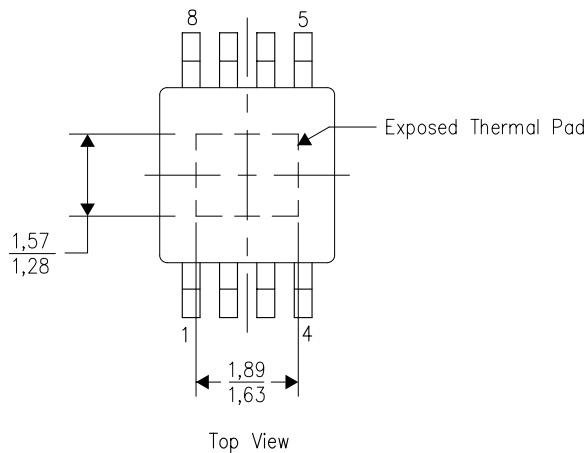

Exposed Thermal Pad Dimensions

4206323-2/1 12/11

NOTE: All linear dimensions are in millimeters

PowerPAD is a trademark of Texas Instruments

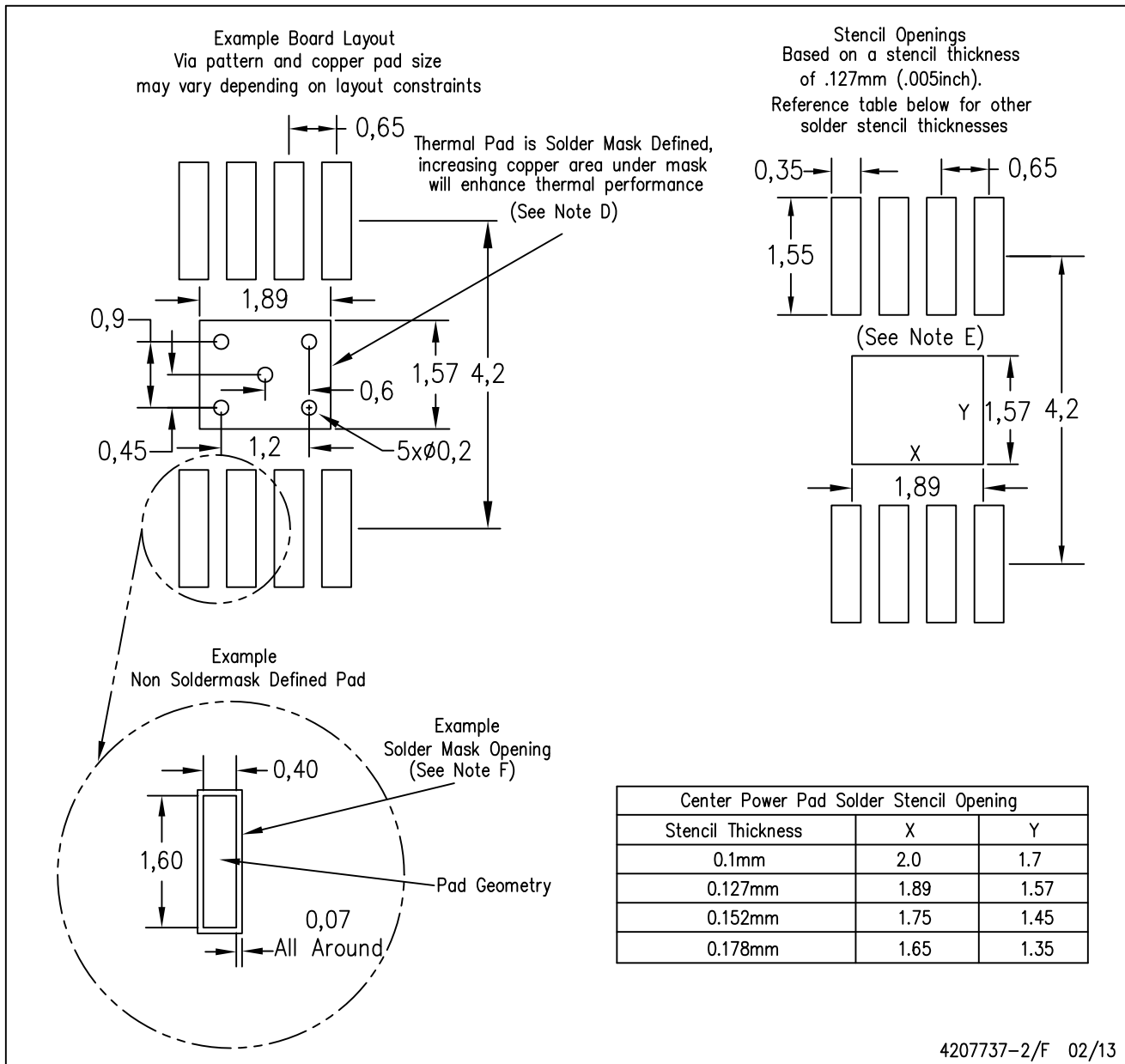

- NOTES:
- A. All linear dimensions are in millimeters.
  - B. This drawing is subject to change without notice.
  - C. Customers should place a note on the circuit board fabrication drawing not to alter the center solder mask defined pad.
  - D. This package is designed to be soldered to a thermal pad on the board. Refer to Technical Brief, PowerPad Thermally Enhanced Package, Texas Instruments Literature No. SLMA002, SLMA004, and also the Product Data Sheets for specific thermal information, via requirements, and recommended board layout. These documents are available at [www.ti.com](http://www.ti.com) <<http://www.ti.com>>.
  - E. Laser cutting apertures with trapezoidal walls and also rounding corners will offer better paste release. Customers should contact their board assembly site for stencil design recommendations. Example stencil design based on a 50% volumetric metal load solder paste. Refer to IPC-7525 for other stencil recommendations.
  - F. Customers should contact their board fabrication site for solder mask tolerances between and around signal pads.

PowerPAD is a trademark of Texas Instruments

## IMPORTANT NOTICE AND DISCLAIMER

TI PROVIDES TECHNICAL AND RELIABILITY DATA (INCLUDING DATASHEETS), DESIGN RESOURCES (INCLUDING REFERENCE DESIGNS), APPLICATION OR OTHER DESIGN ADVICE, WEB TOOLS, SAFETY INFORMATION, AND OTHER RESOURCES "AS IS" AND WITH ALL FAULTS, AND DISCLAIMS ALL WARRANTIES, EXPRESS AND IMPLIED, INCLUDING WITHOUT LIMITATION ANY IMPLIED WARRANTIES OF MERCHANTABILITY, FITNESS FOR A PARTICULAR PURPOSE OR NON-INFRINGEMENT OF THIRD PARTY INTELLECTUAL PROPERTY RIGHTS.

These resources are intended for skilled developers designing with TI products. You are solely responsible for (1) selecting the appropriate TI products for your application, (2) designing, validating and testing your application, and (3) ensuring your application meets applicable standards, and any other safety, security, or other requirements. These resources are subject to change without notice. TI grants you permission to use these resources only for development of an application that uses the TI products described in the resource. Other reproduction and display of these resources is prohibited. No license is granted to any other TI intellectual property right or to any third party intellectual property right. TI disclaims responsibility for, and you will fully indemnify TI and its representatives against, any claims, damages, costs, losses, and liabilities arising out of your use of these resources.

TI's products are provided subject to TI's Terms of Sale ([www.ti.com/legal/termsofsale.html](http://www.ti.com/legal/termsofsale.html)) or other applicable terms available either on [ti.com](http://ti.com) or provided in conjunction with such TI products. TI's provision of these resources does not expand or otherwise alter TI's applicable warranties or warranty disclaimers for TI products.

Mailing Address: Texas Instruments, Post Office Box 655303, Dallas, Texas 75265  
Copyright © 2019, Texas Instruments Incorporated

## Looking for pricing, stock, or lifecycle information?

Click below to explore more details on WIN SOURCE:

 [View THS3202DGNRG4](#) on WIN SOURCE

 [Texas Instruments](#) Information

## Optimize Your Supply Chain with WIN SOURCE Solutions

-  Global Sourcing Solution
-  Obsolete Management
-  Cost Control Management
-  Shortage Management
-  Alternative Solution
-  Excess Inventory Management