

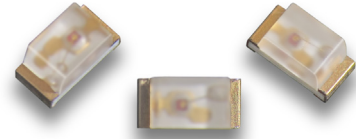

**THE DATASHEET OF
APT1608SGC**





APT1608SGC

1.6 x 0.8 mm SMD Chip LED Lamp

DESCRIPTION

- The Super Bright Green source color devices are made with Gallium Phosphide Green Light Emitting Diode

FEATURES

- 1.6 mm x 0.8 mm SMD LED, 0.75 mm thickness
- Low power consumption
- Wide viewing angle
- Ideal for backlight and indicator
- Package: 2000 pcs / reel
- Moisture sensitivity level: 3
- Halogen-free
- RoHS compliant

APPLICATIONS

- Backlight
- Status indicator
- Home and smart appliances
- Wearable and portable devices
- Healthcare applications

PACKAGE DIMENSIONS

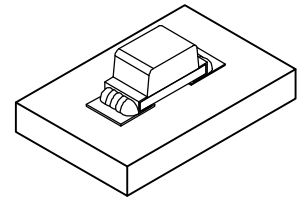
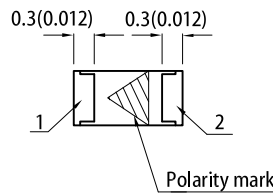
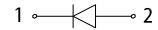
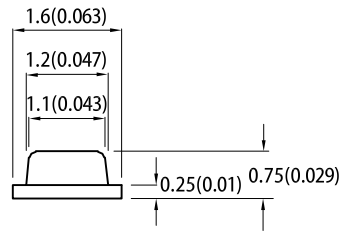
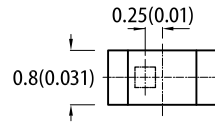

RECOMMENDED SOLDERING PATTERN

(units : mm; tolerance : ± 0.1)



Notes:

- All dimensions are in millimeters (inches).
- Tolerance is ±0.1(0.004") unless otherwise noted.
- The specifications, characteristics and technical data described in the datasheet are subject to change without prior notice.
- The device has a single mounting surface. The device must be mounted according to the specifications.

SELECTION GUIDE

Part Number	Emitting Color (Material)	Lens Type	Iv (mcd) @ 20mA ^[2]		Viewing Angle ^[1]
			Min.	Typ.	2θ1/2
APT1608SGC	■ Super Bright Green (GaP)	Water Clear	5	12	150°

Notes:
 1. θ1/2 is the angle from optical centerline where the luminous intensity is 1/2 of the optical peak value.
 2. Luminous intensity / luminous flux: +/-15%.
 3. Luminous intensity value is traceable to CIE127-2007 standards.

ELECTRICAL / OPTICAL CHARACTERISTICS at $T_A=25^\circ\text{C}$

Parameter	Symbol	Emitting Color	Value		Unit
			Typ.	Max.	
Wavelength at Peak Emission $I_F = 20\text{mA}$	λ_{peak}	Super Bright Green	565	-	nm
Dominant Wavelength $I_F = 20\text{mA}$	$\lambda_{\text{dom}}^{[1]}$	Super Bright Green	568	-	nm
Spectral Bandwidth at 50% Φ REL MAX $I_F = 20\text{mA}$	$\Delta\lambda$	Super Bright Green	30	-	nm
Capacitance	C	Super Bright Green	15	-	pF
Forward Voltage $I_F = 20\text{mA}$	$V_F^{[2]}$	Super Bright Green	2.2	2.5	V
Reverse Current ($V_R = 5\text{V}$)	I_R	Super Bright Green	-	10	μA
Temperature Coefficient of λ_{peak} $I_F = 20\text{mA}$, $-10^\circ\text{C} \leq T \leq 85^\circ\text{C}$	$\text{TC}_{\lambda_{\text{peak}}}$	Super Bright Green	0.12	-	$\text{nm}/^\circ\text{C}$
Temperature Coefficient of λ_{dom} $I_F = 20\text{mA}$, $-10^\circ\text{C} \leq T \leq 85^\circ\text{C}$	$\text{TC}_{\lambda_{\text{dom}}}$	Super Bright Green	0.08	-	$\text{nm}/^\circ\text{C}$
Temperature Coefficient of V_F $I_F = 20\text{mA}$, $-10^\circ\text{C} \leq T \leq 85^\circ\text{C}$	TC_V	Super Bright Green	-2.0	-	$\text{mV}/^\circ\text{C}$

Notes:

1. The dominant wavelength (λ_d) above is the setup value of the sorting machine. (Tolerance $\lambda_d : \pm 1\text{nm}$.)

2. Forward voltage: $\pm 0.1\text{V}$.

3. Wavelength value is traceable to CIE127-2007 standards.

4. Excess driving current and / or operating temperature higher than recommended conditions may result in severe light degradation or premature failure.

ABSOLUTE MAXIMUM RATINGS at $T_A=25^\circ\text{C}$

Parameter	Symbol	Value	Unit
Power Dissipation	P_D	62.5	mW
Reverse Voltage	V_R	5	V
Junction Temperature	T_j	110	$^\circ\text{C}$
Operating Temperature	T_{op}	-40 to +85	$^\circ\text{C}$
Storage Temperature	T_{stg}	-40 to +85	$^\circ\text{C}$
DC Forward Current	I_F	25	mA
Peak Forward Current	$I_{\text{FP}}^{[1]}$	140	mA
Electrostatic Discharge Threshold (HBM)	-	8000	V
Thermal Resistance (Junction / Ambient)	$R_{\text{th JA}}^{[2]}$	510	$^\circ\text{C}/\text{W}$
Thermal Resistance (Junction / Solder point)	$R_{\text{th JS}}^{[2]}$	330	$^\circ\text{C}/\text{W}$

Notes:

1. 1/10 Duty Cycle, 0.1ms Pulse Width.

2. $R_{\text{th JA}}$, $R_{\text{th JS}}$ Results from mounting on PC board FR4 (pad size $\geq 16\text{mm}^2$ per pad).

3. Relative humidity levels maintained between 40% and 60% in production area are recommended to avoid the build-up of static electricity – Ref JEDEC/JESD625-A and JEDEC/J-STD-033.

TECHNICAL DATA

RELATIVE INTENSITY vs. WAVELENGTH

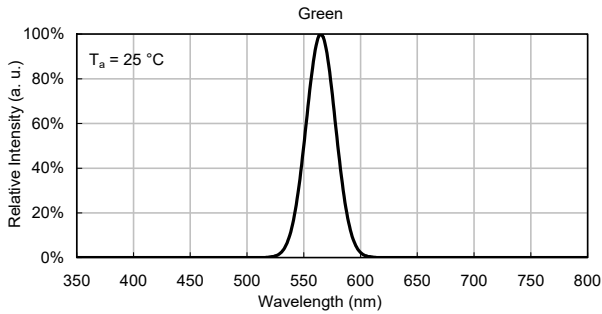

SPATIAL DISTRIBUTION

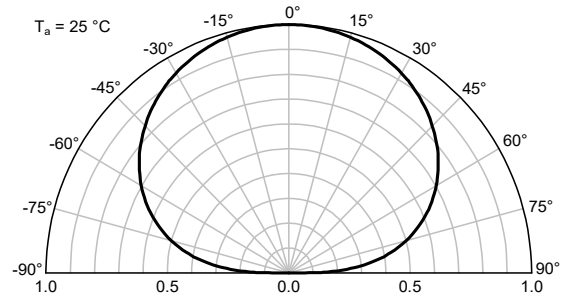

SUPER BRIGHT GREEN

Forward Current vs. Forward Voltage

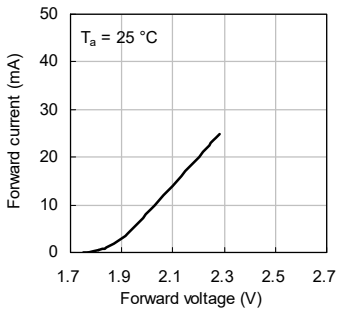

Luminous Intensity vs. Forward Current

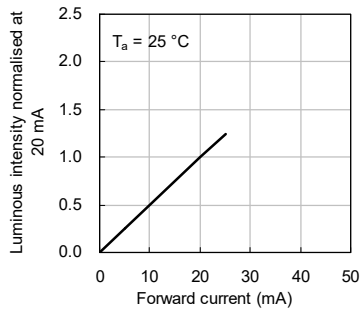

Forward Current Derating Curve

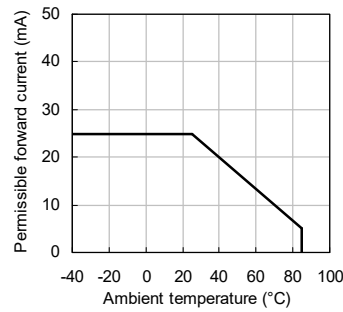

Luminous Intensity vs. Ambient Temperature

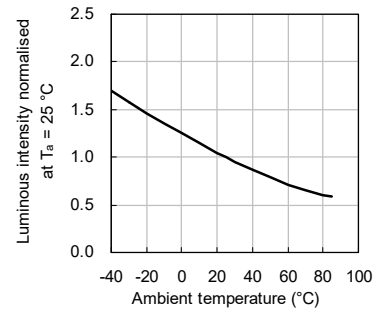

REFLOW SOLDERING PROFILE for LEAD-FREE SMD PROCESS

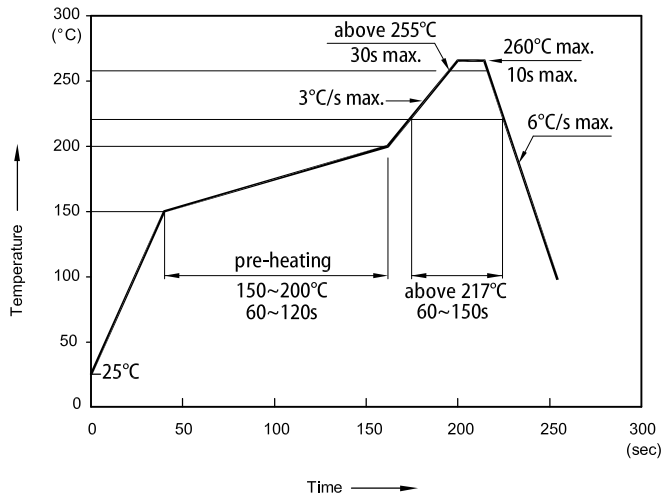

- Notes:
1. Don't cause stress to the LEDs while it is exposed to high temperature.
 2. The maximum number of reflow soldering passes is 2 times.
 3. Reflow soldering is recommended. Other soldering methods are not recommended as they might cause damage to the product.

TAPE SPECIFICATIONS (units : mm)

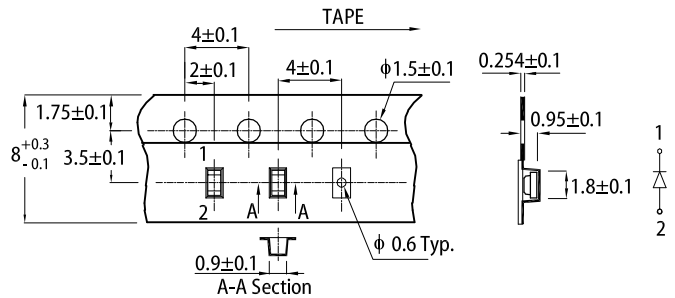

REEL DIMENSION (units : mm)

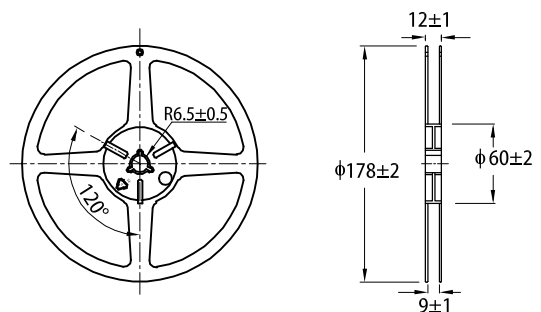

PACKING & LABEL SPECIFICATIONS

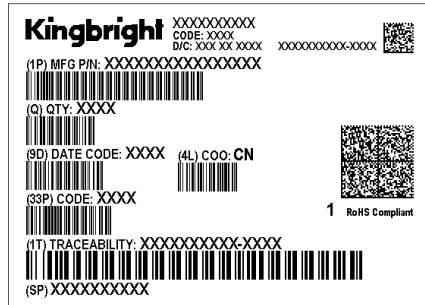
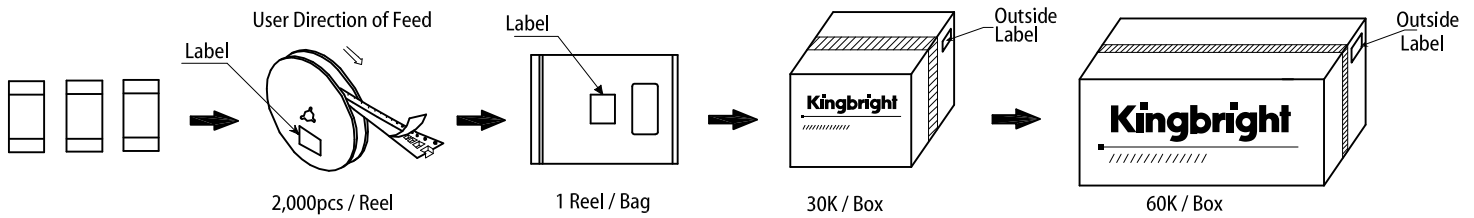

PRECAUTIONARY NOTES

1. The information included in this document reflects representative usage scenarios and is intended for technical reference only.
2. The part number, type, and specifications mentioned in this document are subject to future change and improvement without notice. Before production usage customer should refer to the latest datasheet for the updated specifications.
3. When using the products referenced in this document, please make sure the product is being operated within the environmental and electrical limits specified in the datasheet. If customer usage exceeds the specified limits, Kingbright will not be responsible for any subsequent issues.
4. The information in this document applies to typical usage in consumer electronics applications. If customer's application has special reliability requirements or have life-threatening liabilities, such as automotive or medical usage, please consult with Kingbright representative for further assistance.
5. The contents and information of this document may not be reproduced or re-transmitted without permission by Kingbright.
6. All design applications should refer to Kingbright application notes available at <https://www.KingbrightUSA.com/ApplicationNotes>

Looking for pricing, stock, or lifecycle information?

Click below to explore more details on WIN SOURCE:

 [View APT1608SGC on WIN SOURCE](#)

 [Kingbright Corporation Information](#)

Optimize Your Supply Chain with WIN SOURCE Solutions

-  Global Sourcing Solution
-  Obsolete Management
-  Cost Control Management
-  Shortage Management
-  Alternative Solution
-  Excess Inventory Management