



**THE DATASHEET OF
CDRH104RNP-5R2NC**



SMD Power Inductor CDRH104R



**Halogen
Free**



Dimension - [mm]

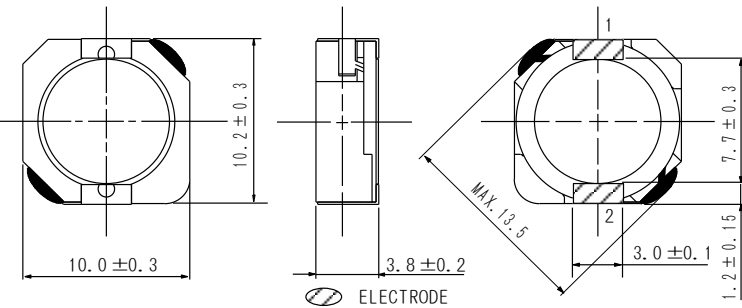

Land pattern and Schematics - [mm]

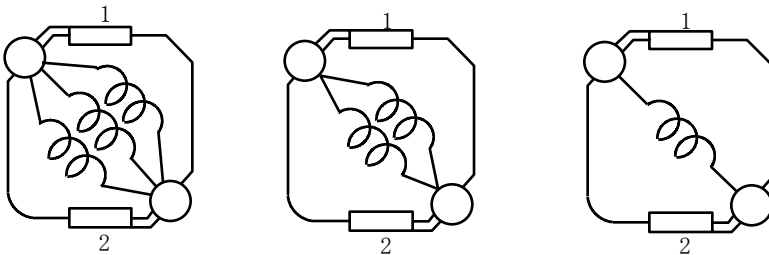
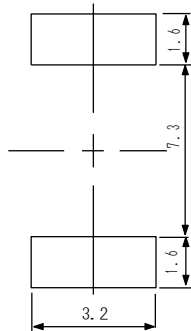

(1.5μH~5.2μH, 10μH) (7.0μH、12μH~33μH) (39μH~330μH)

Description

- Ferrite drum core construction.
- Magnetically shielded.
- L × W × H: 10.5 × 10.3 × 4.0mm Max.
- Product weight: 1.5g(Ref.)
- Moisture Sensitivity Level: 1
- RoHS compliance.
- Halogen Free available.

Environmental Data

- Operating temperature range: -40°C ~ +100°C (including coil's self temperature rise)
- Storage temperature range: -40°C ~ +100°C
- Solder reflow temperature: 260 °C peak.

Packaging

- Carrier tape and reel packaging.
- 13" diameter reel.
- 1000pcs per reel.

Applications

- Ideally used in Notebook PC, LCD TV, DVD, Game machine, STB, Projector etc as DC-DC converter inductors.

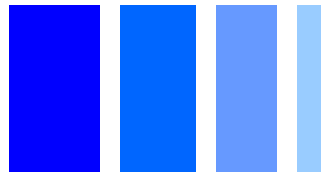

Electrical Characteristics

PART NO.	STAMP	INDUCTANCE [WITHIN] ※1	D. C. R. (mΩ) [MAX.] (TYP.) (at 20°C)	SATURATION CURRENT (A) MAX. (TYP.) ※2	TEMPERATURE RISE CURRENT (A) ※3
CDRH104RNP-1R5NC	1R5	1.5 μH ± 30%	8.1 (6.0)	10.0 (12.5)	8.50
CDRH104RNP-2R5NC	2R5	2.5 μH ± 30%	10.5 (7.8)	7.90 (9.90)	7.70
CDRH104RNP-3R8NC	3R8	3.8 μH ± 30%	13.0 (9.6)	7.00 (8.80)	7.40
CDRH104RNP-5R2NC	5R2	5.2 μH ± 30%	22 (16)	5.60 (7.00)	6.00
CDRH104RNP-7R0NC	7R0	7.0 μH ± 30%	27 (20)	5.25 (6.60)	5.30
CDRH104RNP-100NC	100	10 μH ± 30%	35 (26)	4.48 (5.60)	4.50
CDRH104RNP-120NC	120	12 μH ± 30%	46 (34)	4.00 (5.00)	3.80
CDRH104RNP-150NC	150	15 μH ± 30%	50 (37)	3.50 (4.40)	3.70
CDRH104RNP-180NC	180	18 μH ± 30%	69 (51)	3.25 (4.10)	3.10
CDRH104RNP-220NC	220	22 μH ± 30%	73 (54)	2.85 (3.60)	2.80
CDRH104RNP-270NC	270	27 μH ± 30%	88 (65)	2.60 (3.28)	2.70
CDRH104RNP-330NC	330	33 μH ± 30%	93 (69)	2.30 (2.90)	2.60
CDRH104RNP-390NC	390	39 μH ± 30%	127 (94)	2.10 (2.62)	2.40
CDRH104RNP-470NC	470	47 μH ± 30%	128 (95)	1.95 (2.44)	2.30
CDRH104RNP-560NC	560	56 μH ± 30%	188 (139)	1.74 (2.18)	1.75
CDRH104RNP-680NC	680	68 μH ± 30%	213 (158)	1.66 (2.08)	1.68
CDRH104RNP-820NC	820	82 μH ± 30%	283 (218)	1.50 (1.88)	1.48
CDRH104RNP-101NC	101	100 μH ± 30%	304 (225)	1.33 (1.66)	1.42
CDRH104RNP-121NC	121	120 μH ± 30%	375 (278)	1.25 (1.56)	1.20
CDRH104RNP-151NC	151	150 μH ± 30%	506 (375)	1.12 (1.40)	1.15
CDRH104RNP-181NC	181	180 μH ± 30%	568 (421)	0.99 (1.24)	1.00
CDRH104RNP-221NC	221	220 μH ± 30%	756 (560)	0.95 (1.19)	0.88
CDRH104RNP-271NC	271	270 μH ± 30%	853 (632)	0.85 (1.06)	0.68
CDRH104RNP-331NC	331	330 μH ± 30%	1090 (810)	0.74 (0.92)	0.66

※1 Measuring frequency at 100kHz

※2 Saturation current: this indicates the value of D.C. current when the inductance becomes 35% lower than its initial value. (Ta=20°C)

※3 Temperature rise current: the actual value of D.C. current when the temperature of coil becomes ΔT=40°C (Ta=20°C).

SMD Power Inductor CDRH104R



Saturation Current & Temperature Rise Graph

— L (20°C) — L (105°C) — ΔT

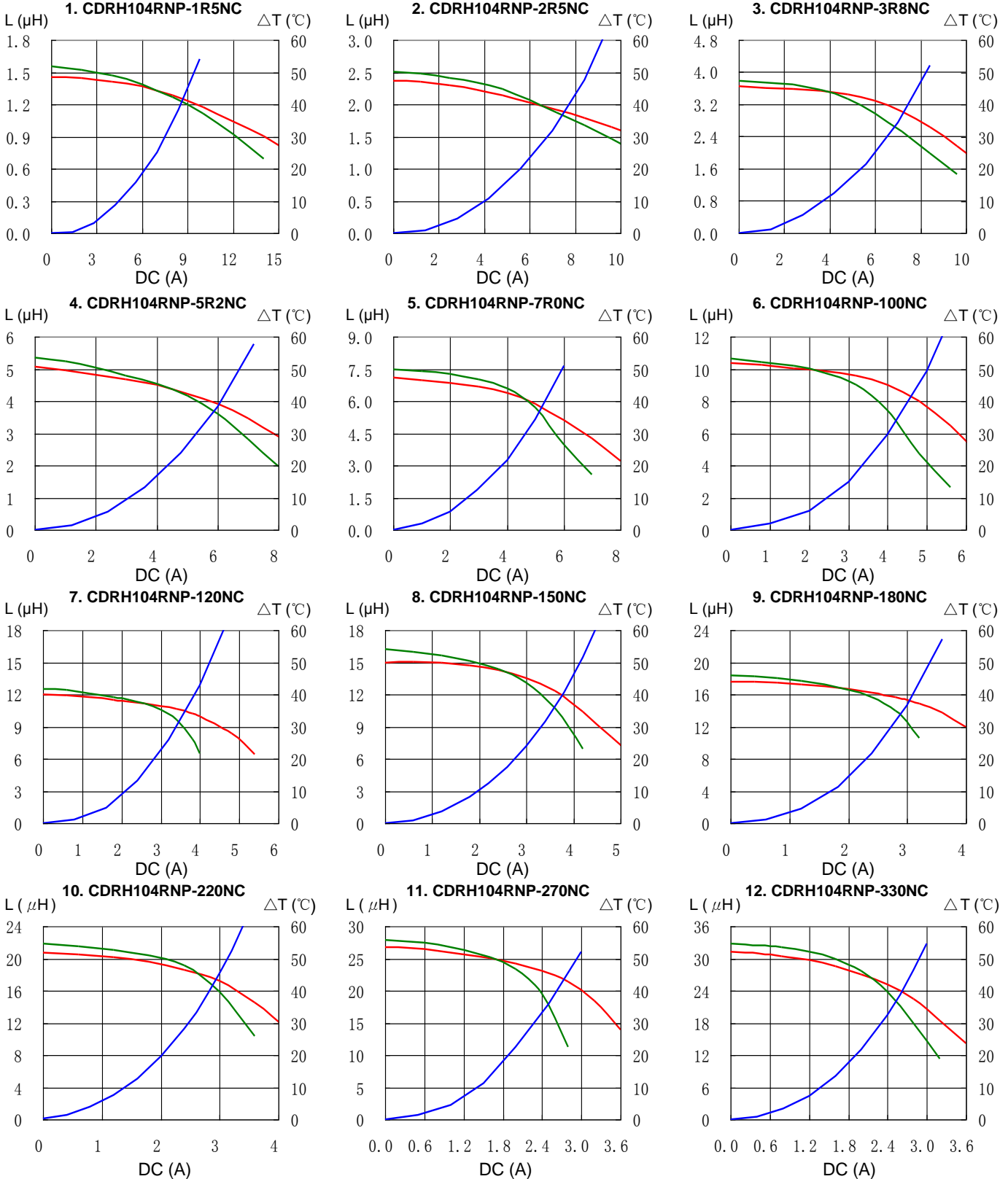

SMD Power Inductor CDRH104R



Saturation Current & Temperature Rise Graph

— L (20°C) — L (105°C) — ΔT

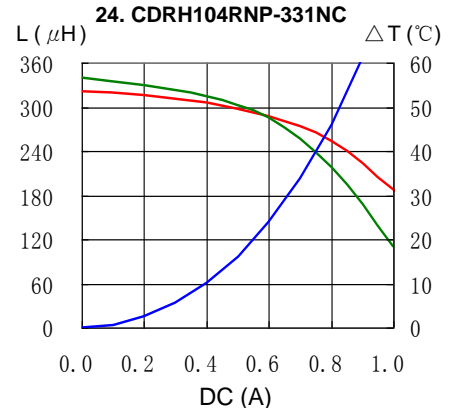
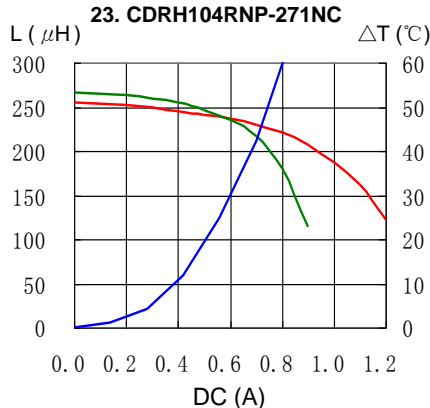
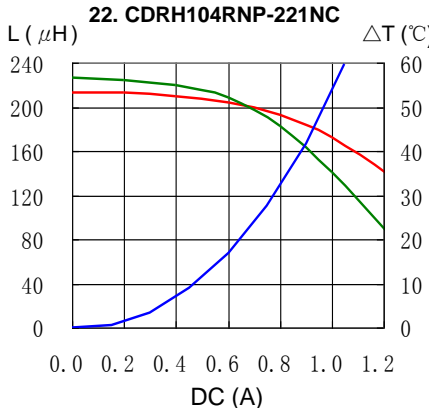
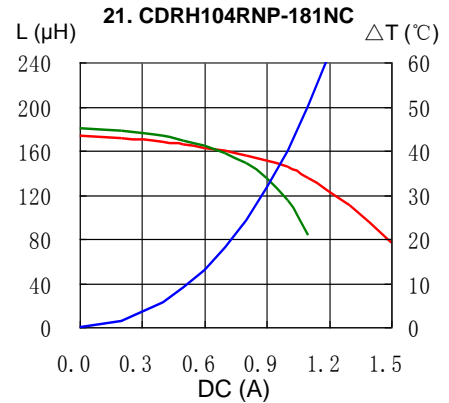
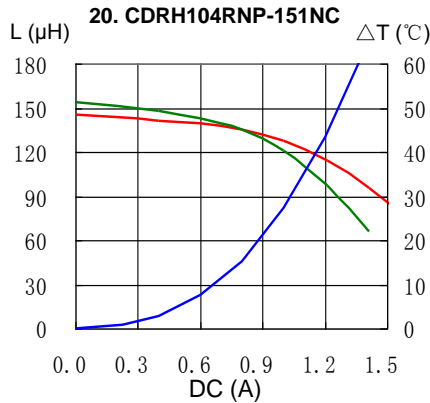
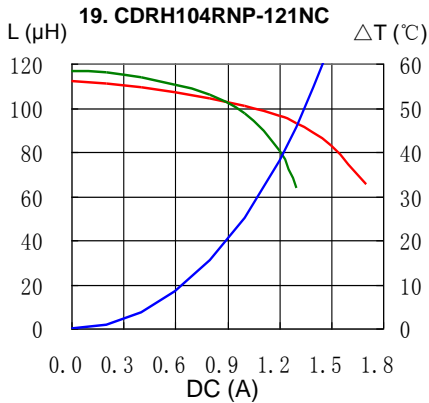
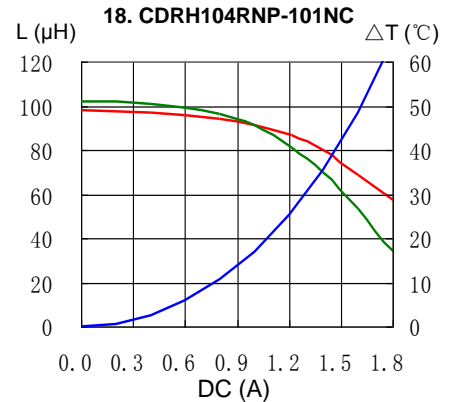
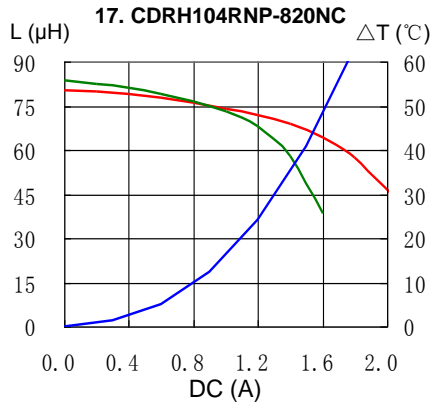
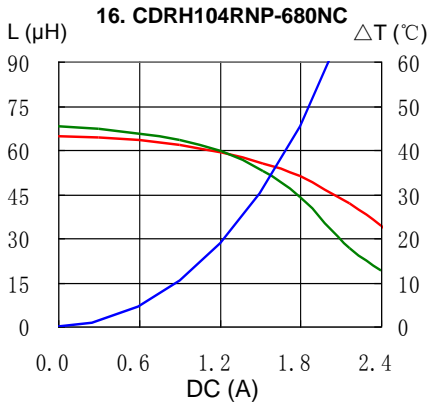
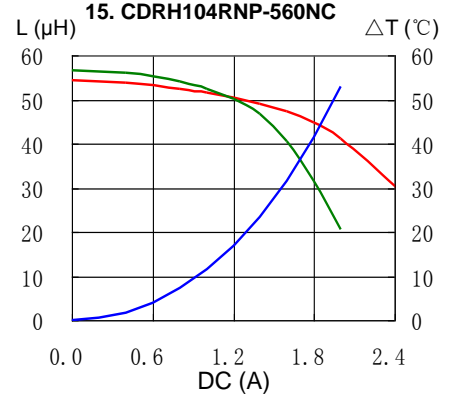
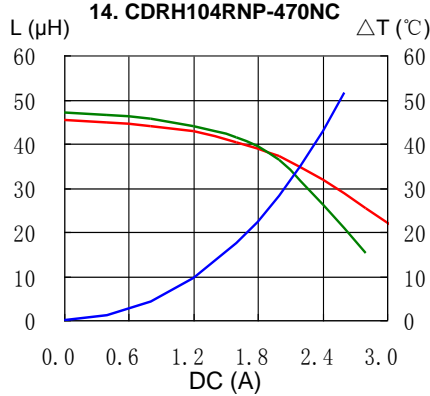
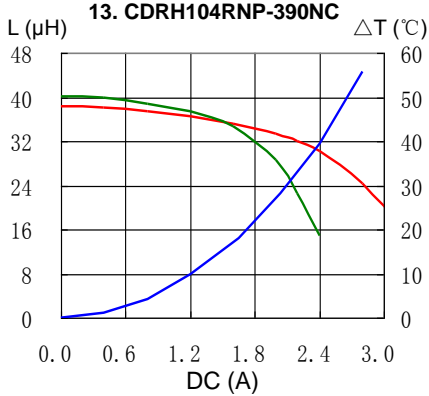

SMD Power Inductor CDRH104R



Solder Reflow Condition

Heat Endurance

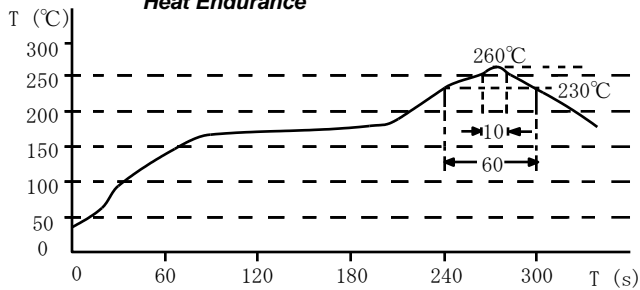

Temperature Chart

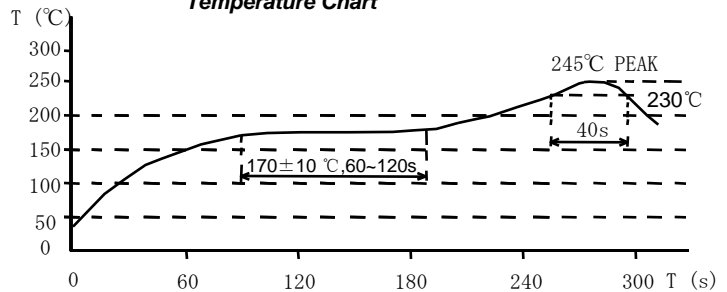

Please refer to the sales offices on our website - <http://www.sumida.com>

Hong Kong

Tel.+852-2880-6781
FAX.+852-2565-9600
sales@hk.sumida.com

Saitama(Japan)

Tel.+81-48-691-7300
FAX.+81-48-691-7340
sales@jp.sumida.com

Chicago

Tel.+1-847-545-6700
FAX. +1-847-545-6720
sales@us.sumida.com

Shanghai

Tel.+86-21-5836-3299
FAX.+86-21-5836-3266
shanghai.sales@cn.sumida.com

Seoul

Tel.+82-2-6237-0777
FAX.+82-2-6237-0778
sales@kr.sumida.com

Obernzell

Tel.+49-8591-937-0
FAX. +49-8591-937-103
contact@eu.sumida.com

Shenzhen

Tel.+86-755-8291-0228
FAX.+86-755-8291-0338
shenzhen.sales@cn.sumida.com

Singapore

Tel.+65-6296-3388
FAX.+65-6841-4426
sales@sg.sumida.com

Neumarkt

Tel.+49-9181-4509-110
FAX. +49-9181-4509-310
infocomp@eu.sumida.com

Taipei

Tel.+886-2-8751-2737
FAX.+886-2-8751-2738
sales@tw.sumida.com

San Jose

Tel.+1-408-321-9660
FAX.+1-408-321-9308
sales@us.sumida.com

Looking for pricing, stock, or lifecycle information?

Click below to explore more details on WIN SOURCE:

- ⊖ [View CDRH104RNP-5R2NC on WIN SOURCE](#)
- ⊖ [Sumida America Components Inc. Information](#)

Optimize Your Supply Chain with WIN SOURCE Solutions

- ✓ Global Sourcing Solution
- ✓ Obsolete Management
- ✓ Cost Control Management
- ✓ Shortage Management
- ✓ Alternative Solution
- ✓ Excess Inventory Management