

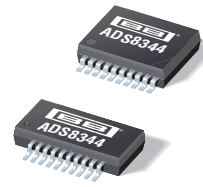

**THE DATASHEET OF  
ADS8344E/2K5G4**





# 16-Bit, 8-Channel Serial Output Sampling ANALOG-TO-DIGITAL CONVERTER

## FEATURES

- PIN FOR PIN WITH ADS7844
- SINGLE SUPPLY: 2.7V to 5V
- 8-CHANNEL SINGLE-ENDED OR 4-CHANNEL DIFFERENTIAL INPUT
- UP TO 100kHz CONVERSION RATE
- 84dB SINAD
- SERIAL INTERFACE
- QSOP-20 AND SSOP-20 PACKAGES

## APPLICATIONS

- DATA ACQUISITION
- TEST AND MEASUREMENT EQUIPMENT
- INDUSTRIAL PROCESS CONTROL
- PERSONAL DIGITAL ASSISTANTS
- BATTERY-POWERED SYSTEMS

## DESCRIPTION

The ADS8344 is an 8-channel, 16-bit, sampling Analog-to-Digital (A/D) converter with a synchronous serial interface. Typical power dissipation is 10mW at a 100kHz throughput rate and a +5V supply. The reference voltage ( $V_{REF}$ ) can be varied between 500mV and  $V_{CC}$ , providing a corresponding input voltage range of 0V to  $V_{REF}$ . The device includes a shutdown mode that reduces power dissipation to under 15 $\mu$ W. The ADS8344 is tested down to 2.7V operation.

Low power, high speed, and an on-board multiplexer make the ADS8344 ideal for battery-operated systems such as personal digital assistants, portable multi-channel data loggers, and measurement equipment. The serial interface also provides low-cost isolation for remote data acquisition. The ADS8344 is available in a QSOP-20 or SSOP-20 package and is ensured over the -40°C to +85°C temperature range.

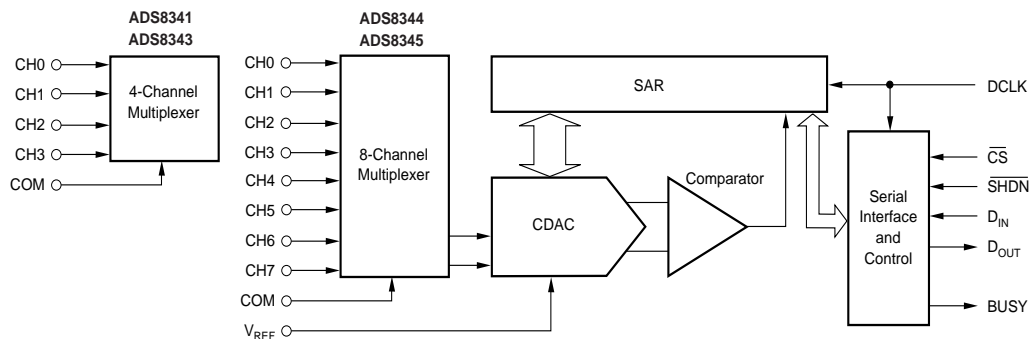

Please be aware that an important notice concerning availability, standard warranty, and use in critical applications of Texas Instruments semiconductor products and disclaimers thereto appears at the end of this data sheet.

All trademarks are the property of their respective owners.

PRODUCTION DATA information is current as of publication date. Products conform to specifications per the terms of Texas Instruments standard warranty. Production processing does not necessarily include testing of all parameters.

## ABSOLUTE MAXIMUM RATINGS<sup>(1)</sup>

+V <sub>CC</sub> to GND .....	-0.3V to +6V
Analog Inputs to GND .....	-0.3V to +V <sub>CC</sub> + 0.3V
Digital Inputs to GND .....	-0.3V to +6V
Power Dissipation .....	250mW
Maximum Junction Temperature .....	+150°C
Operating Temperature Range .....	-40°C to +85°C
Storage Temperature Range .....	-65°C to +150°C
Lead Temperature (soldering, 10s) .....	+300°C

NOTE: (1) Stresses above those listed under Absolute Maximum Ratings may cause permanent damage to the device. Exposure to absolute maximum conditions for extended periods may affect device reliability.



## ELECTROSTATIC DISCHARGE SENSITIVITY

This integrated circuit can be damaged by ESD. Texas Instruments recommends that all integrated circuits be handled with appropriate precautions. Failure to observe proper handling and installation procedures can cause damage.

ESD damage can range from subtle performance degradation to complete device failure. Precision integrated circuits may be more susceptible to damage because very small parametric changes could cause the device not to meet its published specifications.

## PACKAGE/ORDERING INFORMATION<sup>(1)</sup>

PRODUCT	MINIMUM RELATIVE ACCURACY (LSB)	MAXIMUM GAIN ERROR (%)	SPECIFIED TEMPERATURE RANGE	PACKAGE DESIGNATOR	PACKAGE-LEAD	PACKAGE DRAWING NUMBER	ORDERING NUMBER	TRANSPORT MEDIA, QUANTITY
ADS8344E	8	±0.05	-40°C to +85°C	DBQ	QSOP-20	DBQ	ADS8344E	Rails, 56
"	"	"	"	"	"	"	ADS8344E/2K5	Tape and Reel, 2500
ADS8344N	"	"	"	DB	SSOP-20	DB	ADS8344N	Rails, 68
"	"	"	"	"	"	"	ADS8344N/1K	Tape and Reel, 1000
ADS8344EB	6	±0.024	-40°C to +85°C	DBQ	QSOP-20	DBQ	ADS8344EB	Rails, 56
"	"	"	"	"	"	"	ADS8344EB/2K5	Tape and Reel, 2500
ADS8344NB	"	"	"	DB	SSOP-20	DB	ADS8344NB	Rails, 68
"	"	"	"	"	"	"	ADS8344NB/1K	Tape and Reel, 1000

NOTE: (1) For the most current package and ordering information, see the Package Option Addendum at the end of this data sheet, or see the TI web site at [www.ti.com](http://www.ti.com).

## PIN CONFIGURATION

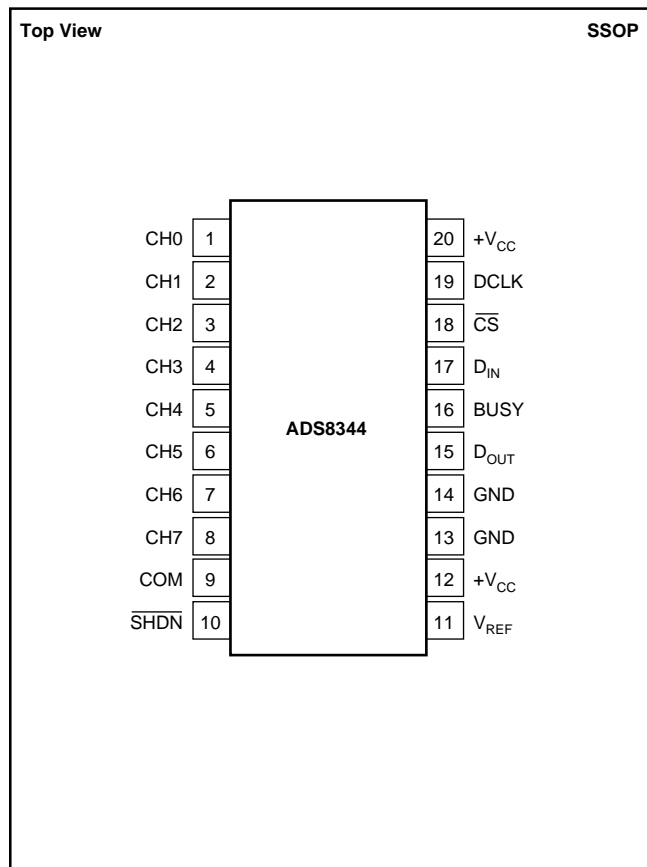

## PIN DESCRIPTIONS

PIN	NAME	DESCRIPTION
1	CH0	Analog Input Channel 0
2	CH1	Analog Input Channel 1
3	CH2	Analog Input Channel 2
4	CH3	Analog Input Channel 3
5	CH4	Analog Input Channel 4
6	CH5	Analog Input Channel 5
7	CH6	Analog Input Channel 6
8	CH7	Analog Input Channel 7
9	COM	Ground reference for analog inputs. Sets zero code voltage in single-ended mode. Connect this pin to ground or ground reference point.
10	$\overline{SHDN}$	Shutdown. When LOW, the device enters a very low-power shutdown mode.
11	V <sub>REF</sub>	Voltage Reference Input. See Electrical Characteristics Table for ranges.
12	+V <sub>CC</sub>	Power Supply, 2.7V to 5V
13	GND	Ground
14	GND	Ground
15	D <sub>OUT</sub>	Serial Data Output. Data is shifted on the falling edge of DCLK. This output is high impedance when $\overline{CS}$ is HIGH.
16	BUSY	Busy Output. Busy goes LOW when the D <sub>IN</sub> control bits are being read and also when the device is converting. The Output is high impedance when $\overline{CS}$ is HIGH.
17	D <sub>IN</sub>	Serial Data Input. If $\overline{CS}$ is LOW, data is latched on rising edge of D <sub>CLK</sub> .
18	$\overline{CS}$	Chip Select Input. Active LOW. Data will not be clocked into D <sub>IN</sub> unless $\overline{CS}$ is LOW. When $\overline{CS}$ is HIGH, D <sub>OUT</sub> is high impedance.
19	DCLK	External Clock Input. The clock speed determines the conversion rate by the equation $f_{DCLK} = 24 \cdot f_{SAMPLE}$ .
20	+V <sub>CC</sub>	Power Supply

# ELECTRICAL CHARACTERISTICS: +5V

At  $T_A = -40^{\circ}\text{C}$  to  $+85^{\circ}\text{C}$ ,  $+V_{CC} = +5\text{V}$ ,  $V_{REF} = +5\text{V}$ ,  $f_{\text{SAMPLE}} = 100\text{kHz}$ , and  $f_{\text{CLK}} = 24 \cdot f_{\text{SAMPLE}} = 2.4\text{MHz}$ , unless otherwise noted.

PARAMETER	CONDITIONS	ADS8344E, N			ADS8344EB, NB			UNITS
		MIN	TYP	MAX	MIN	TYP	MAX	
<b>RESOLUTION</b>			16				*	<b>BITS</b>
<b>ANALOG INPUT</b>								
Full-Scale Input Span	Positive Input - Negative Input	0		$V_{\text{REF}}$	*		*	V
Absolute Input Range	Positive Input	-0.2		$+V_{\text{CC}} + 0.2$	*		*	V
	Negative Input	-0.2		+1.25	*		*	V
Capacitance			25			*		pF
Leakage Current			$\pm 1$			*		$\mu\text{A}$
<b>SYSTEM PERFORMANCE</b>								
No Missing Codes		14			15			Bits
Integral Linearity Error				8		6		LSB
Offset Error				$\pm 2$		$\pm 1$		mV
Offset Error Match			1.2	4	*	*		LSB <sup>(1)</sup>
Gain Error				$\pm 0.05$		$\pm 0.024$		%
Gain Error Match			1.0	4	*	*		LSB
Noise			20		*	*		$\mu\text{V}_{\text{rms}}$
Power-Supply Rejection	$+4.75\text{V} < V_{\text{CC}} < 5.25\text{V}$		3		*	*		LSB <sup>(1)</sup>
<b>SAMPLING DYNAMICS</b>								
Conversion Time				16		*		CLK Cycles
Acquisition Time		4.5			*			CLK Cycles
Throughput Rate				100		*		kHz
Multiplexer Settling Time			500			*		ns
Aperture Delay			30			*		ns
Aperture Jitter			100			*		ps
Internal Clock Frequency	$\overline{\text{SHDN}} = V_{\text{DD}}$		2.4			*		MHz
External Clock Frequency	Data Transfer Only	0.024		2.4	*	*		MHz
		0		2.4	*	*		MHz
<b>DYNAMIC CHARACTERISTICS</b>								
Total Harmonic Distortion <sup>(2)</sup>	$V_{\text{IN}} = 5\text{Vp-p}$ at 10kHz		-90			*		dB
Signal-to-(Noise + Distortion)	$V_{\text{IN}} = 5\text{Vp-p}$ at 10kHz		86			*		dB
Spurious-Free Dynamic Range	$V_{\text{IN}} = 5\text{Vp-p}$ at 10kHz		92			*		dB
Channel-to-Channel Isolation	$V_{\text{IN}} = 5\text{Vp-p}$ at 10kHz		100			*		dB
<b>REFERENCE INPUT</b>								
Range		0.5		$+V_{\text{CC}}$	*		*	V
Resistance	DCLK Static		5			*		$\text{G}\Omega$
Input Current			40	100		*	*	$\mu\text{A}$
	$f_{\text{SAMPLE}} = 12.5\text{kHz}$		2.5			*	*	$\mu\text{A}$
	DCLK Static		0.001	3		*	*	$\mu\text{A}$
<b>DIGITAL INPUT/OUTPUT</b>								
Logic Family			CMOS			*		
Logic Levels								
$V_{\text{IH}}$	$ I_{\text{IH}}  \leq +5\mu\text{A}$	3.0		5.5	*		*	V
$V_{\text{IL}}$	$ I_{\text{IL}}  \leq +5\mu\text{A}$	-0.3		+0.8	*		*	V
$V_{\text{OH}}$	$I_{\text{OH}} = -250\mu\text{A}$	3.5			*		*	V
$V_{\text{OL}}$	$I_{\text{OL}} = 250\mu\text{A}$			0.4			*	V
Data Format				Straight Binary		*		
<b>POWER-SUPPLY REQUIREMENTS</b>								
$+V_{\text{CC}}$	Specified Performance	4.75		5.25	*		*	V
Quiescent Current			1.5	2.0			*	mA
	$f_{\text{SAMPLE}} = 100\text{kHz}$		300			*		$\mu\text{A}$
	Power-Down Mode <sup>(3)</sup> , $\overline{\text{CS}} = +V_{\text{CC}}$			3			*	$\mu\text{A}$
Power Dissipation			7.5	10			*	mW
<b>TEMPERATURE RANGE</b>								
Specified Performance		-40		+85	*		*	$^{\circ}\text{C}$

\* Same specifications as ADS8344E, N.

NOTES: (1) LSB means Least Significant Bit. With  $V_{\text{REF}}$  equal to +5.0V, one LSB is 76 $\mu\text{V}$ . (2) First nine harmonics of the test frequency. (3) Auto power-down mode (PD1 = PD0 = 0) active or  $\overline{\text{SHDN}} = \text{GND}$ .

# ELECTRICAL CHARACTERISTICS: +2.7V

At  $T_A = -40^{\circ}\text{C}$  to  $+85^{\circ}\text{C}$ ,  $+V_{CC} = +2.7\text{V}$ ,  $V_{REF} = +2.7\text{V}$ ,  $f_{SAMPLE} = 100\text{kHz}$ , and  $f_{CLK} = 24 \cdot f_{SAMPLE} = 2.4\text{MHz}$ , unless otherwise noted.

PARAMETER	CONDITIONS	ADS8344E, N			ADS8344EB, NB			UNITS
		MIN	TYP	MAX	MIN	TYP	MAX	
<b>RESOLUTION</b>			16				*	<b>BITS</b>
<b>ANALOG INPUT</b>								
Full-Scale Input Span	Positive Input - Negative Input	0		$V_{REF}$	*		*	V
Absolute Input Range	Positive Input	-0.2		$+V_{CC} + 0.2$	*		*	V
	Negative Input	-0.2			*		*	V
Capacitance			25			*		pF
Leakage Current			$\pm 1$			*		$\mu\text{A}$
<b>SYSTEM PERFORMANCE</b>								
No Missing Codes		14			15			Bits
Integral Linearity Error				12		8		LSB
Offset Error				$\pm 1$		0.5		mV
Offset Error Match			1.2	4	*	*		LSB
Gain Error				$\pm 0.05$		$\pm 0.024$		% of FSR
Gain Error Match			1	4	*	*		LSB
Noise			20		*	*		$\mu\text{Vrms}$
Power-Supply Rejection	$+2.7 < V_{CC} < +3.3\text{V}$		3		*	*		LSB <sup>(1)</sup>
<b>SAMPLING DYNAMICS</b>								
Conversion Time				16		*		CLK Cycles
Acquisition Time		4.5			*			CLK Cycles
Throughput Rate				100		*		kHz
Multiplexer Settling Time			500			*		ns
Aperture Delay			30			*		ns
Aperture Jitter			100			*		ps
Internal Clock Frequency	$\overline{\text{SHDN}} = V_{DD}$		2.4			*		MHz
External Clock Frequency		0.024		2.4				MHz
	When used with Internal Clock Data Transfer Only	0.024		2.0	*		*	MHz
		0		2.4	*		*	MHz
<b>DYNAMIC CHARACTERISTICS</b>								
Total Harmonic Distortion <sup>(2)</sup>	$V_{IN} = 2.5\text{Vp-p}$ at 1kHz		-90			*		dB
Signal-to-(Noise + Distortion)	$V_{IN} = 2.5\text{Vp-p}$ at 1kHz		86			*		dB
Spurious-Free Dynamic Range	$V_{IN} = 2.5\text{Vp-p}$ at 1kHz		92			*		dB
Channel-to-Channel Isolation	$V_{IN} = 2.5\text{Vp-p}$ at 10kHz		100			*		dB
<b>REFERENCE INPUT</b>								
Range		0.5		$+V_{CC}$	*		*	V
Resistance	DCLK Static		5			*		$\text{G}\Omega$
Input Current			13	40		*	*	$\mu\text{A}$
	$f_{SAMPLE} = 12.5\text{kHz}$		2.5			*		$\mu\text{A}$
	DCLK Static		0.001	3		*	*	$\mu\text{A}$
<b>DIGITAL INPUT/OUTPUT</b>								
Logic Family			CMOS			*		
Logic Levels								
$V_{IH}$	$ I_{IH}  \leq +5\mu\text{A}$	$+V_{CC} \cdot 0.7$		5.5	*		*	V
$V_{IL}$	$ I_{IL}  \leq +5\mu\text{A}$	-0.3		+0.8	*		*	V
$V_{OH}$	$I_{OH} = -250\mu\text{A}$	$+V_{CC} \cdot 0.8$			*		*	V
$V_{OL}$	$I_{OL} = 250\mu\text{A}$			0.4			*	V
Data Format				Straight Binary		*		
<b>POWER-SUPPLY REQUIREMENTS</b>								
$+V_{CC}$	Specified Performance	2.7		3.6	*		*	V
Quiescent Current			1.2	1.85		*	*	mA
	$f_{SAMPLE} = 100\text{kHz}$		220			*	*	$\mu\text{A}$
	Power-Down Mode <sup>(3)</sup> , $\overline{\text{CS}} = +V_{CC}$			3			*	$\mu\text{A}$
Power Dissipation			3.2	5			*	mW
<b>TEMPERATURE RANGE</b>								
Specified Performance		-40		+85	*		*	$^{\circ}\text{C}$

\* Same specifications as ADS8344E, N.

NOTES: (1) LSB means Least Significant Bit. With  $V_{REF}$  equal to +2.5V, one LSB is 38 $\mu\text{V}$ . (2) First nine harmonics of the test frequency. (3) Auto power-down mode (PD1 = PD0 = 0) active or  $\overline{\text{SHDN}} = \text{GND}$ .

# TYPICAL CHARACTERISTICS: +5V

At  $T_A = +25^\circ\text{C}$ ,  $V_{CC} = +5\text{V}$ ,  $V_{REF} = +5\text{V}$ ,  $f_{\text{SAMPLE}} = 100\text{kHz}$ , and  $f_{\text{DCLK}} = 24 \cdot f_{\text{SAMPLE}} = 2.4\text{MHz}$ , unless otherwise noted.

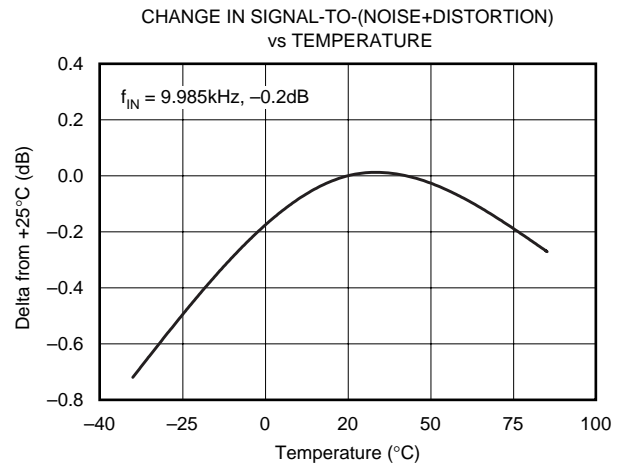
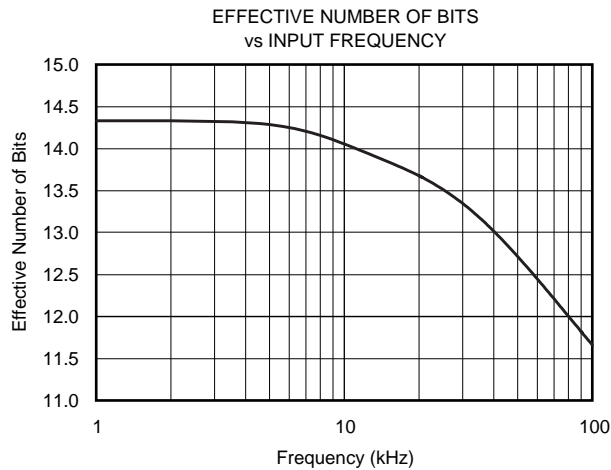
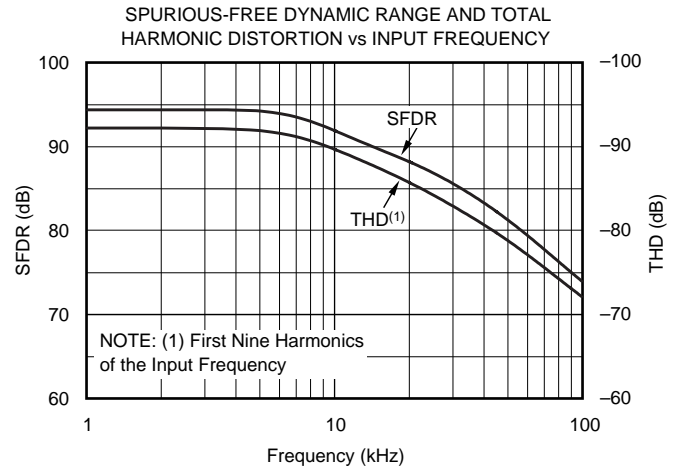
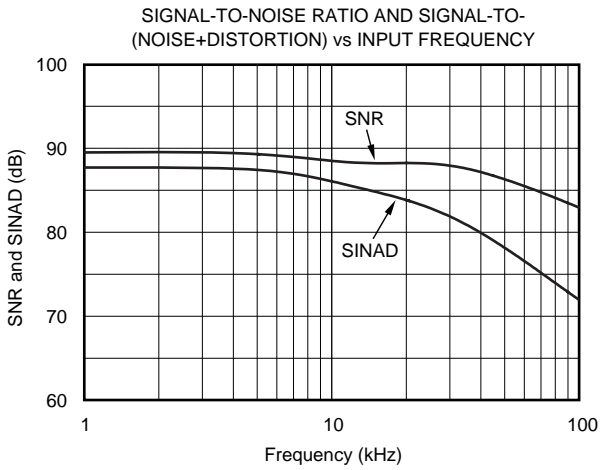
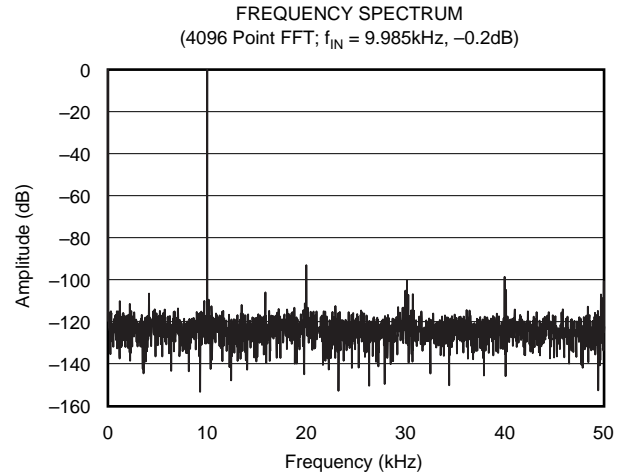
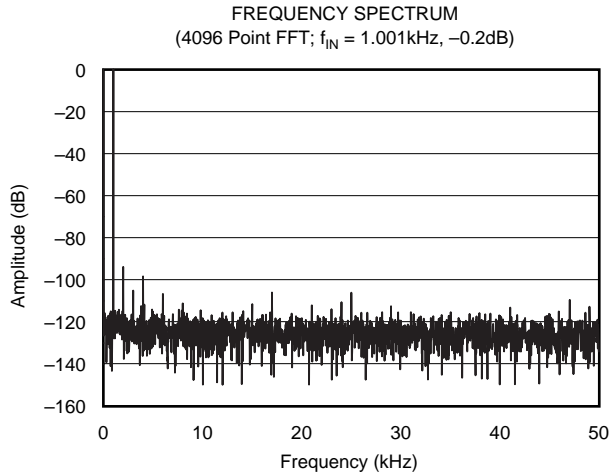

# TYPICAL CHARACTERISTICS: +5V (Cont.)

At  $T_A = +25^\circ\text{C}$ ,  $+V_{CC} = +5\text{V}$ ,  $V_{REF} = +5\text{V}$ ,  $f_{\text{SAMPLE}} = 100\text{kHz}$ , and  $f_{\text{DCLK}} = 24 \cdot f_{\text{SAMPLE}} = 2.4\text{MHz}$ , unless otherwise noted.

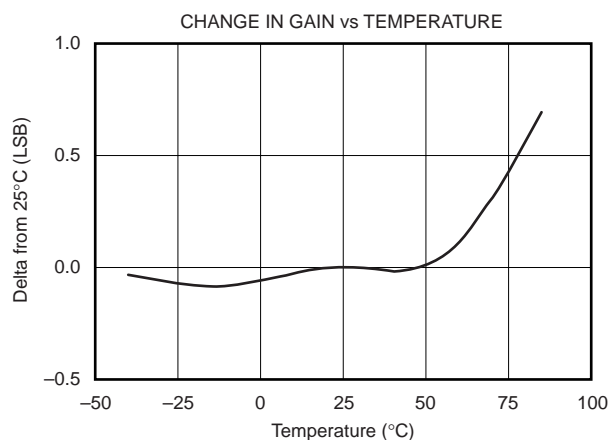
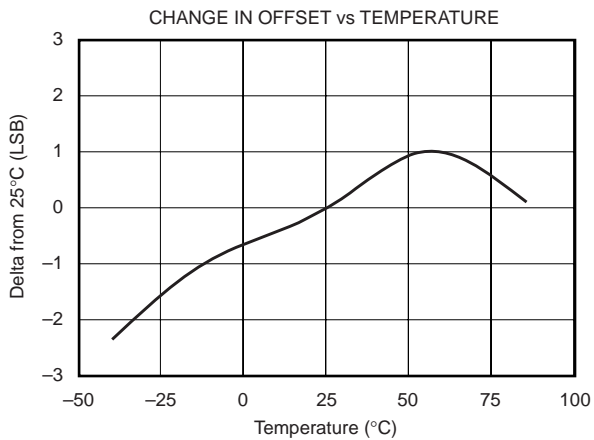
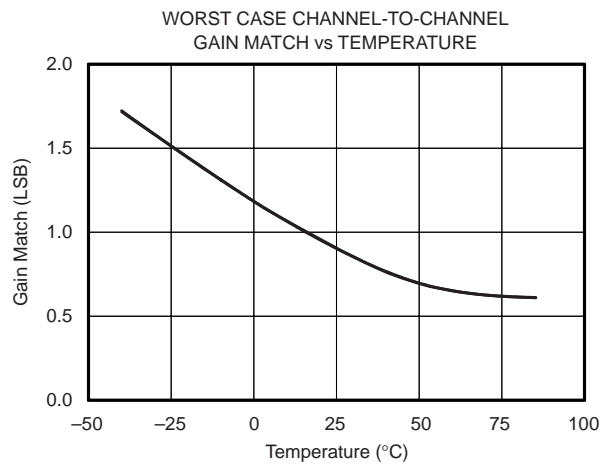
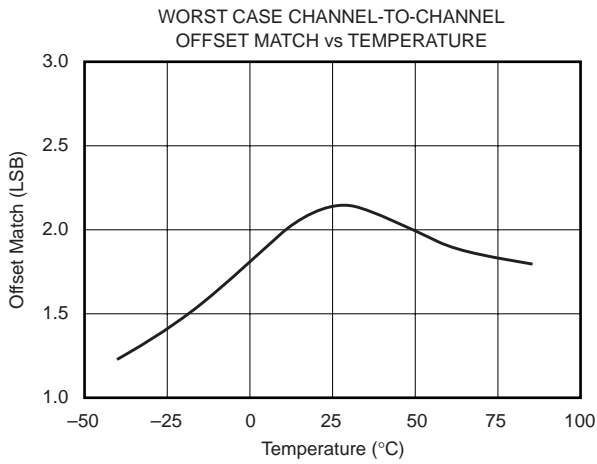
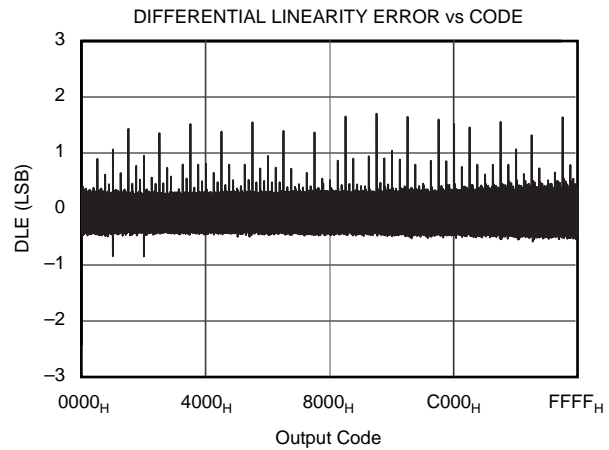
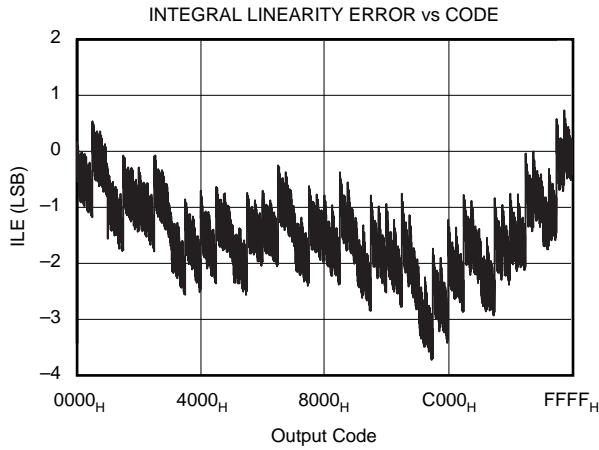

# TYPICAL CHARACTERISTICS: +5V (Cont.)

At  $T_A = +25^\circ\text{C}$ ,  $+V_{CC} = +5\text{V}$ ,  $V_{REF} = +5\text{V}$ ,  $f_{\text{SAMPLE}} = 100\text{kHz}$ , and  $f_{\text{DCLK}} = 24 \cdot f_{\text{SAMPLE}} = 2.4\text{MHz}$ , unless otherwise noted.

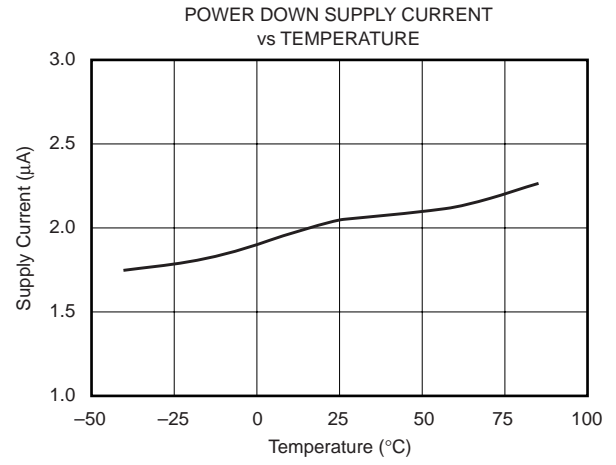
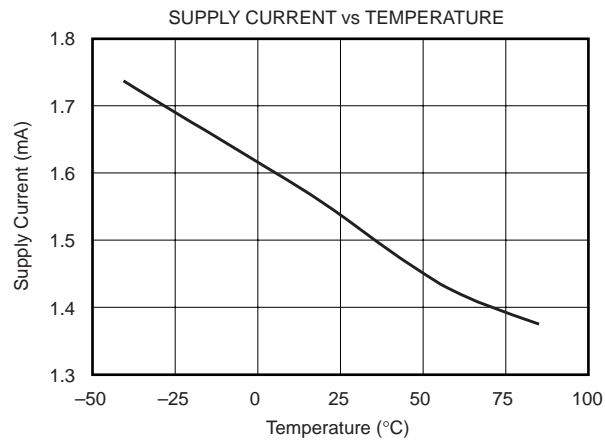

# TYPICAL CHARACTERISTICS: +2.7V

At  $T_A = +25^\circ\text{C}$ ,  $+V_{CC} = +2.7\text{V}$ ,  $V_{REF} = +2.7\text{V}$ ,  $f_{\text{SAMPLE}} = 100\text{kHz}$ , and  $f_{\text{DCLK}} = 24 \cdot f_{\text{SAMPLE}} = 2.4\text{MHz}$ , unless otherwise noted.

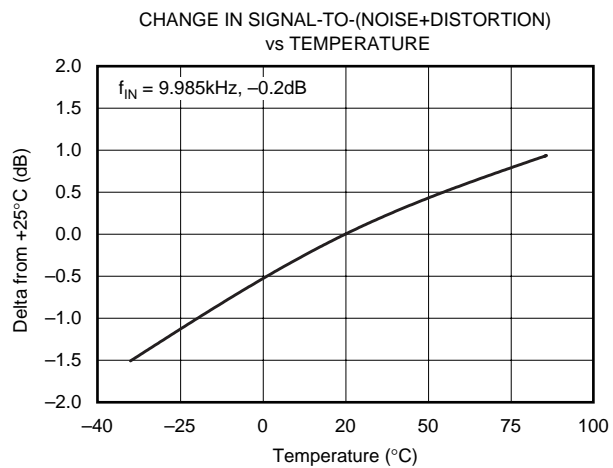
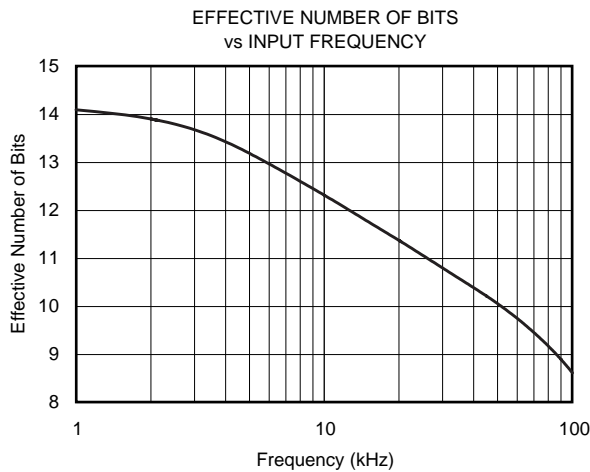
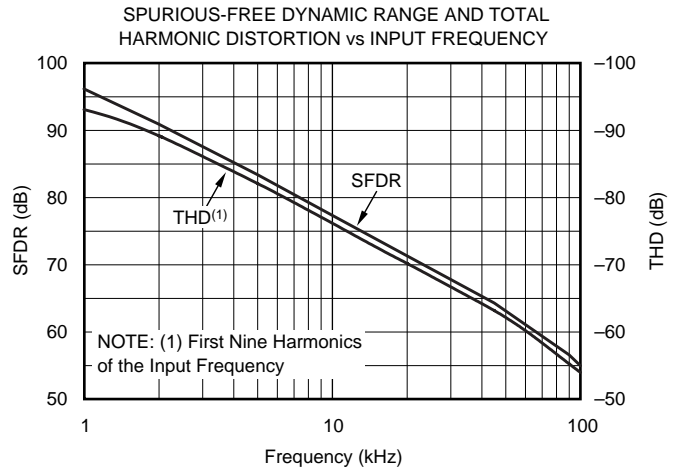
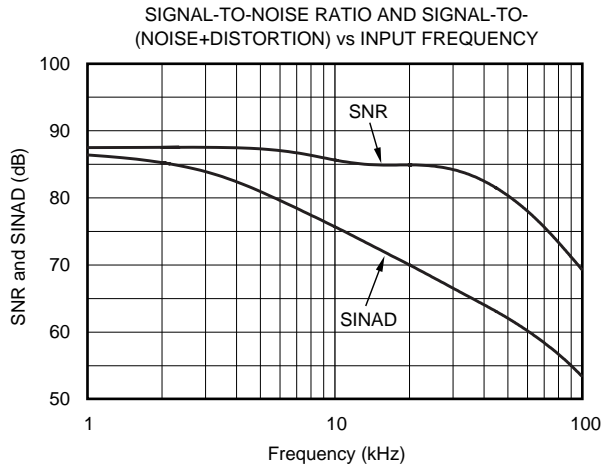
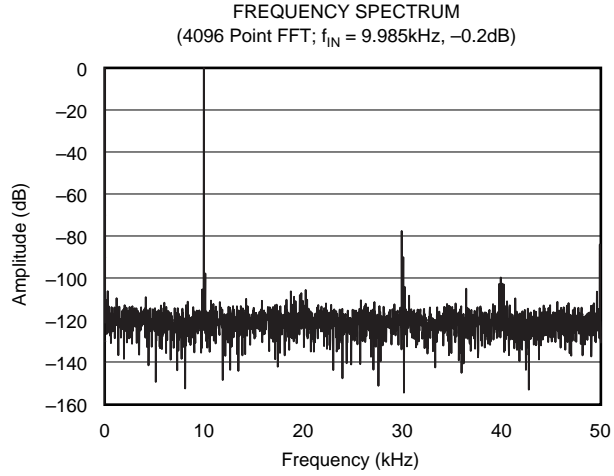
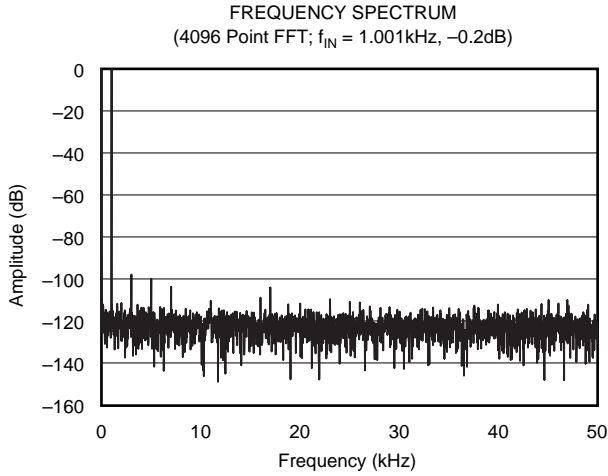

# TYPICAL CHARACTERISTICS: +2.7V (Cont.)

At  $T_A = +25^\circ\text{C}$ ,  $+V_{CC} = +2.7\text{V}$ ,  $V_{REF} = +2.7\text{V}$ ,  $f_{\text{SAMPLE}} = 100\text{kHz}$ , and  $f_{\text{DCLK}} = 24 \cdot f_{\text{SAMPLE}} = 2.4\text{MHz}$ , unless otherwise noted.

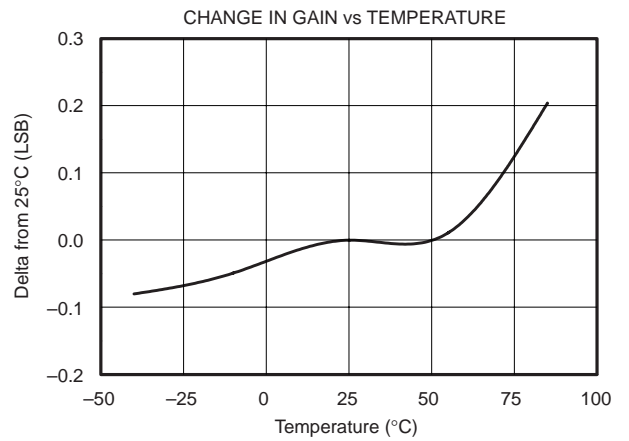
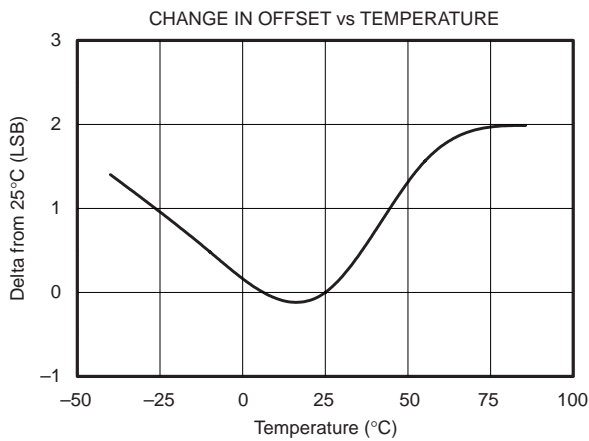
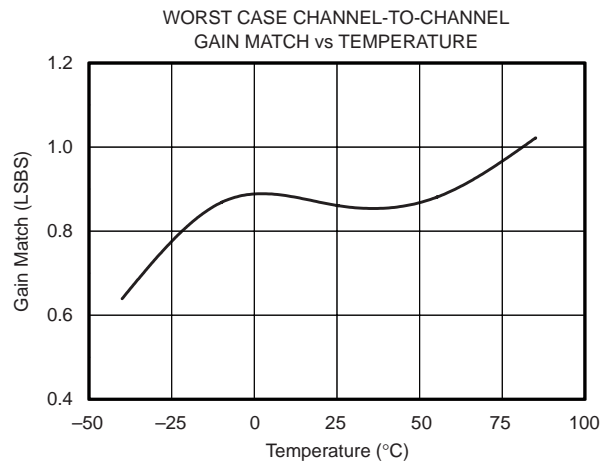
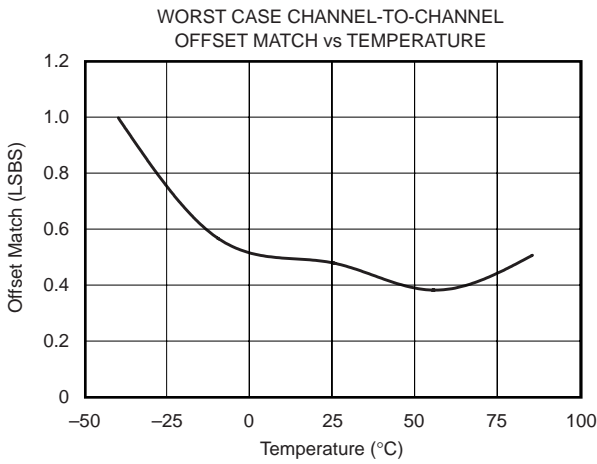
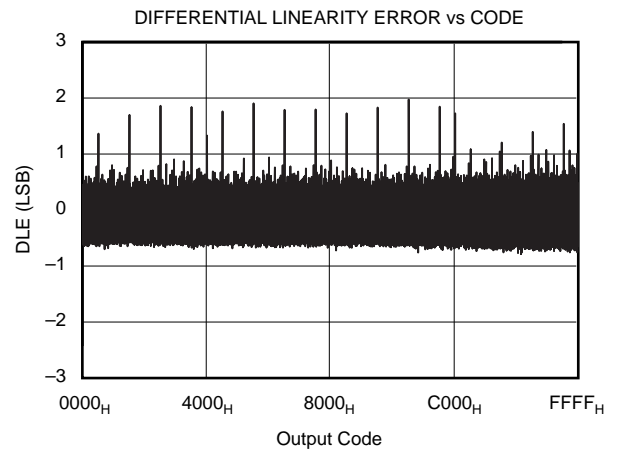
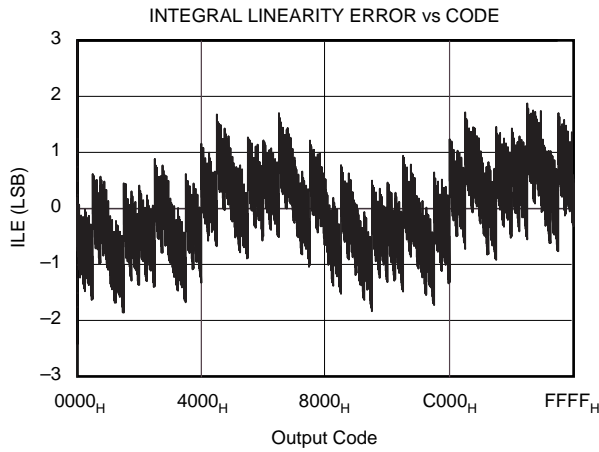

# TYPICAL CHARACTERISTICS: +2.7V (Cont.)

At  $T_A = +25^\circ\text{C}$ ,  $+V_{CC} = +2.7\text{V}$ ,  $V_{REF} = +2.7\text{V}$ ,  $f_{SAMPLE} = 100\text{kHz}$ , and  $f_{DCLK} = 24 \cdot f_{SAMPLE} = 2.4\text{MHz}$ , unless otherwise noted.

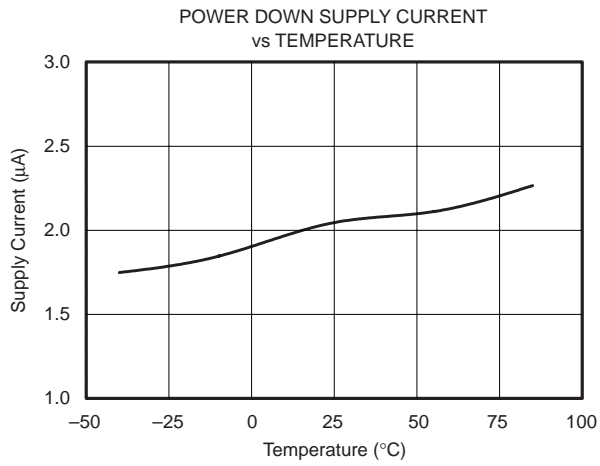
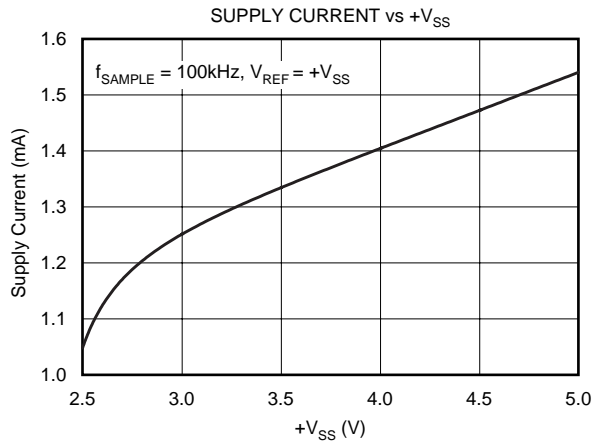
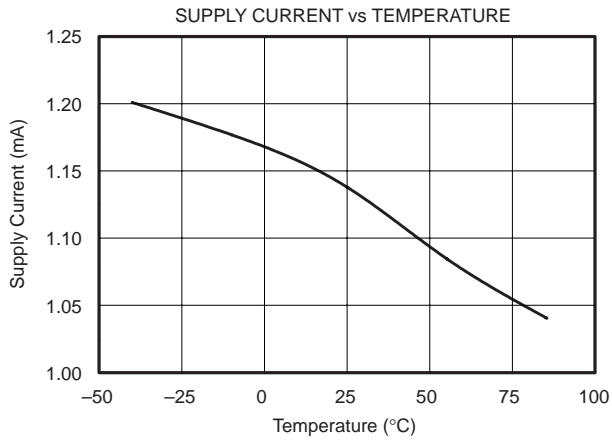

# THEORY OF OPERATION

The ADS8344 is a classic Successive Approximation Register (SAR) A/D converter. The architecture is based on capacitive redistribution that inherently includes a sample-and-hold function. The converter is fabricated on a 0.6 $\mu$ m CMOS process.

The basic operation of the ADS8344 is shown in Figure 1. The device requires an external reference and an external clock. It operates from a single supply of 2.7V to 5.25V. The external reference can be any voltage between 500mV and +V<sub>CC</sub>. The value of the reference voltage directly sets the input range of the converter. The average reference input current depends on the conversion rate of the ADS8344.

The analog input to the converter is differential and is provided via an 8-channel multiplexer. The input can be provided in reference to a voltage on the COM pin (which is generally ground) or differentially by using four of the eight input channels (CH0 - CH7). The particular configuration is selectable via the digital interface.

A2	A1	A0	CH0	CH1	CH2	CH3	CH4	CH5	CH6	CH7	COM
0	0	0	+IN								-IN
1	0	0		+IN							-IN
0	0	1			+IN						-IN
1	0	1				+IN					-IN
0	1	0					+IN				-IN
1	1	0						+IN			-IN
0	1	1							+IN		-IN
1	1	1								+IN	-IN

TABLE I. Single-Ended Channel Selection (SGL/DIF HIGH).

# ANALOG INPUT

See Figure 2 for a block diagram of the input multiplexer on the ADS8344. The differential input of the converter is derived from one of the eight inputs in reference to the COM pin, or four of the eight inputs. Table I and Table II show the relationship between the A2, A1, A0, and SGL/DIF control bits and the configuration of the analog multiplexer. The control bits are provided serially via the D<sub>IN</sub> pin (see the Digital Interface section of this data sheet for more details).

When the converter enters the hold mode, the voltage difference between the +IN and -IN inputs is captured on the internal capacitor array (see Figure 2). The voltage on the -IN input is limited between -0.2V and 1.25V, allowing the input to reject small signals that are common to both the +IN and -IN input. The +IN input has a range of -0.2V to +V<sub>CC</sub> + 0.2V.

The input current on the analog inputs depends on the conversion rate of the device. During the sample period, the source must charge the internal sampling capacitor (typically 25pF). After the capacitor has been fully charged, there is no further input current. The rate of charge transfer from the analog source to the converter is a function of conversion rate.

A2	A1	A0	CH0	CH1	CH2	CH3	CH4	CH5	CH6	CH7
0	0	0	+IN	-IN						
0	0	1			+IN	-IN				
0	1	0					+IN	-IN		
0	1	1							+IN	-IN
1	0	0	-IN	+IN						
1	0	1			-IN	+IN				
1	1	0					-IN	+IN		
1	1	1							-IN	+IN

TABLE II. Differential Channel Control (SGL/DIF LOW).

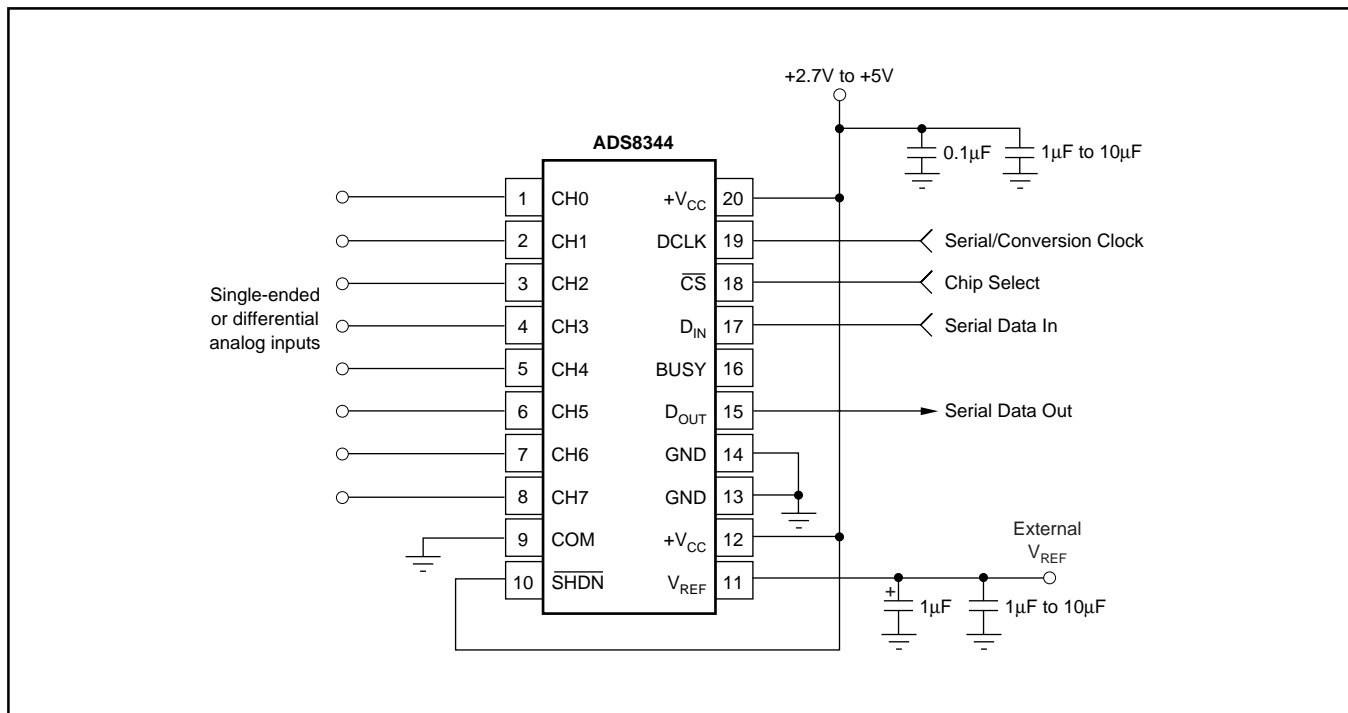

FIGURE 1. Basic Operation of the ADS8344.

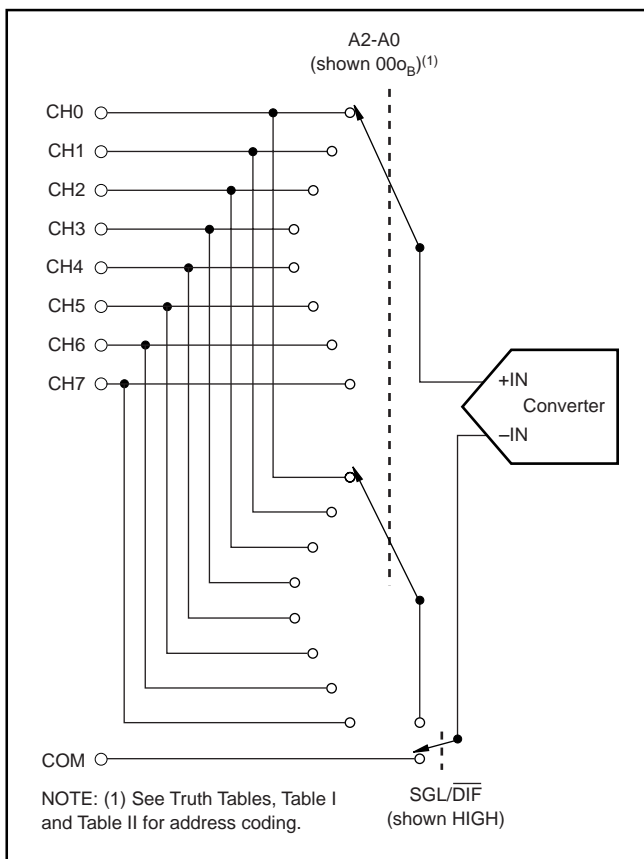

FIGURE 2. Simplified Diagram of the Analog Input.

## REFERENCE INPUT

The external reference sets the analog input range. The ADS8344 will operate with a reference in the range of 100mV to +V<sub>CC</sub>. Keep in mind that the analog input is the difference between the +IN input and the -IN input, as shown in Figure 2. For example, in the single-ended mode, a 1.25V reference with the COM pin grounded, the selected input channel (CH0 - CH7) will properly digitize a signal in the range of 0V to 1.25V. If the COM pin is connected to 0.5V, the input range on the selected channel is 0.5V to 1.75V.

There are several critical items concerning the reference input and its wide-voltage range. As the reference voltage is reduced, the analog voltage weight of each digital output code is also reduced. This is often referred to as the LSB

(Least Significant Bit) size and is equal to the reference voltage divided by 65536. Any offset or gain error inherent in the A/D converter will appear to increase, in terms of LSB size, as the reference voltage is reduced. For example, if the offset of a given converter is 2LSBs with a 2.5V reference, then it will typically be 10LSBs with a 0.5V reference. In each case, the actual offset of the device is the same, 76.3μV.

Likewise, the noise or uncertainty of the digitized output will increase with lower LSB size. With a reference voltage of 500mV, the LSB size is 7.6μV. This level is below the internal noise of the device. As a result, the digital output code will not be stable and will vary around a mean value by a number of LSBs. The distribution of output codes will be gaussian and the noise can be reduced by simply averaging consecutive conversion results or applying a digital filter.

With a lower reference voltage, care should be taken to provide a clean layout including adequate bypassing, a clean (low-noise, low-ripple) power supply, a low-noise reference, and a low-noise input signal. Because the LSB size is lower, the converter will also be more sensitive to nearby digital signals and electromagnetic interference.

The voltage into the V<sub>REF</sub> input is not buffered and directly drives the Capacitor Digital-to-Analog Converter (CDAC) portion of the ADS8344. Typically, the input current is 13μA with a 2.5V reference. This value will vary by microamps depending on the result of the conversion. The reference current diminishes directly with both conversion rate and reference voltage. As the current from the reference is drawn on each bit decision, clocking the converter more quickly during a given conversion period will not reduce overall current drain from the reference.

## DIGITAL INTERFACE

The ADS8344 has a four-wire serial interface compatible with several microprocessor families (note that the digital inputs are over-voltage tolerant up to +5.5V, regardless of +V<sub>CC</sub>). Figure 3 shows the typical operation of the ADS8344 digital interface.

Most microprocessors communicate using 8-bit transfers; the ADS8344 can complete a conversion with three such transfers, for a total of 24 clock cycles on the DCLK input, provided the timing is as shown in Figure 3.

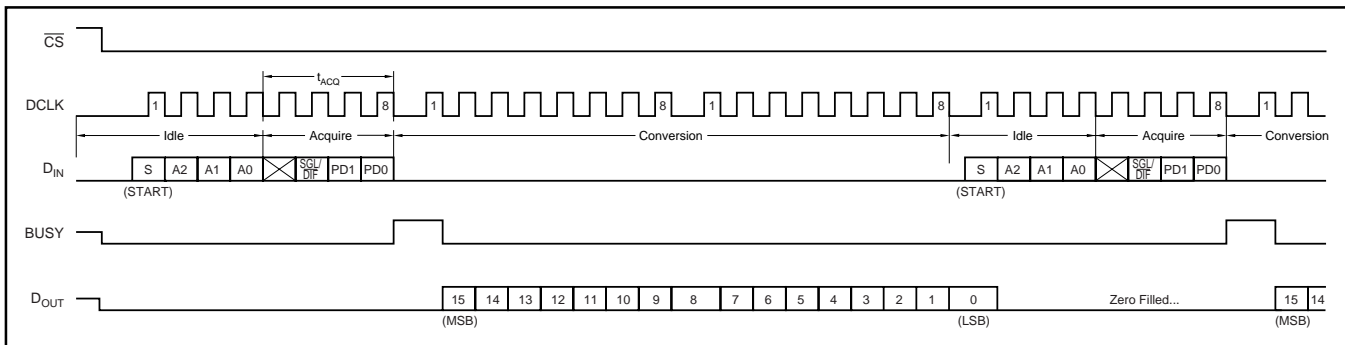

FIGURE 3. Conversion Timing, 24-Clocks per Conversion, 8-Bit Bus Interface. No DCLK Delay Required with Dedicated Serial Port.

The first eight clock cycles are used to provide the control byte via the D<sub>IN</sub> pin. When the converter has enough information about the following conversion to set the input multiplexer appropriately, it enters the acquisition (sample) mode. After four more clock cycles, the control byte is complete and the converter enters the conversion mode. At this point, the input sample-and-hold goes into the Hold mode. The next sixteen clock cycles accomplish the actual A/D conversion.

### Control Byte

See Figure 3 for placement and order of the control bits within the control byte. Tables III and IV give detailed information about these bits. The first bit, the “S” bit, must always be HIGH and indicates the start of the control byte. The ADS8344 will ignore inputs on the D<sub>IN</sub> pin until the START bit is detected. The next three bits (A2-A0) select the active input channel or channels of the input multiplexer (see Tables I and II and Figure 2).

BIT 7 (MSB)	BIT 6	BIT 5	BIT 4	BIT 3	BIT 2	BIT 1	BIT 0 (LSB)
S	A2	A1	A0	—	SGL/DIF	PD1	PD0

TABLE III. Order of the Control Bits in the Control Byte.

BIT	NAME	DESCRIPTION
7	S	Start Bit. Control byte starts with first HIGH bit on D <sub>IN</sub> .
6 - 4	A2 - A0	Channel Select Bits. Along with the SGL/DIF bit, these bits control the setting of the multiplexer input, see Tables I and II.
2	SGL/DIF	Single-Ended/Differential Select Bit. Along with bits A2 - A0, this bit controls the setting of the multiplexer input, see Tables I and II.
1 - 0	PD1 - PD0	Power-Down Mode Select Bits. See Table V for details.

TABLE IV. Descriptions of the Control Bits within the Control Byte.

The SGL/DIF-bit controls the multiplexer input mode: either in single-ended mode, where the selected input channel is referenced to the COM pin, or in differential mode, where the two selected inputs provide a differential input. See Tables I and II and Figure 2 for more information. The last two bits (PD1 - PD0) select the power-down mode and Clock mode, as shown in Table V. If both PD1 and PD0 are

HIGH, the device is always powered up. If both PD1 and PD0 are LOW, the device enters a power-down mode between conversions. When a new conversion is initiated, the device will resume normal operation instantly—no delay is needed to allow the device to power up and the very first conversion will be valid.

PD1	PD0	DESCRIPTION
0	0	Power-down between conversions. When each conversion is finished, the converter enters a low-power mode. At the start of the next conversion, the device instantly powers up to full power. There is no need for additional delays to assure full operation and the very first conversion is valid.
1	0	Selects Internal Clock Mode.
0	1	Reserved for Future Use.
1	1	No power-down between conversions, device always powered. Selects external clock mode.

TABLE V. Power-Down Selection.

### Clock Modes

The ADS8344 can be used with an external serial clock or an internal clock to perform the successive-approximation conversion. In both clock modes, the external clock shifts data in and out of the device. Internal clock mode is selected when PD1 is HIGH and PD0 is LOW.

If the user decides to switch from one clock mode to the other, an extra conversion cycle will be required before the ADS8344 can switch to the new mode. The extra cycle is required because the PD0 and PD1 control bits need to be written to the ADS8344 prior to the change in clock modes.

When power is first applied to the ADS8344, the user must set the desired clock mode. It can be set by writing PD1 = 1 and PD0 = 0 for internal clock mode or PD1 = 1 and PD0 = 1 for external clock mode. After enabling the required clock mode, only then should the ADS8344 be set to power-down between conversions (i.e., PD1 = PD0 = 0). The ADS8344 maintains the clock mode it was in prior to entering the power-down modes.

### External Clock Mode

In external clock mode, the external clock not only shifts data in and out of the ADS8344, it also controls the A/D conversion steps. BUSY will go HIGH for one clock period after the last bit of the control byte is shifted in. Successive-approximation bit decisions are made and appear at D<sub>OUT</sub> on each of the next 16 DCLK falling edges (see Figure 3). Figure 4 shows the BUSY timing in external clock mode.

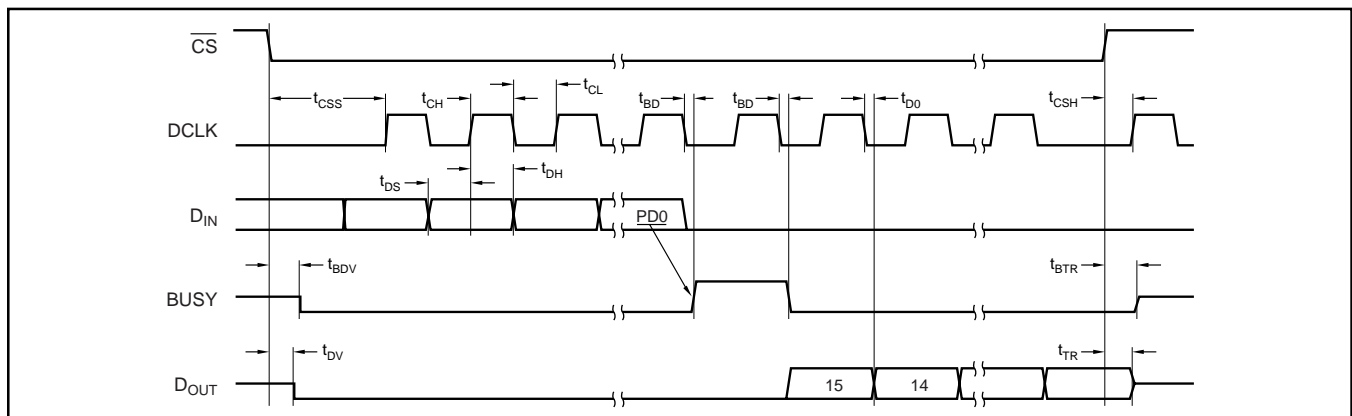

FIGURE 4. Detailed Timing Diagram.

Since one clock cycle of the serial clock is consumed with BUSY going HIGH (while the MSB decision is being made), 16 additional clocks must be given to clock out all 16 bits of data; thus, one conversion takes a minimum of 25 clock cycles to fully read the data. Since most microprocessors communicate in 8-bit transfers, this means that an additional transfer must be made to capture the LSB.

There are two ways of handling this requirement. One is where the beginning of the next control byte appears at the same time the LSB is being clocked out of the ADS8344 (see Figure 3). This method allows for maximum throughput and 24 clock cycles per conversion.

The other method is shown in Figure 5, which uses 32 clock cycles per conversion; the last seven clock cycles simply shift out zeros on the D<sub>OUT</sub> line. BUSY and D<sub>OUT</sub> go into a high-impedance state when  $\overline{CS}$  goes HIGH; after the next  $\overline{CS}$  falling edge, BUSY will go LOW.

### Internal Clock Mode

In internal clock mode, the ADS8344 generates its own conversion clock internally. This relieves the microprocessor from having to generate the SAR conversion clock and allows the conversion result to be read back at the processor's convenience, at any clock rate from 0MHz to 2.0MHz. BUSY goes LOW at the start of a conversion and then returns HIGH when the conversion is complete. During the conversion, BUSY will remain LOW for a maximum of 8 $\mu$ s. Also, during the conversion, DCLK should remain LOW to achieve the best noise performance. The conversion result is stored in an internal register; the data may be clocked out of this register any time after the conversion is complete.

If  $\overline{CS}$  is LOW when BUSY goes LOW following a conversion, the next falling edge of the external serial clock will write out the MSB on the D<sub>OUT</sub> line. The remaining bits (D14-D0) will be clocked out on each successive clock cycle following the MSB. If  $\overline{CS}$  is HIGH when BUSY goes LOW then the D<sub>OUT</sub> line will remain in tri-state until  $\overline{CS}$  goes LOW, as shown in Figure 6.  $\overline{CS}$  does not need to remain LOW once a conversion has started. Note that BUSY is not tri-stated when  $\overline{CS}$  goes HIGH in internal clock mode.

Data can be shifted in and out of the ADS8344 at clock rates exceeding 2.4MHz, provided that the minimum acquisition time  $t_{ACQ}$  is kept above 1.7 $\mu$ s.

### Digital Timing

Figure 4 and Tables VI and VII provide detailed timing for the digital interface of the ADS8344.

SYMBOL	DESCRIPTION	MIN	TYP	MAX	UNITS
$t_{ACQ}$	Acquisition Time	1.5			$\mu$ s
$t_{DS}$	D <sub>IN</sub> Valid Prior to DCLK Rising	100			ns
$t_{DH}$	D <sub>IN</sub> Hold After DCLK HIGH	10			ns
$t_{DO}$	DCLK Falling to D <sub>OUT</sub> Valid			200	ns
$t_{DV}$	$\overline{CS}$ Falling to D <sub>OUT</sub> Enabled			200	ns
$t_{DR}$	$\overline{CS}$ Rising to D <sub>OUT</sub> Disabled			200	ns
$t_{CSS}$	$\overline{CS}$ Falling to First DCLK Rising	100			ns
$t_{CSH}$	$\overline{CS}$ Rising to DCLK Ignored	0			ns
$t_{CH}$	DCLK HIGH	200			ns
$t_{CL}$	DCLK LOW	200			ns
$t_{BD}$	DCLK Falling to BUSY Rising			200	ns
$t_{BDV}$	$\overline{CS}$ Falling to BUSY Enabled			200	ns
$t_{BTR}$	$\overline{CS}$ Rising to BUSY Disabled			200	ns

TABLE VI. Timing Specifications ( $+V_{CC} = +2.7V$  to  $3.6V$ ,  $T_A = -40^\circ C$  to  $+85^\circ C$ ,  $C_{LOAD} = 50pF$ ).

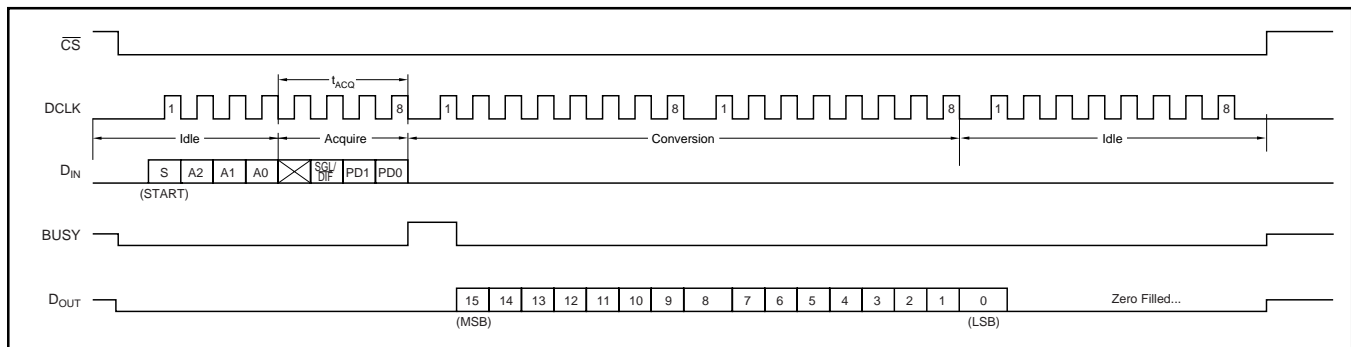

FIGURE 5. External Clock Mode, 32 Clocks Per Conversion.

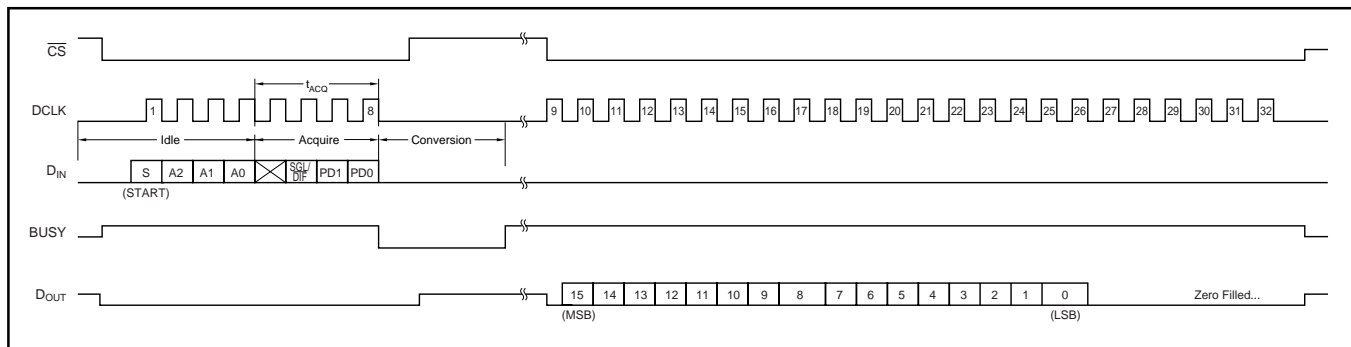

FIGURE 6. Internal Clock Mode Timing.

SYMBOL	DESCRIPTION	MIN	TYP	MAX	UNITS
$t_{ACQ}$	Acquisition Time	1.7			$\mu$ s
$t_{DS}$	$D_{IN}$ Valid Prior to DCLK Rising	50			ns
$t_{DH}$	$D_{IN}$ Hold After DCLK HIGH	10			ns
$t_{DO}$	DCLK Falling to $D_{OUT}$ Valid			100	ns
$t_{DV}$	$\overline{CS}$ Falling to $D_{OUT}$ Enabled			70	ns
$t_{TR}$	$\overline{CS}$ Rising to $D_{OUT}$ Disabled			70	ns
$t_{CSS}$	$\overline{CS}$ Falling to First DCLK Rising	50			ns
$t_{CSH}$	$\overline{CS}$ Rising to DCLK Ignored	0			ns
$t_{CH}$	DCLK HIGH	150			ns
$t_{CL}$	DCLK LOW	150			ns
$t_{BD}$	DCLK Falling to BUSY Rising			100	ns
$t_{BDV}$	$\overline{CS}$ Falling to BUSY Enabled			70	ns
$t_{BTR}$	$\overline{CS}$ Rising to BUSY Disabled			70	ns

TABLE VII. Timing Specifications ( $+V_{CC} = +4.75V$  to  $+5.25V$ ,  $T_A = -40^\circ C$  to  $+85^\circ C$ ,  $C_{LOAD} = 50pF$ ).

## Data Format

The ADS8344 output data is in straight binary format, as shown in Figure 7. This figure shows the ideal output code for the given input voltage and does not include the effects of offset, gain, or noise.

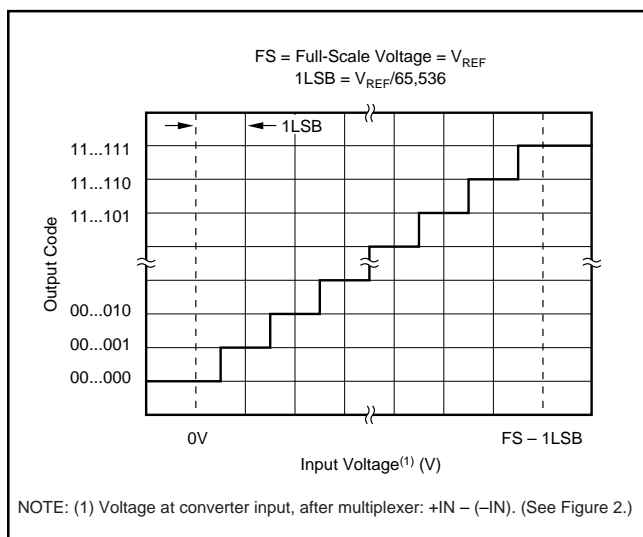

FIGURE 7. Ideal Input Voltages and Output Codes.

## POWER DISSIPATION

There are three power modes for the ADS8344: full-power (PD1 - PD0 = 11B), auto power-down (PD1 - PD0 = 00B), and shutdown ( $\overline{SHDN}$  LOW). The effects of these modes varies depending on how the ADS8344 is being operated. For example, at full conversion rate and 24-clocks per conversion, there is very little difference between full-power mode and auto power-down; a shutdown will not lower power dissipation.

When operating at full-speed and 24-clocks per conversion (see Figure 3), the ADS8344 spends most of its time acquiring or converting. There is little time for auto power-down, assuming that this mode is active. Thus, the difference between full-power mode and auto power-down is negligible. If the conversion rate is decreased by simply slowing the frequency of the DCLK input, the two modes

remain approximately equal. However, if the DCLK frequency is kept at the maximum rate during a conversion, but conversions are simply done less often, then the difference between the two modes is dramatic. In the latter case, the converter spends an increasing percentage of its time in power-down mode (assuming the auto power-down mode is active).

If DCLK is active and  $\overline{CS}$  is LOW while the ADS8344 is in auto power-down mode, the device will continue to dissipate some power in the digital logic. The power can be reduced to a minimum by keeping  $\overline{CS}$  HIGH.

Operating the ADS8344 in auto power-down mode will result in the lowest power dissipation, and there is no conversion time “penalty” on power-up. The very first conversion will be valid.  $\overline{SHDN}$  can be used to force an immediate power-down.

## NOISE

The noise floor of the ADS8344 itself is extremely low, as shown in Figures 8 thru 11, and is much lower than competing A/D converters. The ADS8344 was tested at both 5V and 2.7V, and in both the internal and external clock modes. A low-level DC input was applied to the analog-input pins and the converter was put through 5,000 conversions. The digital output of the A/D converter will vary in output code due to the internal noise of the ADS8344. This is true for all 16-bit SAR-type A/D converters. Using a histogram to plot the output codes, the distribution should appear bell-shaped with the peak of the bell curve representing the nominal code for the input value. The  $\pm 1\sigma$ ,  $\pm 2\sigma$ , and  $\pm 3\sigma$  distributions will represent the 68.3%, 95.5%, and 99.7%, respectively, of all codes. The transition noise can be calculated by dividing the number of codes measured by 6 and this will yield the  $\pm 3\sigma$  distribution, or 99.7%, of all codes. Statistically, up to 3 codes could fall outside the distribution when executing 1,000 conversions. The ADS8344, with  $< 3$  output codes for the  $\pm 3\sigma$  distribution, will yield a  $< \pm 0.5LSB$  transition noise at 5V operation. Remember, to achieve this low-noise performance, the peak-to-peak noise of the input signal and reference must be  $< 50\mu V$ .

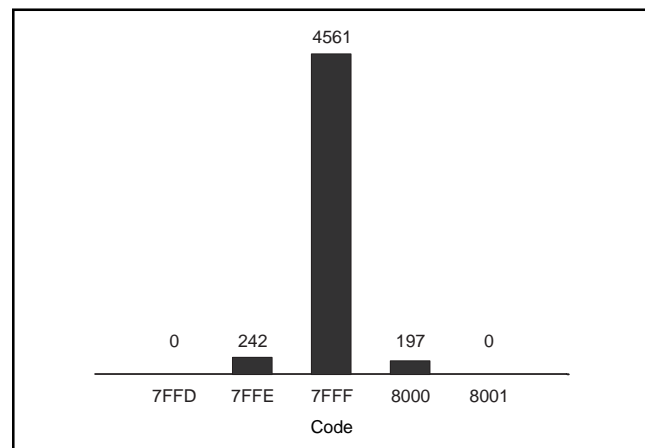

FIGURE 8. Histogram of 5,000 Conversions of a DC Input at the Code Transition, 5V operation external clock mode.

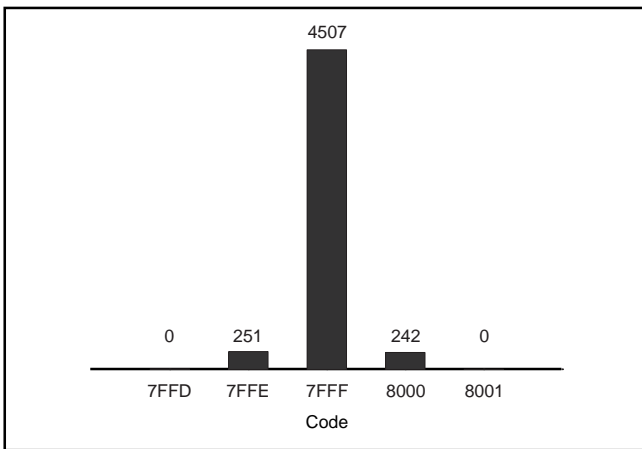

FIGURE 9. Histogram of 5,000 Conversions of a DC Input at the Code Center, 5V operation internal clock mode.

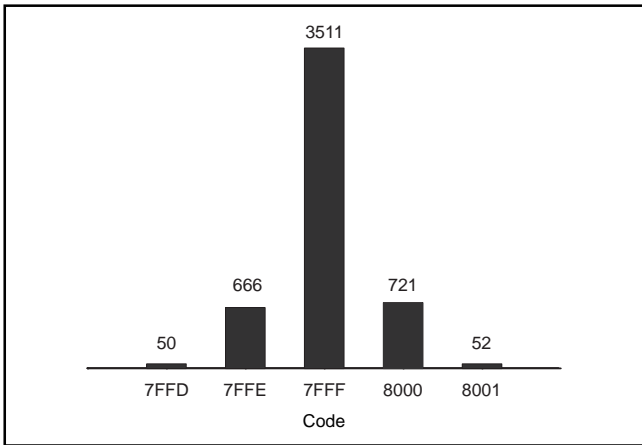

FIGURE 10. Histogram of 5,000 Conversions of a DC Input at the Code Transition, 2.7V operation external clock mode.

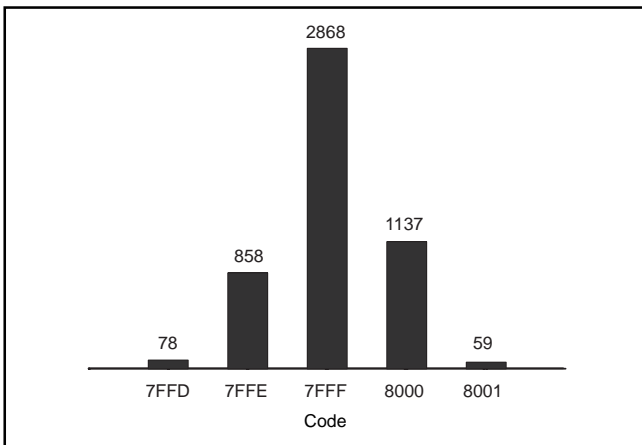

FIGURE 11. Histogram of 5,000 Conversions of a DC Input at the Code Center, 2.7V operation internal clock mode.

## AVERAGING

The noise of the A/D converter can be compensated by averaging the digital codes. By averaging conversion results, transition noise will be reduced by a factor of  $1/\sqrt{n}$ , where  $n$  is the number of averages. For example, averaging 4 conver-

sion results will reduce the transition noise by 1/2 to  $\pm 0.25$ LSBs. Averaging should only be used for input signals with frequencies near DC.

For AC signals, a digital filter can be used to low-pass filter and decimate the output codes. This works in a similar manner to averaging: for every decimation by 2, the signal-to-noise ratio will improve 3dB.

## LAYOUT

For optimum performance, care should be taken with the physical layout of the ADS8344 circuitry. This is particularly true if the reference voltage is LOW and/or the conversion rate is HIGH.

The basic SAR architecture is sensitive to glitches or sudden changes on the power supply, reference, ground connections, and digital inputs that occur just prior to latching the output of the analog comparator. Thus, during any single conversion for an  $n$ -bit SAR converter, there are  $n$  “windows” in which large external transient voltages can easily affect the conversion result. Such glitches might originate from switching power supplies, nearby digital logic, and high-power devices. The degree of error in the digital output depends on the reference voltage, layout, and the exact timing of the external event. The error can change if the external event changes in time with respect to the DCLK input.

With this in mind, power to the ADS8344 should be clean and well bypassed. A  $0.1\mu\text{F}$  ceramic bypass capacitor should be placed as close to the device as possible. In addition, a  $1\mu\text{F}$  to  $10\mu\text{F}$  capacitor and a  $5\Omega$  or  $10\Omega$  series resistor may be used to low-pass filter a noisy supply.

The reference should be similarly bypassed with a  $0.1\mu\text{F}$  capacitor. Again, a series resistor and large capacitor can be used to low-pass filter the reference voltage. If the reference voltage originates from an op amp, make sure that it can drive the bypass capacitor without oscillation (the series resistor can help in this case). The ADS8344 draws very little current from the reference on average, but it does place larger demands on the reference circuitry over short periods of time (on each rising edge of DCLK during a conversion).

The ADS8344 architecture offers no inherent rejection of noise or voltage variation in regards to the reference input. This is of particular concern when the reference input is tied to the power supply. Any noise and ripple from the supply will appear directly in the digital results. While high-frequency noise can be filtered out as discussed in the previous paragraph, voltage variation due to line frequency (50Hz or 60Hz) can be difficult to remove.

The GND pin should be connected to a clean ground point. In many cases, this will be the “analog” ground. Avoid connections that are too near the grounding point of a microcontroller or digital signal processor. If needed, run a ground trace directly from the converter to the power-supply entry point. The ideal layout will include an analog ground plane dedicated to the converter and associated analog circuitry.

## Revision History

DATE	REVISION	PAGE	SECTION	DESCRIPTION
9/06	E	2	Package/Ordering Info	Added quantity to last column.
		4	Electrical Characteristics	Fixed typo. Changed +2.7V Gain Error minimum value (for EB, NB grade) from $\pm 0.0024$ to $\pm 0.024$ .

NOTE: Page numbers for previous revisions may differ from page numbers in the current version.

**PACKAGING INFORMATION**

Orderable Device	Status (1)	Package Type	Package Drawing	Pins	Package Qty	Eco Plan (2)	Lead/Ball Finish (6)	MSL Peak Temp (3)	Op Temp (°C)	Device Marking (4/5)	Samples
ADS8344E	ACTIVE	SSOP	DBQ	20	50	Green (RoHS & no Sb/Br)	CU NIPDAU	Level-2-260C-1 YEAR	-40 to 85	ADS8344E	<a href="#">Samples</a>
ADS8344E/2K5	ACTIVE	SSOP	DBQ	20	2500	Green (RoHS & no Sb/Br)	CU NIPDAU	Level-3-260C-168 HR	-40 to 85	ADS8344E	<a href="#">Samples</a>
ADS8344E/2K5G4	ACTIVE	SSOP	DBQ	20	2500	Green (RoHS & no Sb/Br)	CU NIPDAU	Level-3-260C-168 HR	-40 to 85	ADS8344E	<a href="#">Samples</a>
ADS8344EB	ACTIVE	SSOP	DBQ	20	50	Green (RoHS & no Sb/Br)	CU NIPDAU	Level-3-260C-168 HR	-40 to 85	ADS8344E B	<a href="#">Samples</a>
ADS8344EB/2K5	ACTIVE	SSOP	DBQ	20	2500	Green (RoHS & no Sb/Br)	CU NIPDAU	Level-3-260C-168 HR	-40 to 85	ADS8344E B	<a href="#">Samples</a>
ADS8344EBG4	ACTIVE	SSOP	DBQ	20	50	Green (RoHS & no Sb/Br)	CU NIPDAU	Level-3-260C-168 HR	-40 to 85	ADS8344E B	<a href="#">Samples</a>
ADS8344EG4	ACTIVE	SSOP	DBQ	20	50	Green (RoHS & no Sb/Br)	CU NIPDAU	Level-2-260C-1 YEAR	-40 to 85	ADS8344E	<a href="#">Samples</a>
ADS8344N	ACTIVE	SSOP	DB	20	70	Green (RoHS & no Sb/Br)	CU NIPDAU	Level-2-260C-1 YEAR	-40 to 85	ADS8344N B	<a href="#">Samples</a>
ADS8344N/1K	ACTIVE	SSOP	DB	20	1000	Green (RoHS & no Sb/Br)	CU NIPDAU	Level-2-260C-1 YEAR	-40 to 85	ADS8344N B	<a href="#">Samples</a>
ADS8344N/1KG4	ACTIVE	SSOP	DB	20	1000	Green (RoHS & no Sb/Br)	CU NIPDAU	Level-2-260C-1 YEAR	-40 to 85	ADS8344N B	<a href="#">Samples</a>
ADS8344NB	ACTIVE	SSOP	DB	20	70	Green (RoHS & no Sb/Br)	CU NIPDAU	Level-2-260C-1 YEAR	-40 to 85	ADS8344N B	<a href="#">Samples</a>
ADS8344NB/1K	ACTIVE	SSOP	DB	20	1000	Green (RoHS & no Sb/Br)	CU NIPDAU	Level-2-260C-1 YEAR	-40 to 85	ADS8344N B	<a href="#">Samples</a>
ADS8344NB/1KG4	ACTIVE	SSOP	DB	20	1000	Green (RoHS & no Sb/Br)	CU NIPDAU	Level-2-260C-1 YEAR	-40 to 85	ADS8344N B	<a href="#">Samples</a>
ADS8344NBG4	ACTIVE	SSOP	DB	20	70	Green (RoHS & no Sb/Br)	CU NIPDAU	Level-2-260C-1 YEAR	-40 to 85	ADS8344N B	<a href="#">Samples</a>
ADS8344NG4	ACTIVE	SSOP	DB	20	70	Green (RoHS & no Sb/Br)	CU NIPDAU	Level-2-260C-1 YEAR	-40 to 85	ADS8344N B	<a href="#">Samples</a>

(1) The marketing status values are defined as follows:

**ACTIVE:** Product device recommended for new designs.

**LIFEBUY:** TI has announced that the device will be discontinued, and a lifetime-buy period is in effect.

**NRND:** Not recommended for new designs. Device is in production to support existing customers, but TI does not recommend using this part in a new design.

---

**PREVIEW:** Device has been announced but is not in production. Samples may or may not be available.

**OBSELETE:** TI has discontinued the production of the device.

<sup>(2)</sup> **RoHS:** TI defines "RoHS" to mean semiconductor products that are compliant with the current EU RoHS requirements for all 10 RoHS substances, including the requirement that RoHS substance do not exceed 0.1% by weight in homogeneous materials. Where designed to be soldered at high temperatures, "RoHS" products are suitable for use in specified lead-free processes. TI may reference these types of products as "Pb-Free".

**RoHS Exempt:** TI defines "RoHS Exempt" to mean products that contain lead but are compliant with EU RoHS pursuant to a specific EU RoHS exemption.

**Green:** TI defines "Green" to mean the content of Chlorine (Cl) and Bromine (Br) based flame retardants meet JS709B low halogen requirements of  $\leq 1000$ ppm threshold. Antimony trioxide based flame retardants must also meet the  $\leq 1000$ ppm threshold requirement.

<sup>(3)</sup> MSL, Peak Temp. - The Moisture Sensitivity Level rating according to the JEDEC industry standard classifications, and peak solder temperature.

<sup>(4)</sup> There may be additional marking, which relates to the logo, the lot trace code information, or the environmental category on the device.

<sup>(5)</sup> Multiple Device Markings will be inside parentheses. Only one Device Marking contained in parentheses and separated by a "~" will appear on a device. If a line is indented then it is a continuation of the previous line and the two combined represent the entire Device Marking for that device.

<sup>(6)</sup> Lead/Ball Finish - Orderable Devices may have multiple material finish options. Finish options are separated by a vertical ruled line. Lead/Ball Finish values may wrap to two lines if the finish value exceeds the maximum column width.

**Important Information and Disclaimer:** The information provided on this page represents TI's knowledge and belief as of the date that it is provided. TI bases its knowledge and belief on information provided by third parties, and makes no representation or warranty as to the accuracy of such information. Efforts are underway to better integrate information from third parties. TI has taken and continues to take reasonable steps to provide representative and accurate information but may not have conducted destructive testing or chemical analysis on incoming materials and chemicals. TI and TI suppliers consider certain information to be proprietary, and thus CAS numbers and other limited information may not be available for release.

In no event shall TI's liability arising out of such information exceed the total purchase price of the TI part(s) at issue in this document sold by TI to Customer on an annual basis.

**TAPE AND REEL INFORMATION**

**QUADRANT ASSIGNMENTS FOR PIN 1 ORIENTATION IN TAPE**

\*All dimensions are nominal

Device	Package Type	Package Drawing	Pins	SPQ	Reel Diameter (mm)	Reel Width W1 (mm)	A0 (mm)	B0 (mm)	K0 (mm)	P1 (mm)	W (mm)	Pin1 Quadrant
ADS8344E/2K5	SSOP	DBQ	20	2500	330.0	16.4	6.5	9.0	2.1	8.0	16.0	Q1
ADS8344EB/2K5	SSOP	DBQ	20	2500	330.0	16.4	6.5	9.0	2.1	8.0	16.0	Q1
ADS8344N/1K	SSOP	DB	20	1000	330.0	16.4	8.2	7.5	2.5	12.0	16.0	Q1
ADS8344NB/1K	SSOP	DB	20	1000	330.0	16.4	8.2	7.5	2.5	12.0	16.0	Q1

**TAPE AND REEL BOX DIMENSIONS**

\*All dimensions are nominal

Device	Package Type	Package Drawing	Pins	SPQ	Length (mm)	Width (mm)	Height (mm)
ADS8344E/2K5	SSOP	DBQ	20	2500	367.0	367.0	38.0
ADS8344EB/2K5	SSOP	DBQ	20	2500	367.0	367.0	38.0
ADS8344N/1K	SSOP	DB	20	1000	367.0	367.0	38.0
ADS8344NB/1K	SSOP	DB	20	1000	367.0	367.0	38.0

DBQ (R-PDSO-G20)

PLASTIC SMALL-OUTLINE PACKAGE

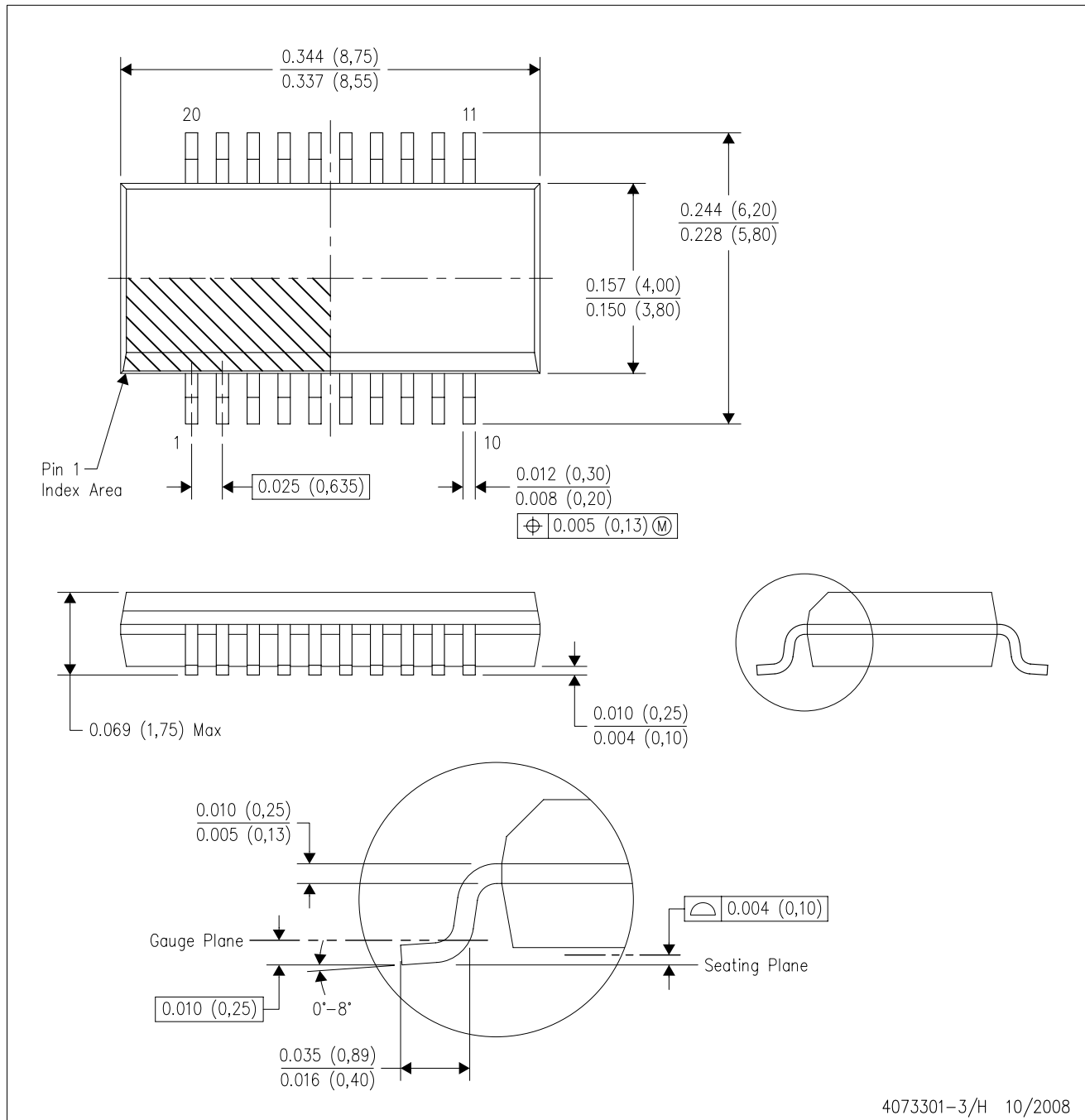

- NOTES:
- A. All linear dimensions are in inches (millimeters).
  - B. This drawing is subject to change without notice.
  - C. Body dimensions do not include mold flash or protrusion not to exceed 0.006 (0,15) per side.
  - D. Falls within JEDEC MO-137 variation AD.

DBQ (R-PDSO-G20)

PLASTIC SMALL OUTLINE PACKAGE

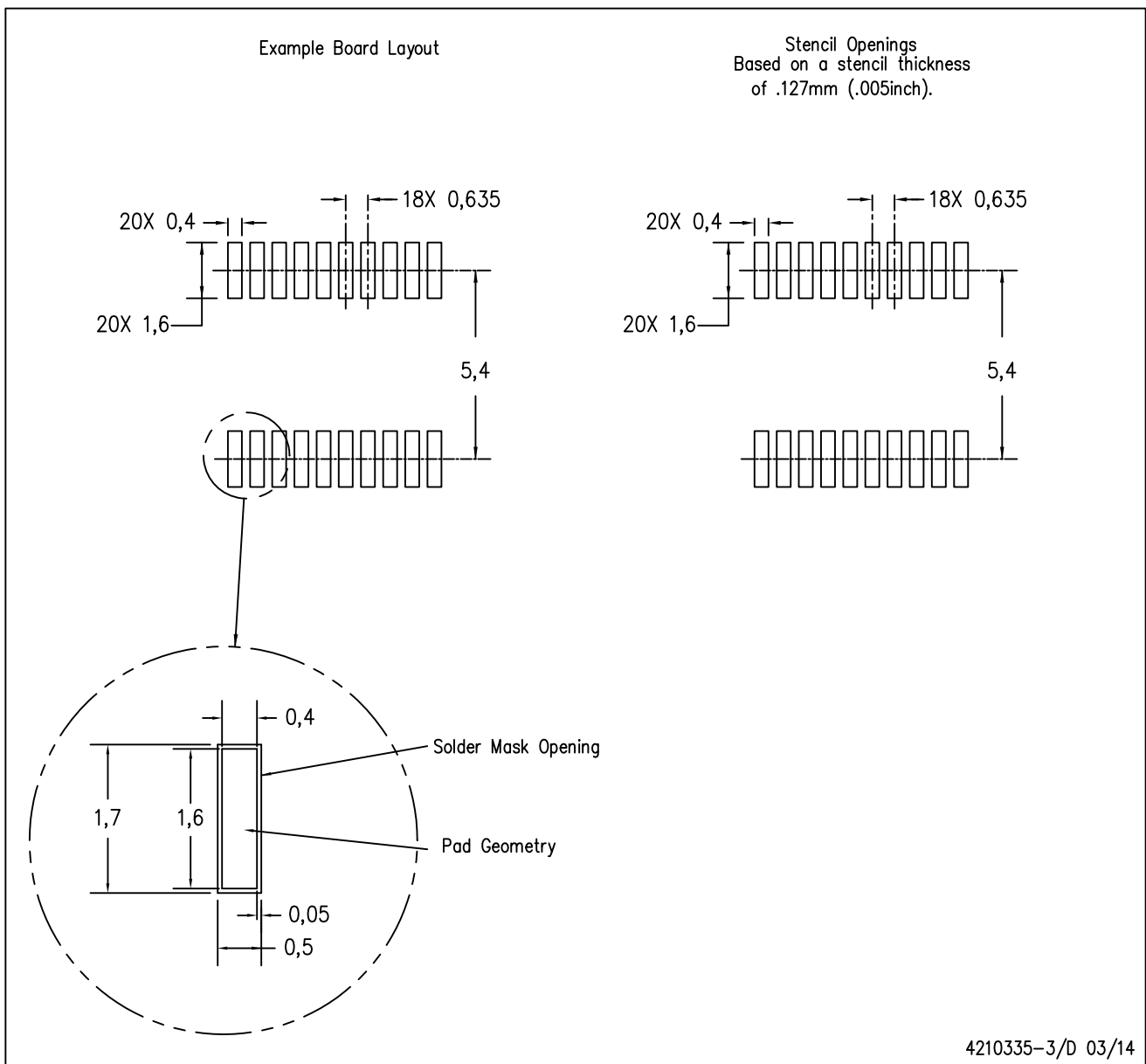

- NOTES:
- A. All linear dimensions are in millimeters.
  - B. This drawing is subject to change without notice.
  - C. Publication IPC-7351 is recommended for alternate designs.
  - D. Laser cutting apertures with trapezoidal walls and also rounding corners will offer better paste release. Customers should contact their board assembly site for stencil design recommendations. Example stencil design based on a 50% volumetric metal load solder paste. Refer to IPC-7525 for other stencil recommendations.

# DB0020A



# PACKAGE OUTLINE

## TSSOP - 2 mm max height

SMALL OUTLINE PACKAGE



4214851/A 12/2017

### NOTES:

1. All linear dimensions are in millimeters. Any dimensions in parenthesis are for reference only. Dimensioning and tolerancing per ASME Y14.5M.
2. This drawing is subject to change without notice.
3. This dimension does not include mold flash, protrusions, or gate burrs. Mold flash, protrusions, or gate burrs shall not exceed 0.15 mm per side.
4. This dimension does not include interlead flash. Interlead flash shall not exceed 0.25 mm per side.
5. Reference JEDEC registration MO-150.

# EXAMPLE BOARD LAYOUT

DB0020A

TSSOP - 2 mm max height

SMALL OUTLINE PACKAGE



LAND PATTERN EXAMPLE  
EXPOSED METAL SHOWN  
SCALE: 10X



SOLDER MASK DETAILS

4214851/A 12/2017

NOTES: (continued)

- 6. Publication IPC-7351 may have alternate designs.
- 7. Solder mask tolerances between and around signal pads can vary based on board fabrication site.

# EXAMPLE STENCIL DESIGN

DB0020A

TSSOP - 2 mm max height

SMALL OUTLINE PACKAGE



SOLDER PASTE EXAMPLE  
BASED ON 0.125 mm THICK STENCIL  
SCALE: 10X

4214851/A 12/2017

NOTES: (continued)

8. Laser cutting apertures with trapezoidal walls and rounded corners may offer better paste release. IPC-7525 may have alternate design recommendations.
9. Board assembly site may have different recommendations for stencil design.

## IMPORTANT NOTICE AND DISCLAIMER

TI PROVIDES TECHNICAL AND RELIABILITY DATA (INCLUDING DATASHEETS), DESIGN RESOURCES (INCLUDING REFERENCE DESIGNS), APPLICATION OR OTHER DESIGN ADVICE, WEB TOOLS, SAFETY INFORMATION, AND OTHER RESOURCES "AS IS" AND WITH ALL FAULTS, AND DISCLAIMS ALL WARRANTIES, EXPRESS AND IMPLIED, INCLUDING WITHOUT LIMITATION ANY IMPLIED WARRANTIES OF MERCHANTABILITY, FITNESS FOR A PARTICULAR PURPOSE OR NON-INFRINGEMENT OF THIRD PARTY INTELLECTUAL PROPERTY RIGHTS.

These resources are intended for skilled developers designing with TI products. You are solely responsible for (1) selecting the appropriate TI products for your application, (2) designing, validating and testing your application, and (3) ensuring your application meets applicable standards, and any other safety, security, or other requirements. These resources are subject to change without notice. TI grants you permission to use these resources only for development of an application that uses the TI products described in the resource. Other reproduction and display of these resources is prohibited. No license is granted to any other TI intellectual property right or to any third party intellectual property right. TI disclaims responsibility for, and you will fully indemnify TI and its representatives against, any claims, damages, costs, losses, and liabilities arising out of your use of these resources.

TI's products are provided subject to TI's Terms of Sale ([www.ti.com/legal/termsofsale.html](http://www.ti.com/legal/termsofsale.html)) or other applicable terms available either on [ti.com](http://ti.com) or provided in conjunction with such TI products. TI's provision of these resources does not expand or otherwise alter TI's applicable warranties or warranty disclaimers for TI products.

Mailing Address: Texas Instruments, Post Office Box 655303, Dallas, Texas 75265  
Copyright © 2019, Texas Instruments Incorporated

## Looking for pricing, stock, or lifecycle information?

Click below to explore more details on WIN SOURCE:

 [View ADS8344E/2K5G4 on WIN SOURCE](#)

 [Texas Instruments](#) Information

## Optimize Your Supply Chain with WIN SOURCE Solutions

-  Global Sourcing Solution
-  Obsolete Management
-  Cost Control Management
-  Shortage Management
-  Alternative Solution
-  Excess Inventory Management