



**THE DATASHEET OF  
LM4040CEM3-2.5/NOPB**



## LM4040-N/-Q1 Precision Micropower Shunt Voltage Reference

### 1 Features

- SOT-23 AEC Q-100 Grades 1 and 3 Available
- Small Packages: SOT-23, TO-92, and SC70
- No Output Capacitor Required
- Tolerates Capacitive Loads
- Fixed Reverse Breakdown Voltages of 2.048 V, 2.5 V, 3 V, 4.096 V, 5 V, 8.192 V, and 10 V
- Key Specifications (2.5-V LM4040-N)
  - Output Voltage Tolerance (A Grade, 25°C):  $\pm 0.1\%$  (Maximum)
  - Low Output Noise (10 Hz to 10 kHz):  $35 \mu\text{V}_{\text{rms}}$  (Typical)
  - Wide Operating Current Range: 60  $\mu\text{A}$  to 15 mA
  - Industrial Temperature Range:  $-40^\circ\text{C}$  to  $+85^\circ\text{C}$
  - Extended Temperature Range:  $-40^\circ\text{C}$  to  $+125^\circ\text{C}$
  - Low Temperature Coefficient: 100 ppm/ $^\circ\text{C}$  (Maximum)

### 2 Applications

- Portable, Battery-Powered Equipment
- Data Acquisition Systems
- Instrumentation
- Process Controls
- Energy Management
- Product Testing
- Automotives
- Precision Audio Components

### 3 Description

Ideal for space-critical applications, the LM4040-N precision voltage reference is available in the sub-miniature SC70 and SOT-23 surface-mount package. The advanced design of the LM4040-N eliminates the need for an external stabilizing capacitor while ensuring stability with any capacitive load, thus making the LM4040-N easy to use. Further reducing design effort is the availability of several fixed reverse breakdown voltages: 2.048 V, 2.5 V, 3 V, 4.096 V, 5 V, 8.192 V, and 10 V. The minimum operating current increases from 60  $\mu\text{A}$  for the 2.5-V LM4040-N to 100  $\mu\text{A}$  for the 10-V LM4040-N. All versions have a maximum operating current of 15 mA.

The LM4040-N uses a fuse and Zener-zap reverse breakdown voltage trim during wafer sort to ensure that the prime parts have an accuracy of better than  $\pm 0.1\%$  (A grade) at 25°C. Bandgap reference temperature drift curvature correction and low dynamic impedance ensure stable reverse breakdown voltage accuracy over a wide range of operating temperatures and currents.

Also available is the LM4041-N with two reverse breakdown voltage versions: adjustable and 1.2 V. See the LM4041-N data sheet ([SNOS641](#)).

#### Device Information<sup>(1)</sup>

PART NUMBER	PACKAGE	BODY SIZE (NOM)
LM4040-N	TO-92 (3)	4.30 mm × 4.30 mm
	SC70 (5)	2.00 mm × 1.25 mm
	SOT-23 (3)	2.92 mm × 1.30 mm
LM4040-N-Q1	SOT-23 (3)	2.92 mm × 1.30 mm

(1) For all available packages, see the orderable addendum at the end of the data sheet.

#### Shunt Reference Application Schematic



## Table of Contents

<b>1</b>	<b>Features</b> .....	<b>1</b>			
<b>2</b>	<b>Applications</b> .....	<b>1</b>			
<b>3</b>	<b>Description</b> .....	<b>1</b>			
<b>4</b>	<b>Revision History</b> .....	<b>3</b>			
<b>5</b>	<b>Pin Configuration and Functions</b> .....	<b>4</b>			
<b>6</b>	<b>Specifications</b> .....	<b>5</b>			
6.1	Absolute Maximum Ratings .....	5			
6.2	ESD Ratings .....	5			
6.3	Recommended Operating Conditions .....	6			
6.4	Thermal Information .....	6			
6.5	Electrical Characteristics: 2-V LM4040-N $V_R$ Tolerance Grades 'A' And 'B'; Temperature Grade 'I' .....	7			
6.6	Electrical Characteristics: 2-V LM4040-N $V_R$ Tolerance Grades 'C', 'D', And 'E'; Temperature Grade 'I' .....	8			
6.7	Electrical Characteristics: 2-V LM4040-N $V_R$ Tolerance Grades 'C', 'D', And 'E'; Temperature Grade 'E' .....	10			
6.8	Electrical Characteristics: 2.5-V LM4040-N $V_R$ Tolerance Grades 'A' And 'B'; Temperature Grade 'I' (AEC Grade 3) .....	11			
6.9	Electrical Characteristics: 2.5-V LM4040-N $V_R$ Tolerance Grades 'C', 'D', and 'E'; Temperature Grade 'I' (AEC Grade 3) .....	13			
6.10	Electrical Characteristics: 2.5-V LM4040-N $V_R$ Tolerance Grades 'C', 'D', And 'E'; Temperature Grade 'E' (AEC Grade 1) .....	15			
6.11	Electrical Characteristics: 3-V LM4040-N $V_R$ Tolerance Grades 'A' And 'B'; Temperature Grade 'I' .....	17			
6.12	Electrical Characteristics: 3-V LM4040-N $V_R$ Tolerance Grades 'C', 'D', And 'E'; Temperature Grade 'I' .....	18			
6.13	Electrical Characteristics: 3-V LM4040-N $V_R$ Tolerance Grades 'C', 'D', And 'E'; Temperature Grade 'E' .....	20			
6.14	Electrical Characteristics: 4.1-V LM4040-N $V_R$ Tolerance Grades 'A' And 'B'; Temperature Grade 'I' .....	21			
6.15	Electrical Characteristics: 4.1-V LM4040-N $V_R$ Tolerance Grades 'C' and 'D'; Temperature Grade 'I' .....	22			
6.16	Electrical Characteristics: 5-V LM4040-N $V_R$ Tolerance Grades 'A' And 'B'; Temperature Grade 'I' .....	23			
6.17	Electrical Characteristics: 5-V LM4040-N $V_R$ Tolerance Grades 'C' And 'D'; Temperature Grade 'I' .....	24			
6.18	Electrical Characteristics: 5-V LM4040-N $V_R$ Tolerance Grades 'C' And 'D'; Temperature Grade 'E' .....	26			
6.19	Electrical Characteristics: 8.2-V LM4040-N $V_R$ Tolerance Grades 'A' And 'B'; Temperature Grade 'I' .....	27			
6.20	Electrical Characteristics: 8.2-V Lm4040-N $V_R$ Tolerance Grades 'C' And 'D'; Temperature Grade 'I' .....	28			
6.21	Electrical Characteristics: 10-V LM4040-N $V_R$ Tolerance Grades 'A' And 'B'; Temperature Grade 'I' .....	29			
6.22	Electrical Characteristics: 10-V LM4040-N $V_R$ Tolerance Grades 'C' And 'D'; Temperature Grade 'I' .....	30			
6.23	Typical Characteristics .....	31			
<b>7</b>	<b>Parameter Measurement Information</b> .....	<b>32</b>			
<b>8</b>	<b>Detailed Description</b> .....	<b>33</b>			
8.1	Overview .....	33			
8.2	Functional Block Diagram .....	33			
8.3	Feature Description .....	33			
8.4	Device Functional Modes .....	33			
<b>9</b>	<b>Application and Implementation</b> .....	<b>34</b>			
9.1	Application Information .....	34			
9.2	Typical Applications .....	34			
<b>10</b>	<b>Power Supply Recommendations</b> .....	<b>41</b>			
<b>11</b>	<b>Layout</b> .....	<b>41</b>			
11.1	Layout Guidelines .....	41			
11.2	Layout Example .....	41			
<b>12</b>	<b>Device and Documentation Support</b> .....	<b>42</b>			
12.1	Documentation Support .....	42			
12.2	Related Links .....	42			
12.3	Community Resources .....	42			
12.4	Trademarks .....	42			
12.5	Electrostatic Discharge Caution .....	42			
12.6	Glossary .....	42			
<b>13</b>	<b>Mechanical, Packaging, And Orderable Information</b> .....	<b>42</b>			
13.1	SOT-23 and SC70 Package Marking Information .....	42			

## 4 Revision History

NOTE: Page numbers for previous revisions may differ from page numbers in the current version.

<b>Changes from Revision J (August 2015) to Revision K</b>	<b>Page</b>
<ul style="list-style-type: none"> <li>• Updated pinout diagrams ..... 4</li> </ul>	4
<hr/>	
<b>Changes from Revision I (April 2015) to Revision J</b>	<b>Page</b>
<ul style="list-style-type: none"> <li>• Added <i>ESD Ratings</i> table, <i>Feature Description</i> section, <i>Device Functional Modes</i> section, <i>Application and Implementation</i> section, <i>Power Supply Recommendations</i> section, <i>Layout</i> section, <i>Device and Documentation Support</i> section, and <i>Mechanical, Packaging, and Orderable Information</i> section ..... 1</li> </ul>	1
<hr/>	
<b>Changes from Revision H (April 2013) to Revision I</b>	<b>Page</b>
<ul style="list-style-type: none"> <li>• Added some of the latest inclusions from new TI formatting and made available of the automotive grade for the SOT-23 package..... 1</li> </ul>	1
<hr/>	
<b>Changes from Revision G (July 2012) to Revision H</b>	<b>Page</b>
<ul style="list-style-type: none"> <li>• Changed layout of National Data Sheet to TI format ..... 1</li> </ul>	1

## 5 Pin Configuration and Functions



### Pin Functions

NAME	PIN			I/O	DESCRIPTION
	SOT-23	TO-92	SC70		
Anode	2	1	1	O	Anode pin, normally grounded
Cathode	1	2	3	I/O	Shunt Current/Output Voltage
NC	3 <sup>(1)</sup>	—	2 <sup>(2)</sup>	—	Must float or connect to anode
NC	—	3	4, 5	—	No connect

(1) This pin must be left floating or connected to pin 2.

(2) This pin must be left floating or connected to pin 1.

## 6 Specifications

### 6.1 Absolute Maximum Ratings

over operating free-air temperature range (unless otherwise noted)<sup>(1)(2)</sup>

		MIN	MAX	UNIT
Reverse current			20	mA
Forward current			10	mA
Power dissipation ( $T_A = 25^\circ\text{C}$ ) <sup>(3)</sup>	SOT-23 (M3) package		306	mW
	TO-92 (Z) package		550	mW
	SC70 (M7) package		241	mW
Soldering temperature <sup>(4)</sup>	SOT-23 (M3) Package Peak Reflow (30 sec)		260	°C
	TO-92 (Z) Package Soldering (10 sec)		260	°C
	SC70 (M7) Package Peak Reflow (30 sec)		260	°C
Storage temperature		-65	150	°C

- (1) Stresses beyond those listed under *Absolute Maximum Ratings* may cause permanent damage to the device. These are stress ratings only, which do not imply functional operation of the device at these or any other conditions beyond those indicated under *Recommended Operating Conditions*. Exposure to absolute-maximum-rated conditions for extended periods may affect device reliability.
- (2) If Military/Aerospace specified devices are required, please contact the Texas Instruments Sales Office/ Distributors for availability and specifications.
- (3) The maximum power dissipation must be derated at elevated temperatures and is dictated by  $T_{Jmax}$  (maximum junction temperature),  $R_{\theta JA}$  (junction to ambient thermal resistance), and  $T_A$  (ambient temperature). The maximum allowable power dissipation at any temperature is  $PD_{max} = (T_{Jmax} - T_A)/R_{\theta JA}$  or the number given in the *Absolute Maximum Ratings*, whichever is lower. For the LM4040-N,  $T_{Jmax} = 125^\circ\text{C}$ , and the typical thermal resistance ( $R_{\theta JA}$ ), when board mounted, is  $326^\circ\text{C/W}$  for the SOT-23 package, and  $180^\circ\text{C/W}$  with 0.4" lead length and  $170^\circ\text{C/W}$  with 0.125" lead length for the TO-92 package and  $415^\circ\text{C/W}$  for the SC70 Package.
- (4) For definitions of Peak Reflow Temperatures for Surface Mount devices, see the T1 *Absolute Maximum Ratings for Soldering Application Report* (SNOA549).

### 6.2 ESD Ratings

		VALUE	UNIT
$V_{(ESD)}$ Electrostatic discharge	Human-body model (HBM), per ANSI/ESDA/JEDEC JS-001 <sup>(1)</sup>	±2000	V
	Charged-device model (CDM), per JEDEC specification JESD22-C101 <sup>(2)</sup>	±200	

- (1) JEDEC document JEP155 states that 500-V HBM allows safe manufacturing with a standard ESD control process.
- (2) JEDEC document JEP157 states that 250-V CDM allows safe manufacturing with a standard ESD control process.

### 6.3 Recommended Operating Conditions

 over operating free-air temperature range (unless otherwise noted)<sup>(1)(2)</sup>

		MIN	MAX	UNIT
Temperature ( $T_{\min} \leq T_A \leq T_{\max}$ )	Industrial Temperature	$-40^{\circ}\text{C} \leq T_A \leq 85$		$^{\circ}\text{C}$
	Extended Temperature	$-40 \leq T_A \leq 125^{\circ}\text{C}$		$^{\circ}\text{C}$
Reverse Current	LM4040-N-2.0	60	15	$\mu\text{A}$ to mA
	LM4040-N-2.5	60	15	$\mu\text{A}$ to mA
	LM4040-N-3.0	62	15	$\mu\text{A}$ to mA
	LM4040-N-4.1	68	15	$\mu\text{A}$ to mA
	LM4040-N-5.0	74	15	$\mu\text{A}$ to mA
	LM4040-N-8.2	91	15	$\mu\text{A}$ to mA
	LM4040-N-10.0	100	15	$\mu\text{A}$ to mA

- (1) *Absolute Maximum Ratings* indicate limits beyond which damage to the device may occur. *Recommended Operating Conditions* indicate conditions for which the device is functional, but do not ensure specific performance limits. For ensured specifications and test conditions, see the *Electrical Characteristics*. The ensured specifications apply only for the test conditions listed. Some performance characteristics may degrade when the device is not operated under the listed test conditions.
- (2) The maximum power dissipation must be derated at elevated temperatures and is dictated by  $T_{\text{Jmax}}$  (maximum junction temperature),  $R_{\theta\text{JA}}$  (junction to ambient thermal resistance), and  $T_A$  (ambient temperature). The maximum allowable power dissipation at any temperature is  $\text{PD}_{\text{max}} = (T_{\text{Jmax}} - T_A)/R_{\theta\text{JA}}$  or the number given in the Absolute Maximum Ratings, whichever is lower. For the LM4040-N,  $T_{\text{Jmax}} = 125^{\circ}\text{C}$ , and the typical thermal resistance ( $R_{\theta\text{JA}}$ ), when board mounted, is  $326^{\circ}\text{C}/\text{W}$  for the SOT-23 package, and  $180^{\circ}\text{C}/\text{W}$  with 0.4" lead length and  $170^{\circ}\text{C}/\text{W}$  with 0.125" lead length for the TO-92 package and  $415^{\circ}\text{C}/\text{W}$  for the SC70 package.

### 6.4 Thermal Information

THERMAL METRIC <sup>(1)</sup>		LM4040-N/LM4040-N-Q1			UNIT
		DBZ (SOT-23)	LP (TO-92)	DCK (SC70)	
		3 PINS	3 PINS	5 PINS	
$R_{\theta\text{JA}}$	Junction-to-ambient thermal resistance	291.9	166	267	$^{\circ}\text{C}/\text{W}$
$R_{\theta\text{JC(top)}}$	Junction-to-case (top) thermal resistance	114.3	88.2	95.6	$^{\circ}\text{C}/\text{W}$
$R_{\theta\text{JB}}$	Junction-to-board thermal resistance	62.3	145.2	48.1	$^{\circ}\text{C}/\text{W}$
$\psi_{\text{JT}}$	Junction-to-top characterization parameter	7.4	32.5	2.4	$^{\circ}\text{C}/\text{W}$
$\psi_{\text{JB}}$	Junction-to-board characterization parameter	61	N/A	47.3	$^{\circ}\text{C}/\text{W}$
$R_{\theta\text{JC(bot)}}$	Junction-to-case (bottom) thermal resistance	N/A	N/A	N/A	$^{\circ}\text{C}/\text{W}$

- (1) For more information about traditional and new thermal metrics, see the *Semiconductor and IC Package Thermal Metrics* application report, [SPRA953](#).

## 6.5 Electrical Characteristics: 2-V LM4040-N $V_R$ Tolerance Grades 'A' And 'B'; Temperature Grade 'I'

all other limits  $T_A = T_J = 25^\circ\text{C}$ . The grades A and B designate initial Reverse Breakdown Voltage tolerances of  $\pm 0.1\%$  and  $\pm 0.2\%$ , respectively.

PARAMETER		TEST CONDITIONS		MIN <sup>(1)</sup>	TYP	MAX <sup>(1)</sup>	UNIT	
$V_R$	Reverse Breakdown Voltage	$I_R = 100\ \mu\text{A}$			2.048		V	
	Reverse Breakdown Voltage Tolerance <sup>(2)</sup>	$I_R = 100\ \mu\text{A}$	LM4040AIM3 LM4040AIZ			$\pm 2$	mV	
			LM4040BIM3 LM4040BIZ LM4040BIM7			$\pm 4.1$	mV	
			LM4040AIM3 LM4040AIZ	$T_A = T_J = T_{\text{MIN}}$ to $T_{\text{MAX}}$			$\pm 15$	mV
			LM4040BIM3 LM4040BIZ LM4040BIM7	$T_A = T_J = T_{\text{MIN}}$ to $T_{\text{MAX}}$			$\pm 17$	mV
$I_{\text{RMIN}}$	Minimum Operating Current		$T_A = T_J = 25^\circ\text{C}$		45	60	$\mu\text{A}$	
			$T_A = T_J = T_{\text{MIN}}$ to $T_{\text{MAX}}$			65		
$\Delta V_R/\Delta T$	Average Reverse Breakdown Voltage Temperature Coefficient <sup>(2)</sup>	$I_R = 10\ \text{mA}$			$\pm 20$		ppm/ $^\circ\text{C}$	
		$I_R = 1\ \text{mA}$	$T_A = T_J = 25^\circ\text{C}$		$\pm 15$		ppm/ $^\circ\text{C}$	
			$T_A = T_J = T_{\text{MIN}}$ to $T_{\text{MAX}}$			$\pm 100$		
$I_R = 100\ \mu\text{A}$				$\pm 15$		ppm/ $^\circ\text{C}$		
$\Delta V_R/\Delta I_R$	Reverse Breakdown Voltage Change with Operating Current Change <sup>(3)</sup>	$I_{\text{RMIN}} \leq I_R \leq 1\ \text{mA}$	$T_A = T_J = 25^\circ\text{C}$		0.3	0.8	mV	
			$T_A = T_J = T_{\text{MIN}}$ to $T_{\text{MAX}}$			1		
		$1\ \text{mA} \leq I_R \leq 15\ \text{mA}$	$T_A = T_J = 25^\circ\text{C}$		2.5	6	mV	
			$T_A = T_J = T_{\text{MIN}}$ to $T_{\text{MAX}}$			8		
$Z_R$	Reverse Dynamic Impedance	$I_R = 1\ \text{mA}$ , $f = 120\ \text{Hz}$ , $I_{\text{AC}} = 0.1 I_R$			0.3	0.8	$\Omega$	
$e_N$	Wideband Noise	$I_R = 100\ \mu\text{A}$ $10\ \text{Hz} \leq f \leq 10\ \text{kHz}$			35		$\mu\text{V}_{\text{rms}}$	
$\Delta V_R$	Reverse Breakdown Voltage Long Term Stability	$t = 1000\ \text{hrs}$ $T = 25^\circ\text{C} \pm 0.1^\circ\text{C}$ $I_R = 100\ \mu\text{A}$			120		ppm	
$V_{\text{HYST}}$	Thermal Hysteresis <sup>(4)</sup>	$\Delta T = -40^\circ\text{C}$ to $125^\circ\text{C}$			0.08%			

- Limits are 100% production tested at  $25^\circ\text{C}$ . Limits over temperature are ensured through correlation using Statistical Quality Control (SQC) methods. The limits are used to calculate AOQL.
- The overtemperature limit for Reverse Breakdown Voltage Tolerance is defined as the room temperature Reverse Breakdown Voltage Tolerance  $\pm[(\Delta V_R/\Delta T)(\text{max}\Delta T)(V_R)]$ . Where,  $\Delta V_R/\Delta T$  is the  $V_R$  temperature coefficient,  $\text{max}\Delta T$  is the maximum difference in temperature from the reference point of  $25^\circ\text{C}$  to  $T_{\text{MIN}}$  or  $T_{\text{MAX}}$ , and  $V_R$  is the reverse breakdown voltage. The total overtemperature tolerance for the different grades in the industrial temperature range where  $\text{max}\Delta T = 65^\circ\text{C}$  is shown below:  
 A-grade:  $\pm 0.75\% = \pm 0.1\% \pm 100\ \text{ppm}/^\circ\text{C} \times 65^\circ\text{C}$   
 B-grade:  $\pm 0.85\% = \pm 0.2\% \pm 100\ \text{ppm}/^\circ\text{C} \times 65^\circ\text{C}$   
 C-grade:  $\pm 1.15\% = \pm 0.5\% \pm 100\ \text{ppm}/^\circ\text{C} \times 65^\circ\text{C}$   
 D-grade:  $\pm 1.98\% = \pm 1.0\% \pm 150\ \text{ppm}/^\circ\text{C} \times 65^\circ\text{C}$   
 E-grade:  $\pm 2.98\% = \pm 2.0\% \pm 150\ \text{ppm}/^\circ\text{C} \times 65^\circ\text{C}$   
 The total overtemperature tolerance for the different grades in the extended temperature range where  $\text{max}\Delta T = 100^\circ\text{C}$  is shown below:  
 C-grade:  $\pm 1.5\% = \pm 0.5\% \pm 100\ \text{ppm}/^\circ\text{C} \times 100^\circ\text{C}$   
 D-grade:  $\pm 2.5\% = \pm 1.0\% \pm 150\ \text{ppm}/^\circ\text{C} \times 100^\circ\text{C}$   
 E-grade:  $\pm 3.5\% = \pm 2.0\% \pm 150\ \text{ppm}/^\circ\text{C} \times 100^\circ\text{C}$   
 Therefore, as an example, the A-grade 2.5-V LM4040-N has an overtemperature Reverse Breakdown Voltage tolerance of  $\pm 2.5\ \text{V} \times 0.75\% = \pm 19\ \text{mV}$ .
- Load regulation is measured on pulse basis from no load to the specified load current. Output changes due to die temperature change must be taken into account separately.
- Thermal hysteresis is defined as the difference in voltage measured at  $25^\circ\text{C}$  after cycling to temperature  $-40^\circ\text{C}$  and the  $25^\circ\text{C}$  measurement after cycling to temperature  $125^\circ\text{C}$ .

## 6.6 Electrical Characteristics: 2-V LM4040-N $V_R$ Tolerance Grades 'C', 'D', And 'E'; Temperature Grade 'I'

all other limits  $T_A = T_J = 25^\circ\text{C}$ . The grades C, D and E designate initial Reverse Breakdown Voltage tolerances of  $\pm 0.5\%$ ,  $\pm 1\%$  and  $\pm 2\%$ , respectively.

PARAMETER		TEST CONDITIONS		MIN <sup>(1)</sup>	TYP <sup>(2)</sup>	MAX <sup>(1)</sup>	UNIT		
$V_R$	Reverse Breakdown Voltage	$I_R = 100 \mu\text{A}$			2.048		V		
	Reverse Breakdown Voltage Tolerance <sup>(3)</sup>	$I_R = 100 \mu\text{A}$	LM4040CIM3	$T_A = T_J = 25^\circ\text{C}$			$\pm 10$	mV	
			LM4040CIZ	$T_A = T_J = T_{\text{MIN}}$ to $T_{\text{MAX}}$			$\pm 23$		
			LM4040CIM7						
			LM4040DIM3	$T_A = T_J = 25^\circ\text{C}$			$\pm 20$		
			LM4040DIZ	$T_A = T_J = T_{\text{MIN}}$ to $T_{\text{MAX}}$			$\pm 40$		
LM4040DIM7									
$I_{\text{RMIN}}$	Minimum Operating Current		LM4040CIM3	$T_A = T_J = 25^\circ\text{C}$		45	60	$\mu\text{A}$	
			LM4040CIZ	$T_A = T_J = T_{\text{MIN}}$ to $T_{\text{MAX}}$					65
			LM4040CIM7						
			LM4040DIM3	$T_A = T_J = 25^\circ\text{C}$			45		65
			LM4040DIZ	$T_A = T_J = T_{\text{MIN}}$ to $T_{\text{MAX}}$					70
			LM4040DIM7						
$\Delta V_R/\Delta T$	Average Reverse Breakdown Voltage Temperature Coefficient <sup>(3)</sup>	$I_R = 10 \text{ mA}$					$\pm 20$	ppm/ $^\circ\text{C}$	
		$I_R = 1 \text{ mA}$	LM4040CIM3	$T_A = T_J = 25^\circ\text{C}$			$\pm 15$		
			LM4040CIZ	$T_A = T_J = T_{\text{MIN}}$ to $T_{\text{MAX}}$					$\pm 100$
			LM4040CIM7						
			LM4040DIM3	$T_A = T_J = 25^\circ\text{C}$			$\pm 15$		
			LM4040DIZ	$T_A = T_J = T_{\text{MIN}}$ to $T_{\text{MAX}}$					$\pm 150$
		LM4040DIM7							
		$I_R = 100 \mu\text{A}$	LM4040EIZ	$T_A = T_J = 25^\circ\text{C}$			$\pm 15$		
			LM4040EIM7	$T_A = T_J = T_{\text{MIN}}$ to $T_{\text{MAX}}$			$\pm 150$		
							$\pm 15$		

- (1) Limits are 100% production tested at  $25^\circ\text{C}$ . Limits over temperature are ensured through correlation using Statistical Quality Control (SQC) methods. The limits are used to calculate AOQL.
- (2) Typicals are at  $T_J = 25^\circ\text{C}$  and represent most likely parametric norm.
- (3) The overtemperature limit for Reverse Breakdown Voltage Tolerance is defined as the room temperature Reverse Breakdown Voltage Tolerance  $\pm[(\Delta V_R/\Delta T)(\text{max}\Delta T)(V_R)]$ . Where,  $\Delta V_R/\Delta T$  is the  $V_R$  temperature coefficient,  $\text{max}\Delta T$  is the maximum difference in temperature from the reference point of  $25^\circ\text{C}$  to  $T_{\text{MIN}}$  or  $T_{\text{MAX}}$ , and  $V_R$  is the reverse breakdown voltage. The total overtemperature tolerance for the different grades in the industrial temperature range where  $\text{max}\Delta T = 65^\circ\text{C}$  is shown below:  
 A-grade:  $\pm 0.75\% = \pm 0.1\% \pm 100 \text{ ppm}/^\circ\text{C} \times 65^\circ\text{C}$   
 B-grade:  $\pm 0.85\% = \pm 0.2\% \pm 100 \text{ ppm}/^\circ\text{C} \times 65^\circ\text{C}$   
 C-grade:  $\pm 1.15\% = \pm 0.5\% \pm 100 \text{ ppm}/^\circ\text{C} \times 65^\circ\text{C}$   
 D-grade:  $\pm 1.98\% = \pm 1.0\% \pm 150 \text{ ppm}/^\circ\text{C} \times 65^\circ\text{C}$   
 E-grade:  $\pm 2.98\% = \pm 2.0\% \pm 150 \text{ ppm}/^\circ\text{C} \times 65^\circ\text{C}$   
 The total overtemperature tolerance for the different grades in the extended temperature range where  $\text{max}\Delta T = 100^\circ\text{C}$  is shown below:  
 C-grade:  $\pm 1.5\% = \pm 0.5\% \pm 100 \text{ ppm}/^\circ\text{C} \times 100^\circ\text{C}$   
 D-grade:  $\pm 2.5\% = \pm 1.0\% \pm 150 \text{ ppm}/^\circ\text{C} \times 100^\circ\text{C}$   
 E-grade:  $\pm 3.5\% = \pm 2.0\% \pm 150 \text{ ppm}/^\circ\text{C} \times 100^\circ\text{C}$   
 Therefore, as an example, the A-grade 2.5-V LM4040-N has an overtemperature Reverse Breakdown Voltage tolerance of  $\pm 2.5V \times 0.75\% = \pm 19 \text{ mV}$ .

**Electrical Characteristics: 2-V LM4040-N  $V_R$  Tolerance Grades 'C', 'D', And 'E'; Temperature Grade 'I' (continued)**

all other limits  $T_A = T_J = 25^\circ\text{C}$ . The grades C, D and E designate initial Reverse Breakdown Voltage tolerances of  $\pm 0.5\%$ ,  $\pm 1\%$  and  $\pm 2\%$ , respectively.

PARAMETER	TEST CONDITIONS		MIN <sup>(1)</sup>	TYP <sup>(2)</sup>	MAX <sup>(1)</sup>	UNIT
$\Delta V_R/\Delta I_R$ Reverse Breakdown Voltage Change with Operating Current Change <sup>(4)</sup>	$I_{RMIN} \leq I_R \leq 1 \text{ mA}$	LM4040CIM3 LM4040CIZ LM4040CIM7	$T_A = T_J = 25^\circ\text{C}$	0.3	0.8	mV
			$T_A = T_J = T_{MIN} \text{ to } T_{MAX}$		1	
		LM4040DIM3 LM4040DIZ LM4040DIM7	$T_A = T_J = 25^\circ\text{C}$	0.3	1	
			$T_A = T_J = T_{MIN} \text{ to } T_{MAX}$		1.2	
		LM4040EIZ LM4040EIM7	$T_A = T_J = 25^\circ\text{C}$	0.3	1	
			$T_A = T_J = T_{MIN} \text{ to } T_{MAX}$		1.2	
	$1 \text{ mA} \leq I_R \leq 15 \text{ mA}$	LM4040CIM3 LM4040CIZ LM4040CIM7	$T_A = T_J = 25^\circ\text{C}$	2.5	6	
			$T_A = T_J = T_{MIN} \text{ to } T_{MAX}$		8	
		LM4040DIM3 LM4040DIZ LM4040DIM7	$T_A = T_J = 25^\circ\text{C}$	2.5	8	
			$T_A = T_J = T_{MIN} \text{ to } T_{MAX}$		10	
		LM4040EIZ LM4040EIM7	$T_A = T_J = 25^\circ\text{C}$	2.5	8	
			$T_A = T_J = T_{MIN} \text{ to } T_{MAX}$		10	
$Z_R$ Reverse Dynamic Impedance	$I_R = 1 \text{ mA}, f = 120 \text{ Hz}$ $I_{AC} = 0.1 I_R$	LM4040CIM3 LM4040CIZ LM4040CIM7		0.3	0.9	$\Omega$
		LM4040DIM3 LM4040DIZ LM4040DIM7		0.3	1.1	
		LM4040EIZ LM4040EIM7		0.3	1.1	
$e_N$ Wideband Noise	$I_R = 100 \mu\text{A}$ $10 \text{ Hz} \leq f \leq 10 \text{ kHz}$			35		$\mu\text{V}_{rms}$
$\Delta V_R$ Reverse Breakdown Voltage Long Term Stability	$t = 1000 \text{ hrs}$ $T = 25^\circ\text{C} \pm 0.1^\circ\text{C}$ $I_R = 100 \mu\text{A}$			120		ppm
$V_{HYST}$ Thermal Hysteresis <sup>(5)</sup>	$\Delta T = -40^\circ\text{C} \text{ to } 125^\circ\text{C}$			0.08%		

(4) Load regulation is measured on pulse basis from no load to the specified load current. Output changes due to die temperature change must be taken into account separately.

(5) Thermal hysteresis is defined as the difference in voltage measured at  $25^\circ\text{C}$  after cycling to temperature  $-40^\circ\text{C}$  and the  $25^\circ\text{C}$  measurement after cycling to temperature  $125^\circ\text{C}$ .

## 6.7 Electrical Characteristics: 2-V LM4040-N $V_R$ Tolerance Grades 'C', 'D', And 'E'; Temperature Grade 'E'

all other limits  $T_A = T_J = 25^\circ\text{C}$ . The grades C, D and E designate initial Reverse Breakdown Voltage tolerances of  $\pm 0.5\%$ ,  $\pm 1\%$  and  $\pm 2\%$ , respectively.

PARAMETER		TEST CONDITIONS		MIN <sup>(1)</sup>	TYP <sup>(2)</sup>	MAX <sup>(1)</sup>	UNIT		
$V_R$	Reverse Breakdown Voltage	$I_R = 100 \mu\text{A}$			2.048		V		
	Reverse Breakdown Voltage Tolerance <sup>(3)</sup>	$I_R = 100 \mu\text{A}$	LM4040CEM3	$T_A = T_J = 25^\circ\text{C}$			$\pm 10$	mV	
				$T_A = T_J = T_{\text{MIN}}$ to $T_{\text{MAX}}$			$\pm 30$		
			LM4040DEM3	$T_A = T_J = 25^\circ\text{C}$			$\pm 20$		
				$T_A = T_J = T_{\text{MIN}}$ to $T_{\text{MAX}}$			$\pm 50$		
			LM4040EEM3	$T_A = T_J = 25^\circ\text{C}$			$\pm 41$		
$T_A = T_J = T_{\text{MIN}}$ to $T_{\text{MAX}}$						$\pm 70$			
$I_{\text{RMIN}}$	Minimum Operating Current		LM4040CEM3	$T_A = T_J = 25^\circ\text{C}$		45	60	$\mu\text{A}$	
				$T_A = T_J = T_{\text{MIN}}$ to $T_{\text{MAX}}$			68		
			LM4040DEM3	$T_A = T_J = 25^\circ\text{C}$			45		65
				$T_A = T_J = T_{\text{MIN}}$ to $T_{\text{MAX}}$			73		
			LM4040EEM3	$T_A = T_J = 25^\circ\text{C}$			45		65
				$T_A = T_J = T_{\text{MIN}}$ to $T_{\text{MAX}}$			73		
$\Delta V_R/\Delta T$	Average Reverse Breakdown Voltage Temperature Coefficient <sup>(3)</sup>	$I_R = 10 \text{ mA}$	LM4040CEM3	$T_A = T_J = 25^\circ\text{C}$		$\pm 20$	ppm/ $^\circ\text{C}$		
				$T_A = T_J = T_{\text{MIN}}$ to $T_{\text{MAX}}$				$\pm 15$	
		$I_R = 1 \text{ mA}$	LM4040DEM3	$T_A = T_J = 25^\circ\text{C}$				$\pm 100$	
				$T_A = T_J = T_{\text{MIN}}$ to $T_{\text{MAX}}$				$\pm 15$	
		LM4040EEM3	$T_A = T_J = 25^\circ\text{C}$			$\pm 150$			
			$T_A = T_J = T_{\text{MIN}}$ to $T_{\text{MAX}}$			$\pm 15$			
		$I_R = 100 \mu\text{A}$		$T_A = T_J = 25^\circ\text{C}$				$\pm 15$	
				$T_A = T_J = T_{\text{MIN}}$ to $T_{\text{MAX}}$				$\pm 15$	
$\Delta V_R/\Delta I_R$	Reverse Breakdown Voltage Change with Operating Current Change <sup>(4)</sup>	$I_{\text{RMIN}} \leq I_R \leq 1 \text{ mA}$	LM4040CEM3	$T_A = T_J = 25^\circ\text{C}$		0.3	0.8	mV	
				$T_A = T_J = T_{\text{MIN}}$ to $T_{\text{MAX}}$			1		
			LM4040DEM3	$T_A = T_J = 25^\circ\text{C}$			0.3		1
				$T_A = T_J = T_{\text{MIN}}$ to $T_{\text{MAX}}$			1.2		
			LM4040EEM3	$T_A = T_J = 25^\circ\text{C}$			0.3		1
				$T_A = T_J = T_{\text{MIN}}$ to $T_{\text{MAX}}$			1.2		
		$1 \text{ mA} \leq I_R \leq 15 \text{ mA}$	LM4040CEM3	$T_A = T_J = 25^\circ\text{C}$			2.5		6
				$T_A = T_J = T_{\text{MIN}}$ to $T_{\text{MAX}}$			8		
			LM4040DEM3	$T_A = T_J = 25^\circ\text{C}$			2.5		8
				$T_A = T_J = T_{\text{MIN}}$ to $T_{\text{MAX}}$			10		
			LM4040EEM3	$T_A = T_J = 25^\circ\text{C}$			2.5		8
				$T_A = T_J = T_{\text{MIN}}$ to $T_{\text{MAX}}$			10		

- Limits are 100% production tested at  $25^\circ\text{C}$ . Limits over temperature are ensured through correlation using Statistical Quality Control (SQC) methods. The limits are used to calculate AOQL.
- Typicals are at  $T_J = 25^\circ\text{C}$  and represent most likely parametric norm.
- The overtemperature limit for Reverse Breakdown Voltage Tolerance is defined as the room temperature Reverse Breakdown Voltage Tolerance  $\pm[(\Delta V_R/\Delta T)(\text{max}\Delta T)(V_R)]$ . Where,  $\Delta V_R/\Delta T$  is the  $V_R$  temperature coefficient,  $\text{max}\Delta T$  is the maximum difference in temperature from the reference point of  $25^\circ\text{C}$  to  $T_{\text{MIN}}$  or  $T_{\text{MAX}}$ , and  $V_R$  is the reverse breakdown voltage. The total overtemperature tolerance for the different grades in the industrial temperature range where  $\text{max}\Delta T = 65^\circ\text{C}$  is shown below:  
 A-grade:  $\pm 0.75\% = \pm 0.1\% \pm 100 \text{ ppm}/^\circ\text{C} \times 65^\circ\text{C}$   
 B-grade:  $\pm 0.85\% = \pm 0.2\% \pm 100 \text{ ppm}/^\circ\text{C} \times 65^\circ\text{C}$   
 C-grade:  $\pm 1.15\% = \pm 0.5\% \pm 100 \text{ ppm}/^\circ\text{C} \times 65^\circ\text{C}$   
 D-grade:  $\pm 1.98\% = \pm 1.0\% \pm 150 \text{ ppm}/^\circ\text{C} \times 65^\circ\text{C}$   
 E-grade:  $\pm 2.98\% = \pm 2.0\% \pm 150 \text{ ppm}/^\circ\text{C} \times 65^\circ\text{C}$   
 The total overtemperature tolerance for the different grades in the extended temperature range where  $\text{max}\Delta T = 100^\circ\text{C}$  is shown below:  
 C-grade:  $\pm 1.5\% = \pm 0.5\% \pm 100 \text{ ppm}/^\circ\text{C} \times 100^\circ\text{C}$   
 D-grade:  $\pm 2.5\% = \pm 1.0\% \pm 150 \text{ ppm}/^\circ\text{C} \times 100^\circ\text{C}$   
 E-grade:  $\pm 3.5\% = \pm 2.0\% \pm 150 \text{ ppm}/^\circ\text{C} \times 100^\circ\text{C}$   
 Therefore, as an example, the A-grade 2.5-V LM4040-N has an overtemperature Reverse Breakdown Voltage tolerance of  $\pm 2.5\text{V} \times 0.75\% = \pm 19 \text{ mV}$ .
- Load regulation is measured on pulse basis from no load to the specified load current. Output changes due to die temperature change must be taken into account separately.

### Electrical Characteristics: 2-V LM4040-N $V_R$ Tolerance Grades 'C', 'D', And 'E'; Temperature Grade 'E' (continued)

all other limits  $T_A = T_J = 25^\circ\text{C}$ . The grades C, D and E designate initial Reverse Breakdown Voltage tolerances of  $\pm 0.5\%$ ,  $\pm 1\%$  and  $\pm 2\%$ , respectively.

PARAMETER		TEST CONDITIONS		MIN <sup>(1)</sup>	TYP <sup>(2)</sup>	MAX <sup>(1)</sup>	UNIT
$Z_R$	Reverse Dynamic Impedance	$I_R = 1\text{ mA}$ , $f = 120\text{ Hz}$ , $I_{AC} = 0.1 I_R$	LM4040CEM3		0.3	0.9	$\Omega$
			LM4040DEM3		0.3	1.1	
			LM4040EEM3		0.3	1.1	
$e_N$	Wideband Noise	$I_R = 100\ \mu\text{A}$ $10\text{ Hz} \leq f \leq 10\text{ kHz}$			35		$\mu\text{V}_{\text{rms}}$
$\Delta V_R$	Reverse Breakdown Voltage Long Term Stability	$t = 1000\text{ hrs}$ $T = 25^\circ\text{C} \pm 0.1^\circ\text{C}$ $I_R = 100\ \mu\text{A}$			120		ppm
$V_{\text{HYST}}$	Thermal Hysteresis <sup>(5)</sup>	$\Delta T = -40^\circ\text{C}$ to $125^\circ\text{C}$			0.08%		

(5) Thermal hysteresis is defined as the difference in voltage measured at  $25^\circ\text{C}$  after cycling to temperature  $-40^\circ\text{C}$  and the  $25^\circ\text{C}$  measurement after cycling to temperature  $125^\circ\text{C}$ .

### 6.8 Electrical Characteristics: 2.5-V LM4040-N $V_R$ Tolerance Grades 'A' And 'B'; Temperature Grade 'I' (AEC Grade 3)

all other limits  $T_A = T_J = 25^\circ\text{C}$ . The grades A and B designate initial Reverse Breakdown Voltage tolerances of  $\pm 0.1\%$  and  $\pm 0.2\%$ , respectively.

PARAMETER		TEST CONDITIONS		MIN <sup>(1)</sup>	TYP <sup>(2)</sup>	MAX <sup>(1)</sup>	UNIT
$V_R$	Reverse Breakdown Voltage	$I_R = 100\ \mu\text{A}$			2.5		V
	Reverse Breakdown Voltage Tolerance <sup>(3)</sup>	$I_R = 100\ \mu\text{A}$	LM4040AIM3 LM4040AIZ LM4040AIM3	$T_A = T_J = 25^\circ\text{C}$		$\pm 2.5$	mV
				$T_A = T_J = T_{\text{MIN}}$ to $T_{\text{MAX}}$		$\pm 19$	
			LM4040BIM3 LM4040BIZ LM4040BIM7 LM4040QBIM3	$T_A = T_J = 25^\circ\text{C}$		$\pm 5$	
			$T_A = T_J = T_{\text{MIN}}$ to $T_{\text{MAX}}$		$\pm 21$		
$I_{\text{RMIN}}$	Minimum Operating Current		$T_A = T_J = 25^\circ\text{C}$		45	60	$\mu\text{A}$
			$T_A = T_J = T_{\text{MIN}}$ to $T_{\text{MAX}}$			65	
$\Delta V_R/\Delta T$	Average Reverse Breakdown Voltage Temperature Coefficient <sup>(3)</sup>	$I_R = 10\text{ mA}$			$\pm 20$		ppm/ $^\circ\text{C}$
		$I_R = 1\text{ mA}$	$T_A = T_J = 25^\circ\text{C}$		$\pm 15$		
			$T_A = T_J = T_{\text{MIN}}$ to $T_{\text{MAX}}$			$\pm 100$	
		$I_R = 100\ \mu\text{A}$			$\pm 15$		

(1) Limits are 100% production tested at  $25^\circ\text{C}$ . Limits over temperature are ensured through correlation using Statistical Quality Control (SQC) methods. The limits are used to calculate AOQL.

(2) Typicals are at  $T_J = 25^\circ\text{C}$  and represent most likely parametric norm.

(3) The overtemperature limit for Reverse Breakdown Voltage Tolerance is defined as the room temperature Reverse Breakdown Voltage Tolerance  $\pm[(\Delta V_R/\Delta T)(\text{max}\Delta T)(V_R)]$ . Where,  $\Delta V_R/\Delta T$  is the  $V_R$  temperature coefficient,  $\text{max}\Delta T$  is the maximum difference in temperature from the reference point of  $25^\circ\text{C}$  to  $T_{\text{MIN}}$  or  $T_{\text{MAX}}$ , and  $V_R$  is the reverse breakdown voltage. The total overtemperature tolerance for the different grades in the industrial temperature range where  $\text{max}\Delta T = 65^\circ\text{C}$  is shown below:

A-grade:  $\pm 0.75\% = \pm 0.1\% \pm 100\text{ ppm}/^\circ\text{C} \times 65^\circ\text{C}$

B-grade:  $\pm 0.85\% = \pm 0.2\% \pm 100\text{ ppm}/^\circ\text{C} \times 65^\circ\text{C}$

C-grade:  $\pm 1.15\% = \pm 0.5\% \pm 100\text{ ppm}/^\circ\text{C} \times 65^\circ\text{C}$

D-grade:  $\pm 1.98\% = \pm 1.0\% \pm 150\text{ ppm}/^\circ\text{C} \times 65^\circ\text{C}$

E-grade:  $\pm 2.98\% = \pm 2.0\% \pm 150\text{ ppm}/^\circ\text{C} \times 65^\circ\text{C}$

The total overtemperature tolerance for the different grades in the extended temperature range where  $\text{max}\Delta T = 100^\circ\text{C}$  is shown below:

C-grade:  $\pm 1.5\% = \pm 0.5\% \pm 100\text{ ppm}/^\circ\text{C} \times 100^\circ\text{C}$

D-grade:  $\pm 2.5\% = \pm 1.0\% \pm 150\text{ ppm}/^\circ\text{C} \times 100^\circ\text{C}$

E-grade:  $\pm 3.5\% = \pm 2.0\% \pm 150\text{ ppm}/^\circ\text{C} \times 100^\circ\text{C}$

Therefore, as an example, the A-grade 2.5-V LM4040-N has an overtemperature Reverse Breakdown Voltage tolerance of  $\pm 2.5\text{ V} \times 0.75\% = \pm 19\text{ mV}$ .

**Electrical Characteristics: 2.5-V LM4040-N  $V_R$  Tolerance Grades 'A' And 'B'; Temperature Grade 'I' (AEC Grade 3) (continued)**

all other limits  $T_A = T_J = 25^\circ\text{C}$ . The grades A and B designate initial Reverse Breakdown Voltage tolerances of  $\pm 0.1\%$  and  $\pm 0.2\%$ , respectively.

PARAMETER		TEST CONDITIONS		MIN <sup>(1)</sup>	TYP <sup>(2)</sup>	MAX <sup>(1)</sup>	UNIT
$\Delta V_{R/\Delta I_R}$	Reverse Breakdown Voltage Change with Operating Current Change <sup>(4)</sup>	$I_{R\text{MIN}} \leq I_R \leq 1 \text{ mA}$	$T_A = T_J = 25^\circ\text{C}$		0.3	0.8	mV
			$T_A = T_J = T_{\text{MIN}} \text{ to } T_{\text{MAX}}$			1	
		$1 \text{ mA} \leq I_R \leq 15 \text{ mA}$	$T_A = T_J = 25^\circ\text{C}$		2.5	6	
			$T_A = T_J = T_{\text{MIN}} \text{ to } T_{\text{MAX}}$			8	
$Z_R$	Reverse Dynamic Impedance	$I_R = 1 \text{ mA}$ , $f = 120 \text{ Hz}$ , $I_{AC} = 0.1 I_R$			0.3	0.8	$\Omega$
$e_N$	Wideband Noise	$I_R = 100 \mu\text{A}$ $10 \text{ Hz} \leq f \leq 10 \text{ kHz}$			35		$\mu\text{V}_{\text{rms}}$
$\Delta V_R$	Reverse Breakdown Voltage Long Term Stability	$t = 1000 \text{ hrs}$ $T = 25^\circ\text{C} \pm 0.1^\circ\text{C}$ $I_R = 100 \mu\text{A}$			120		ppm
$V_{\text{HYST}}$	Thermal Hysteresis <sup>(5)</sup>	$\Delta T = -40^\circ\text{C} \text{ to } 125^\circ\text{C}$			0.08%		

- (4) Load regulation is measured on pulse basis from no load to the specified load current. Output changes due to die temperature change must be taken into account separately.
- (5) Thermal hysteresis is defined as the difference in voltage measured at  $25^\circ\text{C}$  after cycling to temperature  $-40^\circ\text{C}$  and the  $25^\circ\text{C}$  measurement after cycling to temperature  $125^\circ\text{C}$ .

### 6.9 Electrical Characteristics: 2.5-V LM4040-N $V_R$ Tolerance Grades 'C', 'D', and 'E'; Temperature Grade 'I' (AEC Grade 3)

all other limits  $T_A = T_J = 25^\circ\text{C}$ . The grades C, D and E designate initial Reverse Breakdown Voltage tolerances of  $\pm 0.5\%$ ,  $\pm 1\%$  and  $\pm 2\%$ , respectively.

PARAMETER		TEST CONDITIONS		MIN <sup>(1)</sup>	TYP <sup>(2)</sup>	MAX <sup>(1)</sup>	UNIT		
$V_R$	Reverse Breakdown Voltage	$I_R = 100 \mu\text{A}$			2.5		V		
	Reverse Breakdown Voltage Tolerance <sup>(3)</sup>	$I_R = 100 \mu\text{A}$	LM4040CIZ LM4040CIM3	$T_A = T_J = 25^\circ\text{C}$		$\pm 12$	mV		
			LM4040CIM7 LM4040QCIM3	$T_A = T_J = T_{\text{MIN}}$ to $T_{\text{MAX}}$		$\pm 29$			
			LM4040DIZ LM4040DIM3	$T_A = T_J = 25^\circ\text{C}$		$\pm 25$			
			LM4040DIM7 LM4040QDIM3	$T_A = T_J = T_{\text{MIN}}$ to $T_{\text{MAX}}$		$\pm 49$			
			LM4040EIZ LM4040EIM3	$T_A = T_J = 25^\circ\text{C}$		$\pm 50$			
		LM4040EIM7 LM4040QEIM3	$T_A = T_J = T_{\text{MIN}}$ to $T_{\text{MAX}}$		$\pm 74$				
$I_{\text{RMIN}}$	Minimum Operating Current		LM4040CIZ LM4040CIM3	$T_A = T_J = 25^\circ\text{C}$	45	60	$\mu\text{A}$		
			LM4040CIM7 LM4040QCIM3	$T_A = T_J = T_{\text{MIN}}$ to $T_{\text{MAX}}$		65			
			LM4040DIZ LM4040DIM3	$T_A = T_J = 25^\circ\text{C}$	45	65			
			LM4040DIM7 LM4040QDIM3	$T_A = T_J = T_{\text{MIN}}$ to $T_{\text{MAX}}$		70			
			LM4040EIZ LM4040EIM3	$T_A = T_J = 25^\circ\text{C}$	45	65			
			LM4040EIM7 LM4040QEIM3	$T_A = T_J = T_{\text{MIN}}$ to $T_{\text{MAX}}$		70			
$\Delta V_R/\Delta T$	Average Reverse Breakdown Voltage Temperature Coefficient <sup>(3)</sup>	$I_R = 10 \text{ mA}$			$\pm 20$		ppm/ $^\circ\text{C}$		
					LM4040CIZ LM4040CIM3	$T_A = T_J = 25^\circ\text{C}$			$\pm 15$
					LM4040CIM7 LM4040QCIM3	$T_A = T_J = T_{\text{MIN}}$ to $T_{\text{MAX}}$			$\pm 100$
					LM4040DIZ LM4040DIM3	$T_A = T_J = 25^\circ\text{C}$			$\pm 15$
					LM4040DIM7 LM4040QDIM3	$T_A = T_J = T_{\text{MIN}}$ to $T_{\text{MAX}}$			$\pm 150$
					LM4040EIZ LM4040EIM3	$T_A = T_J = 25^\circ\text{C}$			$\pm 15$
		LM4040EIM7 LM4040QEIM3	$T_A = T_J = T_{\text{MIN}}$ to $T_{\text{MAX}}$		$\pm 150$				
		$I_R = 100 \mu\text{A}$			$\pm 15$				

- Limits are 100% production tested at  $25^\circ\text{C}$ . Limits over temperature are ensured through correlation using Statistical Quality Control (SQC) methods. The limits are used to calculate AOQL.
- Typicals are at  $T_J = 25^\circ\text{C}$  and represent most likely parametric norm.
- The overtemperature limit for Reverse Breakdown Voltage Tolerance is defined as the room temperature Reverse Breakdown Voltage Tolerance  $\pm[(\Delta V_R/\Delta T)(\text{max}\Delta T)(V_R)]$ . Where,  $\Delta V_R/\Delta T$  is the  $V_R$  temperature coefficient,  $\text{max}\Delta T$  is the maximum difference in temperature from the reference point of  $25^\circ\text{C}$  to  $T_{\text{MIN}}$  or  $T_{\text{MAX}}$ , and  $V_R$  is the reverse breakdown voltage. The total overtemperature tolerance for the different grades in the industrial temperature range where  $\text{max}\Delta T = 65^\circ\text{C}$  is shown below:  
A-grade:  $\pm 0.75\% = \pm 0.1\% \pm 100 \text{ ppm}/^\circ\text{C} \times 65^\circ\text{C}$   
B-grade:  $\pm 0.85\% = \pm 0.2\% \pm 100 \text{ ppm}/^\circ\text{C} \times 65^\circ\text{C}$   
C-grade:  $\pm 1.15\% = \pm 0.5\% \pm 100 \text{ ppm}/^\circ\text{C} \times 65^\circ\text{C}$   
D-grade:  $\pm 1.98\% = \pm 1.0\% \pm 150 \text{ ppm}/^\circ\text{C} \times 65^\circ\text{C}$   
E-grade:  $\pm 2.98\% = \pm 2.0\% \pm 150 \text{ ppm}/^\circ\text{C} \times 65^\circ\text{C}$   
The total overtemperature tolerance for the different grades in the extended temperature range where  $\text{max}\Delta T = 100^\circ\text{C}$  is shown below:  
C-grade:  $\pm 1.5\% = \pm 0.5\% \pm 100 \text{ ppm}/^\circ\text{C} \times 100^\circ\text{C}$   
D-grade:  $\pm 2.5\% = \pm 1.0\% \pm 150 \text{ ppm}/^\circ\text{C} \times 100^\circ\text{C}$   
E-grade:  $\pm 3.5\% = \pm 2.0\% \pm 150 \text{ ppm}/^\circ\text{C} \times 100^\circ\text{C}$   
Therefore, as an example, the A-grade 2.5-V LM4040-N has an overtemperature Reverse Breakdown Voltage tolerance of  $\pm 2.5V \times 0.75\% = \pm 19 \text{ mV}$ .

**Electrical Characteristics: 2.5-V LM4040-N  $V_R$  Tolerance Grades 'C', 'D', and 'E'; Temperature Grade 'I' (AEC Grade 3) (continued)**

all other limits  $T_A = T_J = 25^\circ\text{C}$ . The grades C, D and E designate initial Reverse Breakdown Voltage tolerances of  $\pm 0.5\%$ ,  $\pm 1\%$  and  $\pm 2\%$ , respectively.

PARAMETER	TEST CONDITIONS		MIN <sup>(1)</sup>	TYP <sup>(2)</sup>	MAX <sup>(1)</sup>	UNIT
$\Delta V_R / \Delta I_R$ Reverse Breakdown Voltage Change with Operating Current Change <sup>(4)</sup>	$I_{RMIN} \leq I_R \leq 1 \text{ mA}$	LM4040CIZ LM4040CIM3 LM4040CIM7 LM4040QCIM3	$T_A = T_J = 25^\circ\text{C}$	0.3	0.8	mV
			$T_A = T_J = T_{MIN} \text{ to } T_{MAX}$		1	
		LM4040DIZ LM4040DIM3 LM4040DIM7 LM4040QDIM3	$T_A = T_J = 25^\circ\text{C}$	0.3	1	
			$T_A = T_J = T_{MIN} \text{ to } T_{MAX}$		1.2	
		LM4040EIZ LM4040EIM3 LM4040EIM7 LM4040QEIM3	$T_A = T_J = 25^\circ\text{C}$	0.3	1	
			$T_A = T_J = T_{MIN} \text{ to } T_{MAX}$		1.2	
	$1 \text{ mA} \leq I_R \leq 15 \text{ mA}$	LM4040CIZ LM4040CIM3 LM4040CIM7 LM4040QCIM3	$T_A = T_J = 25^\circ\text{C}$	2.5	6	
			$T_A = T_J = T_{MIN} \text{ to } T_{MAX}$		8	
		LM4040DIZ LM4040DIM3 LM4040DIM7 LM4040QDIM3	$T_A = T_J = 25^\circ\text{C}$	2.5	8	
			$T_A = T_J = T_{MIN} \text{ to } T_{MAX}$		10	
		LM4040EIZ LM4040EIM3 LM4040EIM7 LM4040QEIM3	$T_A = T_J = 25^\circ\text{C}$	2.5	8	
			$T_A = T_J = T_{MIN} \text{ to } T_{MAX}$		10	
$Z_R$ Reverse Dynamic Impedance	$I_R = 1 \text{ mA}, f = 120 \text{ Hz}$ $I_{AC} = 0.1 I_R$	LM4040CIZ LM4040CIM3 LM4040CIM7 LM4040QCIM3		0.3	0.9	$\Omega$
		LM4040DIZ LM4040DIM3 LM4040DIM7 LM4040QDIM3		0.3	1.1	
		LM4040EIZ LM4040EIM3 LM4040EIM7 LM4040QEIM3		0.3	1.1	
$e_N$ Wideband Noise	$I_R = 100 \mu\text{A}$ $10 \text{ Hz} \leq f \leq 10 \text{ kHz}$			35		$\mu\text{V}_{rms}$
$\Delta V_R$ Reverse Breakdown Voltage Long Term Stability	$t = 1000 \text{ hrs}$ $T = 25^\circ\text{C} \pm 0.1^\circ\text{C}$ $I_R = 100 \mu\text{A}$			120		ppm
$V_{HYST}$ Thermal Hysteresis <sup>(5)</sup>	$\Delta T = -40^\circ\text{C} \text{ to } 125^\circ\text{C}$			0.08%		

(4) Load regulation is measured on pulse basis from no load to the specified load current. Output changes due to die temperature change must be taken into account separately.

(5) Thermal hysteresis is defined as the difference in voltage measured at  $25^\circ\text{C}$  after cycling to temperature  $-40^\circ\text{C}$  and the  $25^\circ\text{C}$  measurement after cycling to temperature  $125^\circ\text{C}$ .

## 6.10 Electrical Characteristics: 2.5-V LM4040-N $V_R$ Tolerance Grades 'C', 'D', And 'E'; Temperature Grade 'E' (AEC Grade 1)

all other limits  $T_A = T_J = 25^\circ\text{C}$ . The grades C, D and E designate initial Reverse Breakdown Voltage tolerances of  $\pm 0.5\%$ ,  $\pm 1\%$  and  $\pm 2\%$ , respectively.

PARAMETER		TEST CONDITIONS		MIN <sup>(1)</sup>	TYP <sup>(2)</sup>	MAX <sup>(1)</sup>	UNIT						
$V_R$	Reverse Breakdown Voltage	$I_R = 100 \mu\text{A}$			2.5		V						
	Reverse Breakdown Voltage Tolerance <sup>(3)</sup>	$I_R = 100 \mu\text{A}$	LM4040CEM3	$T_A = T_J = 25^\circ\text{C}$			$\pm 12$	mV					
			LM4040QCEM3	$T_A = T_J = T_{\text{MIN}}$ to $T_{\text{MAX}}$			$\pm 38$						
			LM4040DEM3	$T_A = T_J = 25^\circ\text{C}$			$\pm 25$						
			LM4040QDEM3	$T_A = T_J = T_{\text{MIN}}$ to $T_{\text{MAX}}$			$\pm 63$						
			LM4040EEM3	$T_A = T_J = 25^\circ\text{C}$			$\pm 50$						
LM4040QEEM3			$T_A = T_J = T_{\text{MIN}}$ to $T_{\text{MAX}}$			$\pm 88$							
$I_{\text{RMIN}}$	Minimum Operating Current		LM4040CEM3	$T_A = T_J = 25^\circ\text{C}$		45	60	$\mu\text{A}$					
			LM4040QCEM3	$T_A = T_J = T_{\text{MIN}}$ to $T_{\text{MAX}}$			68						
			LM4040DEM3	$T_A = T_J = 25^\circ\text{C}$		45	65						
			LM4040QDEM3	$T_A = T_J = T_{\text{MIN}}$ to $T_{\text{MAX}}$			73						
			LM4040EEM3	$T_A = T_J = 25^\circ\text{C}$		45	65						
			LM4040QEEM3	$T_A = T_J = T_{\text{MIN}}$ to $T_{\text{MAX}}$			73						
$\Delta V_R/\Delta T$	Average Reverse Breakdown Voltage Temperature Coefficient <sup>(3)</sup>	$I_R = 10 \text{ mA}$					ppm/ $^\circ\text{C}$						
								$I_R = 1 \text{ mA}$	LM4040CEM3	$T_A = T_J = 25^\circ\text{C}$		$\pm 20$	
									LM4040QCEM3	$T_A = T_J = T_{\text{MIN}}$ to $T_{\text{MAX}}$		$\pm 15$	$\pm 100$
									LM4040DEM3	$T_A = T_J = 25^\circ\text{C}$		$\pm 15$	
									LM4040QDEM3	$T_A = T_J = T_{\text{MIN}}$ to $T_{\text{MAX}}$			$\pm 150$
									LM4040EEM3	$T_A = T_J = 25^\circ\text{C}$		$\pm 15$	
LM4040QEEM3	$T_A = T_J = T_{\text{MIN}}$ to $T_{\text{MAX}}$			$\pm 150$									
$\Delta V_R/\Delta I_R$	Reverse Breakdown Voltage Change with Operating Current Change <sup>(4)</sup>	$I_{\text{RMIN}} \leq I_R \leq 1 \text{ mA}$					mV						
								LM4040CEM3	$T_A = T_J = 25^\circ\text{C}$	0.3	0.8		
								LM4040QCEM3	$T_A = T_J = T_{\text{MIN}}$ to $T_{\text{MAX}}$		1		
								LM4040DEM3	$T_A = T_J = 25^\circ\text{C}$	0.3	1		
								LM4040QDEM3	$T_A = T_J = T_{\text{MIN}}$ to $T_{\text{MAX}}$		1.2		
								LM4040EEM3	$T_A = T_J = 25^\circ\text{C}$	0.3	1		
		LM4040QEEM3	$T_A = T_J = T_{\text{MIN}}$ to $T_{\text{MAX}}$		1.2								
		$1 \text{ mA} \leq I_R \leq 15 \text{ mA}$							mV				
										LM4040CEM3	$T_A = T_J = 25^\circ\text{C}$	2.5	6
										LM4040QCEM3	$T_A = T_J = T_{\text{MIN}}$ to $T_{\text{MAX}}$		8
										LM4040DEM3	$T_A = T_J = 25^\circ\text{C}$	2.5	8
										LM4040QDEM3	$T_A = T_J = T_{\text{MIN}}$ to $T_{\text{MAX}}$		10
LM4040EEM3	$T_A = T_J = 25^\circ\text{C}$									2.5	8		
LM4040QEEM3	$T_A = T_J = T_{\text{MIN}}$ to $T_{\text{MAX}}$		10										

- Limits are 100% production tested at  $25^\circ\text{C}$ . Limits over temperature are ensured through correlation using Statistical Quality Control (SQC) methods. The limits are used to calculate AOQL.
- Typicals are at  $T_J = 25^\circ\text{C}$  and represent most likely parametric norm.
- The overtemperature limit for Reverse Breakdown Voltage Tolerance is defined as the room temperature Reverse Breakdown Voltage Tolerance  $\pm\{(\Delta V_R/\Delta T)(\text{max}\Delta T)(V_R)\}$ . Where,  $\Delta V_R/\Delta T$  is the  $V_R$  temperature coefficient,  $\text{max}\Delta T$  is the maximum difference in temperature from the reference point of  $25^\circ\text{C}$  to  $T_{\text{MIN}}$  or  $T_{\text{MAX}}$ , and  $V_R$  is the reverse breakdown voltage. The total overtemperature tolerance for the different grades in the industrial temperature range where  $\text{max}\Delta T = 65^\circ\text{C}$  is shown below:  
 A-grade:  $\pm 0.75\% = \pm 0.1\% \pm 100 \text{ ppm}/^\circ\text{C} \times 65^\circ\text{C}$   
 B-grade:  $\pm 0.85\% = \pm 0.2\% \pm 100 \text{ ppm}/^\circ\text{C} \times 65^\circ\text{C}$   
 C-grade:  $\pm 1.15\% = \pm 0.5\% \pm 100 \text{ ppm}/^\circ\text{C} \times 65^\circ\text{C}$   
 D-grade:  $\pm 1.98\% = \pm 1.0\% \pm 150 \text{ ppm}/^\circ\text{C} \times 65^\circ\text{C}$   
 E-grade:  $\pm 2.98\% = \pm 2.0\% \pm 150 \text{ ppm}/^\circ\text{C} \times 65^\circ\text{C}$   
 The total overtemperature tolerance for the different grades in the extended temperature range where  $\text{max}\Delta T = 100^\circ\text{C}$  is shown below:  
 C-grade:  $\pm 1.5\% = \pm 0.5\% \pm 100 \text{ ppm}/^\circ\text{C} \times 100^\circ\text{C}$   
 D-grade:  $\pm 2.5\% = \pm 1.0\% \pm 150 \text{ ppm}/^\circ\text{C} \times 100^\circ\text{C}$   
 E-grade:  $\pm 3.5\% = \pm 2.0\% \pm 150 \text{ ppm}/^\circ\text{C} \times 100^\circ\text{C}$   
 Therefore, as an example, the A-grade 2.5-V LM4040-N has an overtemperature Reverse Breakdown Voltage tolerance of  $\pm 2.5\text{V} \times 0.75\% = \pm 19 \text{ mV}$ .
- Load regulation is measured on pulse basis from no load to the specified load current. Output changes due to die temperature change must be taken into account separately.

**Electrical Characteristics: 2.5-V LM4040-N  $V_R$  Tolerance Grades 'C', 'D', And 'E'; Temperature Grade 'E' (AEC Grade 1) (continued)**

all other limits  $T_A = T_J = 25^\circ\text{C}$ . The grades C, D and E designate initial Reverse Breakdown Voltage tolerances of  $\pm 0.5\%$ ,  $\pm 1\%$  and  $\pm 2\%$ , respectively.

PARAMETER	TEST CONDITIONS		MIN <sup>(1)</sup>	TYP <sup>(2)</sup>	MAX <sup>(1)</sup>	UNIT
$Z_R$ Reverse Dynamic Impedance	$I_R = 1\text{ mA}$ , $f = 120\text{ Hz}$ , $I_{AC} = 0.1 I_R$	LM4040CEM3 LM4040QCEM3		0.3	0.9	$\Omega$
		LM4040DEM3 LM4040QDEM3		0.3	1.1	
		LM4040EEM3 LM4040QEEM3		0.3	1.1	
$e_N$ Wideband Noise	$I_R = 100\ \mu\text{A}$ $10\text{ Hz} \leq f \leq 10\text{ kHz}$			35		$\mu\text{V}_{\text{rms}}$
$\Delta V_R$ Reverse Breakdown Voltage Long Term Stability	$t = 1000\text{ hrs}$ $T = 25^\circ\text{C} \pm 0.1^\circ\text{C}$ $I_R = 100\ \mu\text{A}$			120		ppm
$V_{\text{HYST}}$ Thermal Hysteresis <sup>(5)</sup>	$\Delta T = -40^\circ\text{C}$ to $125^\circ\text{C}$			0.08%		

(5) Thermal hysteresis is defined as the difference in voltage measured at  $+25^\circ\text{C}$  after cycling to temperature  $-40^\circ\text{C}$  and the  $25^\circ\text{C}$  measurement after cycling to temperature  $125^\circ\text{C}$ .

## 6.11 Electrical Characteristics: 3-V LM4040-N $V_R$ Tolerance Grades 'A' And 'B'; Temperature Grade 'I'

all other limits  $T_A = T_J = 25^\circ\text{C}$ . The grades A and B designate initial Reverse Breakdown Voltage tolerances of  $\pm 0.1\%$  and  $\pm 0.2\%$ , respectively.

PARAMETER		TEST CONDITIONS		MIN <sup>(1)</sup>	TYP <sup>(2)</sup>	MAX <sup>(1)</sup>	UNIT
$V_R$	Reverse Breakdown Voltage	$I_R = 100\ \mu\text{A}$			3		V
	Reverse Breakdown Voltage Tolerance <sup>(3)</sup>	$I_R = 100\ \mu\text{A}$	LM4040AIM3 LM4040AIZ	$T_A = T_J = 25^\circ\text{C}$		$\pm 3$	mV
				$T_A = T_J = T_{\text{MIN}}$ to $T_{\text{MAX}}$		$\pm 22$	
			LM4040BIM3 LM4040BIZ LM4040BIM7	$T_A = T_J = 25^\circ\text{C}$		$\pm 6$	
			$T_A = T_J = T_{\text{MIN}}$ to $T_{\text{MAX}}$		$\pm 26$		
$I_{\text{RMIN}}$	Minimum Operating Current		$T_A = T_J = 25^\circ\text{C}$		47	62	$\mu\text{A}$
			$T_A = T_J = T_{\text{MIN}}$ to $T_{\text{MAX}}$			67	
$\Delta V_R/\Delta T$	Average Reverse Breakdown Voltage Temperature Coefficient <sup>(3)</sup>	$I_R = 10\ \text{mA}$			$\pm 20$		ppm/ $^\circ\text{C}$
		$I_R = 1\ \text{mA}$	$T_A = T_J = 25^\circ\text{C}$		$\pm 15$		
			$T_A = T_J = T_{\text{MIN}}$ to $T_{\text{MAX}}$			$\pm 100$	
$I_R = 100\ \mu\text{A}$				$\pm 15$			
$\Delta V_R/\Delta I_R$	Reverse Breakdown Voltage Change with Operating Current Change <sup>(4)</sup>	$I_{\text{RMIN}} \leq I_R \leq 1\ \text{mA}$	$T_A = T_J = 25^\circ\text{C}$		0.6	0.8	mV
			$T_A = T_J = T_{\text{MIN}}$ to $T_{\text{MAX}}$			1.1	
		$1\ \text{mA} \leq I_R \leq 15\ \text{mA}$	$T_A = T_J = 25^\circ\text{C}$		2.7	6	
			$T_A = T_J = T_{\text{MIN}}$ to $T_{\text{MAX}}$			9	
$Z_R$	Reverse Dynamic Impedance	$I_R = 1\ \text{mA}$ , $f = 120\ \text{Hz}$ , $I_{\text{AC}} = 0.1\ I_R$			0.4	0.9	$\Omega$
$e_N$	Wideband Noise	$I_R = 100\ \mu\text{A}$ $10\ \text{Hz} \leq f \leq 10\ \text{kHz}$			35		$\mu\text{V}_{\text{rms}}$
$\Delta V_R$	Reverse Breakdown Voltage Long Term Stability	$t = 1000\ \text{hrs}$ $T = 25^\circ\text{C} \pm 0.1^\circ\text{C}$ $I_R = 100\ \mu\text{A}$			120		ppm
$V_{\text{HYST}}$	Thermal Hysteresis <sup>(5)</sup>	$\Delta T = -40^\circ\text{C}$ to $125^\circ\text{C}$			0.08%		

- Limits are 100% production tested at  $25^\circ\text{C}$ . Limits over temperature are ensured through correlation using Statistical Quality Control (SQC) methods. The limits are used to calculate AOQL.
- Typicals are at  $T_J = 25^\circ\text{C}$  and represent most likely parametric norm.
- The overtemperature limit for Reverse Breakdown Voltage Tolerance is defined as the room temperature Reverse Breakdown Voltage Tolerance  $\pm[(\Delta V_R/\Delta T)(\text{max}\Delta T)(V_R)]$ . Where,  $\Delta V_R/\Delta T$  is the  $V_R$  temperature coefficient,  $\text{max}\Delta T$  is the maximum difference in temperature from the reference point of  $25^\circ\text{C}$  to  $T_{\text{MIN}}$  or  $T_{\text{MAX}}$ , and  $V_R$  is the reverse breakdown voltage. The total overtemperature tolerance for the different grades in the industrial temperature range where  $\text{max}\Delta T = 65^\circ\text{C}$  is shown below:  
A-grade:  $\pm 0.75\% = \pm 0.1\% \pm 100\ \text{ppm}/^\circ\text{C} \times 65^\circ\text{C}$   
B-grade:  $\pm 0.85\% = \pm 0.2\% \pm 100\ \text{ppm}/^\circ\text{C} \times 65^\circ\text{C}$   
C-grade:  $\pm 1.15\% = \pm 0.5\% \pm 100\ \text{ppm}/^\circ\text{C} \times 65^\circ\text{C}$   
D-grade:  $\pm 1.98\% = \pm 1.0\% \pm 150\ \text{ppm}/^\circ\text{C} \times 65^\circ\text{C}$   
E-grade:  $\pm 2.98\% = \pm 2.0\% \pm 150\ \text{ppm}/^\circ\text{C} \times 65^\circ\text{C}$   
The total overtemperature tolerance for the different grades in the extended temperature range where  $\text{max}\Delta T = 100^\circ\text{C}$  is shown below:  
C-grade:  $\pm 1.5\% = \pm 0.5\% \pm 100\ \text{ppm}/^\circ\text{C} \times 100^\circ\text{C}$   
D-grade:  $\pm 2.5\% = \pm 1.0\% \pm 150\ \text{ppm}/^\circ\text{C} \times 100^\circ\text{C}$   
E-grade:  $\pm 3.5\% = \pm 2.0\% \pm 150\ \text{ppm}/^\circ\text{C} \times 100^\circ\text{C}$   
Therefore, as an example, the A-grade 2.5-V LM4040-N has an overtemperature Reverse Breakdown Voltage tolerance of  $\pm 2.5\text{V} \times 0.75\% = \pm 19\ \text{mV}$ .
- Load regulation is measured on pulse basis from no load to the specified load current. Output changes due to die temperature change must be taken into account separately.
- Thermal hysteresis is defined as the difference in voltage measured at  $+25^\circ\text{C}$  after cycling to temperature  $-40^\circ\text{C}$  and the  $25^\circ\text{C}$  measurement after cycling to temperature  $125^\circ\text{C}$ .

## 6.12 Electrical Characteristics: 3-V LM4040-N $V_R$ Tolerance Grades 'C', 'D', And 'E'; Temperature Grade 'I'

all other limits  $T_A = T_J = 25^\circ\text{C}$ . The grades C, D and E designate initial Reverse Breakdown Voltage tolerances of  $\pm 0.5\%$ ,  $\pm 1\%$  and  $\pm 2\%$ , respectively.

PARAMETER		TEST CONDITIONS		MIN <sup>(1)</sup>	TYP <sup>(2)</sup>	MAX <sup>(1)</sup>	UNIT	
$V_R$	Reverse Breakdown Voltage	$I_R = 100 \mu\text{A}$			3		V	
	Reverse Breakdown Voltage Tolerance <sup>(3)</sup>	$I_R = 100 \mu\text{A}$	LM4040CIM3	$T_A = T_J = 25^\circ\text{C}$		$\pm 15$	mV	
			LM4040CIZ	$T_A = T_J = T_{\text{MIN}}$ to $T_{\text{MAX}}$		$\pm 34$		
			LM4040DIM3	$T_A = T_J = 25^\circ\text{C}$		$\pm 30$		
			LM4040DIZ	$T_A = T_J = T_{\text{MIN}}$ to $T_{\text{MAX}}$		$\pm 59$		
			LM4040DIM7	$T_A = T_J = T_{\text{MIN}}$ to $T_{\text{MAX}}$		$\pm 59$		
$I_{\text{RMIN}}$	Minimum Operating Current		LM4040CIM3	$T_A = T_J = 25^\circ\text{C}$		45	60	$\mu\text{A}$
			LM4040CIZ	$T_A = T_J = T_{\text{MIN}}$ to $T_{\text{MAX}}$			65	
			LM4040CIM7	$T_A = T_J = T_{\text{MIN}}$ to $T_{\text{MAX}}$			65	
			LM4040DIM3	$T_A = T_J = 25^\circ\text{C}$		45	65	
			LM4040DIZ	$T_A = T_J = T_{\text{MIN}}$ to $T_{\text{MAX}}$			70	
			LM4040DIM7	$T_A = T_J = T_{\text{MIN}}$ to $T_{\text{MAX}}$			70	
$\Delta V_R/\Delta T$	Average Reverse Breakdown Voltage Temperature Coefficient <sup>(3)</sup>	$I_R = 10 \text{ mA}$				$\pm 20$	ppm/ $^\circ\text{C}$	
		$I_R = 1 \text{ mA}$	LM4040CIM3	$T_A = T_J = 25^\circ\text{C}$		$\pm 15$		
			LM4040CIZ	$T_A = T_J = T_{\text{MIN}}$ to $T_{\text{MAX}}$		$\pm 100$		
			LM4040CIM7	$T_A = T_J = T_{\text{MIN}}$ to $T_{\text{MAX}}$		$\pm 100$		
			LM4040DIM3	$T_A = T_J = 25^\circ\text{C}$		$\pm 15$		
			LM4040DIZ	$T_A = T_J = T_{\text{MIN}}$ to $T_{\text{MAX}}$		$\pm 150$		
			LM4040DIM7	$T_A = T_J = T_{\text{MIN}}$ to $T_{\text{MAX}}$		$\pm 150$		
		$I_R = 100 \mu\text{A}$	LM4040EIM7	$T_A = T_J = 25^\circ\text{C}$		$\pm 15$		
LM4040EIZ	$T_A = T_J = T_{\text{MIN}}$ to $T_{\text{MAX}}$			$\pm 150$				

- (1) Limits are 100% production tested at  $25^\circ\text{C}$ . Limits over temperature are ensured through correlation using Statistical Quality Control (SQC) methods. The limits are used to calculate AOQL.
- (2) Typicals are at  $T_J = 25^\circ\text{C}$  and represent most likely parametric norm.
- (3) The overtemperature limit for Reverse Breakdown Voltage Tolerance is defined as the room temperature Reverse Breakdown Voltage Tolerance  $\pm[(\Delta V_R/\Delta T)(\text{max}\Delta T)(V_R)]$ . Where,  $\Delta V_R/\Delta T$  is the  $V_R$  temperature coefficient,  $\text{max}\Delta T$  is the maximum difference in temperature from the reference point of  $25^\circ\text{C}$  to  $T_{\text{MIN}}$  or  $T_{\text{MAX}}$ , and  $V_R$  is the reverse breakdown voltage. The total overtemperature tolerance for the different grades in the industrial temperature range where  $\text{max}\Delta T = 65^\circ\text{C}$  is shown below:  
 A-grade:  $\pm 0.75\% = \pm 0.1\% \pm 100 \text{ ppm}/^\circ\text{C} \times 65^\circ\text{C}$   
 B-grade:  $\pm 0.85\% = \pm 0.2\% \pm 100 \text{ ppm}/^\circ\text{C} \times 65^\circ\text{C}$   
 C-grade:  $\pm 1.15\% = \pm 0.5\% \pm 100 \text{ ppm}/^\circ\text{C} \times 65^\circ\text{C}$   
 D-grade:  $\pm 1.98\% = \pm 1.0\% \pm 150 \text{ ppm}/^\circ\text{C} \times 65^\circ\text{C}$   
 E-grade:  $\pm 2.98\% = \pm 2.0\% \pm 150 \text{ ppm}/^\circ\text{C} \times 65^\circ\text{C}$   
 The total overtemperature tolerance for the different grades in the extended temperature range where  $\text{max}\Delta T = 100^\circ\text{C}$  is shown below:  
 C-grade:  $\pm 1.5\% = \pm 0.5\% \pm 100 \text{ ppm}/^\circ\text{C} \times 100^\circ\text{C}$   
 D-grade:  $\pm 2.5\% = \pm 1.0\% \pm 150 \text{ ppm}/^\circ\text{C} \times 100^\circ\text{C}$   
 E-grade:  $\pm 3.5\% = \pm 2.0\% \pm 150 \text{ ppm}/^\circ\text{C} \times 100^\circ\text{C}$   
 Therefore, as an example, the A-grade 2.5-V LM4040-N has an overtemperature Reverse Breakdown Voltage tolerance of  $\pm 2.5V \times 0.75\% = \pm 19 \text{ mV}$ .

**Electrical Characteristics: 3-V LM4040-N  $V_R$  Tolerance Grades 'C', 'D', And 'E'; Temperature Grade 'I' (continued)**

all other limits  $T_A = T_J = 25^\circ\text{C}$ . The grades C, D and E designate initial Reverse Breakdown Voltage tolerances of  $\pm 0.5\%$ ,  $\pm 1\%$  and  $\pm 2\%$ , respectively.

PARAMETER	TEST CONDITIONS		MIN <sup>(1)</sup>	TYP <sup>(2)</sup>	MAX <sup>(1)</sup>	UNIT
$\Delta V_{R}/\Delta I_R$ Reverse Breakdown Voltage Change with Operating Current Change <sup>(4)</sup>	$I_{R\text{MIN}} \leq I_R \leq 1 \text{ mA}$	LM4040CIM3 LM4040CIZ LM4040CIM7	$T_A = T_J = 25^\circ\text{C}$	0.4	0.8	mV
			$T_A = T_J = T_{\text{MIN}} \text{ to } T_{\text{MAX}}$		1.1	
		LM4040DIM3 LM4040DIZ LM4040DIM7	$T_A = T_J = 25^\circ\text{C}$	0.4	1.1	
			$T_A = T_J = T_{\text{MIN}} \text{ to } T_{\text{MAX}}$		1.3	
		LM4040EIM7 LM4040EIZ	$T_A = T_J = 25^\circ\text{C}$	0.4	1.1	
			$T_A = T_J = T_{\text{MIN}} \text{ to } T_{\text{MAX}}$		1.3	
	$1 \text{ mA} \leq I_R \leq 15 \text{ mA}$	LM4040CIM3 LM4040CIZ LM4040CIM7	$T_A = T_J = 25^\circ\text{C}$	2.7	6	
			$T_A = T_J = T_{\text{MIN}} \text{ to } T_{\text{MAX}}$		9	
		LM4040DIM3 LM4040DIZ LM4040DIM7	$T_A = T_J = 25^\circ\text{C}$	2.7	8	
			$T_A = T_J = T_{\text{MIN}} \text{ to } T_{\text{MAX}}$		11	
		LM4040EIM7 LM4040EIZ	$T_A = T_J = 25^\circ\text{C}$	2.7	8	
			$T_A = T_J = T_{\text{MIN}} \text{ to } T_{\text{MAX}}$		11	
$Z_R$ Reverse Dynamic Impedance	$I_R = 1 \text{ mA}, f = 120 \text{ Hz}$ $I_{AC} = 0.1 I_R$	LM4040CIM3 LM4040CIZ LM4040CIM7		0.4	0.9	$\Omega$
		LM4040DIM3 LM4040DIZ LM4040DIM7		0.4	1.2	
		LM4040EIM7 LM4040EIZ		0.4	1.2	
$e_N$ Wideband Noise	$I_R = 100 \mu\text{A}$ $10 \text{ Hz} \leq f \leq 10 \text{ kHz}$			35		$\mu\text{V}_{\text{rms}}$
$\Delta V_R$ Reverse Breakdown Voltage Long Term Stability	$t = 1000 \text{ hrs}$ $T = 25^\circ\text{C} \pm 0.1^\circ\text{C}$ $I_R = 100 \mu\text{A}$			120		ppm
$V_{\text{HYST}}$ Thermal Hysteresis <sup>(5)</sup>	$\Delta T = -40^\circ\text{C} \text{ to } 125^\circ\text{C}$			0.08%		

(4) Load regulation is measured on pulse basis from no load to the specified load current. Output changes due to die temperature change must be taken into account separately.

(5) Thermal hysteresis is defined as the difference in voltage measured at  $+25^\circ\text{C}$  after cycling to temperature  $-40^\circ\text{C}$  and the  $25^\circ\text{C}$  measurement after cycling to temperature  $125^\circ\text{C}$ .

### 6.13 Electrical Characteristics: 3-V LM4040-N $V_R$ Tolerance Grades 'C', 'D', And 'E'; Temperature Grade 'E'

all other limits  $T_A = T_J = 25^\circ\text{C}$ . The grades C, D and E designate initial Reverse Breakdown Voltage tolerances of  $\pm 0.5\%$ ,  $\pm 1\%$  and  $\pm 2\%$ , respectively.

PARAMETER		TEST CONDITIONS		MIN <sup>(1)</sup>	TYP <sup>(2)</sup>	MAX <sup>(1)</sup>	UNIT
$V_R$	Reverse Breakdown Voltage	$I_R = 100 \mu\text{A}$			3		V
	Reverse Breakdown Voltage Tolerance <sup>(3)</sup>	$I_R = 100 \mu\text{A}$	LM4040CEM3	$T_A = T_J = 25^\circ\text{C}$		$\pm 15$	mV
				$T_A = T_J = T_{\text{MIN}}$ to $T_{\text{MAX}}$		$\pm 45$	
			LM4040DEM3	$T_A = T_J = 25^\circ\text{C}$		$\pm 30$	
				$T_A = T_J = T_{\text{MIN}}$ to $T_{\text{MAX}}$		$\pm 75$	
			LM4040EEM3	$T_A = T_J = 25^\circ\text{C}$		$\pm 60$	
$T_A = T_J = T_{\text{MIN}}$ to $T_{\text{MAX}}$					$\pm 105$		
$I_{\text{RMIN}}$	Minimum Operating Current		LM4040CEM3	$T_A = T_J = 25^\circ\text{C}$	47	62	$\mu\text{A}$
				$T_A = T_J = T_{\text{MIN}}$ to $T_{\text{MAX}}$		70	
			LM4040DEM3	$T_A = T_J = 25^\circ\text{C}$	47	67	
				$T_A = T_J = T_{\text{MIN}}$ to $T_{\text{MAX}}$		75	
			LM4040EEM3	$T_A = T_J = 25^\circ\text{C}$	47	67	
				$T_A = T_J = T_{\text{MIN}}$ to $T_{\text{MAX}}$		75	
$\Delta V_R/\Delta T$	Average Reverse Breakdown Voltage Temperature Coefficient <sup>(3)</sup>	$I_R = 10 \text{ mA}$	LM4040CEM3	$T_A = T_J = 25^\circ\text{C}$		$\pm 20$	ppm/ $^\circ\text{C}$
				$T_A = T_J = T_{\text{MIN}}$ to $T_{\text{MAX}}$		$\pm 15$	
		$I_R = 1 \text{ mA}$	LM4040DEM3	$T_A = T_J = 25^\circ\text{C}$		$\pm 15$	
				$T_A = T_J = T_{\text{MIN}}$ to $T_{\text{MAX}}$		$\pm 150$	
		LM4040EEM3	$T_A = T_J = 25^\circ\text{C}$		$\pm 15$		
			$T_A = T_J = T_{\text{MIN}}$ to $T_{\text{MAX}}$		$\pm 150$		
		$I_R = 100 \mu\text{A}$			$\pm 15$		
		$\Delta V_R/\Delta I_R$	Reverse Breakdown Voltage Change with Operating Current Change <sup>(4)</sup>	$I_{\text{RMIN}} \leq I_R \leq 1 \text{ mA}$	LM4040CEM3	$T_A = T_J = 25^\circ\text{C}$	
$T_A = T_J = T_{\text{MIN}}$ to $T_{\text{MAX}}$						1.1	
LM4040DEM3	$T_A = T_J = 25^\circ\text{C}$				0.4	1.1	
	$T_A = T_J = T_{\text{MIN}}$ to $T_{\text{MAX}}$					1.3	
LM4040EEM3	$T_A = T_J = 25^\circ\text{C}$				0.4	1.1	
	$T_A = T_J = T_{\text{MIN}}$ to $T_{\text{MAX}}$					1.3	
$1 \text{ mA} \leq I_R \leq 15 \text{ mA}$	LM4040CEM3			$T_A = T_J = 25^\circ\text{C}$	2.7	6.0	
				$T_A = T_J = T_{\text{MIN}}$ to $T_{\text{MAX}}$		9	
	LM4040DEM3			$T_A = T_J = 25^\circ\text{C}$	2.7	8	
				$T_A = T_J = T_{\text{MIN}}$ to $T_{\text{MAX}}$		11.0	
	LM4040EEM3			$T_A = T_J = 25^\circ\text{C}$	2.7	8	
				$T_A = T_J = T_{\text{MIN}}$ to $T_{\text{MAX}}$		11.0	

- Limits are 100% production tested at  $25^\circ\text{C}$ . Limits over temperature are ensured through correlation using Statistical Quality Control (SQC) methods. The limits are used to calculate AOQL.
- Typicals are at  $T_J = 25^\circ\text{C}$  and represent most likely parametric norm.
- The (overtemperature) limit for Reverse Breakdown Voltage Tolerance is defined as the room temperature Reverse Breakdown Voltage Tolerance  $\pm[(\Delta V_R/\Delta T)(\text{max}\Delta T)(V_R)]$ . Where,  $\Delta V_R/\Delta T$  is the  $V_R$  temperature coefficient,  $\text{max}\Delta T$  is the maximum difference in temperature from the reference point of  $25^\circ\text{C}$  to  $T_{\text{MIN}}$  or  $T_{\text{MAX}}$ , and  $V_R$  is the reverse breakdown voltage. The total overtemperature tolerance for the different grades in the industrial temperature range where  $\text{max}\Delta T = 65^\circ\text{C}$  is shown below:  
 A-grade:  $\pm 0.75\% = \pm 0.1\% \pm 100 \text{ ppm}/^\circ\text{C} \times 65^\circ\text{C}$   
 B-grade:  $\pm 0.85\% = \pm 0.2\% \pm 100 \text{ ppm}/^\circ\text{C} \times 65^\circ\text{C}$   
 C-grade:  $\pm 1.15\% = \pm 0.5\% \pm 100 \text{ ppm}/^\circ\text{C} \times 65^\circ\text{C}$   
 D-grade:  $\pm 1.98\% = \pm 1.0\% \pm 150 \text{ ppm}/^\circ\text{C} \times 65^\circ\text{C}$   
 E-grade:  $\pm 2.98\% = \pm 2.0\% \pm 150 \text{ ppm}/^\circ\text{C} \times 65^\circ\text{C}$   
 The total overtemperature tolerance for the different grades in the extended temperature range where  $\text{max}\Delta T = 100^\circ\text{C}$  is shown below:  
 C-grade:  $\pm 1.5\% = \pm 0.5\% \pm 100 \text{ ppm}/^\circ\text{C} \times 100^\circ\text{C}$   
 D-grade:  $\pm 2.5\% = \pm 1.0\% \pm 150 \text{ ppm}/^\circ\text{C} \times 100^\circ\text{C}$   
 E-grade:  $\pm 3.5\% = \pm 2.0\% \pm 150 \text{ ppm}/^\circ\text{C} \times 100^\circ\text{C}$   
 Therefore, as an example, the A-grade 2.5-V LM4040-N has an overtemperature Reverse Breakdown Voltage tolerance of  $\pm 2.5\text{V} \times 0.75\% = \pm 19 \text{ mV}$ .
- Load regulation is measured on pulse basis from no load to the specified load current. Output changes due to die temperature change must be taken into account separately.

### Electrical Characteristics: 3-V LM4040-N $V_R$ Tolerance Grades 'C', 'D', And 'E'; Temperature Grade 'E' (continued)

all other limits  $T_A = T_J = 25^\circ\text{C}$ . The grades C, D and E designate initial Reverse Breakdown Voltage tolerances of  $\pm 0.5\%$ ,  $\pm 1\%$  and  $\pm 2\%$ , respectively.

PARAMETER		TEST CONDITIONS		MIN <sup>(1)</sup>	TYP <sup>(2)</sup>	MAX <sup>(1)</sup>	UNIT
$Z_R$	Reverse Dynamic Impedance	$I_R = 1\text{ mA}$ , $f = 120\text{ Hz}$ , $I_{AC} = 0.1 I_R$	LM4040CEM3		0.4	0.9	$\Omega$
			LM4040DEM3		0.4	1.2	
			LM4040EEM3		0.4	1.2	
$e_N$	Wideband Noise	$I_R = 100\ \mu\text{A}$ $10\text{ Hz} \leq f \leq 10\text{ kHz}$			35		$\mu\text{V}_{\text{rms}}$
$\Delta V_R$	Reverse Breakdown Voltage Long Term Stability	$t = 1000\text{ hrs}$ $T = 25^\circ\text{C} \pm 0.1^\circ\text{C}$ $I_R = 100\ \mu\text{A}$			120		ppm
$V_{\text{HYST}}$	Thermal Hysteresis <sup>(5)</sup>	$\Delta T = -40^\circ\text{C}$ to $125^\circ\text{C}$			0.08%		

(5) Thermal hysteresis is defined as the difference in voltage measured at  $+25^\circ\text{C}$  after cycling to temperature  $-40^\circ\text{C}$  and the  $25^\circ\text{C}$  measurement after cycling to temperature  $125^\circ\text{C}$ .

### 6.14 Electrical Characteristics: 4.1-V LM4040-N $V_R$ Tolerance Grades 'A' And 'B'; Temperature Grade 'I'

all other limits  $T_A = T_J = 25^\circ\text{C}$ . The grades A and B designate initial Reverse Breakdown Voltage tolerances of  $\pm 0.1\%$  and  $\pm 0.2\%$ , respectively.

PARAMETER		TEST CONDITIONS		MIN <sup>(1)</sup>	TYP <sup>(2)</sup>	MAX <sup>(1)</sup>	UNIT
$V_R$	Reverse Breakdown Voltage	$I_R = 100\ \mu\text{A}$			4.096		V
	Reverse Breakdown Voltage Tolerance <sup>(3)</sup>	$I_R = 100\ \mu\text{A}$	LM4040AIM3 LM4040AIZ	$T_A = T_J = 25^\circ\text{C}$		$\pm 4.1$	mV
				$T_A = T_J = T_{\text{MIN}}$ to $T_{\text{MAX}}$		$\pm 31$	
			LM4040BIM3 LM4040BIZ LM4040BIM7	$T_A = T_J = 25^\circ\text{C}$		$\pm 8.2$	
			$T_A = T_J = T_{\text{MIN}}$ to $T_{\text{MAX}}$		$\pm 35$		
$I_{\text{RMIN}}$	Minimum Operating Current		$T_A = T_J = 25^\circ\text{C}$		50	68	$\mu\text{A}$
			$T_A = T_J = T_{\text{MIN}}$ to $T_{\text{MAX}}$			73	
$\Delta V_R/\Delta T$	Average Reverse Breakdown Voltage Temperature Coefficient <sup>(3)</sup>	$I_R = 10\text{ mA}$			$\pm 30$		ppm/ $^\circ\text{C}$
		$I_R = 1\text{ mA}$	$T_A = T_J = 25^\circ\text{C}$		$\pm 20$		
			$T_A = T_J = T_{\text{MIN}}$ to $T_{\text{MAX}}$			$\pm 100$	
$I_R = 100\ \mu\text{A}$				$\pm 20$			
$\Delta V_R/\Delta I_R$	Reverse Breakdown Voltage Change with Operating Current Change <sup>(4)</sup>	$I_{\text{RMIN}} \leq I_R \leq 1\text{ mA}$	$T_A = T_J = 25^\circ\text{C}$		0.5	0.9	mV
			$T_A = T_J = T_{\text{MIN}}$ to $T_{\text{MAX}}$			1.2	
		$1\text{ mA} \leq I_R \leq 15\text{ mA}$	$T_A = T_J = 25^\circ\text{C}$		3	7	
			$T_A = T_J = T_{\text{MIN}}$ to $T_{\text{MAX}}$			10	

(1) Limits are 100% production tested at  $25^\circ\text{C}$ . Limits over temperature are ensured through correlation using Statistical Quality Control (SQC) methods. The limits are used to calculate AOQL.

(2) Typicals are at  $T_J = 25^\circ\text{C}$  and represent most likely parametric norm.

(3) The (overtemperature) limit for Reverse Breakdown Voltage Tolerance is defined as the room temperature Reverse Breakdown Voltage Tolerance  $\pm[(\Delta V_R/\Delta T)(\text{max}\Delta T)(V_R)]$ . Where,  $\Delta V_R/\Delta T$  is the  $V_R$  temperature coefficient,  $\text{max}\Delta T$  is the maximum difference in temperature from the reference point of  $25^\circ\text{C}$  to  $T_{\text{MIN}}$  or  $T_{\text{MAX}}$ , and  $V_R$  is the reverse breakdown voltage. The total overtemperature tolerance for the different grades in the industrial temperature range where  $\text{max}\Delta T = 65^\circ\text{C}$  is shown below:

A-grade:  $\pm 0.75\% = \pm 0.1\% \pm 100\text{ ppm}/^\circ\text{C} \times 65^\circ\text{C}$

B-grade:  $\pm 0.85\% = \pm 0.2\% \pm 100\text{ ppm}/^\circ\text{C} \times 65^\circ\text{C}$

C-grade:  $\pm 1.15\% = \pm 0.5\% \pm 100\text{ ppm}/^\circ\text{C} \times 65^\circ\text{C}$

D-grade:  $\pm 1.98\% = \pm 1.0\% \pm 150\text{ ppm}/^\circ\text{C} \times 65^\circ\text{C}$

E-grade:  $\pm 2.98\% = \pm 2.0\% \pm 150\text{ ppm}/^\circ\text{C} \times 65^\circ\text{C}$

The total overtemperature tolerance for the different grades in the extended temperature range where  $\text{max}\Delta T = 100^\circ\text{C}$  is shown below:

C-grade:  $\pm 1.5\% = \pm 0.5\% \pm 100\text{ ppm}/^\circ\text{C} \times 100^\circ\text{C}$

D-grade:  $\pm 2.5\% = \pm 1.0\% \pm 150\text{ ppm}/^\circ\text{C} \times 100^\circ\text{C}$

E-grade:  $\pm 3.5\% = \pm 2.0\% \pm 150\text{ ppm}/^\circ\text{C} \times 100^\circ\text{C}$

Therefore, as an example, the A-grade 2.5-V LM4040-N has an overtemperature Reverse Breakdown Voltage tolerance of  $\pm 2.5\text{ V} \times 0.75\% = \pm 19\text{ mV}$ .

(4) Load regulation is measured on pulse basis from no load to the specified load current. Output changes due to die temperature change must be taken into account separately.

### Electrical Characteristics: 4.1-V LM4040-N $V_R$ Tolerance Grades 'A' And 'B'; Temperature Grade 'I' (continued)

all other limits  $T_A = T_J = 25^\circ\text{C}$ . The grades A and B designate initial Reverse Breakdown Voltage tolerances of  $\pm 0.1\%$  and  $\pm 0.2\%$ , respectively.

PARAMETER		TEST CONDITIONS		MIN <sup>(1)</sup>	TYP <sup>(2)</sup>	MAX <sup>(1)</sup>	UNIT
$Z_R$	Reverse Dynamic Impedance	$I_R = 1\text{ mA}$ , $f = 120\text{ Hz}$ , $I_{AC} = 0.1 I_R$			0.5	1	$\Omega$
$e_N$	Wideband Noise	$I_R = 100\ \mu\text{A}$ $10\text{ Hz} \leq f \leq 10\text{ kHz}$			80		$\mu\text{V}_{\text{rms}}$
$\Delta V_R$	Reverse Breakdown Voltage Long Term Stability	$t = 1000\text{ hrs}$ $T = 25^\circ\text{C} \pm 0.1^\circ\text{C}$ $I_R = 100\ \mu\text{A}$			120		ppm
$V_{\text{HYST}}$	Thermal Hysteresis <sup>(5)</sup>	$\Delta T = -40^\circ\text{C}$ to $125^\circ\text{C}$			0.08%		

(5) Thermal hysteresis is defined as the difference in voltage measured at  $+25^\circ\text{C}$  after cycling to temperature  $-40^\circ\text{C}$  and the  $25^\circ\text{C}$  measurement after cycling to temperature  $125^\circ\text{C}$ .

### 6.15 Electrical Characteristics: 4.1-V LM4040-N $V_R$ Tolerance Grades 'C' and 'D'; Temperature Grade 'I'

all other limits  $T_A = T_J = 25^\circ\text{C}$ . The grades C and D designate initial Reverse Breakdown Voltage tolerances of  $\pm 0.5\%$  and  $\pm 1\%$ , respectively.

PARAMETER		TEST CONDITIONS		MIN <sup>(1)</sup>	TYP <sup>(2)</sup>	MAX <sup>(1)</sup>	UNIT	
$V_R$	Reverse Breakdown Voltage	$I_R = 100\ \mu\text{A}$			4.096		V	
	Reverse Breakdown Voltage Tolerance <sup>(3)</sup>	$I_R = 100\ \mu\text{A}$	LM4040CIM3 LM4040CIZ LM4040CIM7	$T_A = T_J = 25^\circ\text{C}$		$\pm 20$	mV	
				$T_A = T_J = T_{\text{MIN}}$ to $T_{\text{MAX}}$		$\pm 47$		
			LM4040DIM3 LM4040DIZ LM4040DIM7	$T_A = T_J = 25^\circ\text{C}$		$\pm 41$		
			$T_A = T_J = T_{\text{MIN}}$ to $T_{\text{MAX}}$		$\pm 81$			
$I_{\text{RMIN}}$	Minimum Operating Current		LM4040CIM3 LM4040CIZ LM4040CIM7	$T_A = T_J = 25^\circ\text{C}$	50	68	$\mu\text{A}$	
				$T_A = T_J = T_{\text{MIN}}$ to $T_{\text{MAX}}$		73		
			LM4040DIM3 LM4040DIZ LM4040DIM7	$T_A = T_J = 25^\circ\text{C}$	50	73		
				$T_A = T_J = T_{\text{MIN}}$ to $T_{\text{MAX}}$		78		
$\Delta V_R / \Delta T$	Average Reverse Breakdown Voltage Temperature Coefficient <sup>(3)</sup>	$I_R = 10\text{ mA}$		$T_A = T_J = 25^\circ\text{C}$		$\pm 30$	ppm/ $^\circ\text{C}$	
					$T_A = T_J = T_{\text{MIN}}$ to $T_{\text{MAX}}$			$\pm 20$
		$I_R = 1\text{ mA}$		LM4040CIM3 LM4040CIZ LM4040CIM7	$T_A = T_J = 25^\circ\text{C}$			$\pm 100$
					$T_A = T_J = T_{\text{MIN}}$ to $T_{\text{MAX}}$			$\pm 20$
				LM4040DIM3 LM4040DIZ LM4040DIM7	$T_A = T_J = 25^\circ\text{C}$			$\pm 150$
			$T_A = T_J = T_{\text{MIN}}$ to $T_{\text{MAX}}$		$\pm 20$			

(1) Limits are 100% production tested at  $25^\circ\text{C}$ . Limits over temperature are ensured through correlation using Statistical Quality Control (SQC) methods. The limits are used to calculate AOQL.

(2) Typicals are at  $T_J = 25^\circ\text{C}$  and represent most likely parametric norm.

(3) The (overtemperature) limit for Reverse Breakdown Voltage Tolerance is defined as the room temperature Reverse Breakdown Voltage Tolerance  $\pm[(\Delta V_R / \Delta T)(\text{max}\Delta T)(V_R)]$ . Where,  $\Delta V_R / \Delta T$  is the  $V_R$  temperature coefficient,  $\text{max}\Delta T$  is the maximum difference in temperature from the reference point of  $25^\circ\text{C}$  to  $T_{\text{MIN}}$  or  $T_{\text{MAX}}$ , and  $V_R$  is the reverse breakdown voltage. The total overtemperature tolerance for the different grades in the industrial temperature range where  $\text{max}\Delta T = 65^\circ\text{C}$  is shown below:

A-grade:  $\pm 0.75\% = \pm 0.1\% \pm 100\text{ ppm}/^\circ\text{C} \times 65^\circ\text{C}$

B-grade:  $\pm 0.85\% = \pm 0.2\% \pm 100\text{ ppm}/^\circ\text{C} \times 65^\circ\text{C}$

C-grade:  $\pm 1.15\% = \pm 0.5\% \pm 100\text{ ppm}/^\circ\text{C} \times 65^\circ\text{C}$

D-grade:  $\pm 1.98\% = \pm 1.0\% \pm 150\text{ ppm}/^\circ\text{C} \times 65^\circ\text{C}$

E-grade:  $\pm 2.98\% = \pm 2.0\% \pm 150\text{ ppm}/^\circ\text{C} \times 65^\circ\text{C}$

The total overtemperature tolerance for the different grades in the extended temperature range where  $\text{max}\Delta T = 100^\circ\text{C}$  is shown below:

C-grade:  $\pm 1.5\% = \pm 0.5\% \pm 100\text{ ppm}/^\circ\text{C} \times 100^\circ\text{C}$

D-grade:  $\pm 2.5\% = \pm 1.0\% \pm 150\text{ ppm}/^\circ\text{C} \times 100^\circ\text{C}$

E-grade:  $\pm 3.5\% = \pm 2.0\% \pm 150\text{ ppm}/^\circ\text{C} \times 100^\circ\text{C}$

Therefore, as an example, the A-grade 2.5-V LM4040-N has an overtemperature Reverse Breakdown Voltage tolerance of  $\pm 2.5\text{V} \times 0.75\% = \pm 19\text{ mV}$ .

### Electrical Characteristics: 4.1-V LM4040-N $V_R$ Tolerance Grades 'C' and 'D'; Temperature Grade 'I' (continued)

all other limits  $T_A = T_J = 25^\circ\text{C}$ . The grades C and D designate initial Reverse Breakdown Voltage tolerances of  $\pm 0.5\%$  and  $\pm 1\%$ , respectively.

PARAMETER		TEST CONDITIONS		MIN <sup>(1)</sup>	TYP <sup>(2)</sup>	MAX <sup>(1)</sup>	UNIT
$\Delta V_R / \Delta I_R$	Reverse Breakdown Voltage Change with Operating Current Change <sup>(4)</sup>	$I_{RMIN} \leq I_R \leq 1 \text{ mA}$	LM4040CIM3	$T_A = T_J = 25^\circ\text{C}$	0.5	0.9	mV
			LM4040CIZ	$T_A = T_J = T_{MIN} \text{ to } T_{MAX}$		1.2	
			LM4040DIM3	$T_A = T_J = 25^\circ\text{C}$	0.5	1.2	
			LM4040DIZ	$T_A = T_J = T_{MIN} \text{ to } T_{MAX}$		1.5	
	$1 \text{ mA} \leq I_R \leq 15 \text{ mA}$	LM4040CIM3	$T_A = T_J = 25^\circ\text{C}$	3	7		
		LM4040CIZ	$T_A = T_J = T_{MIN} \text{ to } T_{MAX}$		10		
		LM4040DIM3	$T_A = T_J = 25^\circ\text{C}$	3	9		
		LM4040DIZ	$T_A = T_J = T_{MIN} \text{ to } T_{MAX}$		13		
$Z_R$	Reverse Dynamic Impedance	$I_R = 1 \text{ mA}, f = 120 \text{ Hz}, I_{AC} = 0.1 I_R$	LM4040CIM3		0.5	1	$\Omega$
			LM4040CIZ				
$e_N$	Wideband Noise	$I_R = 100 \mu\text{A}$ $10 \text{ Hz} \leq f \leq 10 \text{ kHz}$	LM4040DIM3		0.5	1.3	$\mu\text{V}_{rms}$
			LM4040DIZ				
$\Delta V_R$	Reverse Breakdown Voltage Long Term Stability	$t = 1000 \text{ hrs}$ $T = 25^\circ\text{C} \pm 0.1^\circ\text{C}$ $I_R = 100 \mu\text{A}$	LM4040CIM3		120		ppm
			LM4040CIZ				
$V_{HYST}$	Thermal Hysteresis <sup>(5)</sup>	$\Delta T = -40^\circ\text{C} \text{ to } 125^\circ\text{C}$			0.08%		

- (4) Load regulation is measured on pulse basis from no load to the specified load current. Output changes due to die temperature change must be taken into account separately.
- (5) Thermal hysteresis is defined as the difference in voltage measured at  $+25^\circ\text{C}$  after cycling to temperature  $-40^\circ\text{C}$  and the  $25^\circ\text{C}$  measurement after cycling to temperature  $125^\circ\text{C}$ .

### 6.16 Electrical Characteristics: 5-V LM4040-N $V_R$ Tolerance Grades 'A' And 'B'; Temperature Grade 'I'

all other limits  $T_A = T_J = 25^\circ\text{C}$ . The grades A and B designate initial Reverse Breakdown Voltage tolerances of  $\pm 0.1\%$  and  $\pm 0.2\%$ , respectively.

PARAMETER		TEST CONDITIONS		MIN <sup>(1)</sup>	TYP <sup>(2)</sup>	MAX <sup>(1)</sup>	UNIT
$V_R$	Reverse Breakdown Voltage	$I_R = 100 \mu\text{A}$			5		V
	Reverse Breakdown Voltage Tolerance <sup>(3)</sup>	$I_R = 100 \mu\text{A}$	LM4040AIM3	$T_A = T_J = 25^\circ\text{C}$		$\pm 5$	mV
			LM4040AIZ	$T_A = T_J = T_{MIN} \text{ to } T_{MAX}$		$\pm 38$	
			LM4040BIM3	$T_A = T_J = 25^\circ\text{C}$		$\pm 10$	
LM4040BIZ			$T_A = T_J = T_{MIN} \text{ to } T_{MAX}$		$\pm 43$		

- (1) Limits are 100% production tested at  $25^\circ\text{C}$ . Limits over temperature are ensured through correlation using Statistical Quality Control (SQC) methods. The limits are used to calculate AOQL.
- (2) Typicals are at  $T_J = 25^\circ\text{C}$  and represent most likely parametric norm.
- (3) The (overtemperature) limit for Reverse Breakdown Voltage Tolerance is defined as the room temperature Reverse Breakdown Voltage Tolerance  $\pm[(\Delta V_R / \Delta T)(\max \Delta T)(V_R)]$ . Where,  $\Delta V_R / \Delta T$  is the  $V_R$  temperature coefficient,  $\max \Delta T$  is the maximum difference in temperature from the reference point of  $25^\circ\text{C}$  to  $T_{MIN}$  or  $T_{MAX}$ , and  $V_R$  is the reverse breakdown voltage. The total overtemperature tolerance for the different grades in the industrial temperature range where  $\max \Delta T = 65^\circ\text{C}$  is shown below:  
A-grade:  $\pm 0.75\% = \pm 0.1\% \pm 100 \text{ ppm}/^\circ\text{C} \times 65^\circ\text{C}$   
B-grade:  $\pm 0.85\% = \pm 0.2\% \pm 100 \text{ ppm}/^\circ\text{C} \times 65^\circ\text{C}$   
C-grade:  $\pm 1.15\% = \pm 0.5\% \pm 100 \text{ ppm}/^\circ\text{C} \times 65^\circ\text{C}$   
D-grade:  $\pm 1.98\% = \pm 1.0\% \pm 150 \text{ ppm}/^\circ\text{C} \times 65^\circ\text{C}$   
E-grade:  $\pm 2.98\% = \pm 2.0\% \pm 150 \text{ ppm}/^\circ\text{C} \times 65^\circ\text{C}$   
The total overtemperature tolerance for the different grades in the extended temperature range where  $\max \Delta T = 100^\circ\text{C}$  is shown below:  
C-grade:  $\pm 1.5\% = \pm 0.5\% \pm 100 \text{ ppm}/^\circ\text{C} \times 100^\circ\text{C}$   
D-grade:  $\pm 2.5\% = \pm 1.0\% \pm 150 \text{ ppm}/^\circ\text{C} \times 100^\circ\text{C}$   
E-grade:  $\pm 3.5\% = \pm 2.0\% \pm 150 \text{ ppm}/^\circ\text{C} \times 100^\circ\text{C}$   
Therefore, as an example, the A-grade 2.5-V LM4040-N has an overtemperature Reverse Breakdown Voltage tolerance of  $\pm 2.5\text{V} \times 0.75\% = \pm 19 \text{ mV}$ .

**Electrical Characteristics: 5-V LM4040-N  $V_R$  Tolerance Grades 'A' And 'B'; Temperature Grade 'I' (continued)**

all other limits  $T_A = T_J = 25^\circ\text{C}$ . The grades A and B designate initial Reverse Breakdown Voltage tolerances of  $\pm 0.1\%$  and  $\pm 0.2\%$ , respectively.

PARAMETER		TEST CONDITIONS		MIN <sup>(1)</sup>	TYP <sup>(2)</sup>	MAX <sup>(1)</sup>	UNIT	
$I_{RMIN}$	Minimum Operating Current	$T_A = T_J = 25^\circ\text{C}$			54	74	$\mu\text{A}$	
		$T_A = T_J = T_{MIN}$ to $T_{MAX}$				80		
$\Delta V_R / \Delta T$	Average Reverse Breakdown Voltage Temperature Coefficient <sup>(3)</sup>	$I_R = 10\text{ mA}$	$T_A = T_J = 25^\circ\text{C}$			$\pm 30$	ppm/ $^\circ\text{C}$	
			$T_A = T_J = T_{MIN}$ to $T_{MAX}$			$\pm 20$		
		$I_R = 1\text{ mA}$	$T_A = T_J = 25^\circ\text{C}$					$\pm 100$
		$I_R = 100\ \mu\text{A}$	$T_A = T_J = 25^\circ\text{C}$			$\pm 20$		
$\Delta V_R / \Delta I_R$	Reverse Breakdown Voltage Change with Operating Current Change <sup>(4)</sup>	$I_{RMIN} \leq I_R \leq 1\text{ mA}$	$T_A = T_J = 25^\circ\text{C}$			0.5	1	mV
			$T_A = T_J = T_{MIN}$ to $T_{MAX}$				1.4	
		$1\text{ mA} \leq I_R \leq 15\text{ mA}$	$T_A = T_J = 25^\circ\text{C}$			3.5	8	
			$T_A = T_J = T_{MIN}$ to $T_{MAX}$				12	
$Z_R$	Reverse Dynamic Impedance	$I_R = 1\text{ mA}$ , $f = 120\text{ Hz}$ , $I_{AC} = 0.1 I_R$				0.5	1.1	$\Omega$
$e_N$	Wideband Noise	$I_R = 100\ \mu\text{A}$ $10\text{ Hz} \leq f \leq 10\text{ kHz}$				80		$\mu\text{V}_{rms}$
$\Delta V_R$	Reverse Breakdown Voltage Long Term Stability	$t = 1000\text{ hrs}$ $T = 25^\circ\text{C} \pm 0.1^\circ\text{C}$ $I_R = 100\ \mu\text{A}$				120		ppm
$V_{HYST}$	Thermal Hysteresis <sup>(5)</sup>	$\Delta T = -40^\circ\text{C}$ to $125^\circ\text{C}$				0.08%		

(4) Load regulation is measured on pulse basis from no load to the specified load current. Output changes due to die temperature change must be taken into account separately.

(5) Thermal hysteresis is defined as the difference in voltage measured at  $+25^\circ\text{C}$  after cycling to temperature  $-40^\circ\text{C}$  and the  $25^\circ\text{C}$  measurement after cycling to temperature  $125^\circ\text{C}$ .

**6.17 Electrical Characteristics: 5-V LM4040-N  $V_R$  Tolerance Grades 'C' And 'D'; Temperature Grade 'I'**

all other limits  $T_A = T_J = 25^\circ\text{C}$ . The grades C and D designate initial Reverse Breakdown Voltage tolerances of  $\pm 0.5\%$  and  $\pm 1\%$ , respectively.

PARAMETER		TEST CONDITIONS		MIN <sup>(1)</sup>	TYP <sup>(2)</sup>	MAX <sup>(1)</sup>	UNIT
$V_R$	Reverse Breakdown Voltage	$I_R = 100\ \mu\text{A}$			5		V
	Reverse Breakdown Voltage Tolerance <sup>(3)</sup>	$I_R = 100\ \mu\text{A}$	LM4040CIM3	$T_A = T_J = 25^\circ\text{C}$		$\pm 25$	mV
			LM4040CIZ	$T_A = T_J = T_{MIN}$ to $T_{MAX}$		$\pm 58$	
			LM4040DIM3	$T_A = T_J = 25^\circ\text{C}$		$\pm 50$	
			LM4040DIZ	$T_A = T_J = T_{MIN}$ to $T_{MAX}$		$\pm 99$	
		LM4040DIM7	$T_A = T_J = T_{MIN}$ to $T_{MAX}$				

(1) Limits are 100% production tested at  $25^\circ\text{C}$ . Limits over temperature are ensured through correlation using Statistical Quality Control (SQC) methods. The limits are used to calculate AOQL.

(2) Typicals are at  $T_J = 25^\circ\text{C}$  and represent most likely parametric norm.

(3) The (overtemperature) limit for Reverse Breakdown Voltage Tolerance is defined as the room temperature Reverse Breakdown Voltage Tolerance  $\pm[(\Delta V_R / \Delta T)(\max \Delta T)(V_R)]$ . Where,  $\Delta V_R / \Delta T$  is the  $V_R$  temperature coefficient,  $\max \Delta T$  is the maximum difference in temperature from the reference point of  $25^\circ\text{C}$  to  $T_{MIN}$  or  $T_{MAX}$ , and  $V_R$  is the reverse breakdown voltage. The total overtemperature tolerance for the different grades in the industrial temperature range where  $\max \Delta T = 65^\circ\text{C}$  is shown below:

A-grade:  $\pm 0.75\% = \pm 0.1\% \pm 100\text{ ppm}/^\circ\text{C} \times 65^\circ\text{C}$

B-grade:  $\pm 0.85\% = \pm 0.2\% \pm 100\text{ ppm}/^\circ\text{C} \times 65^\circ\text{C}$

C-grade:  $\pm 1.15\% = \pm 0.5\% \pm 100\text{ ppm}/^\circ\text{C} \times 65^\circ\text{C}$

D-grade:  $\pm 1.98\% = \pm 1.0\% \pm 150\text{ ppm}/^\circ\text{C} \times 65^\circ\text{C}$

E-grade:  $\pm 2.98\% = \pm 2.0\% \pm 150\text{ ppm}/^\circ\text{C} \times 65^\circ\text{C}$

The total overtemperature tolerance for the different grades in the extended temperature range where  $\max \Delta T = 100^\circ\text{C}$  is shown below:

C-grade:  $\pm 1.5\% = \pm 0.5\% \pm 100\text{ ppm}/^\circ\text{C} \times 100^\circ\text{C}$

D-grade:  $\pm 2.5\% = \pm 1.0\% \pm 150\text{ ppm}/^\circ\text{C} \times 100^\circ\text{C}$

E-grade:  $\pm 3.5\% = \pm 2.0\% \pm 150\text{ ppm}/^\circ\text{C} \times 100^\circ\text{C}$

Therefore, as an example, the A-grade 2.5-V LM4040-N has an overtemperature Reverse Breakdown Voltage tolerance of  $\pm 2.5\text{ V} \times 0.75\% = \pm 19\text{ mV}$ .

**Electrical Characteristics: 5-V LM4040-N  $V_R$  Tolerance Grades 'C' And 'D'; Temperature Grade 'I' (continued)**

all other limits  $T_A = T_J = 25^\circ\text{C}$ . The grades C and D designate initial Reverse Breakdown Voltage tolerances of  $\pm 0.5\%$  and  $\pm 1\%$ , respectively.

PARAMETER	TEST CONDITIONS		MIN <sup>(1)</sup>	TYP <sup>(2)</sup>	MAX <sup>(1)</sup>	UNIT
$I_{RMIN}$ Minimum Operating Current		LM4040CIM3 LM4040CI2 LM4040CIM7	$T_A = T_J = 25^\circ\text{C}$	54	74	$\mu\text{A}$
			$T_A = T_J = T_{MIN}$ to $T_{MAX}$		80	
		LM4040DIM3 LM4040DI2 LM4040DIM7	$T_A = T_J = 25^\circ\text{C}$	54	79	
			$T_A = T_J = T_{MIN}$ to $T_{MAX}$		85	
$\Delta V_R/\Delta T$ Average Reverse Breakdown Voltage Temperature Coefficient <sup>(3)</sup>	$I_R = 10\text{ mA}$			$\pm 30$		$\text{ppm}/^\circ\text{C}$
	$I_R = 1\text{ mA}$	LM4040CIM3 LM4040CI2 LM4040CIM7	$T_A = T_J = 25^\circ\text{C}$	$\pm 20$	$\pm 100$	
			$T_A = T_J = T_{MIN}$ to $T_{MAX}$			
		LM4040DIM3 LM4040DI2 LM4040DIM7	$T_A = T_J = 25^\circ\text{C}$	$\pm 20$	$\pm 150$	
	$I_R = 100\ \mu\text{A}$			$\pm 20$		
$\Delta V_R/\Delta I_R$ Reverse Breakdown Voltage Change with Operating Current Change <sup>(4)</sup>	$I_{RMIN} \leq I_R \leq 1\text{ mA}$	LM4040CIM3 LM4040CI2 LM4040CIM7	$T_A = T_J = 25^\circ\text{C}$	0.5	1	$\text{mV}$
			$T_A = T_J = T_{MIN}$ to $T_{MAX}$		1.4	
		LM4040DIM3 LM4040DI2 LM4040DIM7	$T_A = T_J = 25^\circ\text{C}$	0.5	1.3	
		$T_A = T_J = T_{MIN}$ to $T_{MAX}$		1.8		
	$1\text{ mA} \leq I_R \leq 15\text{ mA}$	LM4040CIM3 LM4040CI2 LM4040CIM7	$T_A = T_J = 25^\circ\text{C}$	3.5	8	
			$T_A = T_J = T_{MIN}$ to $T_{MAX}$		12	
LM4040DIM3 LM4040DI2 LM4040DIM7		$T_A = T_J = 25^\circ\text{C}$	3.5	10		
		$T_A = T_J = T_{MIN}$ to $T_{MAX}$		15		
$Z_R$ Reverse Dynamic Impedance	$I_R = 1\text{ mA}$ , $f = 120\text{ Hz}$ , $I_{AC} = 0.1 I_R$		$T_A = T_J = 25^\circ\text{C}$	0.5	1.1	$\Omega$
			$T_A = T_J = T_{MIN}$ to $T_{MAX}$		1.5	
$e_N$ Wideband Noise	$I_R = 100\ \mu\text{A}$ $10\text{ Hz} \leq f \leq 10\text{ kHz}$			80		$\mu\text{V}_{rms}$
$\Delta V_R$ Reverse Breakdown Voltage Long Term Stability	$t = 1000\text{ hrs}$ $T = 25^\circ\text{C} \pm 0.1^\circ\text{C}$ $I_R = 100\ \mu\text{A}$			120		ppm
$V_{HYST}$ Thermal Hysteresis <sup>(5)</sup>	$\Delta T = -40^\circ\text{C}$ to $125^\circ\text{C}$			0.08%		

- (4) Load regulation is measured on pulse basis from no load to the specified load current. Output changes due to die temperature change must be taken into account separately.
- (5) Thermal hysteresis is defined as the difference in voltage measured at  $+25^\circ\text{C}$  after cycling to temperature  $-40^\circ\text{C}$  and the  $25^\circ\text{C}$  measurement after cycling to temperature  $125^\circ\text{C}$ .

## 6.18 Electrical Characteristics: 5-V LM4040-N $V_R$ Tolerance Grades 'C' And 'D'; Temperature Grade 'E'

all other limits  $T_A = T_J = 25^\circ\text{C}$ . The grades C and D designate initial Reverse Breakdown Voltage tolerances of  $\pm 0.5\%$  and  $\pm 1\%$ , respectively.

PARAMETER		TEST CONDITIONS		MIN <sup>(1)</sup>	TYP	MAX <sup>(1)</sup>	UNIT
$V_R$	Reverse Breakdown Voltage	$I_R = 100 \mu\text{A}$			5		V
	Reverse Breakdown Voltage Tolerance <sup>(2)</sup>	$I_R = 100 \mu\text{A}$	LM4040CEM3	$T_A = T_J = 25^\circ\text{C}$		$\pm 25$	mV
				$T_A = T_J = T_{\text{MIN}}$ to $T_{\text{MAX}}$		$\pm 75$	
			LM4040DEM3	$T_A = T_J = 25^\circ\text{C}$		$\pm 50$	
$T_A = T_J = T_{\text{MIN}}$ to $T_{\text{MAX}}$		$\pm 125$					
$I_{\text{RMIN}}$	Minimum Operating Current		LM4040CEM3	$T_A = T_J = 25^\circ\text{C}$	54	74	$\mu\text{A}$
				$T_A = T_J = T_{\text{MIN}}$ to $T_{\text{MAX}}$		83	
			LM4040DEM3	$T_A = T_J = 25^\circ\text{C}$	54	79	
				$T_A = T_J = T_{\text{MIN}}$ to $T_{\text{MAX}}$		88	
$\frac{\Delta V_R}{\Delta T}$	Average Reverse Breakdown Voltage Temperature Coefficient <sup>(2)</sup>	$I_R = 10 \text{ mA}$			$\pm 30$		ppm/ $^\circ\text{C}$
		$I_R = 1 \text{ mA}$	LM4040CEM3	$T_A = T_J = 25^\circ\text{C}$		$\pm 20$	
				$T_A = T_J = T_{\text{MIN}}$ to $T_{\text{MAX}}$		$\pm 100$	
			LM4040DEM3	$T_A = T_J = 25^\circ\text{C}$		$\pm 20$	
$T_A = T_J = T_{\text{MIN}}$ to $T_{\text{MAX}}$		$\pm 150$					
$\frac{\Delta V_R}{\Delta I_R}$	Reverse Breakdown Voltage Change with Operating Current Change <sup>(3)</sup>	$I_{\text{RMIN}} \leq I_R \leq 1 \text{ mA}$	LM4040CEM3	$T_A = T_J = 25^\circ\text{C}$	0.5	1	mV
				$T_A = T_J = T_{\text{MIN}}$ to $T_{\text{MAX}}$		1.4	
			LM4040DEM3	$T_A = T_J = 25^\circ\text{C}$	0.5	1	
		$T_A = T_J = T_{\text{MIN}}$ to $T_{\text{MAX}}$			1.8		
		$1 \text{ mA} \leq I_R \leq 15 \text{ mA}$	LM4040CEM3	$T_A = T_J = 25^\circ\text{C}$	3.5	8	
				$T_A = T_J = T_{\text{MIN}}$ to $T_{\text{MAX}}$		12	
LM4040DEM3	$T_A = T_J = 25^\circ\text{C}$		3.5	8			
	$T_A = T_J = T_{\text{MIN}}$ to $T_{\text{MAX}}$		15				
$Z_R$	Reverse Dynamic Impedance	$I_R = 1 \text{ mA}$ , $f = 120 \text{ Hz}$ , $I_{\text{AC}} = 0.1 I_R$			0.5	1.1	$\Omega$
$e_N$	Wideband Noise	$I_R = 100 \mu\text{A}$ $10 \text{ Hz} \leq f \leq 10 \text{ kHz}$			80		$\mu\text{V}_{\text{rms}}$
$\Delta V_R$	Reverse Breakdown Voltage Long Term Stability	$t = 1000 \text{ hrs}$ $T = 25^\circ\text{C} \pm 0.1^\circ\text{C}$ $I_R = 100 \mu\text{A}$			120		ppm
$V_{\text{HYST}}$	Thermal Hysteresis <sup>(4)</sup>	$\Delta T = -40^\circ\text{C}$ to $125^\circ\text{C}$			0.08%		

- (1) Limits are 100% production tested at  $25^\circ\text{C}$ . Limits over temperature are ensured through correlation using Statistical Quality Control (SQC) methods. The limits are used to calculate AOQL.
- (2) The (overtemperature) limit for Reverse Breakdown Voltage Tolerance is defined as the room temperature Reverse Breakdown Voltage Tolerance  $\pm[(\Delta V_R/\Delta T)(\text{max}\Delta T)(V_R)]$ . Where,  $\Delta V_R/\Delta T$  is the  $V_R$  temperature coefficient,  $\text{max}\Delta T$  is the maximum difference in temperature from the reference point of  $25^\circ\text{C}$  to  $T_{\text{MIN}}$  or  $T_{\text{MAX}}$ , and  $V_R$  is the reverse breakdown voltage. The total overtemperature tolerance for the different grades in the industrial temperature range where  $\text{max}\Delta T = 65^\circ\text{C}$  is shown below:  
 A-grade:  $\pm 0.75\% = \pm 0.1\% \pm 100 \text{ ppm}/^\circ\text{C} \times 65^\circ\text{C}$   
 B-grade:  $\pm 0.85\% = \pm 0.2\% \pm 100 \text{ ppm}/^\circ\text{C} \times 65^\circ\text{C}$   
 C-grade:  $\pm 1.15\% = \pm 0.5\% \pm 100 \text{ ppm}/^\circ\text{C} \times 65^\circ\text{C}$   
 D-grade:  $\pm 1.98\% = \pm 1.0\% \pm 150 \text{ ppm}/^\circ\text{C} \times 65^\circ\text{C}$   
 E-grade:  $\pm 2.98\% = \pm 2.0\% \pm 150 \text{ ppm}/^\circ\text{C} \times 65^\circ\text{C}$   
 The total overtemperature tolerance for the different grades in the extended temperature range where  $\text{max}\Delta T = 100^\circ\text{C}$  is shown below:  
 C-grade:  $\pm 1.5\% = \pm 0.5\% \pm 100 \text{ ppm}/^\circ\text{C} \times 100^\circ\text{C}$   
 D-grade:  $\pm 2.5\% = \pm 1.0\% \pm 150 \text{ ppm}/^\circ\text{C} \times 100^\circ\text{C}$   
 E-grade:  $\pm 3.5\% = \pm 2.0\% \pm 150 \text{ ppm}/^\circ\text{C} \times 100^\circ\text{C}$   
 Therefore, as an example, the A-grade 2.5-V LM4040-N has an overtemperature Reverse Breakdown Voltage tolerance of  $\pm 2.5\% \times 0.75\% = \pm 19 \text{ mV}$ .
- (3) Load regulation is measured on pulse basis from no load to the specified load current. Output changes due to die temperature change must be taken into account separately.
- (4) Thermal hysteresis is defined as the difference in voltage measured at  $+25^\circ\text{C}$  after cycling to temperature  $-40^\circ\text{C}$  and the  $25^\circ\text{C}$  measurement after cycling to temperature  $125^\circ\text{C}$ .

## 6.19 Electrical Characteristics: 8.2-V LM4040-N $V_R$ Tolerance Grades 'A' And 'B'; Temperature Grade 'I'

all other limits  $T_A = T_J = 25^\circ\text{C}$ . The grades A and B designate initial Reverse Breakdown Voltage tolerances of  $\pm 0.1\%$  and  $\pm 0.2\%$ , respectively.

PARAMETER		TEST CONDITIONS		MIN <sup>(1)</sup>	TYP <sup>(2)</sup>	MAX <sup>(1)</sup>	UNIT
$V_R$	Reverse Breakdown Voltage	$I_R = 150 \mu\text{A}$			8.192		V
	Reverse Breakdown Voltage Tolerance <sup>(3)</sup>	$I_R = 150 \mu\text{A}$	LM4040AIM3	$T_A = T_J = 25^\circ\text{C}$		$\pm 8.2$	mV
			LM4040AIZ	$T_A = T_J = T_{\text{MIN}}$ to $T_{\text{MAX}}$		$\pm 61$	
			LM4040BIM3	$T_A = T_J = 25^\circ\text{C}$		$\pm 16$	
LM4040BIZ	$T_A = T_J = T_{\text{MIN}}$ to $T_{\text{MAX}}$		$\pm 70$				
$I_{\text{RMIN}}$	Minimum Operating Current		$T_A = T_J = 25^\circ\text{C}$		67	91	$\mu\text{A}$
			$T_A = T_J = T_{\text{MIN}}$ to $T_{\text{MAX}}$			95	
$\Delta V_R/\Delta T$	Average Reverse Breakdown Voltage Temperature Coefficient <sup>(3)</sup>	$I_R = 10 \text{ mA}$			$\pm 40$		ppm/ $^\circ\text{C}$
		$I_R = 1 \text{ mA}$	$T_A = T_J = 25^\circ\text{C}$		$\pm 20$		
			$T_A = T_J = T_{\text{MIN}}$ to $T_{\text{MAX}}$			$\pm 100$	
$\Delta V_R/\Delta I_R$	Reverse Breakdown Voltage Change with Operating Current Change <sup>(4)</sup>	$I_{\text{RMIN}} \leq I_R \leq 1 \text{ mA}$	$T_A = T_J = 25^\circ\text{C}$		0.6	1.3	mV
			$T_A = T_J = T_{\text{MIN}}$ to $T_{\text{MAX}}$			2.5	
		$1 \text{ mA} \leq I_R \leq 15 \text{ mA}$	$T_A = T_J = 25^\circ\text{C}$		7	10	
			$T_A = T_J = T_{\text{MIN}}$ to $T_{\text{MAX}}$			18	
$Z_R$	Reverse Dynamic Impedance	$I_R = 1 \text{ mA}$ , $f = 120 \text{ Hz}$ , $I_{\text{AC}} = 0.1 I_R$			0.6	1.5	$\Omega$
$e_N$	Wideband Noise	$I_R = 150 \mu\text{A}$ $10 \text{ Hz} \leq f \leq 10 \text{ kHz}$			130		$\mu\text{V}_{\text{rms}}$
$\Delta V_R$	Reverse Breakdown Voltage Long Term Stability	$t = 1000 \text{ hrs}$ $T = 25^\circ\text{C} \pm 0.1^\circ\text{C}$ $I_R = 150 \mu\text{A}$			120		ppm
$V_{\text{HYST}}$	Thermal Hysteresis <sup>(5)</sup>	$\Delta T = -40^\circ\text{C}$ to $125^\circ\text{C}$			0.08%		

- (1) Limits are 100% production tested at  $25^\circ\text{C}$ . Limits over temperature are ensured through correlation using Statistical Quality Control (SQC) methods. The limits are used to calculate AOQL.
- (2) Typicals are at  $T_J = 25^\circ\text{C}$  and represent most likely parametric norm.
- (3) The (overtemperature) limit for Reverse Breakdown Voltage Tolerance is defined as the room temperature Reverse Breakdown Voltage Tolerance  $\pm[(\Delta V_R/\Delta T)(\text{max}\Delta T)(V_R)]$ . Where,  $\Delta V_R/\Delta T$  is the  $V_R$  temperature coefficient,  $\text{max}\Delta T$  is the maximum difference in temperature from the reference point of  $25^\circ\text{C}$  to  $T_{\text{MIN}}$  or  $T_{\text{MAX}}$ , and  $V_R$  is the reverse breakdown voltage. The total overtemperature tolerance for the different grades in the industrial temperature range where  $\text{max}\Delta T = 65^\circ\text{C}$  is shown below:  
A-grade:  $\pm 0.75\% = \pm 0.1\% \pm 100 \text{ ppm}/^\circ\text{C} \times 65^\circ\text{C}$   
B-grade:  $\pm 0.85\% = \pm 0.2\% \pm 100 \text{ ppm}/^\circ\text{C} \times 65^\circ\text{C}$   
C-grade:  $\pm 1.15\% = \pm 0.5\% \pm 100 \text{ ppm}/^\circ\text{C} \times 65^\circ\text{C}$   
D-grade:  $\pm 1.98\% = \pm 1.0\% \pm 150 \text{ ppm}/^\circ\text{C} \times 65^\circ\text{C}$   
E-grade:  $\pm 2.98\% = \pm 2.0\% \pm 150 \text{ ppm}/^\circ\text{C} \times 65^\circ\text{C}$   
The total overtemperature tolerance for the different grades in the extended temperature range where  $\text{max}\Delta T = 100^\circ\text{C}$  is shown below:  
C-grade:  $\pm 1.5\% = \pm 0.5\% \pm 100 \text{ ppm}/^\circ\text{C} \times 100^\circ\text{C}$   
D-grade:  $\pm 2.5\% = \pm 1.0\% \pm 150 \text{ ppm}/^\circ\text{C} \times 100^\circ\text{C}$   
E-grade:  $\pm 3.5\% = \pm 2.0\% \pm 150 \text{ ppm}/^\circ\text{C} \times 100^\circ\text{C}$   
Therefore, as an example, the A-grade 2.5-V LM4040-N has an overtemperature Reverse Breakdown Voltage tolerance of  $\pm 2.5V \times 0.75\% = \pm 19 \text{ mV}$ .
- (4) Load regulation is measured on pulse basis from no load to the specified load current. Output changes due to die temperature change must be taken into account separately.
- (5) Thermal hysteresis is defined as the difference in voltage measured at  $+25^\circ\text{C}$  after cycling to temperature  $-40^\circ\text{C}$  and the  $25^\circ\text{C}$  measurement after cycling to temperature  $125^\circ\text{C}$ .

## 6.20 Electrical Characteristics: 8.2-V Lm4040-N $V_R$ Tolerance Grades 'C' And 'D'; Temperature Grade 'I'

all other limits  $T_A = T_J = 25^\circ\text{C}$ . The grades C and D designate initial Reverse Breakdown Voltage tolerances of  $\pm 0.5\%$  and  $\pm 1\%$ , respectively.

PARAMETER		TEST CONDITIONS		MIN <sup>(1)</sup>	TYP <sup>(2)</sup>	MAX <sup>(1)</sup>	UNIT	
$V_R$	Reverse Breakdown Voltage	$I_R = 150 \mu\text{A}$			8.192		V	
	Reverse Breakdown Voltage Tolerance <sup>(3)</sup>	$I_R = 150 \mu\text{A}$	LM4040CIM3 LM4040CIZ	$T_A = T_J = 25^\circ\text{C}$		$\pm 41$	mV	
				$T_A = T_J = T_{\text{MIN}}$ to $T_{\text{MAX}}$		$\pm 94$		
			LM4040DIM3 LM4040DIZ	$T_A = T_J = 25^\circ\text{C}$		$\pm 82$		
			$T_A = T_J = T_{\text{MIN}}$ to $T_{\text{MAX}}$		$\pm 162$			
$I_{\text{RMIN}}$	Minimum Operating Current		LM4040CIM3 LM4040CIZ	$T_A = T_J = 25^\circ\text{C}$		67	$\mu\text{A}$	
				$T_A = T_J = T_{\text{MIN}}$ to $T_{\text{MAX}}$		95		
			LM4040DIM3 LM4040DIZ	$T_A = T_J = 25^\circ\text{C}$		67		
				$T_A = T_J = T_{\text{MIN}}$ to $T_{\text{MAX}}$		96		
			$T_A = T_J = T_{\text{MIN}}$ to $T_{\text{MAX}}$		100			
$\Delta V_R/\Delta T$	Average Reverse Breakdown Voltage Temperature Coefficient <sup>(3)</sup>	$I_R = 10 \text{ mA}$	LM4040CIM3 LM4040CIZ	$T_A = T_J = 25^\circ\text{C}$		$\pm 40$	ppm/ $^\circ\text{C}$	
					$T_A = T_J = T_{\text{MIN}}$ to $T_{\text{MAX}}$			$\pm 20$
				LM4040DIM3 LM4040DIZ	$T_A = T_J = 25^\circ\text{C}$			$\pm 100$
					$T_A = T_J = T_{\text{MIN}}$ to $T_{\text{MAX}}$			$\pm 20$
						$\pm 150$		
		$I_R = 1 \text{ mA}$						
		$I_R = 150 \mu\text{A}$				$\pm 20$		
$\Delta V_R/\Delta I_R$	Reverse Breakdown Voltage Change with Operating Current Change <sup>(4)</sup>	$I_{\text{RMIN}} \leq I_R \leq 1 \text{ mA}$	LM4040CIM3 LM4040CIZ	$T_A = T_J = 25^\circ\text{C}$		0.6	1.3	mV
					$T_A = T_J = T_{\text{MIN}}$ to $T_{\text{MAX}}$		2.5	
			LM4040DIM3 LM4040DIZ	$T_A = T_J = 25^\circ\text{C}$		0.6	1.7	
					$T_A = T_J = T_{\text{MIN}}$ to $T_{\text{MAX}}$		3	
		$1 \text{ mA} \leq I_R \leq 15 \text{ mA}$	LM4040CIM3 LM4040CIZ	$T_A = T_J = 25^\circ\text{C}$		7	10	
					$T_A = T_J = T_{\text{MIN}}$ to $T_{\text{MAX}}$		18	
			LM4040DIM3 LM4040DIZ	$T_A = T_J = 25^\circ\text{C}$		7	15	
					$T_A = T_J = T_{\text{MIN}}$ to $T_{\text{MAX}}$		24	
$Z_R$	Reverse Dynamic Impedance	$I_R = 1 \text{ mA}$ , $f = 120 \text{ Hz}$ , $I_{\text{AC}} = 0.1 I_R$	LM4040CIM3 LM4040CIZ		0.6	1.5	$\Omega$	
			LM4040DIM3 LM4040DIZ		0.6	1.9		
$e_N$	Wideband Noise	$I_R = 150 \mu\text{A}$ $10 \text{ Hz} \leq f \leq 10 \text{ kHz}$			130		$\mu\text{V}_{\text{rms}}$	
$\Delta V_R$	Reverse Breakdown Voltage Long Term Stability	$t = 1000 \text{ hrs}$ $T = 25^\circ\text{C} \pm 0.1^\circ\text{C}$ $I_R = 150 \mu\text{A}$			120		ppm	
$V_{\text{HYST}}$	Thermal Hysteresis <sup>(5)</sup>	$\Delta T = -40^\circ\text{C}$ to $125^\circ\text{C}$			0.08%			

- (1) Limits are 100% production tested at  $25^\circ\text{C}$ . Limits over temperature are ensured through correlation using Statistical Quality Control (SQC) methods. The limits are used to calculate AOQL.
- (2) Typicals are at  $T_J = 25^\circ\text{C}$  and represent most likely parametric norm.
- (3) The (overtemperature) limit for Reverse Breakdown Voltage Tolerance is defined as the room temperature Reverse Breakdown Voltage Tolerance  $\pm[(\Delta V_R/\Delta T)(\text{max}\Delta T)(V_R)]$ . Where,  $\Delta V_R/\Delta T$  is the  $V_R$  temperature coefficient,  $\text{max}\Delta T$  is the maximum difference in temperature from the reference point of  $25^\circ\text{C}$  to  $T_{\text{MIN}}$  or  $T_{\text{MAX}}$ , and  $V_R$  is the reverse breakdown voltage. The total overtemperature tolerance for the different grades in the industrial temperature range where  $\text{max}\Delta T = 65^\circ\text{C}$  is shown below:  
 A-grade:  $\pm 0.75\% = \pm 0.1\% \pm 100 \text{ ppm}/^\circ\text{C} \times 65^\circ\text{C}$   
 B-grade:  $\pm 0.85\% = \pm 0.2\% \pm 100 \text{ ppm}/^\circ\text{C} \times 65^\circ\text{C}$   
 C-grade:  $\pm 1.15\% = \pm 0.5\% \pm 100 \text{ ppm}/^\circ\text{C} \times 65^\circ\text{C}$   
 D-grade:  $\pm 1.98\% = \pm 1.0\% \pm 150 \text{ ppm}/^\circ\text{C} \times 65^\circ\text{C}$   
 E-grade:  $\pm 2.98\% = \pm 2.0\% \pm 150 \text{ ppm}/^\circ\text{C} \times 65^\circ\text{C}$   
 The total overtemperature tolerance for the different grades in the extended temperature range where  $\text{max}\Delta T = 100^\circ\text{C}$  is shown below:  
 C-grade:  $\pm 1.5\% = \pm 0.5\% \pm 100 \text{ ppm}/^\circ\text{C} \times 100^\circ\text{C}$   
 D-grade:  $\pm 2.5\% = \pm 1.0\% \pm 150 \text{ ppm}/^\circ\text{C} \times 100^\circ\text{C}$   
 E-grade:  $\pm 3.5\% = \pm 2.0\% \pm 150 \text{ ppm}/^\circ\text{C} \times 100^\circ\text{C}$   
 Therefore, as an example, the A-grade 2.5-V LM4040-N has an overtemperature Reverse Breakdown Voltage tolerance of  $\pm 2.5\text{V} \times 0.75\% = \pm 19 \text{ mV}$ .
- (4) Load regulation is measured on pulse basis from no load to the specified load current. Output changes due to die temperature change must be taken into account separately.
- (5) Thermal hysteresis is defined as the difference in voltage measured at  $+25^\circ\text{C}$  after cycling to temperature  $-40^\circ\text{C}$  and the  $25^\circ\text{C}$  measurement after cycling to temperature  $125^\circ\text{C}$ .

## 6.21 Electrical Characteristics: 10-V LM4040-N $V_R$ Tolerance Grades 'A' And 'B'; Temperature Grade 'I'

all other limits  $T_A = T_J = 25^\circ\text{C}$ . The grades A and B designate initial Reverse Breakdown Voltage tolerances of  $\pm 0.1\%$  and  $\pm 0.2\%$ , respectively.

PARAMETER		TEST CONDITIONS		MIN <sup>(1)</sup>	TYP <sup>(2)</sup>	MAX <sup>(1)</sup>	UNIT
$V_R$	Reverse Breakdown Voltage	$I_R = 150 \mu\text{A}$			10		V
	Reverse Breakdown Voltage Tolerance <sup>(3)</sup>	$I_R = 150 \mu\text{A}$	LM4040AIM3 LM4040AIZ	$T_A = T_J = 25^\circ\text{C}$		$\pm 10$	mV
				$T_A = T_J = T_{\text{MIN}}$ to $T_{\text{MAX}}$		$\pm 75$	
			LM4040BIM3 LM4040BIZ	$T_A = T_J = 25^\circ\text{C}$		$\pm 20$	
			$T_A = T_J = T_{\text{MIN}}$ to $T_{\text{MAX}}$		$\pm 85$		
$I_{\text{RMIN}}$	Minimum Operating Current		$T_A = T_J = 25^\circ\text{C}$		75	100	$\mu\text{A}$
			$T_A = T_J = T_{\text{MIN}}$ to $T_{\text{MAX}}$			103	
$\Delta V_R/\Delta T$	Average Reverse Breakdown Voltage Temperature Coefficient <sup>(3)</sup>	$I_R = 10 \text{ mA}$			$\pm 40$		ppm/ $^\circ\text{C}$
		$I_R = 1 \text{ mA}$	$T_A = T_J = 25^\circ\text{C}$		$\pm 20$		
			$T_A = T_J = T_{\text{MIN}}$ to $T_{\text{MAX}}$			$\pm 100$	
$I_R = 150 \mu\text{A}$				$\pm 20$			
$\Delta V_R/\Delta I_R$	Reverse Breakdown Voltage Change with Operating Current Change <sup>(4)</sup>	$I_{\text{RMIN}} \leq I_R \leq 1 \text{ mA}$	$T_A = T_J = 25^\circ\text{C}$		0.8	1.5	mV
			$T_A = T_J = T_{\text{MIN}}$ to $T_{\text{MAX}}$			3.5	
		$1 \text{ mA} \leq I_R \leq 15 \text{ mA}$	$T_A = T_J = 25^\circ\text{C}$		8	12	
			$T_A = T_J = T_{\text{MIN}}$ to $T_{\text{MAX}}$			23	
$Z_R$	Reverse Dynamic Impedance	$I_R = 1 \text{ mA}$ , $f = 120 \text{ Hz}$ , $I_{\text{AC}} = 0.1 I_R$			0.7	1.7	$\Omega$
$e_N$	Wideband Noise	$I_R = 150 \mu\text{A}$ $10 \text{ Hz} \leq f \leq 10 \text{ kHz}$			180		$\mu\text{V}_{\text{rms}}$
$\Delta V_R$	Reverse Breakdown Voltage Long Term Stability	$t = 1000 \text{ hrs}$ $T = 25^\circ\text{C} \pm 0.1^\circ\text{C}$ $I_R = 150 \mu\text{A}$			120		ppm
$V_{\text{HYST}}$	Thermal Hysteresis <sup>(5)</sup>	$\Delta T = -40^\circ\text{C}$ to $125^\circ\text{C}$			0.08%		

- (1) Limits are 100% production tested at  $25^\circ\text{C}$ . Limits over temperature are ensured through correlation using Statistical Quality Control (SQC) methods. The limits are used to calculate AOQL.
- (2) Typicals are at  $T_J = 25^\circ\text{C}$  and represent most likely parametric norm.
- (3) The (overtemperature) limit for Reverse Breakdown Voltage Tolerance is defined as the room temperature Reverse Breakdown Voltage Tolerance  $\pm[(\Delta V_R/\Delta T)(\text{max}\Delta T)(V_R)]$ . Where,  $\Delta V_R/\Delta T$  is the  $V_R$  temperature coefficient,  $\text{max}\Delta T$  is the maximum difference in temperature from the reference point of  $25^\circ\text{C}$  to  $T_{\text{MIN}}$  or  $T_{\text{MAX}}$ , and  $V_R$  is the reverse breakdown voltage. The total overtemperature tolerance for the different grades in the industrial temperature range where  $\text{max}\Delta T = 65^\circ\text{C}$  is shown below:  
A-grade:  $\pm 0.75\% = \pm 0.1\% \pm 100 \text{ ppm}/^\circ\text{C} \times 65^\circ\text{C}$   
B-grade:  $\pm 0.85\% = \pm 0.2\% \pm 100 \text{ ppm}/^\circ\text{C} \times 65^\circ\text{C}$   
C-grade:  $\pm 1.15\% = \pm 0.5\% \pm 100 \text{ ppm}/^\circ\text{C} \times 65^\circ\text{C}$   
D-grade:  $\pm 1.98\% = \pm 1.0\% \pm 150 \text{ ppm}/^\circ\text{C} \times 65^\circ\text{C}$   
E-grade:  $\pm 2.98\% = \pm 2.0\% \pm 150 \text{ ppm}/^\circ\text{C} \times 65^\circ\text{C}$   
The total overtemperature tolerance for the different grades in the extended temperature range where  $\text{max}\Delta T = 100^\circ\text{C}$  is shown below:  
C-grade:  $\pm 1.5\% = \pm 0.5\% \pm 100 \text{ ppm}/^\circ\text{C} \times 100^\circ\text{C}$   
D-grade:  $\pm 2.5\% = \pm 1.0\% \pm 150 \text{ ppm}/^\circ\text{C} \times 100^\circ\text{C}$   
E-grade:  $\pm 3.5\% = \pm 2.0\% \pm 150 \text{ ppm}/^\circ\text{C} \times 100^\circ\text{C}$   
Therefore, as an example, the A-grade 2.5-V LM4040-N has an overtemperature Reverse Breakdown Voltage tolerance of  $\pm 2.5\% \times 0.75\% = \pm 19 \text{ mV}$ .
- (4) Load regulation is measured on pulse basis from no load to the specified load current. Output changes due to die temperature change must be taken into account separately.
- (5) Thermal hysteresis is defined as the difference in voltage measured at  $+25^\circ\text{C}$  after cycling to temperature  $-40^\circ\text{C}$  and the  $25^\circ\text{C}$  measurement after cycling to temperature  $125^\circ\text{C}$ .

## 6.22 Electrical Characteristics: 10-V LM4040-N $V_R$ Tolerance Grades 'C' And 'D'; Temperature Grade 'I'

all other limits  $T_A = T_J = 25^\circ\text{C}$ . The grades C and D designate initial Reverse Breakdown Voltage tolerances of  $\pm 0.5\%$  and  $\pm 1\%$ , respectively.

PARAMETER		TEST CONDITIONS		MIN <sup>(1)</sup>	TYP <sup>(2)</sup>	MAX <sup>(1)</sup>	UNIT
$V_R$	Reverse Breakdown Voltage	$I_R = 150\ \mu\text{A}$			10		V
	Reverse Breakdown Voltage Tolerance <sup>(3)</sup>	$I_R = 150\ \mu\text{A}$	LM4040CIM3 LM4040CIZ	$T_A = T_J = 25^\circ\text{C}$		$\pm 50$	mV
				$T_A = T_J = T_{\text{MIN}}$ to $T_{\text{MAX}}$		$\pm 115$	
			LM4040DIM3 LM4040DIZ	$T_A = T_J = 25^\circ\text{C}$		$\pm 100$	
			$T_A = T_J = T_{\text{MIN}}$ to $T_{\text{MAX}}$		$\pm 198$		
$I_{\text{RMIN}}$	Minimum Operating Current		LM4040CIM3 LM4040CIZ	$T_A = T_J = 25^\circ\text{C}$	75	100	$\mu\text{A}$
				$T_A = T_J = T_{\text{MIN}}$ to $T_{\text{MAX}}$		103	
			LM4040DIM3 LM4040DIZ	$T_A = T_J = 25^\circ\text{C}$	75	110	
				$T_A = T_J = T_{\text{MIN}}$ to $T_{\text{MAX}}$		113	
$\Delta V_R/\Delta T$	Average Reverse Breakdown Voltage Temperature Coefficient <sup>(3)</sup>	$I_R = 10\ \text{mA}$			$\pm 40$		ppm/ $^\circ\text{C}$
		$I_R = 1\ \text{mA}$	LM4040CIM3 LM4040CIZ	$T_A = T_J = 25^\circ\text{C}$	$\pm 20$		
				$T_A = T_J = T_{\text{MIN}}$ to $T_{\text{MAX}}$		$\pm 100$	
			LM4040DIM3 LM4040DIZ	$T_A = T_J = 25^\circ\text{C}$	$\pm 20$		
			$T_A = T_J = T_{\text{MIN}}$ to $T_{\text{MAX}}$		$\pm 150$		
$\Delta V_R/\Delta I_R$	Reverse Breakdown Voltage Change with Operating Current Change <sup>(4)</sup>	$I_{\text{RMIN}} \leq I_R \leq 1\ \text{mA}$	LM4040CIM3 LM4040CIZ	$T_A = T_J = 25^\circ\text{C}$	0.8	1.5	mV
				$T_A = T_J = T_{\text{MIN}}$ to $T_{\text{MAX}}$		3.5	
			LM4040DIM3 LM4040DIZ	$T_A = T_J = 25^\circ\text{C}$	0.8	2	
			$T_A = T_J = T_{\text{MIN}}$ to $T_{\text{MAX}}$		4		
		$1\ \text{mA} \leq I_R \leq 15\ \text{mA}$	LM4040CIM3 LM4040CIZ	$T_A = T_J = 25^\circ\text{C}$	8	12	
				$T_A = T_J = T_{\text{MIN}}$ to $T_{\text{MAX}}$		23	
LM4040DIM3 LM4040DIZ	$T_A = T_J = 25^\circ\text{C}$		8	18			
			$T_A = T_J = T_{\text{MIN}}$ to $T_{\text{MAX}}$		29		
$Z_R$	Reverse Dynamic Impedance	$I_R = 1\ \text{mA}$ , $f = 120\ \text{Hz}$ , $I_{\text{AC}} = 0.1\ I_R$	LM4040CIM3 LM4040CIZ		0.7	1.7	$\Omega$
			LM4040DIM3 LM4040DIZ			2.3	
$e_N$	Wideband Noise	$I_R = 150\ \mu\text{A}$ $10\ \text{Hz} \leq f \leq 10\ \text{kHz}$			180		$\mu\text{V}_{\text{rms}}$
$\Delta V_R$	Reverse Breakdown Voltage Long Term Stability	$t = 1000\ \text{hrs}$ $T = 25^\circ\text{C} \pm 0.1^\circ\text{C}$ $I_R = 150\ \mu\text{A}$			120		ppm
$V_{\text{HYST}}$	Thermal Hysteresis <sup>(5)</sup>	$\Delta T = -40^\circ\text{C}$ to $125^\circ\text{C}$			0.08%		

- (1) Limits are 100% production tested at  $25^\circ\text{C}$ . Limits over temperature are ensured through correlation using Statistical Quality Control (SQC) methods. The limits are used to calculate AOQL.
- (2) Typical values are at  $T_J = 25^\circ\text{C}$  and represent most likely parametric norm.
- (3) The (overtemperature) limit for Reverse Breakdown Voltage Tolerance is defined as the room temperature Reverse Breakdown Voltage Tolerance  $\pm[(\Delta V_R/\Delta T)(\text{max}\Delta T)(V_R)]$ . Where,  $\Delta V_R/\Delta T$  is the  $V_R$  temperature coefficient,  $\text{max}\Delta T$  is the maximum difference in temperature from the reference point of  $25^\circ\text{C}$  to  $T_{\text{MIN}}$  or  $T_{\text{MAX}}$ , and  $V_R$  is the reverse breakdown voltage. The total overtemperature tolerance for the different grades in the industrial temperature range where  $\text{max}\Delta T = 65^\circ\text{C}$  is shown below:  
 A-grade:  $\pm 0.75\% = \pm 0.1\% \pm 100\ \text{ppm}/^\circ\text{C} \times 65^\circ\text{C}$   
 B-grade:  $\pm 0.85\% = \pm 0.2\% \pm 100\ \text{ppm}/^\circ\text{C} \times 65^\circ\text{C}$   
 C-grade:  $\pm 1.15\% = \pm 0.5\% \pm 100\ \text{ppm}/^\circ\text{C} \times 65^\circ\text{C}$   
 D-grade:  $\pm 1.98\% = \pm 1.0\% \pm 150\ \text{ppm}/^\circ\text{C} \times 65^\circ\text{C}$   
 E-grade:  $\pm 2.98\% = \pm 2.0\% \pm 150\ \text{ppm}/^\circ\text{C} \times 65^\circ\text{C}$   
 The total overtemperature tolerance for the different grades in the extended temperature range where  $\text{max}\Delta T = 100^\circ\text{C}$  is shown below:  
 C-grade:  $\pm 1.5\% = \pm 0.5\% \pm 100\ \text{ppm}/^\circ\text{C} \times 100^\circ\text{C}$   
 D-grade:  $\pm 2.5\% = \pm 1.0\% \pm 150\ \text{ppm}/^\circ\text{C} \times 100^\circ\text{C}$   
 E-grade:  $\pm 3.5\% = \pm 2.0\% \pm 150\ \text{ppm}/^\circ\text{C} \times 100^\circ\text{C}$   
 Therefore, as an example, the A-grade 2.5-V LM4040-N has an overtemperature Reverse Breakdown Voltage tolerance of  $\pm 2.5\ \text{V} \times 0.75\% = \pm 19\ \text{mV}$ .
- (4) Load regulation is measured on pulse basis from no load to the specified load current. Output changes due to die temperature change must be taken into account separately.
- (5) Thermal hysteresis is defined as the difference in voltage measured at  $+25^\circ\text{C}$  after cycling to temperature  $-40^\circ\text{C}$  and the  $25^\circ\text{C}$  measurement after cycling to temperature  $125^\circ\text{C}$ .

6.23 Typical Characteristics



Figure 1. Temperature Drift For Different Average Temperature Coefficient



Figure 2. Output Impedance vs Frequency



Figure 3. Output Impedance vs Frequency



Figure 4. Reverse Characteristics And Minimum Operating Current



Figure 5. Noise Voltage vs Frequency

### 6.23.1 Start-Up Characteristics

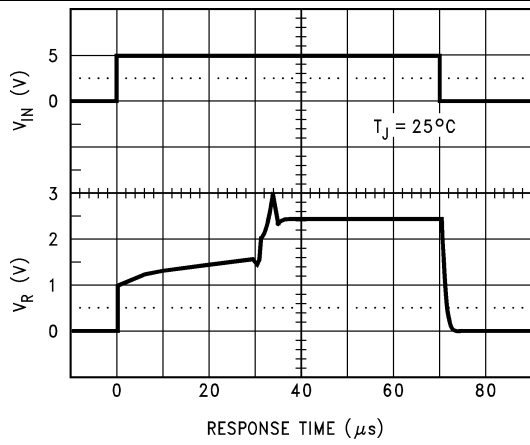

Figure 6. Input Voltage Step Response LM4040-N-2.5

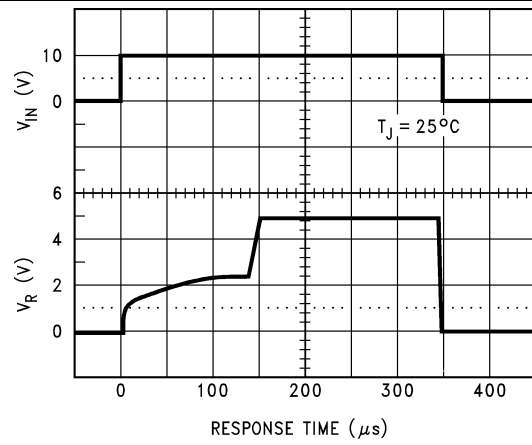
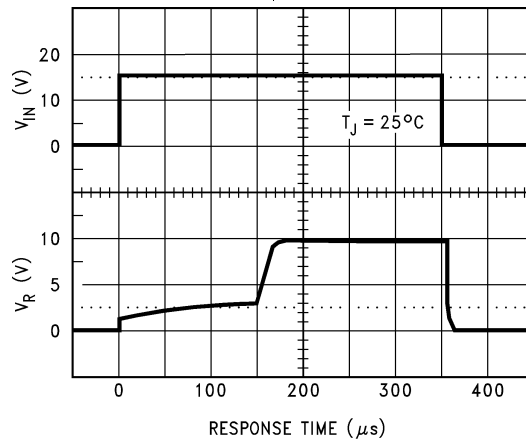

Figure 7. Input Voltage Step Response LM4040-N-5



$R_S = 30k$

Figure 8. Input Voltage Step Response LM4040-N-10

## 7 Parameter Measurement Information

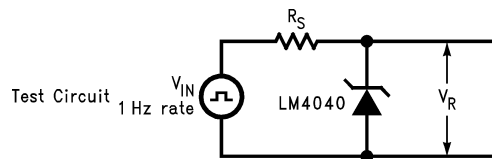

Figure 9. Test Circuit

## 8 Detailed Description

### 8.1 Overview

The LM4040 device is a precision micropower shunt voltage reference available in 7 different fixed-output voltage options and three different packages to meet small footprint requirements. The part is also available in five different tolerance grades.

### 8.2 Functional Block Diagram



### 8.3 Feature Description

The LM4040 device is effectively a precision Zener diode. The part requires a small quiescent current for regulation, and regulates the output voltage by shunting more or less current to ground, depending on input voltage and load. The only external component requirement is a resistor between the cathode and the input voltage to set the input current. An external capacitor can be used on the input or output, but is not required.

### 8.4 Device Functional Modes

The LM4040 device is a fixed output voltage part, where the feedback is internal. Therefore, the part can only operate in a closed loop mode and the output voltage cannot be adjusted. The output voltage will remain in regulation as long as  $I_R$  is between  $I_{RMIN}$ , see [Electrical Characteristics: 2-V LM4040-N  \$V\_R\$  Tolerance Grades 'A' And 'B'; Temperature Grade 'I'](#), and  $I_{RMAX}$ , 15 mA. Proper selection of the external resistor for input voltage range and load current range will ensure these conditions are met.

## 9 Application and Implementation

### NOTE

Information in the following applications sections is not part of the TI component specification, and TI does not warrant its accuracy or completeness. TI's customers are responsible for determining suitability of components for their purposes. Customers should validate and test their design implementation to confirm system functionality.

### 9.1 Application Information

The LM4040-N is a precision micropower curvature-corrected bandgap shunt voltage reference. For space critical applications, the LM4040-N is available in the sub-miniature SOT-23 and SC70 surface-mount package. The LM4040-N has been designed for stable operation without the need of an external capacitor connected between the + pin and the - pin. If, however, a bypass capacitor is used, the LM4040-N remains stable. Reducing design effort is the availability of several fixed reverse breakdown voltages: 2.048 V, 2.5 V, 3 V, 4.096 V, 5 V, 8.192 V, and 10 V. The minimum operating current increases from 60  $\mu$ A for the LM4040-N-2.048 and LM4040-N-2.5 to 100  $\mu$ A for the 10-V LM4040-N. All versions have a maximum operating current of 15 mA.

LM4040-Ns in the SOT-23 packages have a parasitic Schottky diode between pin 2 (-) and pin 3 (Die attach interface contact). Therefore, pin 3 of the SOT-23 package must be left floating or connected to pin 2.

LM4040-Ns in the SC70 have a parasitic Schottky diode between pin 1 (-) and pin 2 (Die attach interface contact). Therefore, pin 2 must be left floating or connected to pin 1.

The 4.096-V version allows single 5-V 12-bit ADCs or DACs to operate with an LSB equal to 1 mV. For 12-bit ADCs or DACs that operate on supplies of 10 V or greater, the 8.192-V version gives 2 mV per LSB.

The typical thermal hysteresis specification is defined as the change in 25°C voltage measured after thermal cycling. The device is thermal cycled to temperature -40°C and then measured at 25°C. Next the device is thermal cycled to temperature 125°C and again measured at 25°C. The resulting  $V_{OUT}$  delta shift between the 25°C measurements is thermal hysteresis. Thermal hysteresis is common in precision references and is induced by thermal-mechanical package stress. Changes in environmental storage temperature, operating temperature and board mounting temperature are all factors that can contribute to thermal hysteresis.

In a conventional shunt regulator application (Figure 10), an external series resistor ( $R_S$ ) is connected between the supply voltage and the LM4040-N.  $R_S$  determines the current that flows through the load ( $I_L$ ) and the LM4040-N ( $I_Q$ ). Since load current and supply voltage may vary,  $R_S$  should be small enough to supply at least the minimum acceptable  $I_Q$  to the LM4040-N even when the supply voltage is at its minimum and the load current is at its maximum value. When the supply voltage is at its maximum and  $I_L$  is at its minimum,  $R_S$  should be large enough so that the current flowing through the LM4040-N is less than 15 mA.

$R_S$  is determined by the supply voltage, ( $V_S$ ), the load and operating current, ( $I_L$  and  $I_Q$ ), and the LM4040-N's reverse breakdown voltage,  $V_R$ .

$$R_S = \frac{V_S - V_R}{I_L + I_Q} \quad (1)$$

### 9.2 Typical Applications

#### 9.2.1 Shunt Regulator



**Figure 10. Shunt Regulator Schematic**

## Typical Applications (continued)

### 9.2.1.1 Design Requirements

$$V_{IN} > V_{OUT}$$

Select  $R_S$  such that:

$$I_{RMIN} < I_R < I_{RMAX} \text{ where } I_{RMAX} = 15 \text{ mA}$$

See [Electrical Characteristics: 2-V LM4040-N  \$V\_R\$  Tolerance Grades 'A' And 'B'; Temperature Grade 'I'](#) for minimum operating current for each voltage option and grade.

### 9.2.1.2 Detailed Design Procedure

The resistor  $R_S$  must be selected such that current  $I_R$  will remain in the operational region of the part for the entire  $V_{IN}$  range and load current range. The two extremes to consider are  $V_{IN}$  at its minimum, and the load at its maximum, where  $R_S$  must be small enough for  $I_R$  to remain above  $I_{RMIN}$ . The other extreme is  $V_{IN}$  at its maximum, and the load at its minimum, where  $R_S$  must be large enough to maintain  $I_R < I_{RMAX}$ . For most designs,  $0.1 \text{ mA} \leq I_R \leq 1 \text{ mA}$  is a good starting point.

Use [Equation 2](#) and [Equation 3](#) to set  $R_S$  between  $R_{S\_MIN}$  and  $R_{S\_MAX}$ .

$$R_{S\_MIN} = \frac{V_{IN\_MAX} - V_{OUT}}{I_{LOAD\_MIN} + I_{R\_MAX}} \tag{2}$$

$$R_{S\_MAX} = \frac{V_{IN\_MIN} - V_{OUT}}{I_{LOAD\_MAX} + I_{R\_MIN}} \tag{3}$$

### 9.2.1.3 Application Curve



Figure 11. Reverse Characteristics And Minimum Operating Current

**Typical Applications (continued)**
**9.2.2 4.1-V ADC Application**

**Figure 12. 4.1-V LM4040-N'S Nominal 4.096 Breakdown Voltage Gives ADC12451 1 MV/LSB**
**9.2.2.1 Design Requirements**

The only design requirement is for an output voltage of 4.096 V.

**9.2.2.2 Detailed Design Procedure**

Using an LM4040-4.1, select an appropriate  $R_S$  to sufficiently power the device. Set the target  $I_R$  for 1 mA. With an input voltage of 5 V, the resistor can be calculated:

$$R = \frac{5\text{ V} - 4.096\text{ V}}{1\text{ mA}} = 904\ \Omega \quad (4)$$

The closest available resistance of 909  $\Omega$  is used here, which in turn yields an  $I_R$  of 994  $\mu$ A.

## Typical Applications (continued)

### 9.2.3 Bounded Amplifier

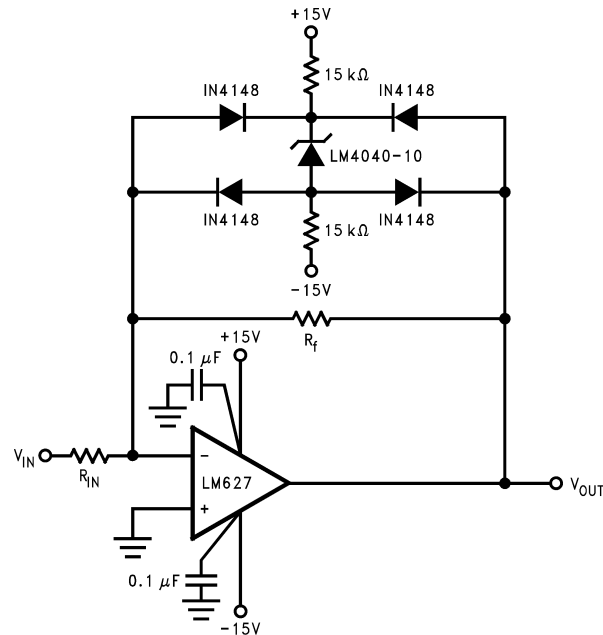

Nominal clamping voltage is  $\pm 11.5$  V (LM4040-N's reverse breakdown voltage +2 diode  $V_F$ ).

**Figure 13. Bounded Amplifier Reduces Saturation-Induced Delays and Can Prevent Succeeding Stage Damage**

#### 9.2.3.1 Design Requirements

Design an amplifier with output clamped at  $\pm 11.5$  V.

#### 9.2.3.2 Detailed Design Procedure

With amplifier rails of  $\pm 15$  V, the output can be bound to  $\pm 11.5$  V with the LM4040-10 and two nominal diode voltage drops of 0.7 V.

$$V_{OUTBound} = 2 \times V_{FWD} + V_Z \quad (5)$$

$$V_{OUTBound} = 1.4 \text{ V} + 10 \text{ V} \quad (6)$$

Select  $R_S = 15 \text{ k}\Omega$  to keep  $I_R$  low. Calculate  $I_R$  to confirm  $R_S$  selection.

$$I_R = (V_{IN} - V_{OUT}) / R, \text{ however in this case, the negative supply must be taken into account.} \quad (7)$$

$$I_R = (V_{IN+} - V_{IN-} - V_{OUT}) / R = (30 \text{ V} - 10 \text{ V}) / (R_{S1} + R_{S2}) = 20 \text{ V} / 30 \text{ k}\Omega = 0.667 \text{ mA} \quad (8)$$

This is an acceptable value for  $I_R$  that will not draw excessive current, but prevents the part from being starved for current.

## Typical Applications (continued)

### 9.2.4 Protecting Op-Amp Input



The bounding voltage is  $\pm 4$  V with the 2.5-V LM4040-N (LM4040-N's reverse breakdown voltage + 3 diode  $V_F$ ).

**Figure 14. Protecting Op Amp Input**

#### 9.2.4.1 Design Requirements

Limit the input voltage to the op-amp to  $\pm 4$  V.

#### 9.2.4.2 Detailed Design Procedure

Similar to [Bounded Amplifier](#), this design uses a LM4040-2.5 and three forward diode voltage drops to create a voltage clamp. The procedure for selecting the  $R_S$  resistors, in this case 5 k $\Omega$ , is the same as [Detailed Design Procedure](#).

$$I_R = (V_{IN+} - V_{IN-} - V_{OUT}) / R = (10 \text{ V} - 2.5 \text{ V}) / (R_{S1} + R_{S2}) = 7.5 \text{ V} / 10 \text{ k}\Omega = 0.750 \text{ mA} \quad (9)$$

## Typical Applications (continued)

### 9.2.5 Precision $\pm 4.096$ -V Reference



Figure 15. Precision  $\pm 4.096$ -V Reference

#### 9.2.5.1 Design Requirements

Use a single voltage reference to create positive and negative reference rails,  $\pm 4.096$  V.

#### 9.2.5.2 Detailed Design Procedure

The procedure for selecting the  $R_S$  resistor is same as detailed in [Detailed Design Procedure](#). The output of the voltage reference is used as the inverting input to the op-amp, with unity gain.

**Typical Applications (continued)**
**9.2.6 Precision Current Sink/Source**

**Figure 16. Precision 1-mA Current Sink**

**Figure 17. Precision 1-mA Current Source**
**9.2.6.1 Design Requirements**

Create precision 1-mA current sink and/or 1-mA current source.

**9.2.6.2 Detailed Design Procedure**

Set R1 such that the current through the shunt reference,  $I_R$ , is greater than  $I_{RMIN}$ .

$I_{OUT} = V_{OUT} / R_2$  where  $V_{OUT}$  is the voltage drop across the shunt reference. In this case,

$$I_{OUT} = 2.5 / R_2$$

## 10 Power Supply Recommendations

While a bypass capacitor is not required on the input voltage line, TI recommends reducing noise on the input which could affect the output. A 0.1- $\mu$ F ceramic capacitor or larger is recommended.

## 11 Layout

### 11.1 Layout Guidelines

Place external components as close to the device as possible. Place  $R_S$  close the cathode, as well as the input bypass capacitor, if used.

### 11.2 Layout Example



**Figure 18. Layout Diagram**

## 12 Device and Documentation Support

### 12.1 Documentation Support

#### 12.1.1 Related Documentation

For related documentation, see the following:

*LM4041-N/LM4041-N-Q1 Precision Micropower Shunt Voltage Reference*, [SNOS641](#)

### 12.2 Related Links

The table below lists quick access links. Categories include technical documents, support and community resources, tools and software, and quick access to sample or buy.

**Table 1. Related Links**

PARTS	PRODUCT FOLDER	SAMPLE & BUY	TECHNICAL DOCUMENTS	TOOLS & SOFTWARE	SUPPORT & COMMUNITY
LM4040-N	<a href="#">Click here</a>	<a href="#">Click here</a>	<a href="#">Click here</a>	<a href="#">Click here</a>	<a href="#">Click here</a>
LM4040-N-Q1	<a href="#">Click here</a>	<a href="#">Click here</a>	<a href="#">Click here</a>	<a href="#">Click here</a>	<a href="#">Click here</a>
LM4040-N-Q1	<a href="#">Click here</a>	<a href="#">Click here</a>	<a href="#">Click here</a>	<a href="#">Click here</a>	<a href="#">Click here</a>

### 12.3 Community Resources

The following links connect to TI community resources. Linked contents are provided "AS IS" by the respective contributors. They do not constitute TI specifications and do not necessarily reflect TI's views; see TI's [Terms of Use](#).

**TI E2E™ Online Community** *TI's Engineer-to-Engineer (E2E) Community*. Created to foster collaboration among engineers. At [e2e.ti.com](http://e2e.ti.com), you can ask questions, share knowledge, explore ideas and help solve problems with fellow engineers.

**Design Support** *TI's Design Support* Quickly find helpful E2E forums along with design support tools and contact information for technical support.

### 12.4 Trademarks

E2E is a trademark of Texas Instruments.  
All other trademarks are the property of their respective owners.

### 12.5 Electrostatic Discharge Caution



These devices have limited built-in ESD protection. The leads should be shorted together or the device placed in conductive foam during storage or handling to prevent electrostatic damage to the MOS gates.

### 12.6 Glossary

[SLYZ022](#) — *TI Glossary*.

This glossary lists and explains terms, acronyms, and definitions.

## 13 Mechanical, Packaging, And Orderable Information

The following pages include mechanical, packaging, and orderable information. This information is the most current data available for the designated devices. This data is subject to change without notice and revision of this document. For browser-based versions of this data sheet, refer to the left-hand navigation.

### 13.1 SOT-23 and SC70 Package Marking Information

Only three fields of marking are possible on the SOT-23's and SC70's small surface. This table gives the meaning of the three fields.

First Field:

**SOT-23 and SC70 Package Marking Information (continued)**

R = Reference

Second Field: Voltage Option

J = 2.048-V Voltage Option

2 = 2.5-V Voltage Option

K = 3-V Voltage Option

4 = 4.096-V Voltage Option

5 = 5-V Voltage Option

8 = 8.192-V Voltage Option

0 = 10-V Voltage Option

Third Field: Initial Reverse Breakdown Voltage or Reference Voltage Tolerance

 A =  $\pm 0.1\%$ 

 B =  $\pm 0.2\%$ 

 C =  $+0.5\%$ 

 D =  $\pm 1.0\%$ 

 E =  $\pm 2.0\%$ 

PART MARKING	FIELD DEFINITION
RJA (SOT-23 only)	Reference, 2.048 V, $\pm 0.1\%$
R2A (SOT-23 only)	Reference, 2.5 V, $\pm 0.1\%$
RKA (SOT-23 only)	Reference, 3 V, $\pm 0.1\%$
R4A (SOT-23 only)	Reference, 4.096 V, $\pm 0.1\%$
R5A (SOT-23 only)	Reference, 5 V, $\pm 0.1\%$
R8A (SOT-23 only)	Reference, 8.192 V, $\pm 0.1\%$
R0A (SOT-23 only)	Reference, 10 V, $\pm 0.1\%$
RJB	Reference, 2.048 V, $\pm 0.2\%$
R2B	Reference, 2.5 V, $\pm 0.2\%$
RKB	Reference, 3 V, $\pm 0.2\%$
R4B	Reference, 4.096 V, $\pm 0.2\%$
R5B	Reference, 5 V, $\pm 0.2\%$
R8B (SOT-23 only)	Reference, 8.192 V, $\pm 0.2\%$
R0B (SOT-23 only)	Reference, 10 V, $\pm 0.2\%$
RJC	Reference, 2.048 V, $\pm 0.5\%$
R2C	Reference, 2.5 V, $\pm 0.5\%$
RKC	Reference, 3 V, $\pm 0.5\%$
R4C	Reference, 4.096 V, $\pm 0.5\%$
R5C	Reference, 5 V, $\pm 0.5\%$
R8C (SOT-23 only)	Reference, 8.192 V, $\pm 0.5\%$
R0C (SOT-23 only)	Reference, 10 V, $\pm 0.5\%$
RJD	Reference, 2.048 V, $\pm 1.0\%$
R2D	Reference, 2.5 V, $\pm 1.0\%$
RKD	Reference, 3 V, $\pm 1.0\%$
R4D	Reference, 4.096 V, $\pm 1.0\%$
R5D	Reference, 5 V, $\pm 1.0\%$
R8D (SOT-23 only)	Reference, 8.192 V, $\pm 1.0\%$
R0D (SOT-23 only)	Reference, 10 V, $\pm 1.0\%$
RJE	Reference, 2.048 V, $\pm 2.0\%$
R2E	Reference, 2.5 V, $\pm 2.0\%$
RKE	Reference, 3 V, $\pm 2.0\%$

**PACKAGING INFORMATION**

Orderable Device	Status (1)	Package Type	Package Drawing	Pins	Package Qty	Eco Plan (2)	Lead/Ball Finish (6)	MSL Peak Temp (3)	Op Temp (°C)	Device Marking (4/5)	Samples
LM4040AIM3-10.0	NRND	SOT-23	DBZ	3	1000	TBD	Call TI	Call TI		R0A	
LM4040AIM3-10.0/NOPB	ACTIVE	SOT-23	DBZ	3	1000	Green (RoHS & no Sb/Br)	CU SN	Level-1-260C-UNLIM	-40 to 85	R0A	<a href="#">Samples</a>
LM4040AIM3-2.0	NRND	SOT-23	DBZ	3	1000	TBD	Call TI	Call TI		RJA	
LM4040AIM3-2.0/NOPB	ACTIVE	SOT-23	DBZ	3	1000	Green (RoHS & no Sb/Br)	CU SN	Level-1-260C-UNLIM		RJA	<a href="#">Samples</a>
LM4040AIM3-2.5	ACTIVE	SOT-23	DBZ	3	1000	TBD	Call TI	Call TI		R2A	<a href="#">Samples</a>
LM4040AIM3-2.5/NOPB	ACTIVE	SOT-23	DBZ	3	1000	Green (RoHS & no Sb/Br)	CU SN	Level-1-260C-UNLIM		R2A	<a href="#">Samples</a>
LM4040AIM3-3.0/NOPB	ACTIVE	SOT-23	DBZ	3	1000	Green (RoHS & no Sb/Br)	CU SN	Level-1-260C-UNLIM		RKA	<a href="#">Samples</a>
LM4040AIM3-4.1	NRND	SOT-23	DBZ	3	1000	TBD	Call TI	Call TI		R4A	
LM4040AIM3-4.1/NOPB	ACTIVE	SOT-23	DBZ	3	1000	Green (RoHS & no Sb/Br)	CU SN	Level-1-260C-UNLIM		R4A	<a href="#">Samples</a>
LM4040AIM3-5.0	NRND	SOT-23	DBZ	3	1000	TBD	Call TI	Call TI		R5A	
LM4040AIM3-5.0/NOPB	ACTIVE	SOT-23	DBZ	3	1000	Green (RoHS & no Sb/Br)	CU SN	Level-1-260C-UNLIM		R5A	<a href="#">Samples</a>
LM4040AIM3X-10/NOPB	ACTIVE	SOT-23	DBZ	3	3000	Green (RoHS & no Sb/Br)	CU SN	Level-1-260C-UNLIM		R0A	<a href="#">Samples</a>
LM4040AIM3X-2.0/NOPB	ACTIVE	SOT-23	DBZ	3	3000	Green (RoHS & no Sb/Br)	CU SN	Level-1-260C-UNLIM		RJA	<a href="#">Samples</a>
LM4040AIM3X-2.5	NRND	SOT-23	DBZ	3	3000	TBD	Call TI	Call TI		R2A	
LM4040AIM3X-2.5/NOPB	ACTIVE	SOT-23	DBZ	3	3000	Green (RoHS & no Sb/Br)	CU SN	Level-1-260C-UNLIM		R2A	<a href="#">Samples</a>
LM4040AIM3X-3.0/NOPB	ACTIVE	SOT-23	DBZ	3	3000	Green (RoHS & no Sb/Br)	CU SN	Level-1-260C-UNLIM		RKA	<a href="#">Samples</a>
LM4040AIM3X-4.1/NOPB	ACTIVE	SOT-23	DBZ	3	3000	Green (RoHS & no Sb/Br)	CU SN	Level-1-260C-UNLIM		R4A	<a href="#">Samples</a>
LM4040AIM3X-5.0	NRND	SOT-23	DBZ	3	3000	TBD	Call TI	Call TI		R5A	
LM4040AIM3X-5.0/NOPB	ACTIVE	SOT-23	DBZ	3	3000	Green (RoHS & no Sb/Br)	CU SN	Level-1-260C-UNLIM		R5A	<a href="#">Samples</a>
LM4040AIZ-10.0/NOPB	ACTIVE	TO-92	LP	3	1800	Green (RoHS & no Sb/Br)	CU SN	N / A for Pkg Type		4040A IZ10	<a href="#">Samples</a>

Orderable Device	Status (1)	Package Type	Package Drawing	Pins	Package Qty	Eco Plan (2)	Lead/Ball Finish (6)	MSL Peak Temp (3)	Op Temp (°C)	Device Marking (4/5)	Samples
LM4040AIZ-2.5/NOPB	ACTIVE	TO-92	LP	3	1800	Green (RoHS & no Sb/Br)	CU SN	N / A for Pkg Type		4040A IZ2.5	<a href="#">Samples</a>
LM4040AIZ-4.1/NOPB	ACTIVE	TO-92	LP	3	1800	Green (RoHS & no Sb/Br)	CU SN	N / A for Pkg Type		4040A IZ4.1	<a href="#">Samples</a>
LM4040AIZ-5.0/NOPB	ACTIVE	TO-92	LP	3	1800	Green (RoHS & no Sb/Br)	CU SN	N / A for Pkg Type		4040A IZ5.0	<a href="#">Samples</a>
LM4040BIM3-10.0	NRND	SOT-23	DBZ	3	1000	TBD	Call TI	Call TI		R0B	
LM4040BIM3-10.0/NOPB	ACTIVE	SOT-23	DBZ	3	1000	Green (RoHS & no Sb/Br)	CU SN	Level-1-260C-UNLIM		R0B	<a href="#">Samples</a>
LM4040BIM3-2.0/NOPB	ACTIVE	SOT-23	DBZ	3	1000	Green (RoHS & no Sb/Br)	CU SN	Level-1-260C-UNLIM		RJB	<a href="#">Samples</a>
LM4040BIM3-2.5	ACTIVE	SOT-23	DBZ	3	1000	TBD	Call TI	Call TI		R2B	<a href="#">Samples</a>
LM4040BIM3-2.5/NOPB	ACTIVE	SOT-23	DBZ	3	1000	Green (RoHS & no Sb/Br)	CU SN	Level-1-260C-UNLIM		R2B	<a href="#">Samples</a>
LM4040BIM3-3.0	NRND	SOT-23	DBZ	3	1000	TBD	Call TI	Call TI		RKB	
LM4040BIM3-3.0/NOPB	ACTIVE	SOT-23	DBZ	3	1000	Green (RoHS & no Sb/Br)	CU SN	Level-1-260C-UNLIM		RKB	<a href="#">Samples</a>
LM4040BIM3-4.1	NRND	SOT-23	DBZ	3	1000	TBD	Call TI	Call TI		R4B	
LM4040BIM3-4.1/NOPB	ACTIVE	SOT-23	DBZ	3	1000	Green (RoHS & no Sb/Br)	CU SN	Level-1-260C-UNLIM		R4B	<a href="#">Samples</a>
LM4040BIM3-5.0	NRND	SOT-23	DBZ	3	1000	TBD	Call TI	Call TI		R5B	
LM4040BIM3-5.0/NOPB	ACTIVE	SOT-23	DBZ	3	1000	Green (RoHS & no Sb/Br)	CU SN	Level-1-260C-UNLIM		R5B	<a href="#">Samples</a>
LM4040BIM3-8.2	NRND	SOT-23	DBZ	3	1000	TBD	Call TI	Call TI		R8B	
LM4040BIM3-8.2/NOPB	ACTIVE	SOT-23	DBZ	3	1000	Green (RoHS & no Sb/Br)	CU SN	Level-1-260C-UNLIM		R8B	<a href="#">Samples</a>
LM4040BIM3X-10/NOPB	ACTIVE	SOT-23	DBZ	3	3000	Green (RoHS & no Sb/Br)	CU SN	Level-1-260C-UNLIM		R0B	<a href="#">Samples</a>
LM4040BIM3X-2.0/NOPB	ACTIVE	SOT-23	DBZ	3	3000	Green (RoHS & no Sb/Br)	CU SN	Level-1-260C-UNLIM		RJB	<a href="#">Samples</a>
LM4040BIM3X-2.5	NRND	SOT-23	DBZ	3	3000	TBD	Call TI	Call TI		R2B	
LM4040BIM3X-2.5/NOPB	ACTIVE	SOT-23	DBZ	3	3000	Green (RoHS & no Sb/Br)	CU SN	Level-1-260C-UNLIM		R2B	<a href="#">Samples</a>
LM4040BIM3X-3.0/NOPB	ACTIVE	SOT-23	DBZ	3	3000	Green (RoHS & no Sb/Br)	CU SN	Level-1-260C-UNLIM		RKB	<a href="#">Samples</a>

Orderable Device	Status (1)	Package Type	Package Drawing	Pins	Package Qty	Eco Plan (2)	Lead/Ball Finish (6)	MSL Peak Temp (3)	Op Temp (°C)	Device Marking (4/5)	Samples
LM4040BIM3X-4.1	NRND	SOT-23	DBZ	3	3000	TBD	Call TI	Call TI		R4B	
LM4040BIM3X-4.1/NOPB	ACTIVE	SOT-23	DBZ	3	3000	Green (RoHS & no Sb/Br)	CU SN	Level-1-260C-UNLIM		R4B	<a href="#">Samples</a>
LM4040BIM3X-5.0/NOPB	ACTIVE	SOT-23	DBZ	3	3000	Green (RoHS & no Sb/Br)	CU SN	Level-1-260C-UNLIM		R5B	<a href="#">Samples</a>
LM4040BIM7-2.0/NOPB	ACTIVE	SC70	DCK	5	1000	Green (RoHS & no Sb/Br)	CU SN	Level-1-260C-UNLIM		RJB	<a href="#">Samples</a>
LM4040BIM7-2.5	NRND	SC70	DCK	5	1000	TBD	Call TI	Call TI		R2B	
LM4040BIM7-2.5/NOPB	ACTIVE	SC70	DCK	5	1000	Green (RoHS & no Sb/Br)	CU SN	Level-1-260C-UNLIM		R2B	<a href="#">Samples</a>
LM4040BIM7-5.0/NOPB	ACTIVE	SC70	DCK	5	1000	Green (RoHS & no Sb/Br)	CU SN	Level-1-260C-UNLIM		R5B	<a href="#">Samples</a>
LM4040BIM7X-2.5/NOPB	ACTIVE	SC70	DCK	5	3000	Green (RoHS & no Sb/Br)	CU SN	Level-1-260C-UNLIM		R2B	<a href="#">Samples</a>
LM4040BIZ-10.0/NOPB	ACTIVE	TO-92	LP	3	1800	Green (RoHS & no Sb/Br)	CU SN	N / A for Pkg Type		4040B IZ10	<a href="#">Samples</a>
LM4040BIZ-2.5/NOPB	ACTIVE	TO-92	LP	3	1800	Green (RoHS & no Sb/Br)	CU SN	N / A for Pkg Type		4040B IZ2.5	<a href="#">Samples</a>
LM4040BIZ-4.1/NOPB	ACTIVE	TO-92	LP	3	1800	Green (RoHS & no Sb/Br)	CU SN	N / A for Pkg Type		4040B IZ4.1	<a href="#">Samples</a>
LM4040BIZ-5.0/NOPB	ACTIVE	TO-92	LP	3	1800	Green (RoHS & no Sb/Br)	CU SN	N / A for Pkg Type		4040B IZ5.0	<a href="#">Samples</a>
LM4040CEM3-2.5	NRND	SOT-23	DBZ	3	1000	TBD	Call TI	Call TI		R2C	
LM4040CEM3-2.5/NOPB	ACTIVE	SOT-23	DBZ	3	1000	Green (RoHS & no Sb/Br)	CU SN	Level-1-260C-UNLIM		R2C	<a href="#">Samples</a>
LM4040CEM3-3.0/NOPB	ACTIVE	SOT-23	DBZ	3	1000	Green (RoHS & no Sb/Br)	CU SN	Level-1-260C-UNLIM		RKC	<a href="#">Samples</a>
LM4040CEM3-5.0	NRND	SOT-23	DBZ	3	1000	TBD	Call TI	Call TI		R5C	
LM4040CEM3-5.0/NOPB	ACTIVE	SOT-23	DBZ	3	1000	Green (RoHS & no Sb/Br)	CU SN	Level-1-260C-UNLIM		R5C	<a href="#">Samples</a>
LM4040CEM3X-3.0/NOPB	ACTIVE	SOT-23	DBZ	3	3000	Green (RoHS & no Sb/Br)	CU SN	Level-1-260C-UNLIM		RKC	<a href="#">Samples</a>
LM4040CEM3X-5.0/NOPB	ACTIVE	SOT-23	DBZ	3	3000	Green (RoHS & no Sb/Br)	CU SN	Level-1-260C-UNLIM		R5C	<a href="#">Samples</a>
LM4040CIM3-10.0	NRND	SOT-23	DBZ	3	1000	TBD	Call TI	Call TI		R0C	

Orderable Device	Status (1)	Package Type	Package Drawing	Pins	Package Qty	Eco Plan (2)	Lead/Ball Finish (6)	MSL Peak Temp (3)	Op Temp (°C)	Device Marking (4/5)	Samples
LM4040CIM3-10.0/NOPB	ACTIVE	SOT-23	DBZ	3	1000	Green (RoHS & no Sb/Br)	CU SN	Level-1-260C-UNLIM		R0C	<a href="#">Samples</a>
LM4040CIM3-2.0	NRND	SOT-23	DBZ	3	1000	TBD	Call TI	Call TI		RJC	
LM4040CIM3-2.0/NOPB	ACTIVE	SOT-23	DBZ	3	1000	Green (RoHS & no Sb/Br)	CU SN	Level-1-260C-UNLIM		RJC	<a href="#">Samples</a>
LM4040CIM3-2.5	NRND	SOT-23	DBZ	3	1000	TBD	Call TI	Call TI		R2C	
LM4040CIM3-2.5/NOPB	ACTIVE	SOT-23	DBZ	3	1000	Green (RoHS & no Sb/Br)	CU SN	Level-1-260C-UNLIM		R2C	<a href="#">Samples</a>
LM4040CIM3-3.0	NRND	SOT-23	DBZ	3	1000	TBD	Call TI	Call TI		RKC	
LM4040CIM3-3.0/NOPB	ACTIVE	SOT-23	DBZ	3	1000	Green (RoHS & no Sb/Br)	CU SN	Level-1-260C-UNLIM		RKC	<a href="#">Samples</a>
LM4040CIM3-4.1	NRND	SOT-23	DBZ	3	1000	TBD	Call TI	Call TI		R4C	
LM4040CIM3-4.1/NOPB	ACTIVE	SOT-23	DBZ	3	1000	Green (RoHS & no Sb/Br)	CU SN	Level-1-260C-UNLIM		R4C	<a href="#">Samples</a>
LM4040CIM3-5.0	NRND	SOT-23	DBZ	3	1000	TBD	Call TI	Call TI		R5C	
LM4040CIM3-5.0/NOPB	ACTIVE	SOT-23	DBZ	3	1000	Green (RoHS & no Sb/Br)	CU SN	Level-1-260C-UNLIM		R5C	<a href="#">Samples</a>
LM4040CIM3-8.2	NRND	SOT-23	DBZ	3	1000	TBD	Call TI	Call TI		R8C	
LM4040CIM3-8.2/NOPB	ACTIVE	SOT-23	DBZ	3	1000	Green (RoHS & no Sb/Br)	CU SN	Level-1-260C-UNLIM		R8C	<a href="#">Samples</a>
LM4040CIM3X-10/NOPB	ACTIVE	SOT-23	DBZ	3	3000	Green (RoHS & no Sb/Br)	CU SN	Level-1-260C-UNLIM		R0C	<a href="#">Samples</a>
LM4040CIM3X-2.0/NOPB	ACTIVE	SOT-23	DBZ	3	3000	Green (RoHS & no Sb/Br)	CU SN	Level-1-260C-UNLIM		RJC	<a href="#">Samples</a>
LM4040CIM3X-2.5	NRND	SOT-23	DBZ	3	3000	TBD	Call TI	Call TI		R2C	
LM4040CIM3X-2.5/NOPB	ACTIVE	SOT-23	DBZ	3	3000	Green (RoHS & no Sb/Br)	CU SN	Level-1-260C-UNLIM		R2C	<a href="#">Samples</a>
LM4040CIM3X-3.0/NOPB	ACTIVE	SOT-23	DBZ	3	3000	Green (RoHS & no Sb/Br)	CU SN	Level-1-260C-UNLIM		RKC	<a href="#">Samples</a>
LM4040CIM3X-4.1/NOPB	ACTIVE	SOT-23	DBZ	3	3000	Green (RoHS & no Sb/Br)	CU SN	Level-1-260C-UNLIM		R4C	<a href="#">Samples</a>
LM4040CIM3X-5.0	NRND	SOT-23	DBZ	3	3000	TBD	Call TI	Call TI		R5C	
LM4040CIM3X-5.0/NOPB	ACTIVE	SOT-23	DBZ	3	3000	Green (RoHS & no Sb/Br)	CU SN	Level-1-260C-UNLIM		R5C	<a href="#">Samples</a>

Orderable Device	Status (1)	Package Type	Package Drawing	Pins	Package Qty	Eco Plan (2)	Lead/Ball Finish (6)	MSL Peak Temp (3)	Op Temp (°C)	Device Marking (4/5)	Samples
LM4040CIM7-2.0/NOPB	ACTIVE	SC70	DCK	5	1000	Green (RoHS & no Sb/Br)	CU SN	Level-1-260C-UNLIM		RJC	<a href="#">Samples</a>
LM4040CIM7-2.5/NOPB	ACTIVE	SC70	DCK	5	1000	Green (RoHS & no Sb/Br)	CU SN	Level-1-260C-UNLIM		R2C	<a href="#">Samples</a>
LM4040CIM7X-2.5/NOPB	ACTIVE	SC70	DCK	5	3000	Green (RoHS & no Sb/Br)	CU SN	Level-1-260C-UNLIM		R2C	<a href="#">Samples</a>
LM4040CIZ-10.0/NOPB	ACTIVE	TO-92	LP	3	1800	Green (RoHS & no Sb/Br)	CU SN	N / A for Pkg Type		4040C IZ10	<a href="#">Samples</a>
LM4040CIZ-2.5/LFT8	ACTIVE	TO-92	LP	3	2000	Green (RoHS & no Sb/Br)	CU SN	N / A for Pkg Type		4040C IZ2.5	<a href="#">Samples</a>
LM4040CIZ-2.5/NOPB	ACTIVE	TO-92	LP	3	1800	Green (RoHS & no Sb/Br)	CU SN	N / A for Pkg Type		4040C IZ2.5	<a href="#">Samples</a>
LM4040CIZ-4.1/NOPB	ACTIVE	TO-92	LP	3	1800	Green (RoHS & no Sb/Br)	CU SN	N / A for Pkg Type		4040C IZ4.1	<a href="#">Samples</a>
LM4040CIZ-5.0/NOPB	ACTIVE	TO-92	LP	3	1800	Green (RoHS & no Sb/Br)	CU SN	N / A for Pkg Type		4040C IZ5.0	<a href="#">Samples</a>
LM4040DEM3-2.0	NRND	SOT-23	DBZ	3	1000	TBD	Call TI	Call TI		RJD	
LM4040DEM3-2.0/NOPB	ACTIVE	SOT-23	DBZ	3	1000	Green (RoHS & no Sb/Br)	CU SN	Level-1-260C-UNLIM		RJD	<a href="#">Samples</a>
LM4040DEM3-2.5/NOPB	ACTIVE	SOT-23	DBZ	3	1000	Green (RoHS & no Sb/Br)	CU SN	Level-1-260C-UNLIM		R2D	<a href="#">Samples</a>
LM4040DEM3-3.0/NOPB	ACTIVE	SOT-23	DBZ	3	1000	Green (RoHS & no Sb/Br)	CU SN	Level-1-260C-UNLIM		RKD	<a href="#">Samples</a>
LM4040DEM3-5.0	NRND	SOT-23	DBZ	3	1000	TBD	Call TI	Call TI		R5D	
LM4040DEM3-5.0/NOPB	ACTIVE	SOT-23	DBZ	3	1000	Green (RoHS & no Sb/Br)	CU SN	Level-1-260C-UNLIM		R5D	<a href="#">Samples</a>
LM4040DEM3X-2.5/NOPB	ACTIVE	SOT-23	DBZ	3	3000	Green (RoHS & no Sb/Br)	CU SN	Level-1-260C-UNLIM		R2D	<a href="#">Samples</a>
LM4040DEM3X-5.0/NOPB	ACTIVE	SOT-23	DBZ	3	3000	Green (RoHS & no Sb/Br)	CU SN	Level-1-260C-UNLIM		R5D	<a href="#">Samples</a>
LM4040DIM3-10.0	NRND	SOT-23	DBZ	3	1000	TBD	Call TI	Call TI		R0D	
LM4040DIM3-10.0/NOPB	ACTIVE	SOT-23	DBZ	3	1000	Green (RoHS & no Sb/Br)	CU SN	Level-1-260C-UNLIM		R0D	<a href="#">Samples</a>
LM4040DIM3-2.0/NOPB	ACTIVE	SOT-23	DBZ	3	1000	Green (RoHS & no Sb/Br)	CU SN	Level-1-260C-UNLIM		RJD	<a href="#">Samples</a>
LM4040DIM3-2.5	NRND	SOT-23	DBZ	3	1000	TBD	Call TI	Call TI		R2D	

Orderable Device	Status (1)	Package Type	Package Drawing	Pins	Package Qty	Eco Plan (2)	Lead/Ball Finish (6)	MSL Peak Temp (3)	Op Temp (°C)	Device Marking (4/5)	Samples
LM4040DIM3-2.5/NOPB	ACTIVE	SOT-23	DBZ	3	1000	Green (RoHS & no Sb/Br)	CU SN	Level-1-260C-UNLIM		R2D	<a href="#">Samples</a>
LM4040DIM3-3.0/NOPB	ACTIVE	SOT-23	DBZ	3	1000	Green (RoHS & no Sb/Br)	CU SN	Level-1-260C-UNLIM		RKD	<a href="#">Samples</a>
LM4040DIM3-4.1	NRND	SOT-23	DBZ	3	1000	TBD	Call TI	Call TI		R4D	
LM4040DIM3-4.1/NOPB	ACTIVE	SOT-23	DBZ	3	1000	Green (RoHS & no Sb/Br)	CU SN	Level-1-260C-UNLIM		R4D	<a href="#">Samples</a>
LM4040DIM3-5.0	NRND	SOT-23	DBZ	3	1000	TBD	Call TI	Call TI		R5D	
LM4040DIM3-5.0/NOPB	ACTIVE	SOT-23	DBZ	3	1000	Green (RoHS & no Sb/Br)	CU SN	Level-1-260C-UNLIM		R5D	<a href="#">Samples</a>
LM4040DIM3-8.2/NOPB	ACTIVE	SOT-23	DBZ	3	1000	Green (RoHS & no Sb/Br)	CU SN	Level-1-260C-UNLIM		R8D	<a href="#">Samples</a>
LM4040DIM3X-10/NOPB	ACTIVE	SOT-23	DBZ	3	3000	Green (RoHS & no Sb/Br)	CU SN	Level-1-260C-UNLIM		R0D	<a href="#">Samples</a>
LM4040DIM3X-2.0/NOPB	ACTIVE	SOT-23	DBZ	3	3000	Green (RoHS & no Sb/Br)	CU SN	Level-1-260C-UNLIM		RJD	<a href="#">Samples</a>
LM4040DIM3X-2.5	NRND	SOT-23	DBZ	3	3000	TBD	Call TI	Call TI		R2D	
LM4040DIM3X-2.5/NOPB	ACTIVE	SOT-23	DBZ	3	3000	Green (RoHS & no Sb/Br)	CU SN	Level-1-260C-UNLIM		R2D	<a href="#">Samples</a>
LM4040DIM3X-3.0/NOPB	ACTIVE	SOT-23	DBZ	3	3000	Green (RoHS & no Sb/Br)	CU SN	Level-1-260C-UNLIM		RKD	<a href="#">Samples</a>
LM4040DIM3X-4.1/NOPB	ACTIVE	SOT-23	DBZ	3	3000	Green (RoHS & no Sb/Br)	CU SN	Level-1-260C-UNLIM		R4D	<a href="#">Samples</a>
LM4040DIM3X-5.0	NRND	SOT-23	DBZ	3	3000	TBD	Call TI	Call TI		R5D	
LM4040DIM3X-5.0/NOPB	ACTIVE	SOT-23	DBZ	3	3000	Green (RoHS & no Sb/Br)	CU SN	Level-1-260C-UNLIM		R5D	<a href="#">Samples</a>
LM4040DIM7-2.0/NOPB	ACTIVE	SC70	DCK	5	1000	Green (RoHS & no Sb/Br)	CU SN	Level-1-260C-UNLIM		RJD	<a href="#">Samples</a>
LM4040DIM7-2.5/NOPB	ACTIVE	SC70	DCK	5	1000	Green (RoHS & no Sb/Br)	CU SN	Level-1-260C-UNLIM		R2D	<a href="#">Samples</a>
LM4040DIM7-5.0	NRND	SC70	DCK	5	1000	TBD	Call TI	Call TI		R5D	
LM4040DIM7-5.0/NOPB	ACTIVE	SC70	DCK	5	1000	Green (RoHS & no Sb/Br)	CU SN	Level-1-260C-UNLIM		R5D	<a href="#">Samples</a>
LM4040DIZ-10.0/NOPB	ACTIVE	TO-92	LP	3	1800	Green (RoHS & no Sb/Br)	CU SN	N / A for Pkg Type		4040D IZ10	<a href="#">Samples</a>

Orderable Device	Status (1)	Package Type	Package Drawing	Pins	Package Qty	Eco Plan (2)	Lead/Ball Finish (6)	MSL Peak Temp (3)	Op Temp (°C)	Device Marking (4/5)	Samples
LM4040DIZ-2.5/NOPB	ACTIVE	TO-92	LP	3	1800	Green (RoHS & no Sb/Br)	CU SN	N / A for Pkg Type		4040D IZ2.5	<a href="#">Samples</a>
LM4040DIZ-4.1/NOPB	ACTIVE	TO-92	LP	3	1800	Green (RoHS & no Sb/Br)	CU SN	N / A for Pkg Type		4040D IZ4.1	<a href="#">Samples</a>
LM4040DIZ-5.0/LFT1	ACTIVE	TO-92	LP	3	2000	Green (RoHS & no Sb/Br)	CU SN	N / A for Pkg Type		4040D IZ5.0	<a href="#">Samples</a>
LM4040DIZ-5.0/NOPB	ACTIVE	TO-92	LP	3	1800	Green (RoHS & no Sb/Br)	CU SN	N / A for Pkg Type		4040D IZ5.0	<a href="#">Samples</a>
LM4040EEM3-2.5/NOPB	ACTIVE	SOT-23	DBZ	3	1000	Green (RoHS & no Sb/Br)	CU SN	Level-1-260C-UNLIM		R2E	<a href="#">Samples</a>
LM4040EIM3-2.5	NRND	SOT-23	DBZ	3	1000	TBD	Call TI	Call TI		R2E	
LM4040EIM3-2.5/NOPB	ACTIVE	SOT-23	DBZ	3	1000	Green (RoHS & no Sb/Br)	CU SN	Level-1-260C-UNLIM		R2E	<a href="#">Samples</a>
LM4040EIM3-3.0/NOPB	ACTIVE	SOT-23	DBZ	3	1000	Green (RoHS & no Sb/Br)	CU SN	Level-1-260C-UNLIM		RKE	<a href="#">Samples</a>
LM4040EIM3X-2.5	NRND	SOT-23	DBZ	3	3000	TBD	Call TI	Call TI		R2E	
LM4040EIM3X-2.5/NOPB	ACTIVE	SOT-23	DBZ	3	3000	Green (RoHS & no Sb/Br)	CU SN	Level-1-260C-UNLIM		R2E	<a href="#">Samples</a>
LM4040EIM3X-3.0/NOPB	ACTIVE	SOT-23	DBZ	3	3000	Green (RoHS & no Sb/Br)	CU SN	Level-1-260C-UNLIM		RKE	<a href="#">Samples</a>
LM4040EIM7-2.0/NOPB	ACTIVE	SC70	DCK	5	1000	Green (RoHS & no Sb/Br)	CU SN	Level-1-260C-UNLIM		RJE	<a href="#">Samples</a>
LM4040QAIM3-2.5/NOPB	ACTIVE	SOT-23	DBZ	3	1000	Green (RoHS & no Sb/Br)	CU SN	Level-1-260C-UNLIM		R6A	<a href="#">Samples</a>
LM4040QAIM3X2.5/NOPB	ACTIVE	SOT-23	DBZ	3	3000	Green (RoHS & no Sb/Br)	CU SN	Level-1-260C-UNLIM		R6A	<a href="#">Samples</a>
LM4040QBIM3-2.5/NOPB	ACTIVE	SOT-23	DBZ	3	1000	Green (RoHS & no Sb/Br)	CU SN	Level-1-260C-UNLIM		R6B	<a href="#">Samples</a>
LM4040QBIM3X2.5/NOPB	ACTIVE	SOT-23	DBZ	3	3000	Green (RoHS & no Sb/Br)	CU SN	Level-1-260C-UNLIM		R6B	<a href="#">Samples</a>
LM4040QCEM3-2.5/NOPB	ACTIVE	SOT-23	DBZ	3	1000	Green (RoHS & no Sb/Br)	CU SN	Level-1-260C-UNLIM		R2C	<a href="#">Samples</a>
LM4040QCEM3-3.0/NOPB	ACTIVE	SOT-23	DBZ	3	1000	Green (RoHS & no Sb/Br)	CU SN	Level-1-260C-UNLIM	-40 to 125	R3C	<a href="#">Samples</a>
LM4040QCIM3-2.5/NOPB	ACTIVE	SOT-23	DBZ	3	1000	Green (RoHS & no Sb/Br)	CU SN	Level-1-260C-UNLIM		R6C	<a href="#">Samples</a>

Orderable Device	Status (1)	Package Type	Package Drawing	Pins	Package Qty	Eco Plan (2)	Lead/Ball Finish (6)	MSL Peak Temp (3)	Op Temp (°C)	Device Marking (4/5)	Samples
LM4040QCIM3X2.5/NOPB	ACTIVE	SOT-23	DBZ	3	3000	Green (RoHS & no Sb/Br)	CU SN	Level-1-260C-UNLIM		R6C	<a href="#">Samples</a>
LM4040QDEM3-2.5/NOPB	ACTIVE	SOT-23	DBZ	3	1000	Green (RoHS & no Sb/Br)	CU SN	Level-1-260C-UNLIM		R2D	<a href="#">Samples</a>
LM4040QDEM3-3.0/NOPB	ACTIVE	SOT-23	DBZ	3	1000	Green (RoHS & no Sb/Br)	CU SN	Level-1-260C-UNLIM	-40 to 125	R3D	<a href="#">Samples</a>
LM4040QDIM3-2.5/NOPB	ACTIVE	SOT-23	DBZ	3	1000	Green (RoHS & no Sb/Br)	CU SN	Level-1-260C-UNLIM		R6D	<a href="#">Samples</a>
LM4040QDIM3X2.5/NOPB	ACTIVE	SOT-23	DBZ	3	3000	Green (RoHS & no Sb/Br)	CU SN	Level-1-260C-UNLIM		R6D	<a href="#">Samples</a>
LM4040QEEM3-2.5/NOPB	ACTIVE	SOT-23	DBZ	3	1000	Green (RoHS & no Sb/Br)	CU SN	Level-1-260C-UNLIM		R2E	<a href="#">Samples</a>
LM4040QEEM3-3.0/NOPB	ACTIVE	SOT-23	DBZ	3	1000	Green (RoHS & no Sb/Br)	CU SN	Level-1-260C-UNLIM	-40 to 125	R3E	<a href="#">Samples</a>
LM4040QEIM3-2.5/NOPB	ACTIVE	SOT-23	DBZ	3	1000	Green (RoHS & no Sb/Br)	CU SN	Level-1-260C-UNLIM		R6E	<a href="#">Samples</a>
LM4040QEIM3X2.5/NOPB	ACTIVE	SOT-23	DBZ	3	3000	Green (RoHS & no Sb/Br)	CU SN	Level-1-260C-UNLIM		R6E	<a href="#">Samples</a>

(1) The marketing status values are defined as follows:

**ACTIVE:** Product device recommended for new designs.

**LIFEBUY:** TI has announced that the device will be discontinued, and a lifetime-buy period is in effect.

**NRND:** Not recommended for new designs. Device is in production to support existing customers, but TI does not recommend using this part in a new design.

**PREVIEW:** Device has been announced but is not in production. Samples may or may not be available.

**OBSELETE:** TI has discontinued the production of the device.

(2) **RoHS:** TI defines "RoHS" to mean semiconductor products that are compliant with the current EU RoHS requirements for all 10 RoHS substances, including the requirement that RoHS substance do not exceed 0.1% by weight in homogeneous materials. Where designed to be soldered at high temperatures, "RoHS" products are suitable for use in specified lead-free processes. TI may reference these types of products as "Pb-Free".

**RoHS Exempt:** TI defines "RoHS Exempt" to mean products that contain lead but are compliant with EU RoHS pursuant to a specific EU RoHS exemption.

**Green:** TI defines "Green" to mean the content of Chlorine (Cl) and Bromine (Br) based flame retardants meet JS709B low halogen requirements of <=1000ppm threshold. Antimony trioxide based flame retardants must also meet the <=1000ppm threshold requirement.

(3) MSL, Peak Temp. - The Moisture Sensitivity Level rating according to the JEDEC industry standard classifications, and peak solder temperature.

(4) There may be additional marking, which relates to the logo, the lot trace code information, or the environmental category on the device.

<sup>(5)</sup> Multiple Device Markings will be inside parentheses. Only one Device Marking contained in parentheses and separated by a "-" will appear on a device. If a line is indented then it is a continuation of the previous line and the two combined represent the entire Device Marking for that device.

<sup>(6)</sup> Lead/Ball Finish - Orderable Devices may have multiple material finish options. Finish options are separated by a vertical ruled line. Lead/Ball Finish values may wrap to two lines if the finish value exceeds the maximum column width.

**Important Information and Disclaimer:**The information provided on this page represents TI's knowledge and belief as of the date that it is provided. TI bases its knowledge and belief on information provided by third parties, and makes no representation or warranty as to the accuracy of such information. Efforts are underway to better integrate information from third parties. TI has taken and continues to take reasonable steps to provide representative and accurate information but may not have conducted destructive testing or chemical analysis on incoming materials and chemicals. TI and TI suppliers consider certain information to be proprietary, and thus CAS numbers and other limited information may not be available for release.

In no event shall TI's liability arising out of such information exceed the total purchase price of the TI part(s) at issue in this document sold by TI to Customer on an annual basis.

**OTHER QUALIFIED VERSIONS OF LM4040-N, LM4040-N-Q1 :**

- Catalog: [LM4040-N](#)
  
- Automotive: [LM4040-N-Q1](#)

NOTE: Qualified Version Definitions:

- Catalog - TI's standard catalog product
  
- Automotive - Q100 devices qualified for high-reliability automotive applications targeting zero defects

**TAPE AND REEL INFORMATION**

**QUADRANT ASSIGNMENTS FOR PIN 1 ORIENTATION IN TAPE**

\*All dimensions are nominal

Device	Package Type	Package Drawing	Pins	SPQ	Reel Diameter (mm)	Reel Width W1 (mm)	A0 (mm)	B0 (mm)	K0 (mm)	P1 (mm)	W (mm)	Pin1 Quadrant
LM4040AIM3-10.0	SOT-23	DBZ	3	1000	178.0	8.4	3.3	2.9	1.22	4.0	8.0	Q3
LM4040AIM3-10.0/NOPB	SOT-23	DBZ	3	1000	178.0	8.4	3.3	2.9	1.22	4.0	8.0	Q3
LM4040AIM3-2.0	SOT-23	DBZ	3	1000	178.0	8.4	3.3	2.9	1.22	4.0	8.0	Q3
LM4040AIM3-2.0/NOPB	SOT-23	DBZ	3	1000	178.0	8.4	3.3	2.9	1.22	4.0	8.0	Q3
LM4040AIM3-2.5	SOT-23	DBZ	3	1000	178.0	8.4	3.3	2.9	1.22	4.0	8.0	Q3
LM4040AIM3-2.5/NOPB	SOT-23	DBZ	3	1000	178.0	8.4	3.3	2.9	1.22	4.0	8.0	Q3
LM4040AIM3-3.0/NOPB	SOT-23	DBZ	3	1000	178.0	8.4	3.3	2.9	1.22	4.0	8.0	Q3
LM4040AIM3-4.1	SOT-23	DBZ	3	1000	178.0	8.4	3.3	2.9	1.22	4.0	8.0	Q3
LM4040AIM3-4.1/NOPB	SOT-23	DBZ	3	1000	178.0	8.4	3.3	2.9	1.22	4.0	8.0	Q3
LM4040AIM3-5.0	SOT-23	DBZ	3	1000	178.0	8.4	3.3	2.9	1.22	4.0	8.0	Q3
LM4040AIM3-5.0/NOPB	SOT-23	DBZ	3	1000	178.0	8.4	3.3	2.9	1.22	4.0	8.0	Q3
LM4040AIM3X-10/NOPB	SOT-23	DBZ	3	3000	178.0	8.4	3.3	2.9	1.22	4.0	8.0	Q3
LM4040AIM3X-2.0/NOPB	SOT-23	DBZ	3	3000	178.0	8.4	3.3	2.9	1.22	4.0	8.0	Q3
LM4040AIM3X-2.5	SOT-23	DBZ	3	3000	178.0	8.4	3.3	2.9	1.22	4.0	8.0	Q3
LM4040AIM3X-2.5/NOPB	SOT-23	DBZ	3	3000	178.0	8.4	3.3	2.9	1.22	4.0	8.0	Q3
LM4040AIM3X-3.0/NOPB	SOT-23	DBZ	3	3000	178.0	8.4	3.3	2.9	1.22	4.0	8.0	Q3
LM4040AIM3X-4.1/NOPB	SOT-23	DBZ	3	3000	178.0	8.4	3.3	2.9	1.22	4.0	8.0	Q3
LM4040AIM3X-5.0	SOT-23	DBZ	3	3000	178.0	8.4	3.3	2.9	1.22	4.0	8.0	Q3

Device	Package Type	Package Drawing	Pins	SPQ	Reel Diameter (mm)	Reel Width W1 (mm)	A0 (mm)	B0 (mm)	K0 (mm)	P1 (mm)	W (mm)	Pin1 Quadrant
LM4040AIM3X-5.0/NOPB	SOT-23	DBZ	3	3000	178.0	8.4	3.3	2.9	1.22	4.0	8.0	Q3
LM4040BIM3-10.0	SOT-23	DBZ	3	1000	178.0	8.4	3.3	2.9	1.22	4.0	8.0	Q3
LM4040BIM3-10.0/NOPB	SOT-23	DBZ	3	1000	178.0	8.4	3.3	2.9	1.22	4.0	8.0	Q3
LM4040BIM3-2.0/NOPB	SOT-23	DBZ	3	1000	178.0	8.4	3.3	2.9	1.22	4.0	8.0	Q3
LM4040BIM3-2.5	SOT-23	DBZ	3	1000	178.0	8.4	3.3	2.9	1.22	4.0	8.0	Q3
LM4040BIM3-2.5/NOPB	SOT-23	DBZ	3	1000	178.0	8.4	3.3	2.9	1.22	4.0	8.0	Q3
LM4040BIM3-3.0	SOT-23	DBZ	3	1000	178.0	8.4	3.3	2.9	1.22	4.0	8.0	Q3
LM4040BIM3-3.0/NOPB	SOT-23	DBZ	3	1000	178.0	8.4	3.3	2.9	1.22	4.0	8.0	Q3
LM4040BIM3-4.1	SOT-23	DBZ	3	1000	178.0	8.4	3.3	2.9	1.22	4.0	8.0	Q3
LM4040BIM3-4.1/NOPB	SOT-23	DBZ	3	1000	178.0	8.4	3.3	2.9	1.22	4.0	8.0	Q3
LM4040BIM3-5.0	SOT-23	DBZ	3	1000	178.0	8.4	3.3	2.9	1.22	4.0	8.0	Q3
LM4040BIM3-5.0/NOPB	SOT-23	DBZ	3	1000	178.0	8.4	3.3	2.9	1.22	4.0	8.0	Q3
LM4040BIM3-8.2	SOT-23	DBZ	3	1000	178.0	8.4	3.3	2.9	1.22	4.0	8.0	Q3
LM4040BIM3-8.2/NOPB	SOT-23	DBZ	3	1000	178.0	8.4	3.3	2.9	1.22	4.0	8.0	Q3
LM4040BIM3X-10/NOPB	SOT-23	DBZ	3	3000	178.0	8.4	3.3	2.9	1.22	4.0	8.0	Q3
LM4040BIM3X-2.0/NOPB	SOT-23	DBZ	3	3000	178.0	8.4	3.3	2.9	1.22	4.0	8.0	Q3
LM4040BIM3X-2.5	SOT-23	DBZ	3	3000	178.0	8.4	3.3	2.9	1.22	4.0	8.0	Q3
LM4040BIM3X-2.5/NOPB	SOT-23	DBZ	3	3000	178.0	8.4	3.3	2.9	1.22	4.0	8.0	Q3
LM4040BIM3X-3.0/NOPB	SOT-23	DBZ	3	3000	178.0	8.4	3.3	2.9	1.22	4.0	8.0	Q3
LM4040BIM3X-4.1	SOT-23	DBZ	3	3000	178.0	8.4	3.3	2.9	1.22	4.0	8.0	Q3
LM4040BIM3X-4.1/NOPB	SOT-23	DBZ	3	3000	178.0	8.4	3.3	2.9	1.22	4.0	8.0	Q3
LM4040BIM3X-5.0/NOPB	SOT-23	DBZ	3	3000	178.0	8.4	3.3	2.9	1.22	4.0	8.0	Q3
LM4040BIM7-2.0/NOPB	SC70	DCK	5	1000	178.0	8.4	2.25	2.45	1.2	4.0	8.0	Q3
LM4040BIM7-2.5	SC70	DCK	5	1000	178.0	8.4	2.25	2.45	1.2	4.0	8.0	Q3
LM4040BIM7-2.5/NOPB	SC70	DCK	5	1000	178.0	8.4	2.25	2.45	1.2	4.0	8.0	Q3
LM4040BIM7-5.0/NOPB	SC70	DCK	5	1000	178.0	8.4	2.25	2.45	1.2	4.0	8.0	Q3
LM4040BIM7X-2.5/NOPB	SC70	DCK	5	3000	178.0	8.4	2.25	2.45	1.2	4.0	8.0	Q3
LM4040CEM3-2.5	SOT-23	DBZ	3	1000	178.0	8.4	3.3	2.9	1.22	4.0	8.0	Q3
LM4040CEM3-2.5/NOPB	SOT-23	DBZ	3	1000	178.0	8.4	3.3	2.9	1.22	4.0	8.0	Q3
LM4040CEM3-3.0/NOPB	SOT-23	DBZ	3	1000	178.0	8.4	3.3	2.9	1.22	4.0	8.0	Q3
LM4040CEM3-5.0	SOT-23	DBZ	3	1000	178.0	8.4	3.3	2.9	1.22	4.0	8.0	Q3
LM4040CEM3-5.0/NOPB	SOT-23	DBZ	3	1000	178.0	8.4	3.3	2.9	1.22	4.0	8.0	Q3
LM4040CEM3X-3.0/NOPB	SOT-23	DBZ	3	3000	178.0	8.4	3.3	2.9	1.22	4.0	8.0	Q3
LM4040CEM3X-5.0/NOPB	SOT-23	DBZ	3	3000	178.0	8.4	3.3	2.9	1.22	4.0	8.0	Q3
LM4040CIM3-10.0	SOT-23	DBZ	3	1000	178.0	8.4	3.3	2.9	1.22	4.0	8.0	Q3
LM4040CIM3-10.0/NOPB	SOT-23	DBZ	3	1000	178.0	8.4	3.3	2.9	1.22	4.0	8.0	Q3
LM4040CIM3-2.0	SOT-23	DBZ	3	1000	178.0	8.4	3.3	2.9	1.22	4.0	8.0	Q3
LM4040CIM3-2.0/NOPB	SOT-23	DBZ	3	1000	178.0	8.4	3.3	2.9	1.22	4.0	8.0	Q3
LM4040CIM3-2.5	SOT-23	DBZ	3	1000	178.0	8.4	3.3	2.9	1.22	4.0	8.0	Q3
LM4040CIM3-2.5/NOPB	SOT-23	DBZ	3	1000	178.0	8.4	3.3	2.9	1.22	4.0	8.0	Q3
LM4040CIM3-3.0	SOT-23	DBZ	3	1000	178.0	8.4	3.3	2.9	1.22	4.0	8.0	Q3
LM4040CIM3-3.0/NOPB	SOT-23	DBZ	3	1000	178.0	8.4	3.3	2.9	1.22	4.0	8.0	Q3
LM4040CIM3-4.1	SOT-23	DBZ	3	1000	178.0	8.4	3.3	2.9	1.22	4.0	8.0	Q3

Device	Package Type	Package Drawing	Pins	SPQ	Reel Diameter (mm)	Reel Width W1 (mm)	A0 (mm)	B0 (mm)	K0 (mm)	P1 (mm)	W (mm)	Pin1 Quadrant
LM4040CIM3-4.1/NOPB	SOT-23	DBZ	3	1000	178.0	8.4	3.3	2.9	1.22	4.0	8.0	Q3
LM4040CIM3-5.0	SOT-23	DBZ	3	1000	178.0	8.4	3.3	2.9	1.22	4.0	8.0	Q3
LM4040CIM3-5.0/NOPB	SOT-23	DBZ	3	1000	178.0	8.4	3.3	2.9	1.22	4.0	8.0	Q3
LM4040CIM3-8.2	SOT-23	DBZ	3	1000	178.0	8.4	3.3	2.9	1.22	4.0	8.0	Q3
LM4040CIM3-8.2/NOPB	SOT-23	DBZ	3	1000	178.0	8.4	3.3	2.9	1.22	4.0	8.0	Q3
LM4040CIM3X-10/NOPB	SOT-23	DBZ	3	3000	178.0	8.4	3.3	2.9	1.22	4.0	8.0	Q3
LM4040CIM3X-2.0/NOPB	SOT-23	DBZ	3	3000	178.0	8.4	3.3	2.9	1.22	4.0	8.0	Q3
LM4040CIM3X-2.5	SOT-23	DBZ	3	3000	178.0	8.4	3.3	2.9	1.22	4.0	8.0	Q3
LM4040CIM3X-2.5/NOPB	SOT-23	DBZ	3	3000	178.0	8.4	3.3	2.9	1.22	4.0	8.0	Q3
LM4040CIM3X-3.0/NOPB	SOT-23	DBZ	3	3000	178.0	8.4	3.3	2.9	1.22	4.0	8.0	Q3
LM4040CIM3X-4.1/NOPB	SOT-23	DBZ	3	3000	178.0	8.4	3.3	2.9	1.22	4.0	8.0	Q3
LM4040CIM3X-5.0	SOT-23	DBZ	3	3000	178.0	8.4	3.3	2.9	1.22	4.0	8.0	Q3
LM4040CIM3X-5.0/NOPB	SOT-23	DBZ	3	3000	178.0	8.4	3.3	2.9	1.22	4.0	8.0	Q3
LM4040CIM7-2.0/NOPB	SC70	DCK	5	1000	178.0	8.4	2.25	2.45	1.2	4.0	8.0	Q3
LM4040CIM7-2.5/NOPB	SC70	DCK	5	1000	178.0	8.4	2.25	2.45	1.2	4.0	8.0	Q3
LM4040CIM7X-2.5/NOPB	SC70	DCK	5	3000	178.0	8.4	2.25	2.45	1.2	4.0	8.0	Q3
LM4040DEM3-2.0	SOT-23	DBZ	3	1000	178.0	8.4	3.3	2.9	1.22	4.0	8.0	Q3
LM4040DEM3-2.0/NOPB	SOT-23	DBZ	3	1000	178.0	8.4	3.3	2.9	1.22	4.0	8.0	Q3
LM4040DEM3-2.5/NOPB	SOT-23	DBZ	3	1000	178.0	8.4	3.3	2.9	1.22	4.0	8.0	Q3
LM4040DEM3-3.0/NOPB	SOT-23	DBZ	3	1000	178.0	8.4	3.3	2.9	1.22	4.0	8.0	Q3
LM4040DEM3-5.0	SOT-23	DBZ	3	1000	178.0	8.4	3.3	2.9	1.22	4.0	8.0	Q3
LM4040DEM3-5.0/NOPB	SOT-23	DBZ	3	1000	178.0	8.4	3.3	2.9	1.22	4.0	8.0	Q3
LM4040DEM3X-2.5/NOPB	SOT-23	DBZ	3	3000	178.0	8.4	3.3	2.9	1.22	4.0	8.0	Q3
LM4040DEM3X-5.0/NOPB	SOT-23	DBZ	3	3000	178.0	8.4	3.3	2.9	1.22	4.0	8.0	Q3
LM4040DIM3-10.0	SOT-23	DBZ	3	1000	178.0	8.4	3.3	2.9	1.22	4.0	8.0	Q3
LM4040DIM3-10.0/NOPB	SOT-23	DBZ	3	1000	178.0	8.4	3.3	2.9	1.22	4.0	8.0	Q3
LM4040DIM3-2.0/NOPB	SOT-23	DBZ	3	1000	178.0	8.4	3.3	2.9	1.22	4.0	8.0	Q3
LM4040DIM3-2.5	SOT-23	DBZ	3	1000	178.0	8.4	3.3	2.9	1.22	4.0	8.0	Q3
LM4040DIM3-2.5/NOPB	SOT-23	DBZ	3	1000	178.0	8.4	3.3	2.9	1.22	4.0	8.0	Q3
LM4040DIM3-3.0/NOPB	SOT-23	DBZ	3	1000	178.0	8.4	3.3	2.9	1.22	4.0	8.0	Q3
LM4040DIM3-4.1	SOT-23	DBZ	3	1000	178.0	8.4	3.3	2.9	1.22	4.0	8.0	Q3
LM4040DIM3-4.1/NOPB	SOT-23	DBZ	3	1000	178.0	8.4	3.3	2.9	1.22	4.0	8.0	Q3
LM4040DIM3-5.0	SOT-23	DBZ	3	1000	178.0	8.4	3.3	2.9	1.22	4.0	8.0	Q3
LM4040DIM3-5.0/NOPB	SOT-23	DBZ	3	1000	178.0	8.4	3.3	2.9	1.22	4.0	8.0	Q3
LM4040DIM3-8.2/NOPB	SOT-23	DBZ	3	1000	178.0	8.4	3.3	2.9	1.22	4.0	8.0	Q3
LM4040DIM3X-10/NOPB	SOT-23	DBZ	3	3000	178.0	8.4	3.3	2.9	1.22	4.0	8.0	Q3
LM4040DIM3X-2.0/NOPB	SOT-23	DBZ	3	3000	178.0	8.4	3.3	2.9	1.22	4.0	8.0	Q3
LM4040DIM3X-2.5	SOT-23	DBZ	3	3000	178.0	8.4	3.3	2.9	1.22	4.0	8.0	Q3
LM4040DIM3X-2.5/NOPB	SOT-23	DBZ	3	3000	178.0	8.4	3.3	2.9	1.22	4.0	8.0	Q3
LM4040DIM3X-3.0/NOPB	SOT-23	DBZ	3	3000	178.0	8.4	3.3	2.9	1.22	4.0	8.0	Q3
LM4040DIM3X-4.1/NOPB	SOT-23	DBZ	3	3000	178.0	8.4	3.3	2.9	1.22	4.0	8.0	Q3
LM4040DIM3X-5.0	SOT-23	DBZ	3	3000	178.0	8.4	3.3	2.9	1.22	4.0	8.0	Q3
LM4040DIM3X-5.0/NOPB	SOT-23	DBZ	3	3000	178.0	8.4	3.3	2.9	1.22	4.0	8.0	Q3

Device	Package Type	Package Drawing	Pins	SPQ	Reel Diameter (mm)	Reel Width W1 (mm)	A0 (mm)	B0 (mm)	K0 (mm)	P1 (mm)	W (mm)	Pin1 Quadrant
LM4040DIM7-2.0/NOPB	SC70	DCK	5	1000	178.0	8.4	2.25	2.45	1.2	4.0	8.0	Q3
LM4040DIM7-2.5/NOPB	SC70	DCK	5	1000	178.0	8.4	2.25	2.45	1.2	4.0	8.0	Q3
LM4040DIM7-5.0	SC70	DCK	5	1000	178.0	8.4	2.25	2.45	1.2	4.0	8.0	Q3
LM4040DIM7-5.0/NOPB	SC70	DCK	5	1000	178.0	8.4	2.25	2.45	1.2	4.0	8.0	Q3
LM4040EEM3-2.5/NOPB	SOT-23	DBZ	3	1000	178.0	8.4	3.3	2.9	1.22	4.0	8.0	Q3
LM4040EIM3-2.5	SOT-23	DBZ	3	1000	178.0	8.4	3.3	2.9	1.22	4.0	8.0	Q3
LM4040EIM3-2.5/NOPB	SOT-23	DBZ	3	1000	178.0	8.4	3.3	2.9	1.22	4.0	8.0	Q3
LM4040EIM3-3.0/NOPB	SOT-23	DBZ	3	1000	178.0	8.4	3.3	2.9	1.22	4.0	8.0	Q3
LM4040EIM3X-2.5	SOT-23	DBZ	3	3000	178.0	8.4	3.3	2.9	1.22	4.0	8.0	Q3
LM4040EIM3X-2.5/NOPB	SOT-23	DBZ	3	3000	178.0	8.4	3.3	2.9	1.22	4.0	8.0	Q3
LM4040EIM3X-3.0/NOPB	SOT-23	DBZ	3	3000	178.0	8.4	3.3	2.9	1.22	4.0	8.0	Q3
LM4040EIM7-2.0/NOPB	SC70	DCK	5	1000	178.0	8.4	2.25	2.45	1.2	4.0	8.0	Q3
LM4040QAIM3-2.5/NOPB	SOT-23	DBZ	3	1000	178.0	8.4	3.3	2.9	1.22	4.0	8.0	Q3
LM4040QAIM3X2.5/NOPB	SOT-23	DBZ	3	3000	178.0	8.4	3.3	2.9	1.22	4.0	8.0	Q3
LM4040QBIM3-2.5/NOPB	SOT-23	DBZ	3	1000	178.0	8.4	3.3	2.9	1.22	4.0	8.0	Q3
LM4040QBIM3X2.5/NOPB	SOT-23	DBZ	3	3000	178.0	8.4	3.3	2.9	1.22	4.0	8.0	Q3
LM4040QCEM3-2.5/NOPB	SOT-23	DBZ	3	1000	178.0	8.4	3.3	2.9	1.22	4.0	8.0	Q3
LM4040QCEM3-3.0/NOPB	SOT-23	DBZ	3	1000	178.0	8.4	3.3	2.9	1.22	4.0	8.0	Q3
LM4040QCIM3-2.5/NOPB	SOT-23	DBZ	3	1000	178.0	8.4	3.3	2.9	1.22	4.0	8.0	Q3
LM4040QCIM3X2.5/NOPB	SOT-23	DBZ	3	3000	178.0	8.4	3.3	2.9	1.22	4.0	8.0	Q3
LM4040QDEM3-2.5/NOPB	SOT-23	DBZ	3	1000	178.0	8.4	3.3	2.9	1.22	4.0	8.0	Q3
LM4040QDEM3-3.0/NOPB	SOT-23	DBZ	3	1000	178.0	8.4	3.3	2.9	1.22	4.0	8.0	Q3
LM4040QDIM3-2.5/NOPB	SOT-23	DBZ	3	1000	178.0	8.4	3.3	2.9	1.22	4.0	8.0	Q3
LM4040QDIM3X2.5/NOPB	SOT-23	DBZ	3	3000	178.0	8.4	3.3	2.9	1.22	4.0	8.0	Q3
LM4040QEEM3-2.5/NOPB	SOT-23	DBZ	3	1000	178.0	8.4	3.3	2.9	1.22	4.0	8.0	Q3
LM4040QEEM3-3.0/NOPB	SOT-23	DBZ	3	1000	178.0	8.4	3.3	2.9	1.22	4.0	8.0	Q3
LM4040QEIM3-2.5/NOPB	SOT-23	DBZ	3	1000	178.0	8.4	3.3	2.9	1.22	4.0	8.0	Q3
LM4040QEIM3X2.5/NOPB	SOT-23	DBZ	3	3000	178.0	8.4	3.3	2.9	1.22	4.0	8.0	Q3

**TAPE AND REEL BOX DIMENSIONS**

\*All dimensions are nominal

Device	Package Type	Package Drawing	Pins	SPQ	Length (mm)	Width (mm)	Height (mm)
LM4040AIM3-10.0	SOT-23	DBZ	3	1000	210.0	185.0	35.0
LM4040AIM3-10.0/NOPB	SOT-23	DBZ	3	1000	210.0	185.0	35.0
LM4040AIM3-2.0	SOT-23	DBZ	3	1000	210.0	185.0	35.0
LM4040AIM3-2.0/NOPB	SOT-23	DBZ	3	1000	210.0	185.0	35.0
LM4040AIM3-2.5	SOT-23	DBZ	3	1000	210.0	185.0	35.0
LM4040AIM3-2.5/NOPB	SOT-23	DBZ	3	1000	210.0	185.0	35.0
LM4040AIM3-3.0/NOPB	SOT-23	DBZ	3	1000	210.0	185.0	35.0
LM4040AIM3-4.1	SOT-23	DBZ	3	1000	210.0	185.0	35.0
LM4040AIM3-4.1/NOPB	SOT-23	DBZ	3	1000	210.0	185.0	35.0
LM4040AIM3-5.0	SOT-23	DBZ	3	1000	210.0	185.0	35.0
LM4040AIM3-5.0/NOPB	SOT-23	DBZ	3	1000	210.0	185.0	35.0
LM4040AIM3X-10/NOPB	SOT-23	DBZ	3	3000	210.0	185.0	35.0
LM4040AIM3X-2.0/NOPB	SOT-23	DBZ	3	3000	210.0	185.0	35.0
LM4040AIM3X-2.5	SOT-23	DBZ	3	3000	210.0	185.0	35.0
LM4040AIM3X-2.5/NOPB	SOT-23	DBZ	3	3000	210.0	185.0	35.0
LM4040AIM3X-3.0/NOPB	SOT-23	DBZ	3	3000	210.0	185.0	35.0
LM4040AIM3X-4.1/NOPB	SOT-23	DBZ	3	3000	210.0	185.0	35.0
LM4040AIM3X-5.0	SOT-23	DBZ	3	3000	210.0	185.0	35.0
LM4040AIM3X-5.0/NOPB	SOT-23	DBZ	3	3000	210.0	185.0	35.0
LM4040BIM3-10.0	SOT-23	DBZ	3	1000	210.0	185.0	35.0

Device	Package Type	Package Drawing	Pins	SPQ	Length (mm)	Width (mm)	Height (mm)
LM4040BIM3-10.0/NOPB	SOT-23	DBZ	3	1000	210.0	185.0	35.0
LM4040BIM3-2.0/NOPB	SOT-23	DBZ	3	1000	210.0	185.0	35.0
LM4040BIM3-2.5	SOT-23	DBZ	3	1000	210.0	185.0	35.0
LM4040BIM3-2.5/NOPB	SOT-23	DBZ	3	1000	210.0	185.0	35.0
LM4040BIM3-3.0	SOT-23	DBZ	3	1000	210.0	185.0	35.0
LM4040BIM3-3.0/NOPB	SOT-23	DBZ	3	1000	210.0	185.0	35.0
LM4040BIM3-4.1	SOT-23	DBZ	3	1000	210.0	185.0	35.0
LM4040BIM3-4.1/NOPB	SOT-23	DBZ	3	1000	210.0	185.0	35.0
LM4040BIM3-5.0	SOT-23	DBZ	3	1000	210.0	185.0	35.0
LM4040BIM3-5.0/NOPB	SOT-23	DBZ	3	1000	210.0	185.0	35.0
LM4040BIM3-8.2	SOT-23	DBZ	3	1000	210.0	185.0	35.0
LM4040BIM3-8.2/NOPB	SOT-23	DBZ	3	1000	210.0	185.0	35.0
LM4040BIM3X-10/NOPB	SOT-23	DBZ	3	3000	210.0	185.0	35.0
LM4040BIM3X-2.0/NOPB	SOT-23	DBZ	3	3000	210.0	185.0	35.0
LM4040BIM3X-2.5	SOT-23	DBZ	3	3000	210.0	185.0	35.0
LM4040BIM3X-2.5/NOPB	SOT-23	DBZ	3	3000	210.0	185.0	35.0
LM4040BIM3X-3.0/NOPB	SOT-23	DBZ	3	3000	210.0	185.0	35.0
LM4040BIM3X-4.1	SOT-23	DBZ	3	3000	210.0	185.0	35.0
LM4040BIM3X-4.1/NOPB	SOT-23	DBZ	3	3000	210.0	185.0	35.0
LM4040BIM3X-5.0/NOPB	SOT-23	DBZ	3	3000	210.0	185.0	35.0
LM4040BIM7-2.0/NOPB	SC70	DCK	5	1000	210.0	185.0	35.0
LM4040BIM7-2.5	SC70	DCK	5	1000	210.0	185.0	35.0
LM4040BIM7-2.5/NOPB	SC70	DCK	5	1000	210.0	185.0	35.0
LM4040BIM7-5.0/NOPB	SC70	DCK	5	1000	210.0	185.0	35.0
LM4040BIM7X-2.5/NOPB	SC70	DCK	5	3000	210.0	185.0	35.0
LM4040CEM3-2.5	SOT-23	DBZ	3	1000	210.0	185.0	35.0
LM4040CEM3-2.5/NOPB	SOT-23	DBZ	3	1000	210.0	185.0	35.0
LM4040CEM3-3.0/NOPB	SOT-23	DBZ	3	1000	210.0	185.0	35.0
LM4040CEM3-5.0	SOT-23	DBZ	3	1000	210.0	185.0	35.0
LM4040CEM3-5.0/NOPB	SOT-23	DBZ	3	1000	210.0	185.0	35.0
LM4040CEM3X-3.0/NOPB	SOT-23	DBZ	3	3000	210.0	185.0	35.0
LM4040CEM3X-5.0/NOPB	SOT-23	DBZ	3	3000	210.0	185.0	35.0
LM4040CIM3-10.0	SOT-23	DBZ	3	1000	210.0	185.0	35.0
LM4040CIM3-10.0/NOPB	SOT-23	DBZ	3	1000	210.0	185.0	35.0
LM4040CIM3-2.0	SOT-23	DBZ	3	1000	210.0	185.0	35.0
LM4040CIM3-2.0/NOPB	SOT-23	DBZ	3	1000	210.0	185.0	35.0
LM4040CIM3-2.5	SOT-23	DBZ	3	1000	210.0	185.0	35.0
LM4040CIM3-2.5/NOPB	SOT-23	DBZ	3	1000	210.0	185.0	35.0
LM4040CIM3-3.0	SOT-23	DBZ	3	1000	210.0	185.0	35.0
LM4040CIM3-3.0/NOPB	SOT-23	DBZ	3	1000	210.0	185.0	35.0
LM4040CIM3-4.1	SOT-23	DBZ	3	1000	210.0	185.0	35.0
LM4040CIM3-4.1/NOPB	SOT-23	DBZ	3	1000	210.0	185.0	35.0
LM4040CIM3-5.0	SOT-23	DBZ	3	1000	210.0	185.0	35.0
LM4040CIM3-5.0/NOPB	SOT-23	DBZ	3	1000	210.0	185.0	35.0

Device	Package Type	Package Drawing	Pins	SPQ	Length (mm)	Width (mm)	Height (mm)
LM4040CIM3-8.2	SOT-23	DBZ	3	1000	210.0	185.0	35.0
LM4040CIM3-8.2/NOPB	SOT-23	DBZ	3	1000	210.0	185.0	35.0
LM4040CIM3X-10/NOPB	SOT-23	DBZ	3	3000	210.0	185.0	35.0
LM4040CIM3X-2.0/NOPB	SOT-23	DBZ	3	3000	210.0	185.0	35.0
LM4040CIM3X-2.5	SOT-23	DBZ	3	3000	210.0	185.0	35.0
LM4040CIM3X-2.5/NOPB	SOT-23	DBZ	3	3000	210.0	185.0	35.0
LM4040CIM3X-3.0/NOPB	SOT-23	DBZ	3	3000	210.0	185.0	35.0
LM4040CIM3X-4.1/NOPB	SOT-23	DBZ	3	3000	210.0	185.0	35.0
LM4040CIM3X-5.0	SOT-23	DBZ	3	3000	210.0	185.0	35.0
LM4040CIM3X-5.0/NOPB	SOT-23	DBZ	3	3000	210.0	185.0	35.0
LM4040CIM7-2.0/NOPB	SC70	DCK	5	1000	210.0	185.0	35.0
LM4040CIM7-2.5/NOPB	SC70	DCK	5	1000	210.0	185.0	35.0
LM4040CIM7X-2.5/NOPB	SC70	DCK	5	3000	210.0	185.0	35.0
LM4040DEM3-2.0	SOT-23	DBZ	3	1000	210.0	185.0	35.0
LM4040DEM3-2.0/NOPB	SOT-23	DBZ	3	1000	210.0	185.0	35.0
LM4040DEM3-2.5/NOPB	SOT-23	DBZ	3	1000	210.0	185.0	35.0
LM4040DEM3-3.0/NOPB	SOT-23	DBZ	3	1000	210.0	185.0	35.0
LM4040DEM3-5.0	SOT-23	DBZ	3	1000	210.0	185.0	35.0
LM4040DEM3-5.0/NOPB	SOT-23	DBZ	3	1000	210.0	185.0	35.0
LM4040DEM3X-2.5/NOPB	SOT-23	DBZ	3	3000	210.0	185.0	35.0
LM4040DEM3X-5.0/NOPB	SOT-23	DBZ	3	3000	210.0	185.0	35.0
LM4040DIM3-10.0	SOT-23	DBZ	3	1000	210.0	185.0	35.0
LM4040DIM3-10.0/NOPB	SOT-23	DBZ	3	1000	210.0	185.0	35.0
LM4040DIM3-2.0/NOPB	SOT-23	DBZ	3	1000	210.0	185.0	35.0
LM4040DIM3-2.5	SOT-23	DBZ	3	1000	210.0	185.0	35.0
LM4040DIM3-2.5/NOPB	SOT-23	DBZ	3	1000	210.0	185.0	35.0
LM4040DIM3-3.0/NOPB	SOT-23	DBZ	3	1000	210.0	185.0	35.0
LM4040DIM3-4.1	SOT-23	DBZ	3	1000	210.0	185.0	35.0
LM4040DIM3-4.1/NOPB	SOT-23	DBZ	3	1000	210.0	185.0	35.0
LM4040DIM3-5.0	SOT-23	DBZ	3	1000	210.0	185.0	35.0
LM4040DIM3-5.0/NOPB	SOT-23	DBZ	3	1000	210.0	185.0	35.0
LM4040DIM3-8.2/NOPB	SOT-23	DBZ	3	1000	210.0	185.0	35.0
LM4040DIM3X-10/NOPB	SOT-23	DBZ	3	3000	210.0	185.0	35.0
LM4040DIM3X-2.0/NOPB	SOT-23	DBZ	3	3000	210.0	185.0	35.0
LM4040DIM3X-2.5	SOT-23	DBZ	3	3000	210.0	185.0	35.0
LM4040DIM3X-2.5/NOPB	SOT-23	DBZ	3	3000	210.0	185.0	35.0
LM4040DIM3X-3.0/NOPB	SOT-23	DBZ	3	3000	210.0	185.0	35.0
LM4040DIM3X-4.1/NOPB	SOT-23	DBZ	3	3000	210.0	185.0	35.0
LM4040DIM3X-5.0	SOT-23	DBZ	3	3000	210.0	185.0	35.0
LM4040DIM3X-5.0/NOPB	SOT-23	DBZ	3	3000	210.0	185.0	35.0
LM4040DIM7-2.0/NOPB	SC70	DCK	5	1000	210.0	185.0	35.0
LM4040DIM7-2.5/NOPB	SC70	DCK	5	1000	210.0	185.0	35.0
LM4040DIM7-5.0	SC70	DCK	5	1000	210.0	185.0	35.0
LM4040DIM7-5.0/NOPB	SC70	DCK	5	1000	210.0	185.0	35.0

Device	Package Type	Package Drawing	Pins	SPQ	Length (mm)	Width (mm)	Height (mm)
LM4040EEM3-2.5/NOPB	SOT-23	DBZ	3	1000	210.0	185.0	35.0
LM4040EIM3-2.5	SOT-23	DBZ	3	1000	210.0	185.0	35.0
LM4040EIM3-2.5/NOPB	SOT-23	DBZ	3	1000	210.0	185.0	35.0
LM4040EIM3-3.0/NOPB	SOT-23	DBZ	3	1000	210.0	185.0	35.0
LM4040EIM3X-2.5	SOT-23	DBZ	3	3000	210.0	185.0	35.0
LM4040EIM3X-2.5/NOPB	SOT-23	DBZ	3	3000	210.0	185.0	35.0
LM4040EIM3X-3.0/NOPB	SOT-23	DBZ	3	3000	210.0	185.0	35.0
LM4040EIM7-2.0/NOPB	SC70	DCK	5	1000	210.0	185.0	35.0
LM4040QAIM3-2.5/NOPB	SOT-23	DBZ	3	1000	210.0	185.0	35.0
LM4040QAIM3X2.5/NOPB	SOT-23	DBZ	3	3000	210.0	185.0	35.0
LM4040QBIM3-2.5/NOPB	SOT-23	DBZ	3	1000	210.0	185.0	35.0
LM4040QBIM3X2.5/NOPB	SOT-23	DBZ	3	3000	210.0	185.0	35.0
LM4040QCEM3-2.5/NOPB	SOT-23	DBZ	3	1000	210.0	185.0	35.0
LM4040QCEM3-3.0/NOPB	SOT-23	DBZ	3	1000	210.0	185.0	35.0
LM4040QCIM3-2.5/NOPB	SOT-23	DBZ	3	1000	210.0	185.0	35.0
LM4040QCIM3X2.5/NOPB	SOT-23	DBZ	3	3000	210.0	185.0	35.0
LM4040QDEM3-2.5/NOPB	SOT-23	DBZ	3	1000	210.0	185.0	35.0
LM4040QDEM3-3.0/NOPB	SOT-23	DBZ	3	1000	210.0	185.0	35.0
LM4040QDIM3-2.5/NOPB	SOT-23	DBZ	3	1000	210.0	185.0	35.0
LM4040QDIM3X2.5/NOPB	SOT-23	DBZ	3	3000	210.0	185.0	35.0
LM4040QEEM3-2.5/NOPB	SOT-23	DBZ	3	1000	210.0	185.0	35.0
LM4040QEEM3-3.0/NOPB	SOT-23	DBZ	3	1000	210.0	185.0	35.0
LM4040QEIM3-2.5/NOPB	SOT-23	DBZ	3	1000	210.0	185.0	35.0
LM4040QEIM3X2.5/NOPB	SOT-23	DBZ	3	3000	210.0	185.0	35.0

DCK (R-PDSO-G5)

PLASTIC SMALL-OUTLINE PACKAGE



- NOTES:
- A. All linear dimensions are in millimeters.
  - B. This drawing is subject to change without notice.
  - C. Body dimensions do not include mold flash or protrusion. Mold flash and protrusion shall not exceed 0.15 per side.
  - D. Falls within JEDEC MO-203 variation AA.

DCK (R-PDSO-G5)

PLASTIC SMALL OUTLINE



- NOTES:
- All linear dimensions are in millimeters.
  - This drawing is subject to change without notice.
  - Customers should place a note on the circuit board fabrication drawing not to alter the center solder mask defined pad.
  - Publication IPC-7351 is recommended for alternate designs.
  - Laser cutting apertures with trapezoidal walls and also rounding corners will offer better paste release. Customers should contact their board assembly site for stencil design recommendations. Example stencil design based on a 50% volumetric metal load solder paste. Refer to IPC-7525 for other stencil recommendations.

## GENERIC PACKAGE VIEW

**DBZ 3**

**SOT-23 - 1.12 mm max height**

SMALL OUTLINE TRANSISTOR



Images above are just a representation of the package family, actual package may vary.  
Refer to the product data sheet for package details.

4203227/C

# DBZ0003A



# PACKAGE OUTLINE

## SOT-23 - 1.12 mm max height

SMALL OUTLINE TRANSISTOR

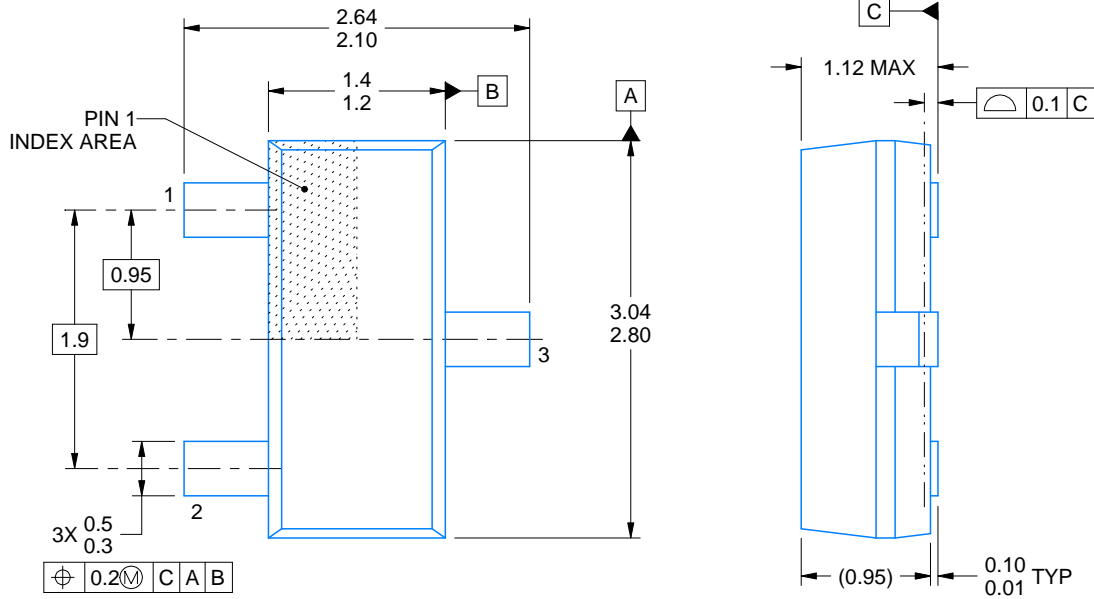

4214838/C 04/2017

### NOTES:

1. All linear dimensions are in millimeters. Any dimensions in parenthesis are for reference only. Dimensioning and tolerancing per ASME Y14.5M.
2. This drawing is subject to change without notice.
3. Reference JEDEC registration TO-236, except minimum foot length.

# EXAMPLE BOARD LAYOUT

DBZ0003A

SOT-23 - 1.12 mm max height

SMALL OUTLINE TRANSISTOR



LAND PATTERN EXAMPLE  
SCALE:15X

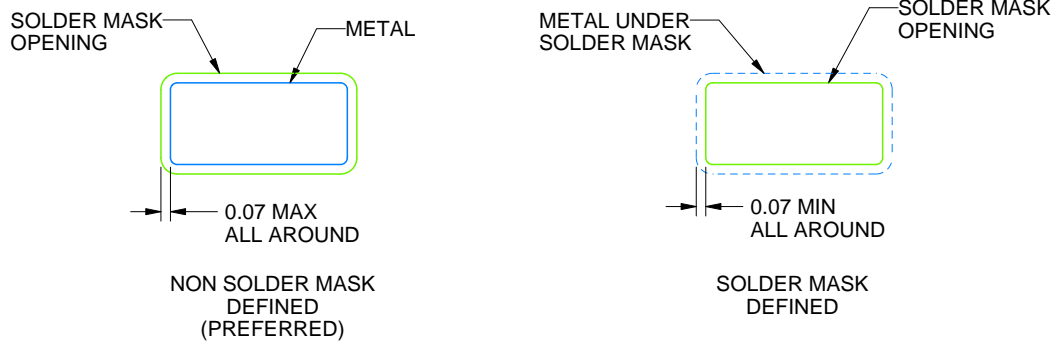

SOLDER MASK DETAILS

4214838/C 04/2017

NOTES: (continued)

4. Publication IPC-7351 may have alternate designs.
5. Solder mask tolerances between and around signal pads can vary based on board fabrication site.

# EXAMPLE STENCIL DESIGN

DBZ0003A

SOT-23 - 1.12 mm max height

SMALL OUTLINE TRANSISTOR



SOLDER PASTE EXAMPLE  
BASED ON 0.125 THICK STENCIL  
SCALE:15X

4214838/C 04/2017

NOTES: (continued)

6. Laser cutting apertures with trapezoidal walls and rounded corners may offer better paste release. IPC-7525 may have alternate design recommendations.
7. Board assembly site may have different recommendations for stencil design.

## GENERIC PACKAGE VIEW

LP 3

TO-92 - 5.34 mm max height

TRANSISTOR OUTLINE



Images above are just a representation of the package family, actual package may vary.  
Refer to the product data sheet for package details.

4040001-2/F

LP0003A



PACKAGE OUTLINE

TO-92 - 5.34 mm max height

TO-92



4215214/B 04/2017

NOTES:

1. All linear dimensions are in millimeters. Any dimensions in parenthesis are for reference only. Dimensioning and tolerancing per ASME Y14.5M.
2. This drawing is subject to change without notice.
3. Lead dimensions are not controlled within this area.
4. Reference JEDEC TO-226, variation AA.
5. Shipping method:
  - a. Straight lead option available in bulk pack only.
  - b. Formed lead option available in tape and reel or ammo pack.
  - c. Specific products can be offered in limited combinations of shipping medium and lead options.
  - d. Consult product folder for more information on available options.



LAND PATTERN EXAMPLE  
STRAIGHT LEAD OPTION  
NON-SOLDER MASK DEFINED  
SCALE:15X



LAND PATTERN EXAMPLE  
FORMED LEAD OPTION  
NON-SOLDER MASK DEFINED  
SCALE:15X

# TAPE SPECIFICATIONS

LP0003A

TO-92 - 5.34 mm max height

TO-92

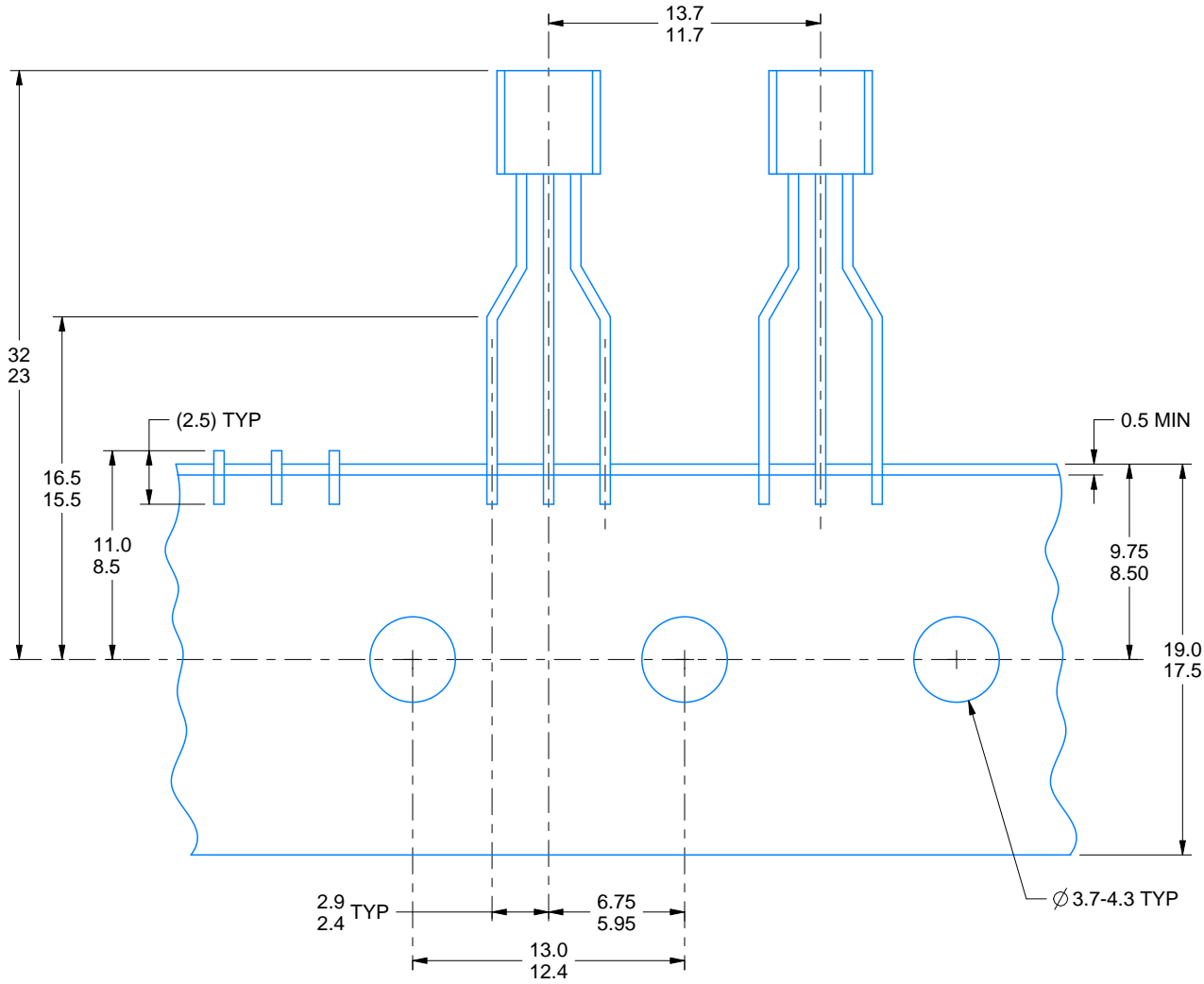

FOR FORMED LEAD OPTION PACKAGE

4215214/B 04/2017

## IMPORTANT NOTICE AND DISCLAIMER

TI PROVIDES TECHNICAL AND RELIABILITY DATA (INCLUDING DATASHEETS), DESIGN RESOURCES (INCLUDING REFERENCE DESIGNS), APPLICATION OR OTHER DESIGN ADVICE, WEB TOOLS, SAFETY INFORMATION, AND OTHER RESOURCES "AS IS" AND WITH ALL FAULTS, AND DISCLAIMS ALL WARRANTIES, EXPRESS AND IMPLIED, INCLUDING WITHOUT LIMITATION ANY IMPLIED WARRANTIES OF MERCHANTABILITY, FITNESS FOR A PARTICULAR PURPOSE OR NON-INFRINGEMENT OF THIRD PARTY INTELLECTUAL PROPERTY RIGHTS.

These resources are intended for skilled developers designing with TI products. You are solely responsible for (1) selecting the appropriate TI products for your application, (2) designing, validating and testing your application, and (3) ensuring your application meets applicable standards, and any other safety, security, or other requirements. These resources are subject to change without notice. TI grants you permission to use these resources only for development of an application that uses the TI products described in the resource. Other reproduction and display of these resources is prohibited. No license is granted to any other TI intellectual property right or to any third party intellectual property right. TI disclaims responsibility for, and you will fully indemnify TI and its representatives against, any claims, damages, costs, losses, and liabilities arising out of your use of these resources.

TI's products are provided subject to TI's Terms of Sale ([www.ti.com/legal/termsofsale.html](http://www.ti.com/legal/termsofsale.html)) or other applicable terms available either on [ti.com](http://ti.com) or provided in conjunction with such TI products. TI's provision of these resources does not expand or otherwise alter TI's applicable warranties or warranty disclaimers for TI products.

Mailing Address: Texas Instruments, Post Office Box 655303, Dallas, Texas 75265  
Copyright © 2019, Texas Instruments Incorporated

## Looking for pricing, stock, or lifecycle information?

Click below to explore more details on WIN SOURCE:

 [View LM4040CEM3-2.5/NOPB on WIN SOURCE](#)

 [Texas Instruments](#) Information

## Optimize Your Supply Chain with WIN SOURCE Solutions

-  Global Sourcing Solution
-  Obsolete Management
-  Cost Control Management
-  Shortage Management
-  Alternative Solution
-  Excess Inventory Management