



**THE DATASHEET OF
TPS22920YZPT**



TPS22920x 3.6-V, 4-A, 5.3-mΩ On-Resistance, Integrated Load Switch with Controlled Turn-on

1 Features

- Input Voltage Range: 0.75 V to 3.6 V
- Integrated Load Switch
- Integrated Pass-FET $r_{\text{DS(ON)}} = 2 \text{ m}\Omega$ (Typ) at 3.6 V
- Typical ON-Resistance
 - $r_{\text{ON}} = 5.3 \text{ m}\Omega$ at $V_{\text{IN}} = 3.6 \text{ V}$
 - $r_{\text{ON}} = 5.4 \text{ m}\Omega$ at $V_{\text{IN}} = 2.5 \text{ V}$
 - $r_{\text{ON}} = 5.5 \text{ m}\Omega$ at $V_{\text{IN}} = 1.8 \text{ V}$
 - $r_{\text{ON}} = 5.8 \text{ m}\Omega$ at $V_{\text{IN}} = 1.2 \text{ V}$
 - $r_{\text{ON}} = 6.1 \text{ m}\Omega$ at $V_{\text{IN}} = 1.05 \text{ V}$
 - $r_{\text{ON}} = 7.3 \text{ m}\Omega$ at $V_{\text{IN}} = 0.75 \text{ V}$
- CSP-8 Package 0.9 mm × 1.9 mm, 0.5 mm Pitch
- 4-A Maximum Continuous Switch Current
- Shutdown Current 5.5- μA Max
- ON-Logic Available in Both Active High/Low:
 - TPS22920 is Active High
 - TPS22920L is Active Low
- Low Threshold Control Input
- Controlled Slew-Rate to Avoid Inrush Current
- Quick Output Discharge Resistor
- ESD Performance Tested Per JESD 22
 - 4000-V Human-Body Model (A114-B, Class II)
 - 1000-V Charged-Device Model (C101)

2 Applications

- Notebook / Netbook Computer
- Tablet PC
- PDAs / Smartphones
- GPS Navigation Devices
- MP3 Players

3 Description

The TPS22920x is a small, space-saving load switch with controlled turn on to reduce inrush current. The device contains a N-channel MOSFET that can operate over an input voltage range of 0.75 V to 3.6 V and switch currents up to 4 A. An integrated charge pump biases the NMOS switch in order to achieve a minimum switch ON resistance (r_{ON}). The switch is controlled by an on/off input (ON), which is capable of interfacing directly with low-voltage control signals.

The TPS22920x has a 1250- Ω on-chip resistor for quick output discharge when the switch is turned off which insures that the output is not left floating.

The TPS22920x has an internally controlled rise time in order to reduce inrush current.

The TPS22920x is available in an ultra-small, space-saving 8-pin CSP package and is characterized for operation over the free-air temperature range of -40°C to 85°C .

Device Information⁽¹⁾

PART NUMBER	PACKAGE	BODY SIZE (NOM)
TPS22920x	DSBGA (8)	1.90 mm x 0.90 mm

(1) For all available packages, see the orderable addendum at the end of the datasheet.

Typical Application

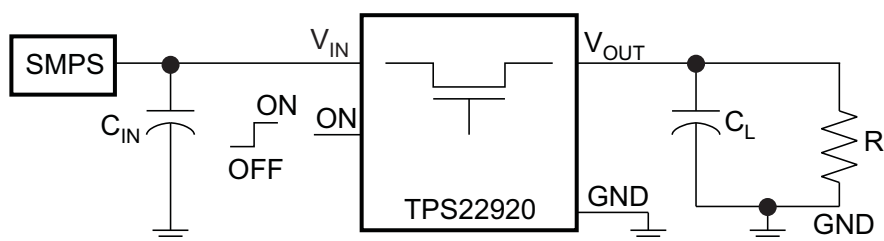

Table of Contents

1	Features	1	9	Detailed Description	15
2	Applications	1	9.1	Overview	15
3	Description	1	9.2	Functional Block Diagram	15
4	Revision History	2	9.3	Feature Description	15
5	Device Comparison Table	3	9.4	Device Functional Modes	15
6	Pin Configuration and Functions	3	10	Application and Implementation	16
7	Specifications	4	10.1	Application Information	16
7.1	Absolute Maximum Ratings	4	10.2	Typical Application	16
7.2	ESD Ratings	4	11	Power Supply Recommendations	19
7.3	Recommended Operating Conditions	4	12	Layout	19
7.4	Thermal Information	4	12.1	Layout Guidelines	19
7.5	Electrical Characteristics	5	12.2	Layout Example	19
7.6	Switching Characteristics: $V_{IN} = 3.6\text{ V}$	5	13	Device and Documentation Support	20
7.7	Switching Characteristics: $V_{IN} = 0.9\text{ V}$	5	13.1	Related Links	20
7.8	Typical DC Characteristics	6	13.2	Trademarks	20
7.9	TPS22920 Typical AC Characteristics	7	13.3	Electrostatic Discharge Caution	20
7.10	TPS22920L Typical AC Characteristics	10	13.4	Glossary	20
8	Parametric Measurement Information	13	14	Mechanical, Packaging, and Orderable Information	20

4 Revision History

Changes from Revision C (April 2015) to Revision D	Page
• Added Information about backside coating to <i>Device Comparison</i> table	3

Changes from Revision November 2014 (B) to Revision C	Page
• Added TPS22920L to the datasheet.	1

Changes from Revision A (July 2013) to Revision B	Page
• Added <i>Pin Configuration and Functions</i> section, <i>Handling Rating</i> table, <i>Feature Description</i> section, <i>Device Functional Modes</i> , <i>Application and Implementation</i> section, <i>Power Supply Recommendations</i> section, <i>Layout</i> section, <i>Device and Documentation Support</i> section, and <i>Mechanical, Packaging, and Orderable Information</i> section	1

Changes from Original (June 2011) to Revision A	Page
• Updated swapped image issue.	7

5 Device Comparison Table

ORDERABLE PART NUMBER	R _{ON} (TYP) AT 3.6 V	RISE TIME (TYP) at 3.6V	QUICK OUTPUT DISCHARGE ⁽¹⁾	BACKSIDE COATING ⁽²⁾	ENABLE
TPS22920YZPR	5.3 mΩ	880 μS	Yes	No	Active High
TPS22920YZPRB	5.3 mΩ	880 μS	Yes	Yes	Active High
TPS22920LYZPR	5.3 mΩ	627 μS	Yes	Yes	Active Low

(1) This feature discharges the output of the switch to ground through a 1250-Ω resistor, preventing the output from floating. See [Output Pull-Down](#).

(2) CSP (DSBGA) devices manufactured with backside coating have an increased resistance to cracking due to the increased physical strength of the package. Devices with backside coating are highly encouraged for new designs.

6 Pin Configuration and Functions

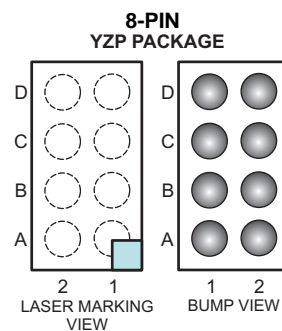

Pin Functions

PIN		I/O	DESCRIPTION
NAME	NO.		
GND	D1	-	Ground
ON	D2	I	Switch control input. Do not leave floating
V _{OUT}	A1, B1, C1	O	Switch output
V _{IN}	A2, B2, C2	I	Switch input, bypass this input with a ceramic capacitor to ground

Table 1. Bump Assignments (YZP Package)

D	GND	ON
C	V _{OUT}	V _{IN}
B	V _{OUT}	V _{IN}
A	V _{OUT}	V _{IN}
	1	2

7 Specifications

7.1 Absolute Maximum Ratings⁽¹⁾

		MIN	MAX	UNIT
V _{IN}	Input voltage range	-0.3	4	V
V _{OUT}	Output voltage range		V _{IN} + 0.3	V
V _{ON}	Input voltage range	-0.3	4	V
I _{MAX}	Maximum Continuous Switch Current		4	A
I _{PLS}	Maximum Pulsed Switch Current, pulse <300 μs, 2% duty cycle		6	A
T _J	Maximum junction temperature		125	°C
T _{stg}	Storage temperature range	-65	150	°C

- (1) Stresses beyond those listed under Absolute Maximum Ratings may cause permanent damage to the device. These are stress only, and functional operation of the device at these or any other conditions beyond those indicated under [Recommended Operating Conditions](#) is not implied. Exposure to absolute-maximum-rated conditions for extended periods may affect device reliability.

7.2 ESD Ratings

		VALUE	UNIT
V _(ESD)	Electrostatic discharge	Human-body model (HBM), per ANSI/ESDA/JEDEC JS-001 ⁽¹⁾	±4000
		Charged-device model (CDM), per JEDEC specification JESD22-C101 ⁽²⁾	±1000

- (1) JEDEC document JEP155 states that 500-V HBM allows safe manufacturing with a standard ESD control process. Manufacturing with less than 500-V HBM is possible with the necessary precautions.
- (2) JEDEC document JEP157 states that 250-V CDM allows safe manufacturing with a standard ESD control process. Manufacturing with less than 250-V CDM is possible with the necessary precautions.

7.3 Recommended Operating Conditions

		MIN	MAX	UNIT	
V _{IN}	Input voltage range	0.75	3.6	V	
V _{OUT}	Output voltage range		V _{IN}	V	
V _{IH}	High-level input voltage, ON	V _{IN} = 2.5 V to 3.6 V	1.2	3.6	V
		V _{IN} = 0.75 V to 2.49 V	0.9	3.6	V
V _{IL}	Low-level input voltage, ON	V _{IN} = 2.5 V to 3.6 V		0.6	V
		V _{IN} = 0.75 V to 2.49 V		0.4	V
T _A	Operating free-air temperature range	-40	85	°C	
C _{IN}	Input Capacitor	1 ⁽¹⁾		μF	

- (1) See [Input Capacitor](#) section in Application Information.

7.4 Thermal Information

THERMAL METRIC ⁽¹⁾	TPS22920x		UNIT
	YZP		
	8 PINS		
R _{θJA}	Junction-to-ambient thermal resistance	130	°C/W
R _{θJC(top)}	Junction-to-case (top) thermal resistance	54	
R _{θJB}	Junction-to-board thermal resistance	51	
ψ _{JT}	Junction-to-top characterization parameter	1	
ψ _{JB}	Junction-to-board characterization parameter	50	

- (1) For more information about traditional and new thermal metrics, see the *IC Package Thermal Metrics* application report, [SPRA953](#).

7.5 Electrical Characteristics

Unless otherwise noted, $V_{IN} = 0.75\text{ V}$ to 3.6 V

PARAMETER		TEST CONDITIONS		T_A	MIN	TYP ⁽¹⁾	MAX	UNIT
I_{IN}	Quiescent Current	$I_{OUT} = 0$, Switch enabled	$V_{IN} = 3.6\text{ V}$	Full		68	160	μA
			$V_{IN} = 2.5\text{ V}$			40	70	
			$V_{IN} = 1.8\text{ V}$			25	350	μA
			$V_{IN} = 1.2\text{ V}$			103	200	
			$V_{IN} = 1.05\text{ V}$			78	110	μA
			$V_{IN} = 0.75\text{ V}$			37	70	
$I_{IN(Leak)}$	Off Supply Current (After Pull Down)	Switch disabled, $V_{OUT} = 0$		Full			5.5	μA
r_{ON}	On-Resistance		$V_{IN} = 3.6\text{ V}$, $I_{OUT} = -200\text{ mA}$	25°C	5.3	8.8	$\text{m}\Omega$	
				Full		9.8		
			$V_{IN} = 2.5\text{ V}$, $I_{OUT} = -200\text{ mA}$	25°C	5.4	8.9	$\text{m}\Omega$	
				Full		9.9		
			$V_{IN} = 1.8\text{ V}$, $I_{OUT} = -200\text{ mA}$	25°C	5.5	9.1	$\text{m}\Omega$	
				Full		10.1		
			$V_{IN} = 1.2\text{ V}$, $I_{OUT} = -200\text{ mA}$	25°C	5.8	9.4	$\text{m}\Omega$	
				Full		10.4		
			$V_{IN} = 1.05\text{ V}$, $I_{OUT} = -200\text{ mA}$	25°C	6.1	9.7	$\text{m}\Omega$	
				Full		10.8		
			$V_{IN} = 0.75\text{ V}$, $I_{OUT} = -200\text{ mA}$	25°C	7.3	11.0	$\text{m}\Omega$	
				Full		12.4		
RPD	Output pull down resistance ⁽²⁾	$V_{IN} = 3.3\text{ V}$, Switch disabled, $I_{OUT} = 3\text{ mA}$		Full	1250	1500	Ω	
I_{ON}	ON input leakage current	$V_{ON} = 0.9\text{ V}$ to 3.6 V or GND		Full			0.1	μA

(1) Typical values are at $V_{IN} = 3.3\text{ V}$ and $T_A = 25^\circ\text{C}$.

(2) See [Output Pull-Down](#).

7.6 Switching Characteristics: $V_{IN} = 3.6\text{ V}$

$T_A = 25^\circ\text{C}$ (unless otherwise noted)

PARAMETER	TEST CONDITION	TPS22920	TPS22920L	UNIT	
		TYP	TYP		
t_{ON}	Turn-ON time	$R_L = 10\ \Omega$, $C_L = 0.1\ \mu\text{F}$, $V_{IN} = 3.6\text{ V}$	970	663	μs
t_{OFF}	Turn-OFF time	$R_L = 10\ \Omega$, $C_L = 0.1\ \mu\text{F}$, $V_{IN} = 3.6\text{ V}$	3	2	
t_r	VOUT Rise time	$R_L = 10\ \Omega$, $C_L = 0.1\ \mu\text{F}$, $V_{IN} = 3.6\text{ V}$	880	627	
t_f	VOUT Fall time	$R_L = 10\ \Omega$, $C_L = 0.1\ \mu\text{F}$, $V_{IN} = 3.6\text{ V}$	2	2	

7.7 Switching Characteristics: $V_{IN} = 0.9\text{ V}$

$T_A = 25^\circ\text{C}$ (unless otherwise noted)

PARAMETER	TEST CONDITION	TPS22920	TPS22920L	UNIT	
		TYP	TYP		
t_{ON}	Turn-ON time	$R_L = 10\ \Omega$, $C_L = 0.1\ \mu\text{F}$, $V_{IN} = 0.9\text{ V}$	840	840	μs
t_{OFF}	Turn-OFF time	$R_L = 10\ \Omega$, $C_L = 0.1\ \mu\text{F}$, $V_{IN} = 0.9\text{ V}$	16	16	
t_r	VOUT Rise time	$R_L = 10\ \Omega$, $C_L = 0.1\ \mu\text{F}$, $V_{IN} = 0.9\text{ V}$	470	470	
t_f	VOUT Fall time	$R_L = 10\ \Omega$, $C_L = 0.1\ \mu\text{F}$, $V_{IN} = 0.9\text{ V}$	5	5	

7.8 Typical DC Characteristics

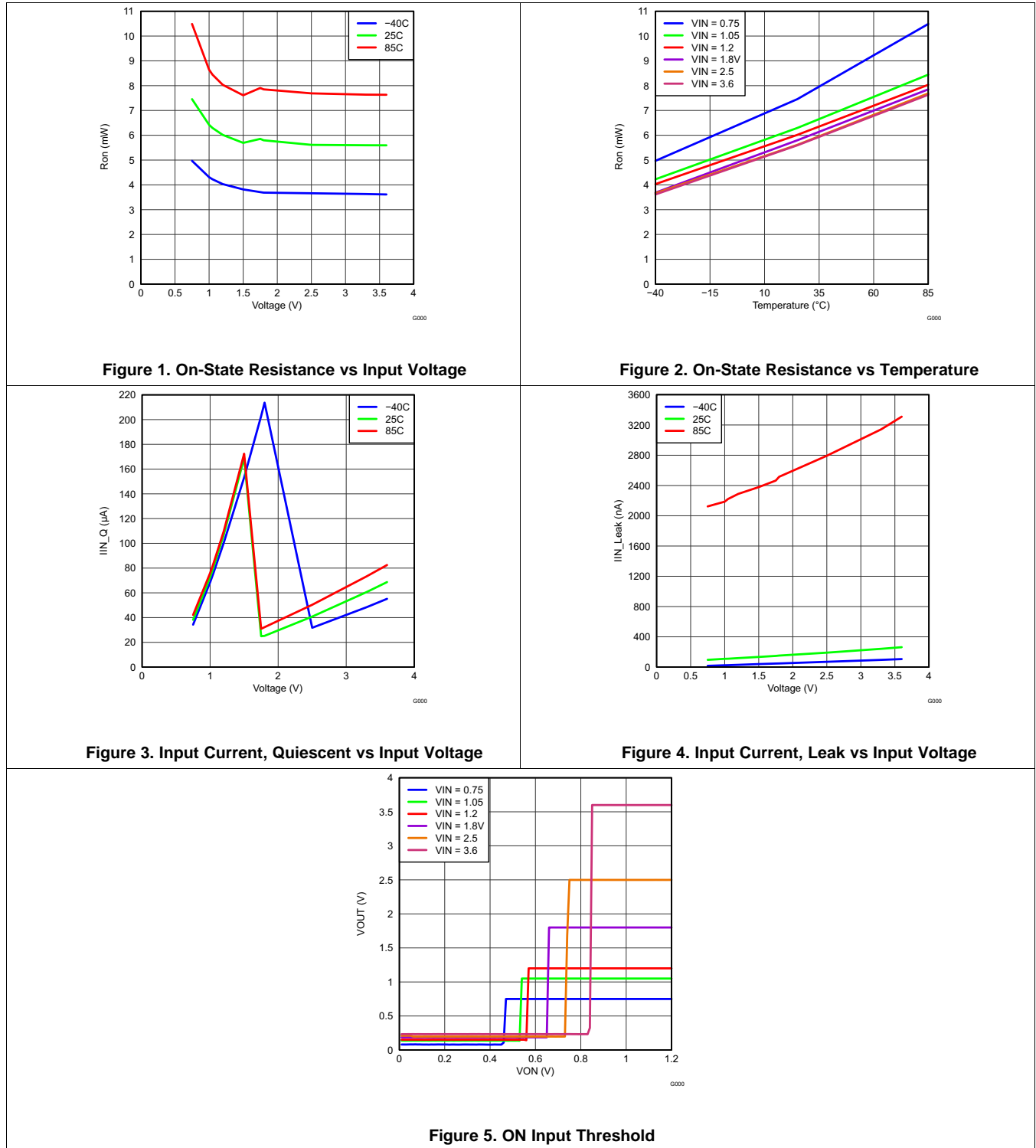

7.9 TPS22920 Typical AC Characteristics

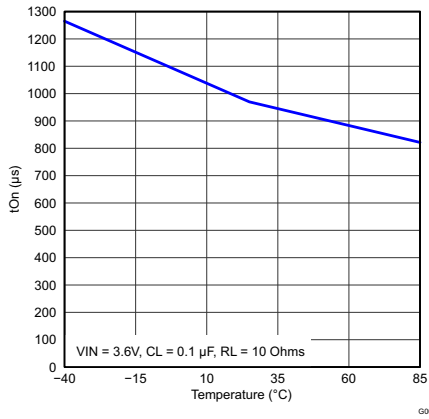

Figure 6. Turn-On Time vs Temperature

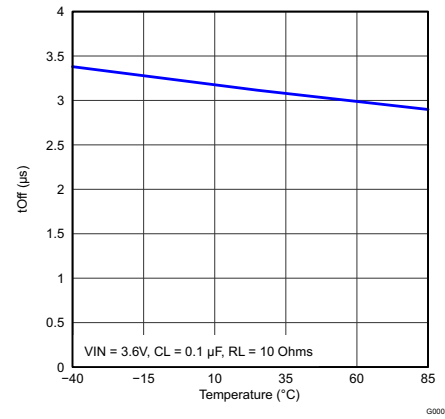

Figure 7. Turn-Off Time vs Temperature

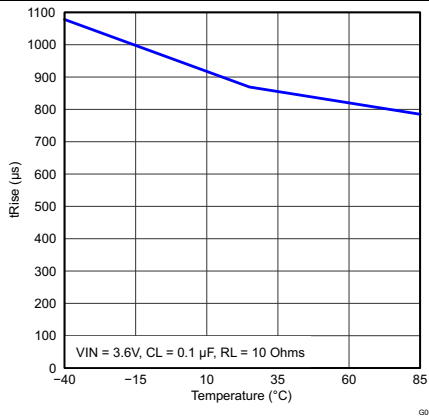

Figure 8. Rise Time vs Temperature

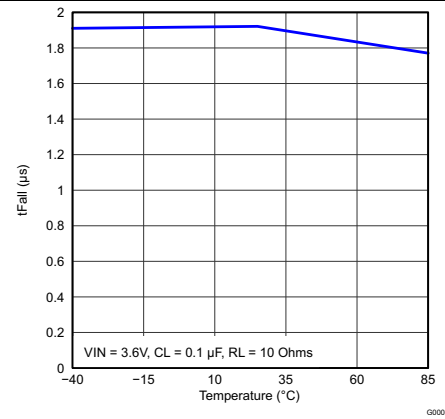

Figure 9. Fall Time vs Temperature

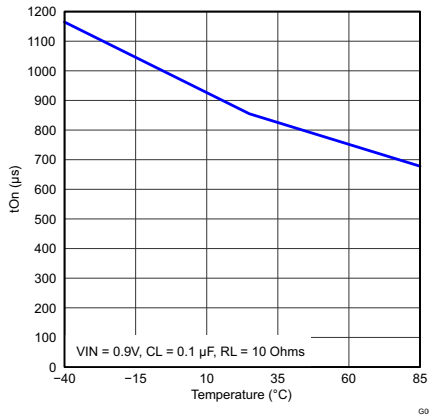

Figure 10. Turn-On Time vs Temperature

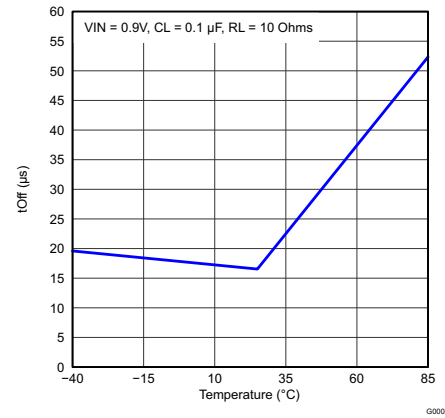

Figure 11. Turn-Off Time vs Temperature

TPS22920 Typical AC Characteristics (continued)

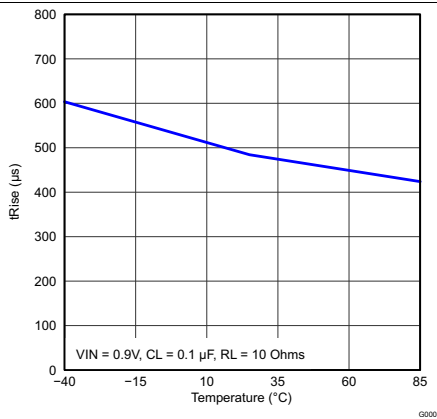

Figure 12. Rise Time vs Temperature

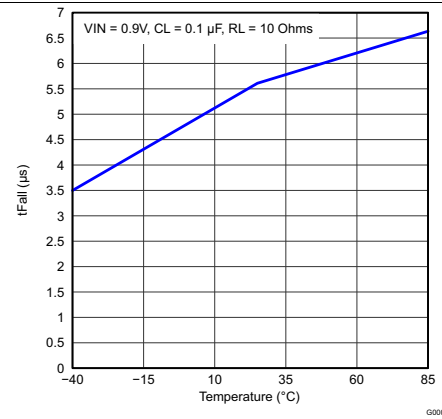

Figure 13. Fall Time vs Temperature

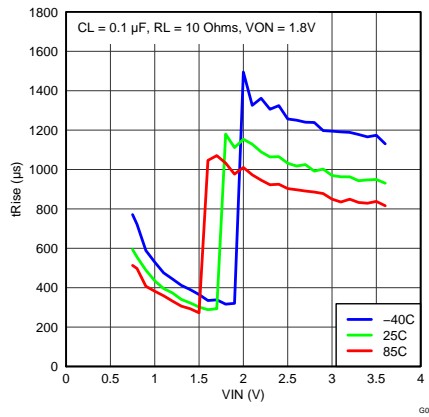

Figure 14. Rise Time vs Input Voltage

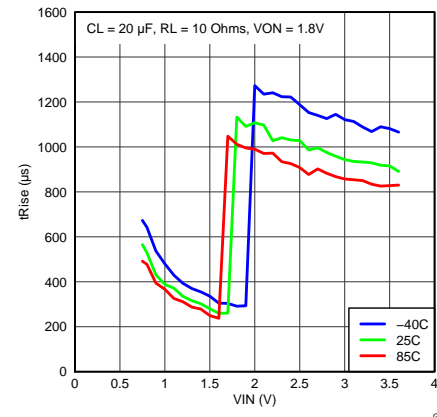

Figure 15. Rise Time vs Input Voltage

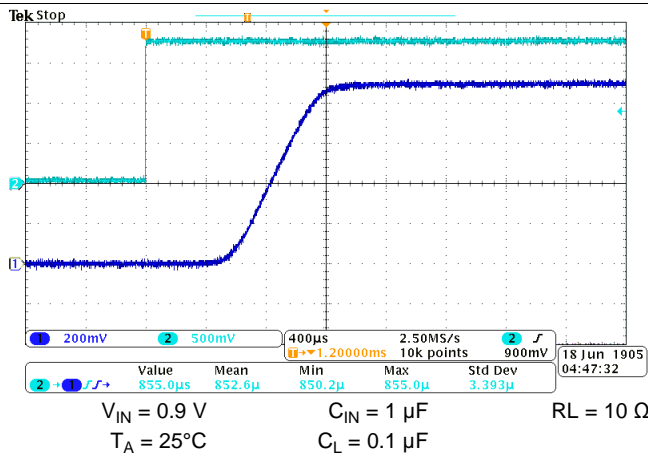

Figure 16. Turn-On Response

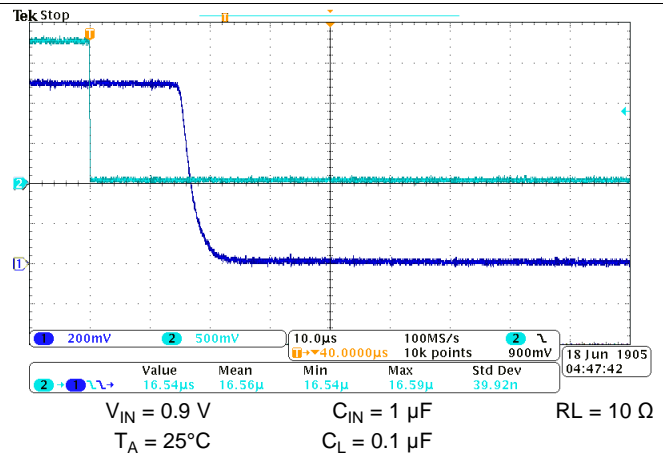

Figure 17. Turn-Off Response

TPS22920 Typical AC Characteristics (continued)

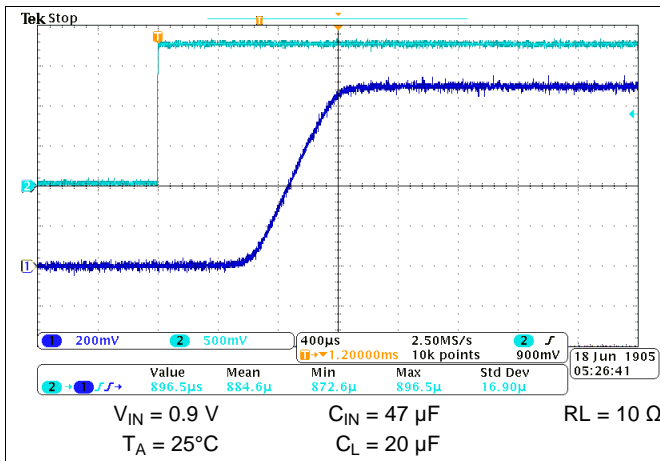

Figure 18. Turn-On Response

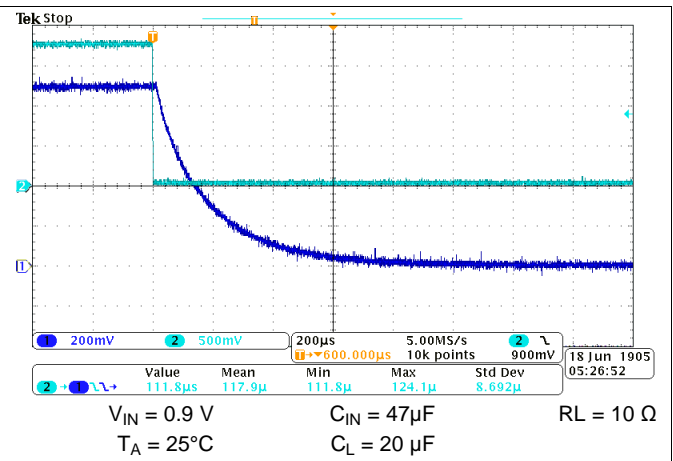

Figure 19. Turn-Off Response

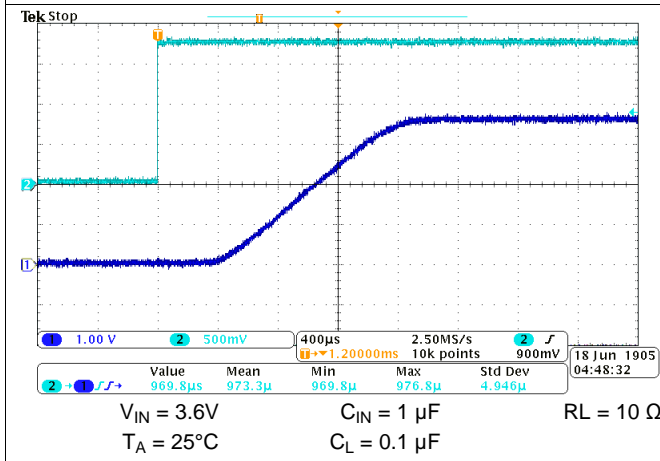

Figure 20. Turn-On Response

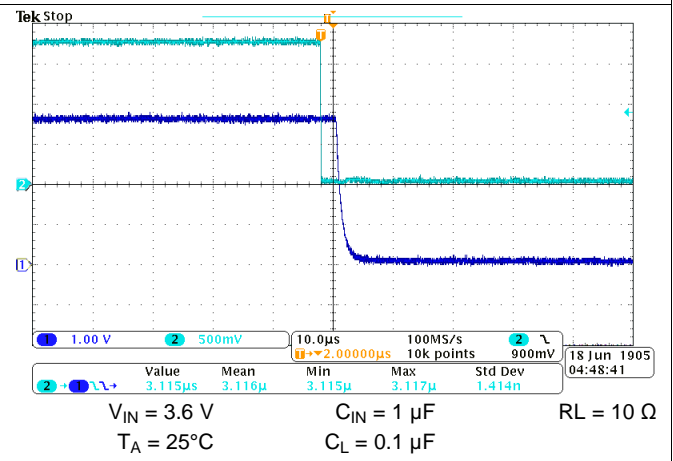

Figure 21. Turn-Off Response

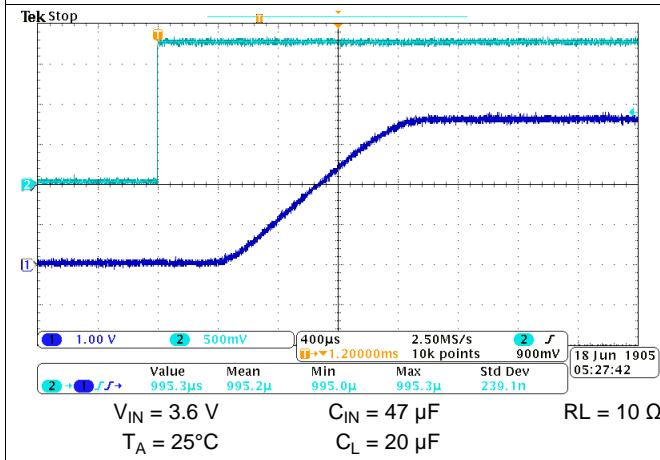

Figure 22. Turn-On Response

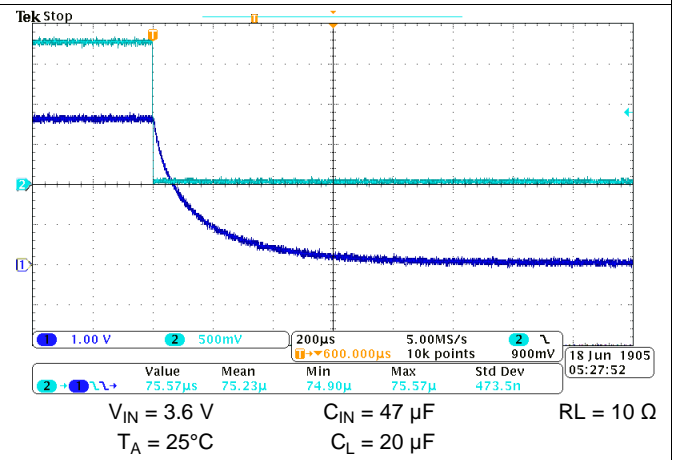

Figure 23. Turn-Off Response

7.10 TPS22920L Typical AC Characteristics

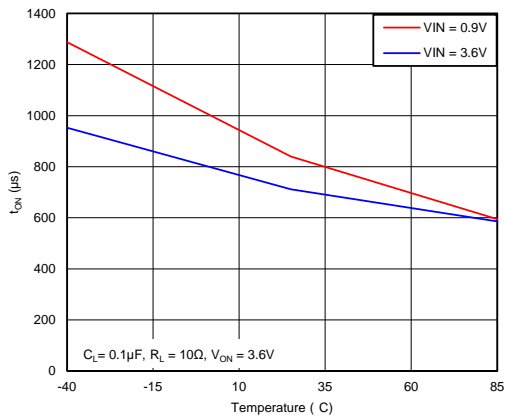

Figure 24. t_{ON} vs Temperature

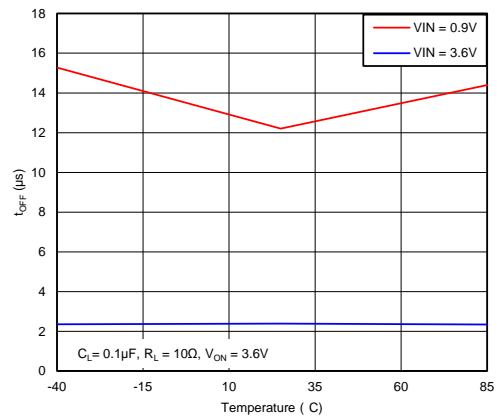

Figure 25. t_{OFF} vs Temperature

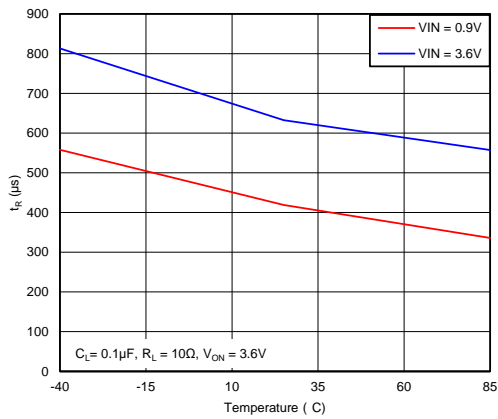

Figure 26. t_R vs Temperature

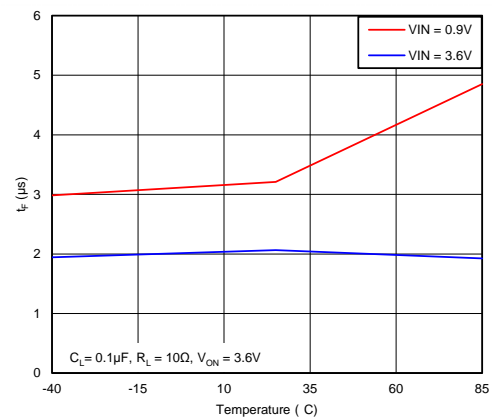

Figure 27. t_F vs Temperature

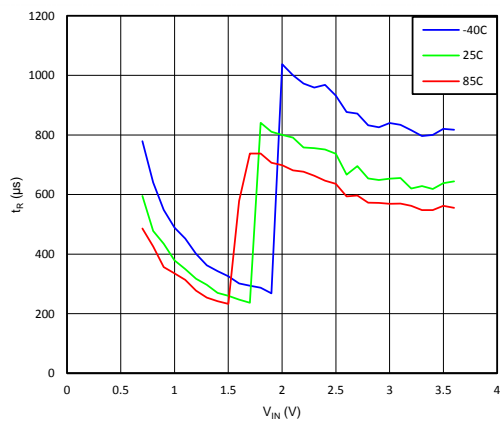

Figure 28. t_R vs V_{IN}

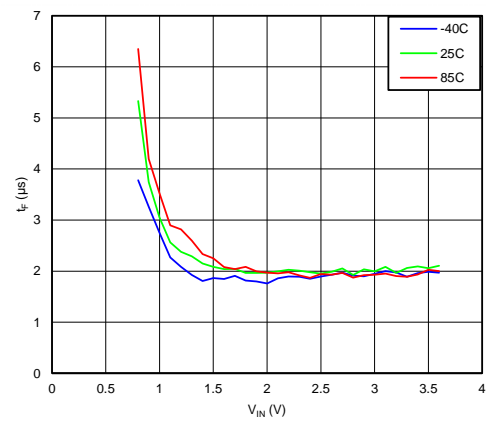

Figure 29. t_F vs V_{IN}

TPS22920L Typical AC Characteristics (continued)

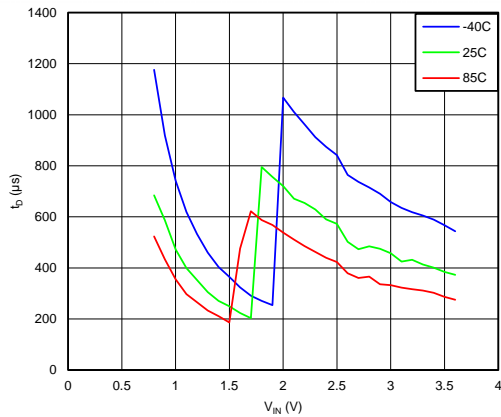

Figure 30. t_D vs V_{IN}

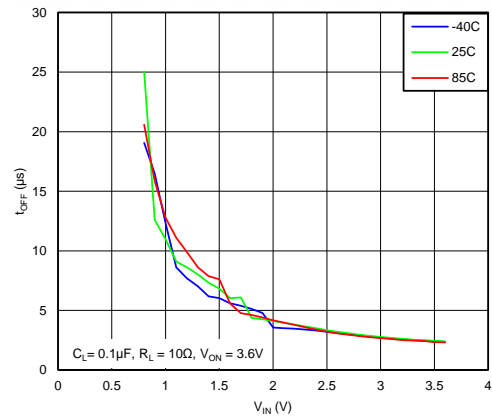

Figure 31. t_{OFF} vs V_{IN}

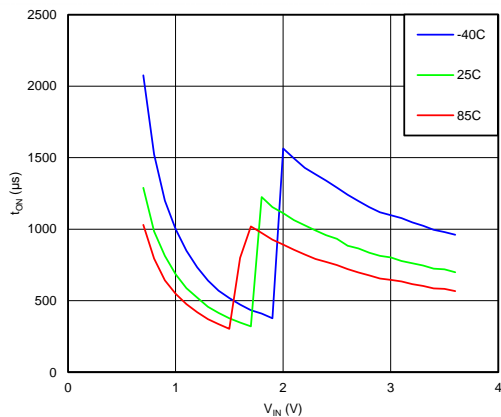

Figure 32. t_{ON} vs V_{IN}

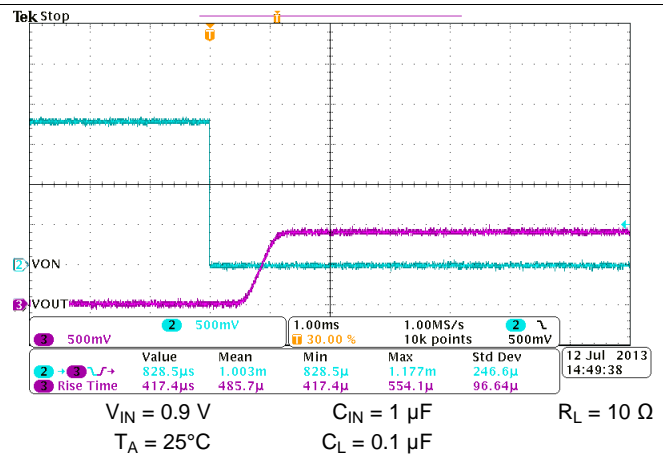

Figure 33. Turn-On Response

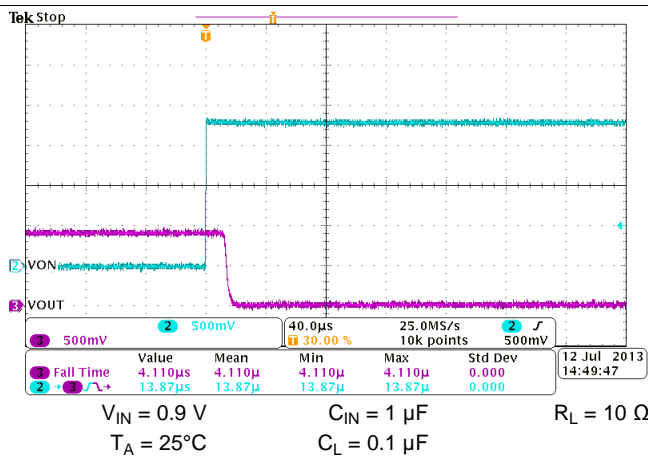

Figure 34. Turn-Off Response

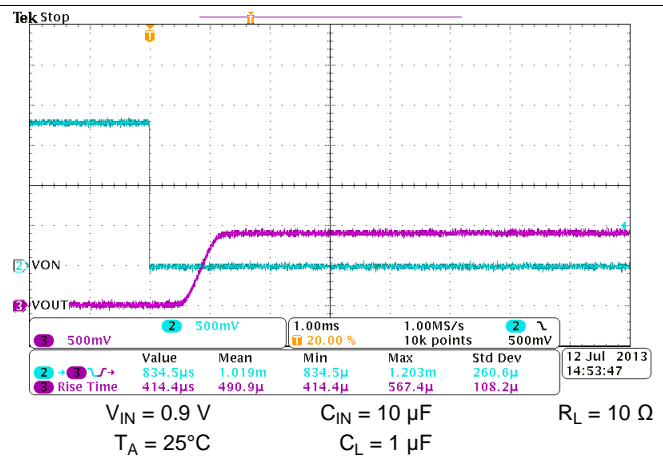

Figure 35. Turn-On Response

TPS22920L Typical AC Characteristics (continued)

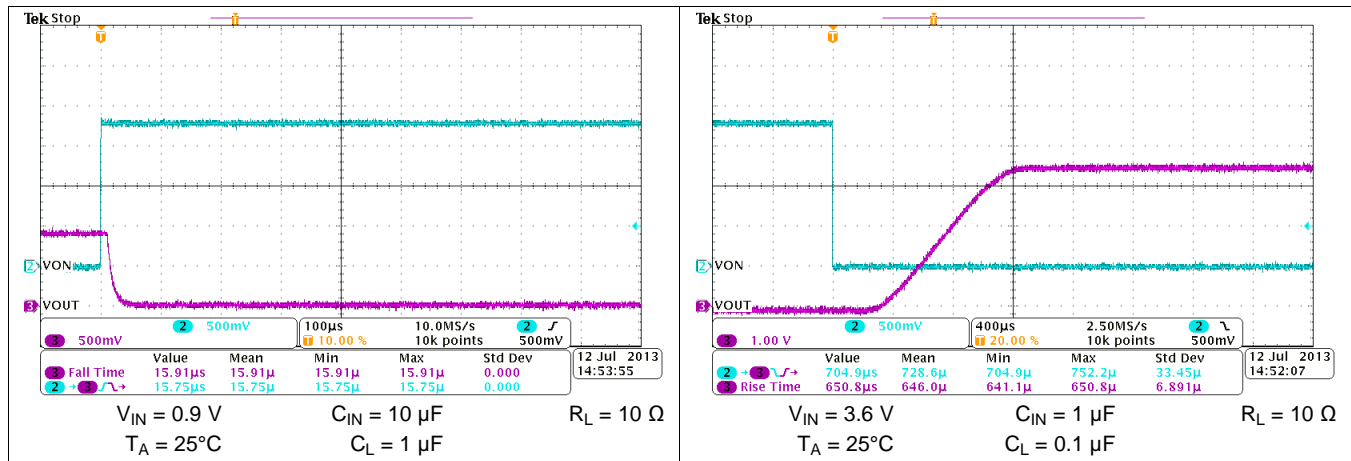

Figure 36. Turn-Off Response

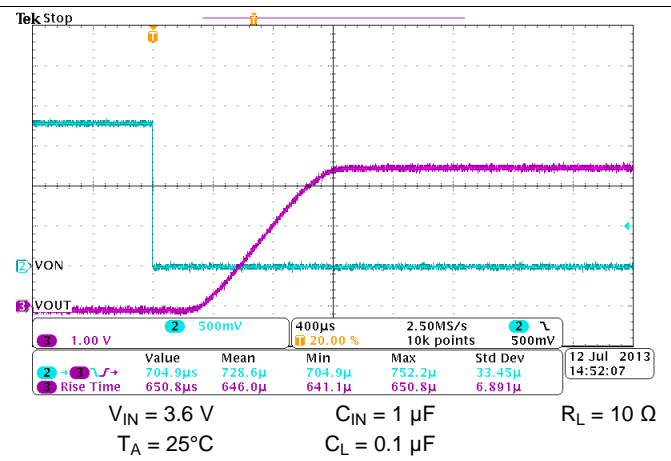

Figure 37. Turn-On Response

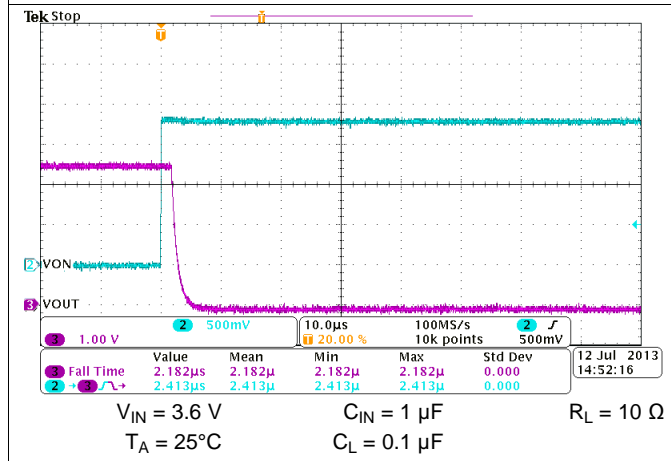

Figure 38. Turn-Off Response

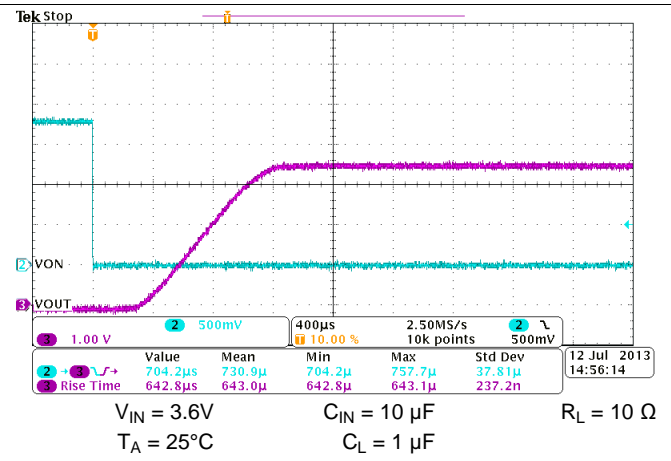

Figure 39. Turn-On Response

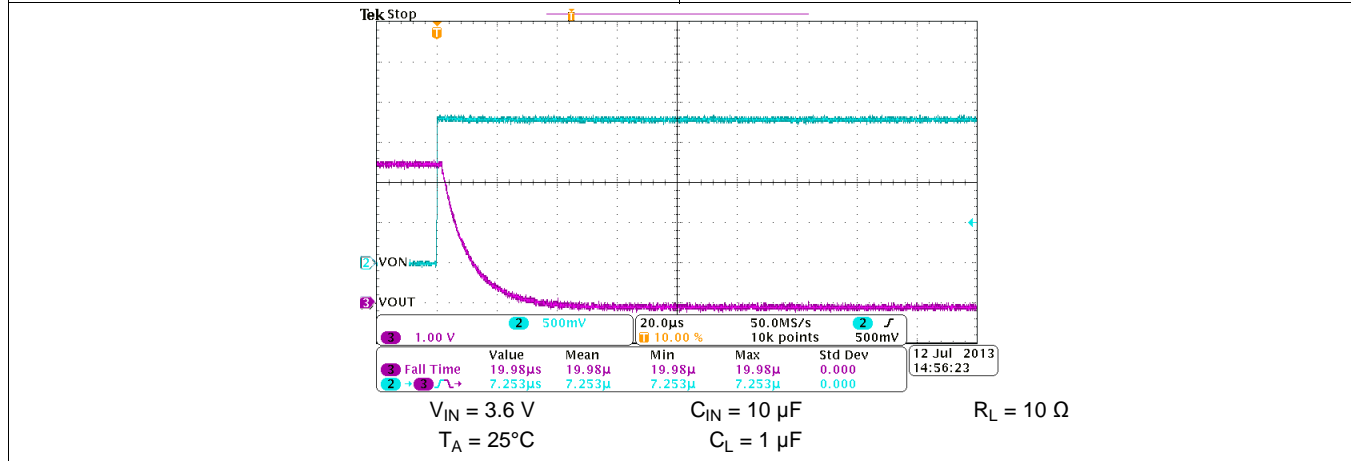
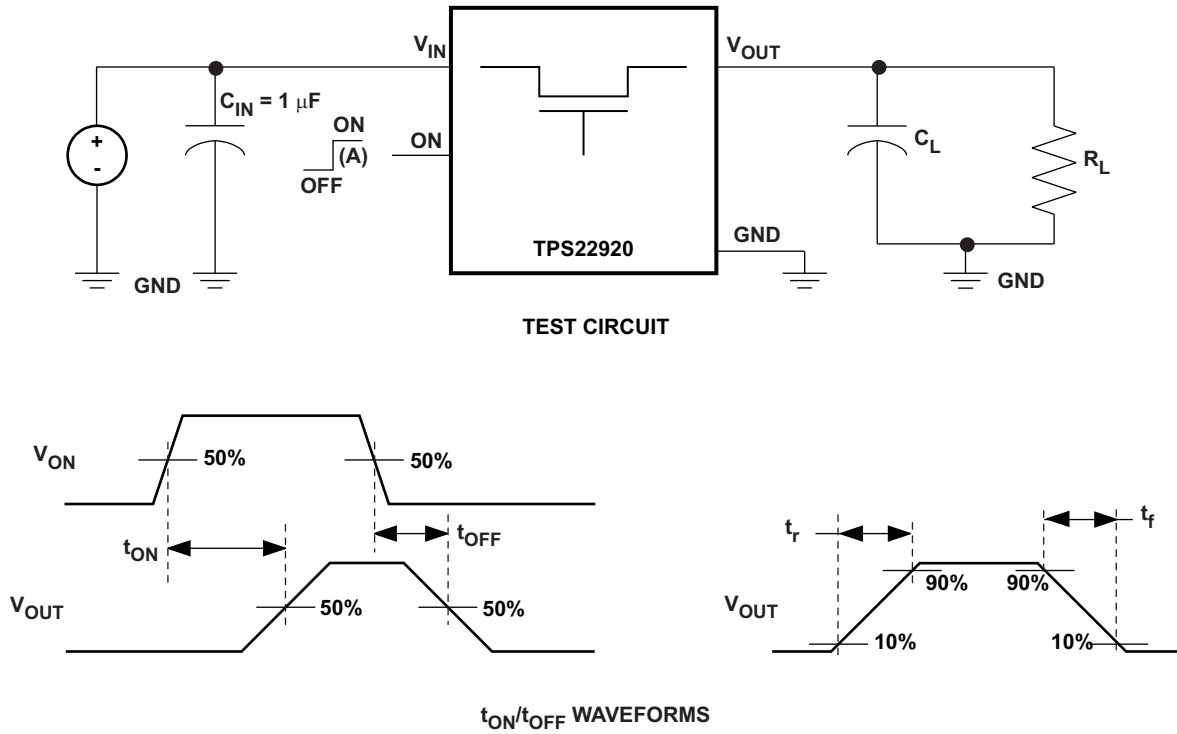

Figure 40. Turn-Off Response

8 Parametric Measurement Information



(A) Rise and fall times of the control signal is 100 ns.

Figure 41. TPS22920 Test Circuit and T_{ON}/T_{OFF} Waveforms

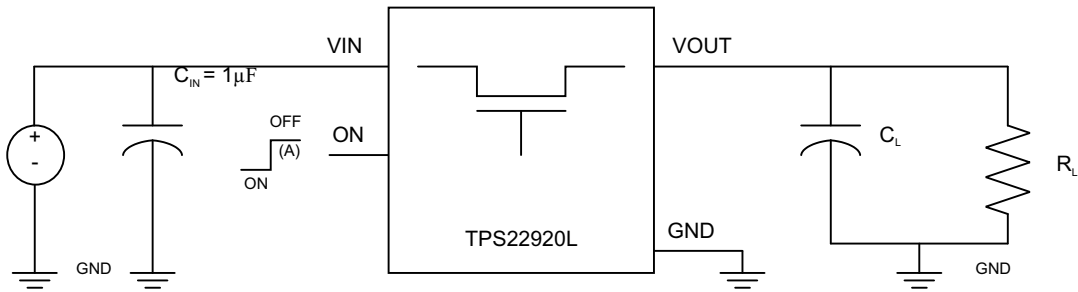
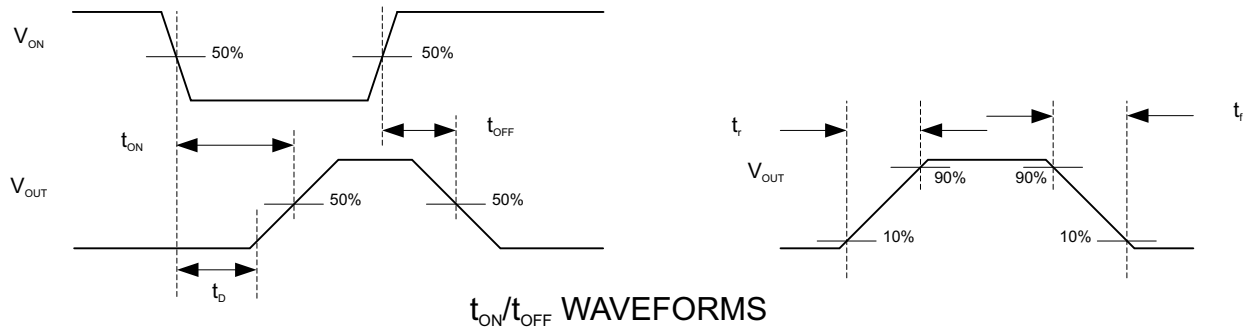
Parametric Measurement Information (continued)

TEST CIRCUIT

- A. Rise and fall times of the control signal is 100ns.

Figure 42. TPS22920L Test Circuit and t_{ON}/t_{OFF} Waveforms

9 Detailed Description

9.1 Overview

The TPS22920x is a single channel, 4-A load switch in a small, space-saving CSP-8 package. This device implements a low resistance N-channel MOSFET with a controlled rise time for applications that need to limit the inrush current.

This device is also designed to have very low leakage current during off state, which prevents downstream circuits from pulling high standby current from the supply. Integrated control logic, driver, power supply, and output discharge FET eliminates the need for additional external components, which reduces solution size and bill of materials (BOM) count.

9.2 Functional Block Diagram

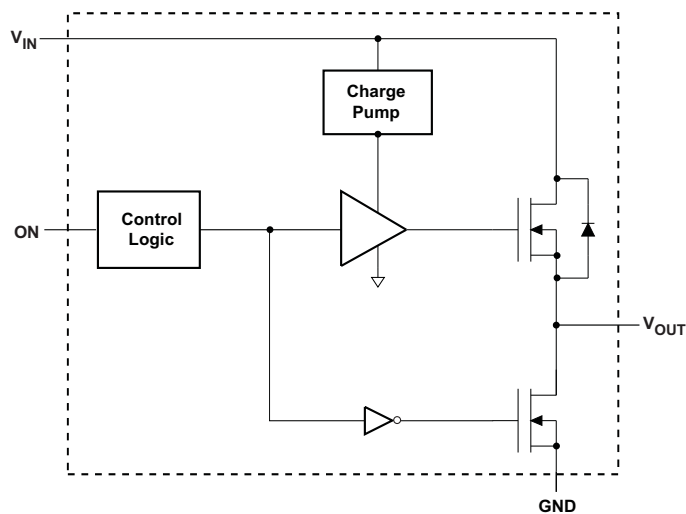

9.3 Feature Description

9.3.1 ON/OFF Control

The ON pin controls the state of the switch. For TPS22920, asserting ON high enables the switch. For TPS22920L, asserting ON low enables the switch. ON has a low threshold, making it capable of interfacing with low-voltage signals. The ON pin is compatible with standard GPIO logic threshold. It can be used with any microcontroller with 1.2-V, 1.8-V, 2.5-V or 3.3-V GPIOs.

9.3.2 Output Pull-Down

The output pull-down is active when the user is turning off the main pass FET. The pull-down discharges the output rail to approximately 10% of the rail, and then the output pull-down is automatically disconnected to optimize the shutdown current.

9.4 Device Functional Modes

ON	TPS22920		TPS22920L	
	V_{IN} to V_{OUT}	V_{OUT} to GND ⁽¹⁾	V_{IN} to V_{OUT}	V_{OUT} to GND ⁽¹⁾
Logic Low	OFF	ON	ON	OFF
Logic High	ON	OFF	OFF	ON

(1) See [Output Pull-Down](#).

10 Application and Implementation

NOTE

Information in the following applications sections is not part of the TI component specification, and TI does not warrant its accuracy or completeness. TI's customers are responsible for determining suitability of components for their purposes. Customers should validate and test their design implementation to confirm system functionality.

10.1 Application Information

10.1.1 Input Capacitor

To limit the voltage drop on the input supply caused by transient inrush currents when the switch turns on into a discharged load capacitor or short-circuit, a capacitor needs to be placed between V_{IN} and GND. A 1- μF ceramic capacitor, C_{IN} , placed close to the pins is usually sufficient. Higher values of C_{IN} can be used to further reduce the voltage drop.

10.1.2 Output Capacitor

A C_{IN} greater than C_L is highly recommended due to the integral body diode in the NMOS switch. A C_L greater than C_{IN} can cause V_{OUT} to exceed V_{IN} when the system supply is removed. This could result in current flow through the body diode from V_{OUT} to V_{IN} . A C_{IN} to C_L ratio of 10 to 1 is recommended for minimizing V_{IN} dip caused by inrush currents during startup.

10.2 Typical Application

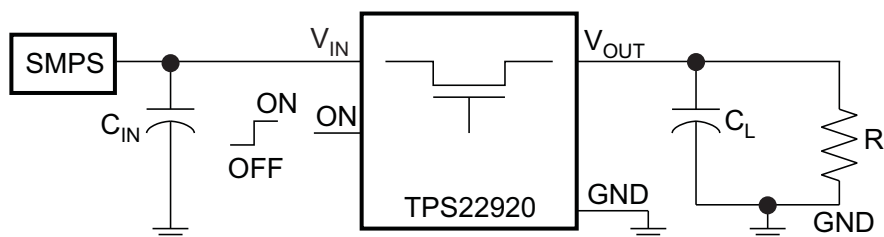

Figure 43. Typical Application Circuit

10.2.1 Design Requirements

DESIGN PARAMETER	EXAMPLE VALUE
V_{IN}	3.3 V
C_L	4.7 μF
Maximum Acceptable Inrush Current	40 mA

10.2.2 Detailed Design Procedure

10.2.2.1 VIN to VOUT Voltage Drop

The VIN to VOUT voltage drop in the device is determined by the R_{ON} of the device and the load current. The R_{ON} of the device depends upon the VIN condition of the device. Refer to the R_{ON} specification of the device in the [Electrical Characteristics](#) table of this datasheet. Once the R_{ON} of the device is determined based upon the VIN conditions, use [Equation 1](#) to calculate the VIN to VOUT voltage drop:

$$\Delta V = I_{LOAD} \times R_{ON}$$

where

- ΔV = Voltage drop from VIN to VOUT
- I_{LOAD} = Load current
- R_{ON} = On-resistance of the device for a specific V_{IN}
- An appropriate I_{LOAD} must be chosen such that the I_{MAX} specification of the device is not violated. (1)

10.2.2.2 Managing Inrush Current

The output capacitors must be charged up from 0-V to V_{IN} when the switch is enabled. This charge arrives in the form of inrush current. Inrush current may be calculated using the following equation:

$$\text{Inrush Current} = C \times \frac{dv}{dt}$$

where

- C = Output capacitance
- $\frac{dv}{dt}$ = Output slew rate (2)

The TPS22920x offers a very slow controlled rise time for minimizing inrush current. This device can be selected based upon the maximum acceptable slew rate which can be calculated using the design requirements and the inrush current equation. An output capacitance of 4.7 μF will be used since the amount of inrush increases with output capacitance:

$$40\text{mA} = 4.7\mu\text{F} \times \frac{dv}{dt} \quad (3)$$

$$\frac{dv}{dt} = 8.5\text{V/ms} \quad (4)$$

A device with a slew rate less than 8.5 V/ms must be used to ensure an inrush current of less than 40 mA.

The TPS22920 has a typical rise time of 880 μs at 3.3 V. This results in a slew rate of 3.75 V/ms which meets the [Design Requirements](#).

10.2.3 Application Curves

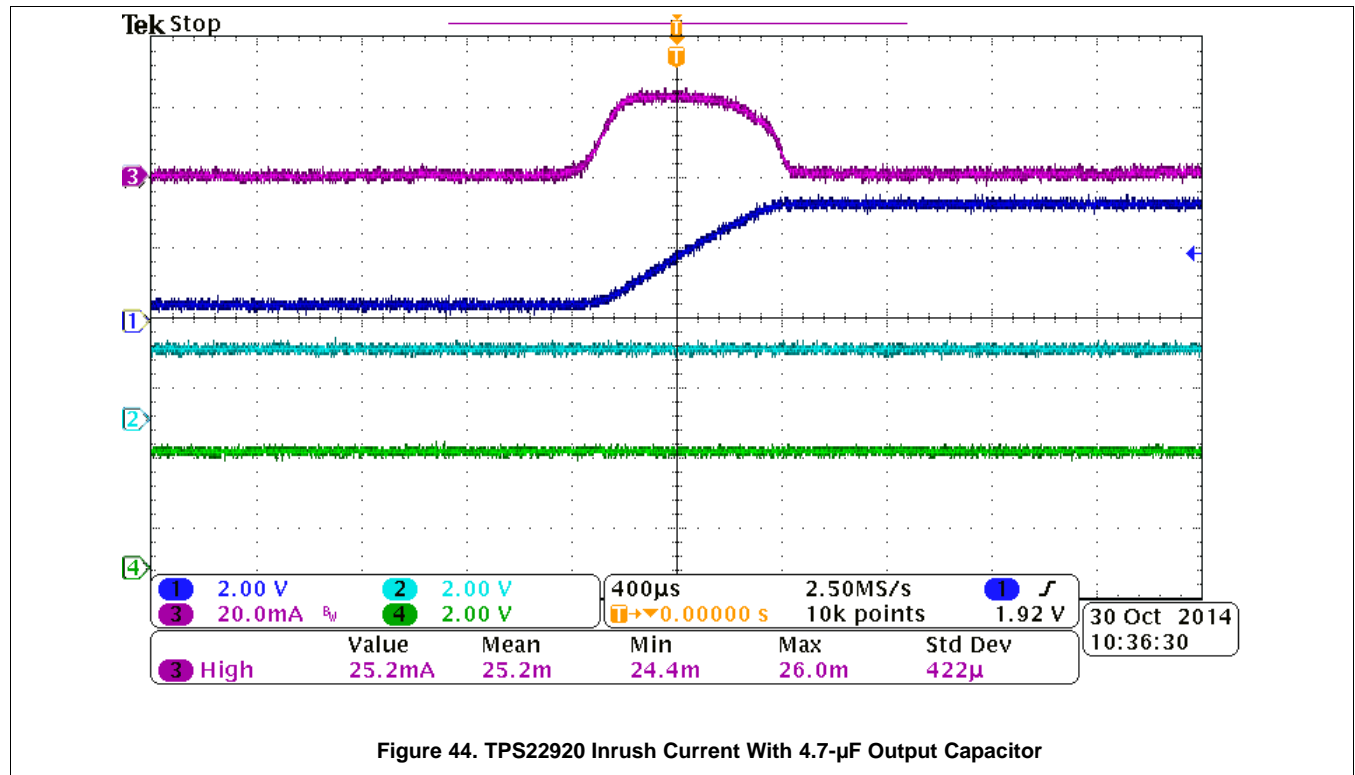

11 Power Supply Recommendations

The device is designed to operate from a V_{IN} range of 0.75 V to 3.6 V. The V_{IN} power supply must be well regulated and placed as close to the V_{IN} terminal as possible. The power supply must be able to withstand all transient load current steps. In most situations, using the minimum recommended input capacitance of 1 μF is sufficient to prevent the supply voltage from dipping when the switch is turned on. In cases where the power supply is slow to respond to a large transient current or large load current step, additional bulk capacitance may be required on the input.

12 Layout

12.1 Layout Guidelines

All traces should be as short as possible for best performance. The input and output capacitors must be placed close to the device to minimize the effects that parasitic trace inductances may have on normal operation. Using wide traces for V_{IN} , V_{OUT} , and GND helps minimize the parasitic electrical effects along with minimizing the case to ambient thermal impedance.

12.2 Layout Example

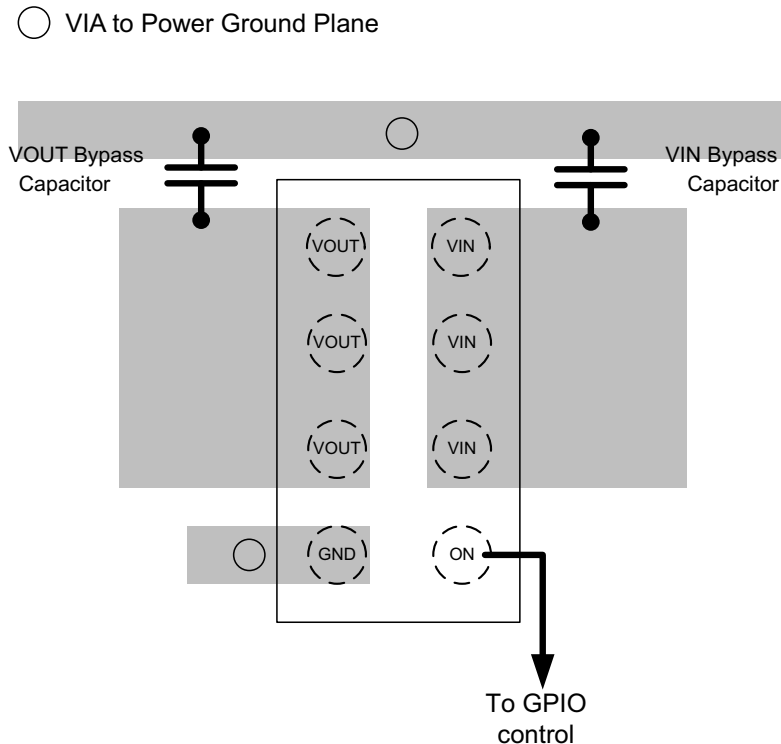

Figure 45. Package Layout Example

13 Device and Documentation Support

13.1 Related Links

The table below lists quick access links. Categories include technical documents, support and community resources, tools and software, and quick access to sample or buy.

Table 2. Related Links

PARTS	PRODUCT FOLDER	SAMPLE & BUY	TECHNICAL DOCUMENTS	TOOLS & SOFTWARE	SUPPORT & COMMUNITY
TPS22920	Click here	Click here	Click here	Click here	Click here
TPS22920L	Click here	Click here	Click here	Click here	Click here

13.2 Trademarks

All trademarks are the property of their respective owners.

13.3 Electrostatic Discharge Caution



These devices have limited built-in ESD protection. The leads should be shorted together or the device placed in conductive foam during storage or handling to prevent electrostatic damage to the MOS gates.

13.4 Glossary

[SLYZ022](#) — *TI Glossary*.

This glossary lists and explains terms, acronyms, and definitions.

14 Mechanical, Packaging, and Orderable Information

The following pages include mechanical, packaging, and orderable information. This information is the most current data available for the designated devices. This data is subject to change without notice and revision of this document. For browser-based versions of this data sheet, refer to the left-hand navigation.

PACKAGING INFORMATION

Orderable Device	Status (1)	Package Type	Package Drawing	Pins	Package Qty	Eco Plan (2)	Lead/Ball Finish (6)	MSL Peak Temp (3)	Op Temp (°C)	Device Marking (4/5)	Samples
TPS22920LYZPR	ACTIVE	DSBGA	YZP	8	3000	Green (RoHS & no Sb/Br)	SNAGCU	Level-1-260C-UNLIM	-40 to 85	DV	Samples
TPS22920LYZPT	ACTIVE	DSBGA	YZP	8	250	Green (RoHS & no Sb/Br)	SNAGCU	Level-1-260C-UNLIM	-40 to 85	DV	Samples
TPS22920YZPR	ACTIVE	DSBGA	YZP	8	3000	Green (RoHS & no Sb/Br)	SNAGCU	Level-1-260C-UNLIM	-40 to 85	6Z	Samples
TPS22920YZPRB	ACTIVE	DSBGA	YZP	8	3000	Green (RoHS & no Sb/Br)	SNAGCU	Level-1-260C-UNLIM	-40 to 85	6Z S	Samples
TPS22920YZPT	ACTIVE	DSBGA	YZP	8	250	Green (RoHS & no Sb/Br)	SNAGCU	Level-1-260C-UNLIM	-40 to 85	6Z	Samples

(1) The marketing status values are defined as follows:

ACTIVE: Product device recommended for new designs.

LIFEBUY: TI has announced that the device will be discontinued, and a lifetime-buy period is in effect.

NRND: Not recommended for new designs. Device is in production to support existing customers, but TI does not recommend using this part in a new design.

PREVIEW: Device has been announced but is not in production. Samples may or may not be available.

OBSOLETE: TI has discontinued the production of the device.

(2) Eco Plan - The planned eco-friendly classification: Pb-Free (RoHS), Pb-Free (RoHS Exempt), or Green (RoHS & no Sb/Br) - please check <http://www.ti.com/productcontent> for the latest availability information and additional product content details.

TBD: The Pb-Free/Green conversion plan has not been defined.

Pb-Free (RoHS): TI's terms "Lead-Free" or "Pb-Free" mean semiconductor products that are compatible with the current RoHS requirements for all 6 substances, including the requirement that lead not exceed 0.1% by weight in homogeneous materials. Where designed to be soldered at high temperatures, TI Pb-Free products are suitable for use in specified lead-free processes.

Pb-Free (RoHS Exempt): This component has a RoHS exemption for either 1) lead-based flip-chip solder bumps used between the die and package, or 2) lead-based die adhesive used between the die and leadframe. The component is otherwise considered Pb-Free (RoHS compatible) as defined above.

Green (RoHS & no Sb/Br): TI defines "Green" to mean Pb-Free (RoHS compatible), and free of Bromine (Br) and Antimony (Sb) based flame retardants (Br or Sb do not exceed 0.1% by weight in homogeneous material)

(3) MSL, Peak Temp. - The Moisture Sensitivity Level rating according to the JEDEC industry standard classifications, and peak solder temperature.

(4) There may be additional marking, which relates to the logo, the lot trace code information, or the environmental category on the device.

(5) Multiple Device Markings will be inside parentheses. Only one Device Marking contained in parentheses and separated by a "~" will appear on a device. If a line is indented then it is a continuation of the previous line and the two combined represent the entire Device Marking for that device.

⁽⁶⁾ Lead/Ball Finish - Orderable Devices may have multiple material finish options. Finish options are separated by a vertical ruled line. Lead/Ball Finish values may wrap to two lines if the finish value exceeds the maximum column width.

Important Information and Disclaimer:The information provided on this page represents TI's knowledge and belief as of the date that it is provided. TI bases its knowledge and belief on information provided by third parties, and makes no representation or warranty as to the accuracy of such information. Efforts are underway to better integrate information from third parties. TI has taken and continues to take reasonable steps to provide representative and accurate information but may not have conducted destructive testing or chemical analysis on incoming materials and chemicals. TI and TI suppliers consider certain information to be proprietary, and thus CAS numbers and other limited information may not be available for release.

In no event shall TI's liability arising out of such information exceed the total purchase price of the TI part(s) at issue in this document sold by TI to Customer on an annual basis.

TAPE AND REEL INFORMATION

QUADRANT ASSIGNMENTS FOR PIN 1 ORIENTATION IN TAPE

*All dimensions are nominal

Device	Package Type	Package Drawing	Pins	SPQ	Reel Diameter (mm)	Reel Width W1 (mm)	A0 (mm)	B0 (mm)	K0 (mm)	P1 (mm)	W (mm)	Pin1 Quadrant
TPS22920LYZPR	DSBGA	YZP	8	3000	180.0	8.4	1.02	2.02	0.63	4.0	8.0	Q1
TPS22920LYZPT	DSBGA	YZP	8	250	180.0	8.4	1.02	2.02	0.63	4.0	8.0	Q1
TPS22920YZPR	DSBGA	YZP	8	3000	180.0	8.4	1.02	2.02	0.63	4.0	8.0	Q1
TPS22920YZPRB	DSBGA	YZP	8	3000	180.0	8.4	1.02	2.02	0.63	4.0	8.0	Q1
TPS22920YZPT	DSBGA	YZP	8	250	180.0	8.4	1.02	2.02	0.63	4.0	8.0	Q1

TAPE AND REEL BOX DIMENSIONS

*All dimensions are nominal

Device	Package Type	Package Drawing	Pins	SPQ	Length (mm)	Width (mm)	Height (mm)
TPS22920LYZPR	DSBGA	YZP	8	3000	182.0	182.0	20.0
TPS22920LYZPT	DSBGA	YZP	8	250	182.0	182.0	20.0
TPS22920YZPR	DSBGA	YZP	8	3000	182.0	182.0	20.0
TPS22920YZPRB	DSBGA	YZP	8	3000	182.0	182.0	20.0
TPS22920YZPT	DSBGA	YZP	8	250	182.0	182.0	20.0

YZP0008

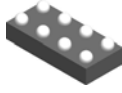

PACKAGE OUTLINE

DSBGA - 0.5 mm max height

DIE SIZE BALL GRID ARRAY

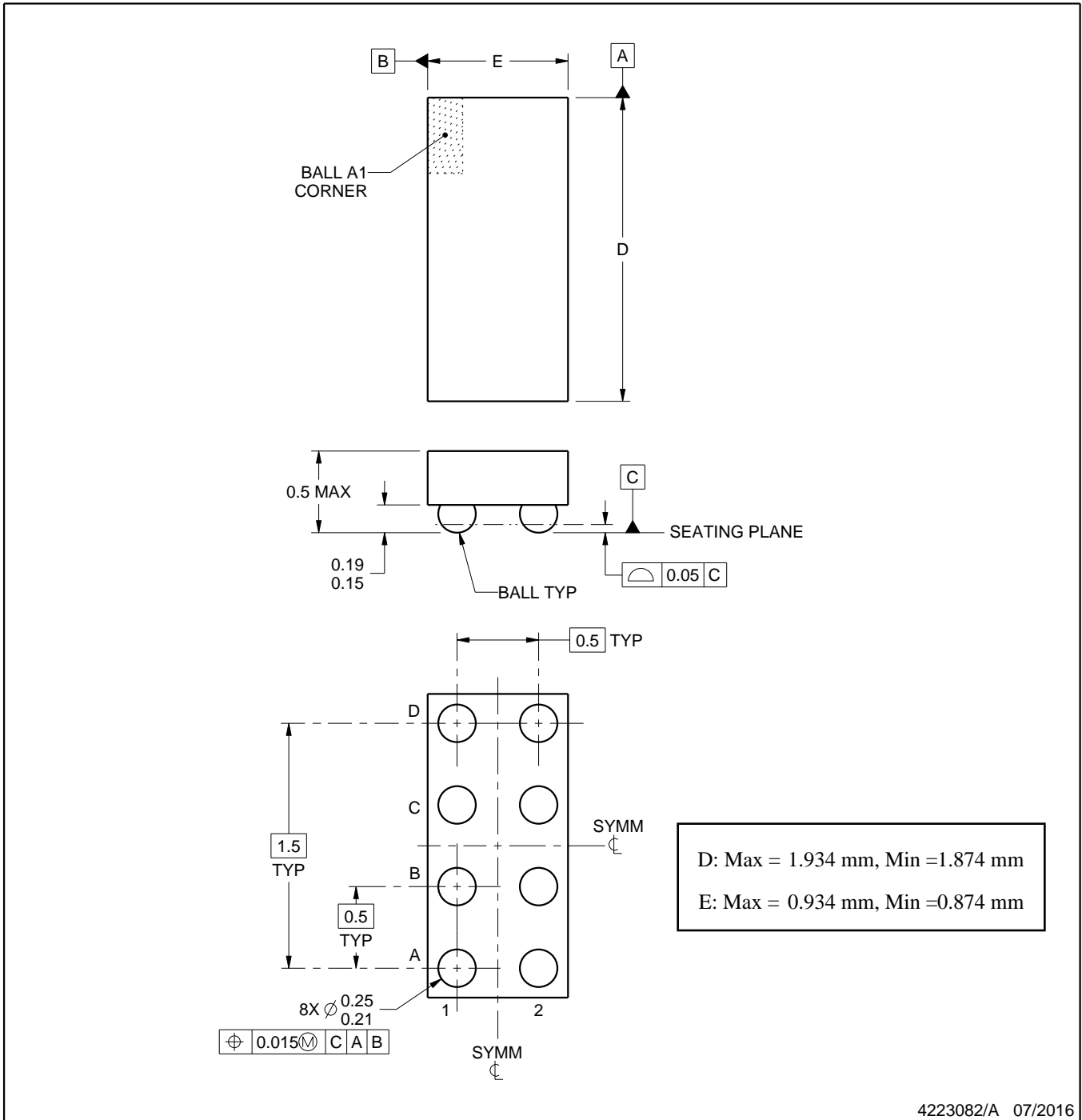

4223082/A 07/2016

NOTES:

1. All linear dimensions are in millimeters. Any dimensions in parenthesis are for reference only. Dimensioning and tolerancing per ASME Y14.5M.
2. This drawing is subject to change without notice.

EXAMPLE BOARD LAYOUT

YZP0008

DSBGA - 0.5 mm max height

DIE SIZE BALL GRID ARRAY

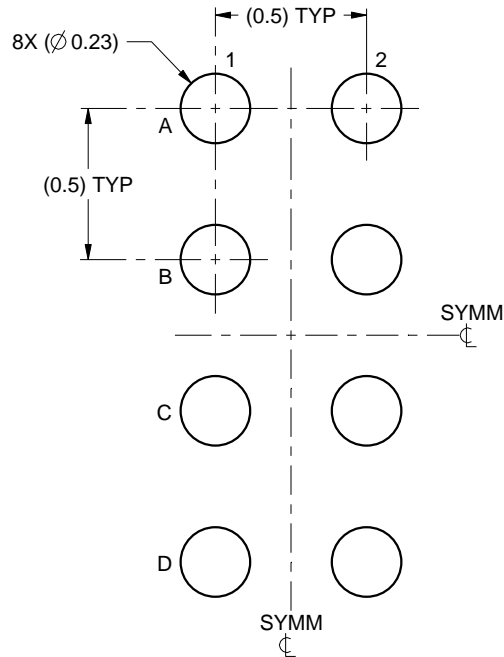

LAND PATTERN EXAMPLE
SCALE:40X

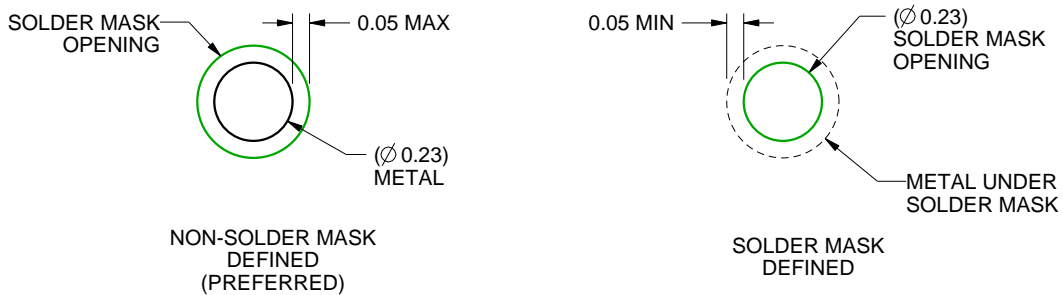

SOLDER MASK DETAILS
NOT TO SCALE

4223082/A 07/2016

NOTES: (continued)

- Final dimensions may vary due to manufacturing tolerance considerations and also routing constraints. For more information, see Texas Instruments literature number SNVA009 (www.ti.com/lit/snva009).

EXAMPLE STENCIL DESIGN

YZP0008

DSBGA - 0.5 mm max height

DIE SIZE BALL GRID ARRAY

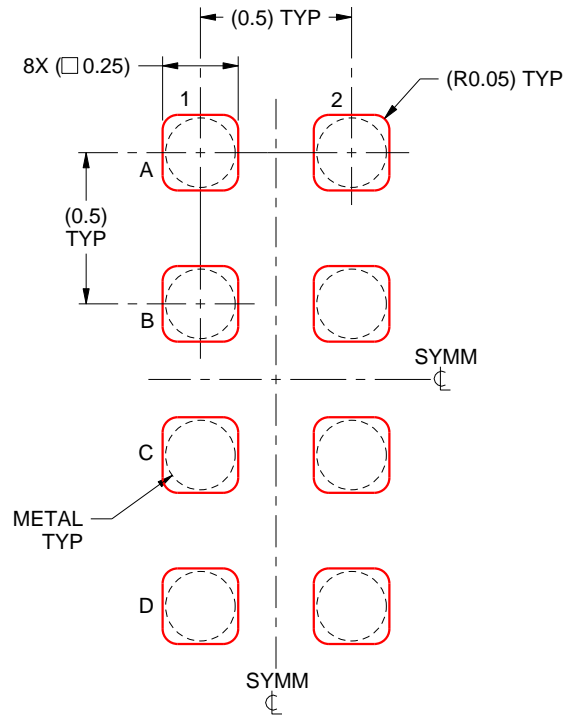

SOLDER PASTE EXAMPLE
BASED ON 0.1 mm THICK STENCIL
SCALE:40X

4223082/A 07/2016

NOTES: (continued)

4. Laser cutting apertures with trapezoidal walls and rounded corners may offer better paste release.

IMPORTANT NOTICE AND DISCLAIMER

TI PROVIDES TECHNICAL AND RELIABILITY DATA (INCLUDING DATASHEETS), DESIGN RESOURCES (INCLUDING REFERENCE DESIGNS), APPLICATION OR OTHER DESIGN ADVICE, WEB TOOLS, SAFETY INFORMATION, AND OTHER RESOURCES "AS IS" AND WITH ALL FAULTS, AND DISCLAIMS ALL WARRANTIES, EXPRESS AND IMPLIED, INCLUDING WITHOUT LIMITATION ANY IMPLIED WARRANTIES OF MERCHANTABILITY, FITNESS FOR A PARTICULAR PURPOSE OR NON-INFRINGEMENT OF THIRD PARTY INTELLECTUAL PROPERTY RIGHTS.

These resources are intended for skilled developers designing with TI products. You are solely responsible for (1) selecting the appropriate TI products for your application, (2) designing, validating and testing your application, and (3) ensuring your application meets applicable standards, and any other safety, security, or other requirements. These resources are subject to change without notice. TI grants you permission to use these resources only for development of an application that uses the TI products described in the resource. Other reproduction and display of these resources is prohibited. No license is granted to any other TI intellectual property right or to any third party intellectual property right. TI disclaims responsibility for, and you will fully indemnify TI and its representatives against, any claims, damages, costs, losses, and liabilities arising out of your use of these resources.

TI's products are provided subject to TI's Terms of Sale (www.ti.com/legal/termsofsale.html) or other applicable terms available either on ti.com or provided in conjunction with such TI products. TI's provision of these resources does not expand or otherwise alter TI's applicable warranties or warranty disclaimers for TI products.

Mailing Address: Texas Instruments, Post Office Box 655303, Dallas, Texas 75265
Copyright © 2019, Texas Instruments Incorporated

Looking for pricing, stock, or lifecycle information?

Click below to explore more details on WIN SOURCE:

 [View TPS22920YZPT on WIN SOURCE](#)

 [Texas Instruments](#) Information

Optimize Your Supply Chain with WIN SOURCE Solutions

-  Global Sourcing Solution
-  Obsolete Management
-  Cost Control Management
-  Shortage Management
-  Alternative Solution
-  Excess Inventory Management