



**THE DATASHEET OF  
AH5771-PG-B**



### Features

- Support single-phase full wave min fan driver
- Built-in Hall sensor input amplifier
- Low voltage startup (  $V_{dd}=2.5V$  )
- Lock detection and automatic self-restart
- Without external timing capacitor, Reduces the numbers of external component required
- Low profile package : SIP-4L
- SIP-4L: Available in "Green" Molding Compound (No Br, Sb)
- Lead Free Finish / RoHS Compliant (Note 1)

### General Description

AH5771 is the integrated Hall sensor with output drivers designed for electrical commutation of brush-less DC motor application. The device is as follows: one-chip Hall voltage generator for magnetic sensing; the error amplifier that amplifies the Hall voltage; a comparator is to provide switching hysteresis for noise rejection; the full bridge driver for sinking and driving current load. Internal band gap regulator is used to provide temperature compensated bias for internal circuits and allows a wide operating supply voltage range. The device includes features such as Rotor Lock Protection with rotor lock detection and automatic self-restart to avoid damage to the coil when the rotor is blocked. AH5771 is rated for operation over-temperature range from  $-40^{\circ}\text{C}$  to  $100^{\circ}\text{C}$  and voltage range from 2.5V to 15V. The device is available in low profile package SIP-4L.

### Typical Application Circuit

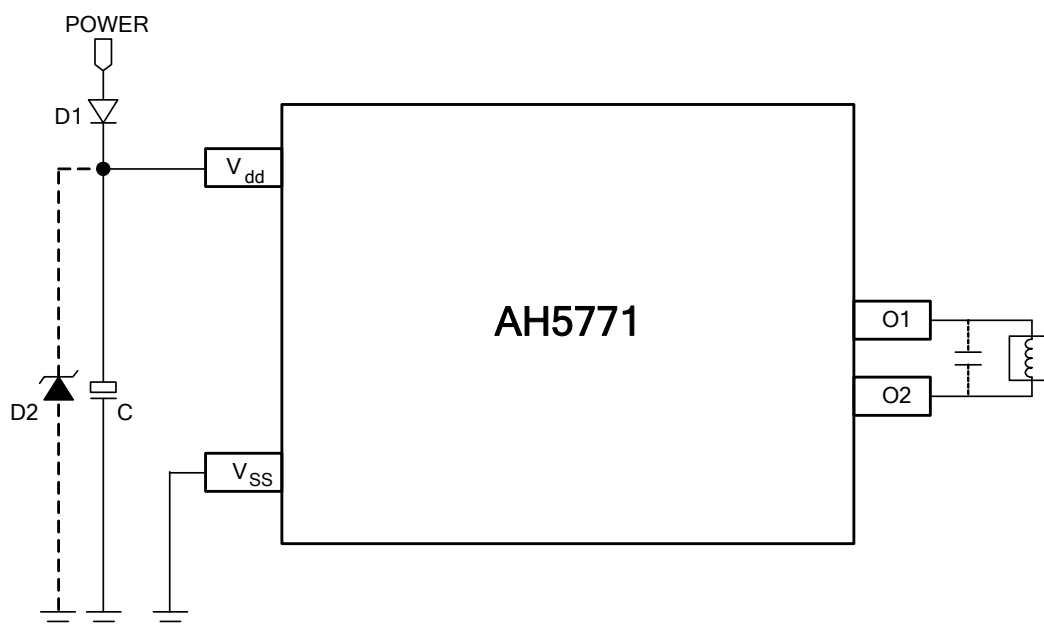

Note: D2 (Zener Diode) and Capacitor C are for power stabilization, D2 is recommended to be 18Vz (option), C is recommended to 0.1uF ~1uF (E-Cap). D1 (reverse Diode) is for reverse voltage protection.

### Ordering Information

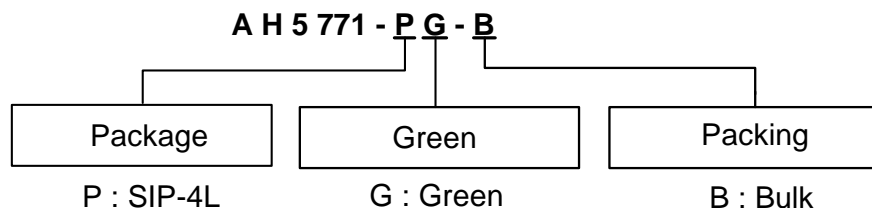

Device	Package Code	Packaging (Note 2)	Bulk	
			Quantity	Part Number Suffix
 AH5771-PG-B	P	SIP-4L	1000	-B

Notes: 1. EU Directive 2002/95/EC (RoHS). All applicable RoHS exemptions applied. Please visit our website at [http://www.diodes.com/products/lead\\_free.html](http://www.diodes.com/products/lead_free.html)  
 2. Pad layout as shown on Diodes Inc. suggested pad layout document AP02001, which can be found on our website at <http://www.diodes.com/datasheets/ap02001.pdf>.

### Pin Assignment

( Top View )

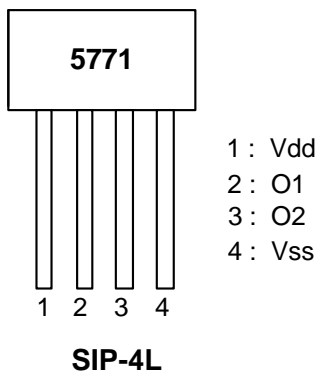

### Pin Description

Pin Name	Pin No.	Description
Vdd	1	Power supply pin
O1	2	Output driving & sinking pin
O2	3	Output driving & sinking Pin
V <sub>SS</sub>	4	Ground pin

### Block Diagram

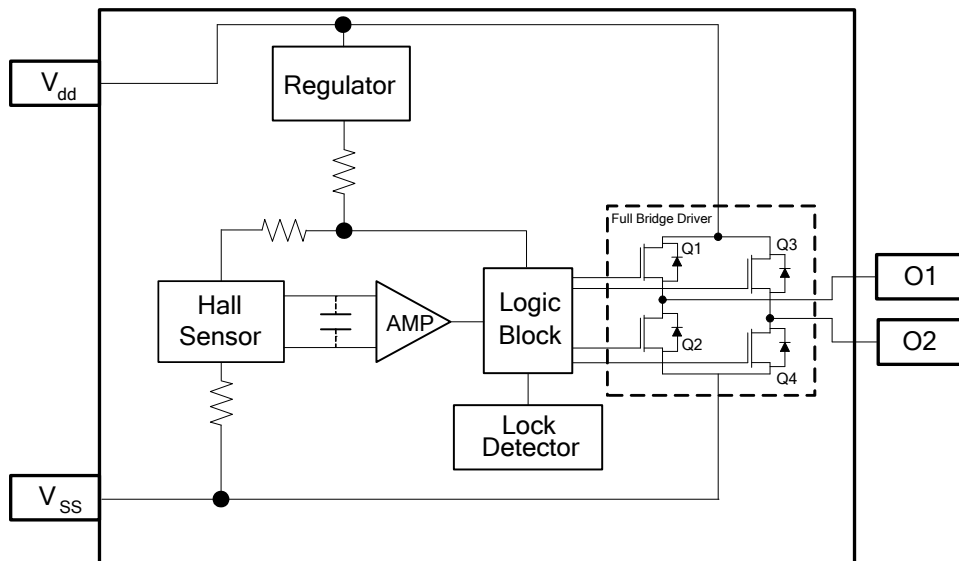

### Absolute Maximum Ratings (Unless otherwise noted, at TA= 25°C)

Symbol	Characteristics	Values	Unit
V <sub>dd</sub>	Supply voltage	18	V
I <sub>o</sub> (peak as hold)	Output Current (Peak as hold)	400	mA
P <sub>D</sub>	Power Dissipation	SIP-4L	550
T <sub>ST</sub>	Storage Temperature Range	-55 ~ 150	°C

### Recommended Operating Conditions

Symbol	Characteristics	Conditions	Ratings	Unit
V <sub>dd</sub>	Supply voltage	Operating	2.5~15	V
T <sub>A</sub>	Operating Temperature Range	Operating	-40 to +100	°C

### Electrical Characteristics (TA = 25°C, V<sub>dd</sub> = 12V; unless otherwise specified)

Symbol	Characteristics	Conditions	Min	Typ.	Max	Unit
I <sub>dd</sub>	Supply Current	No Load	-	3.5	5	mA
V <sub>OH</sub>	Output Voltage High	I <sub>OUT</sub> = 200mA	11.4	-	-	V
V <sub>OL</sub>	Output Voltage Low	I <sub>OUT</sub> = 200mA	-	-	0.6	V
T <sub>ON</sub>	On Time	V <sub>dd</sub> = 12V	-	220	-	ms
R <sub>DR</sub>	Duty Ratio	T <sub>OFF</sub> / T <sub>ON</sub>	-	10	-	

### Magnetic Characteristics (TA=25°C, Vdd=2.5V~15V)

(1mT = 10 G)

Symbol	Characteristic	Min	Typ.	Max	Unit
B <sub>Op</sub>	Operate Point	-10	30	50	G
Brp	Release Point	-50	-30	-10	G
B <sub>hy</sub>	Hysteresis	-	60	-	G

### Performance Characteristics

T <sub>A</sub> (°C)	25	50	60	70	80	85	90	95	100
P <sub>D</sub> (mW)	550	440	396	352	308	286	264	242	220
T <sub>A</sub> (°C)	105	110	115	120	125	130	135	140	150
P <sub>D</sub> (mW)	198	176	154	132	110	88	66	44	0

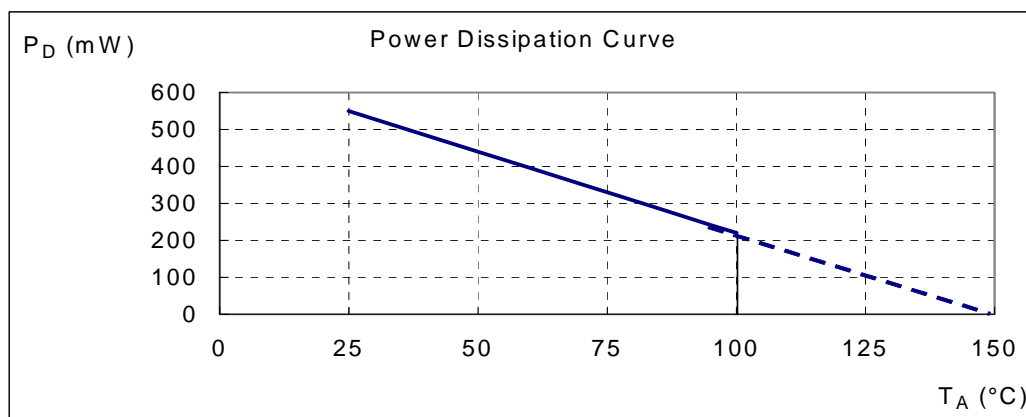

### Marking Information

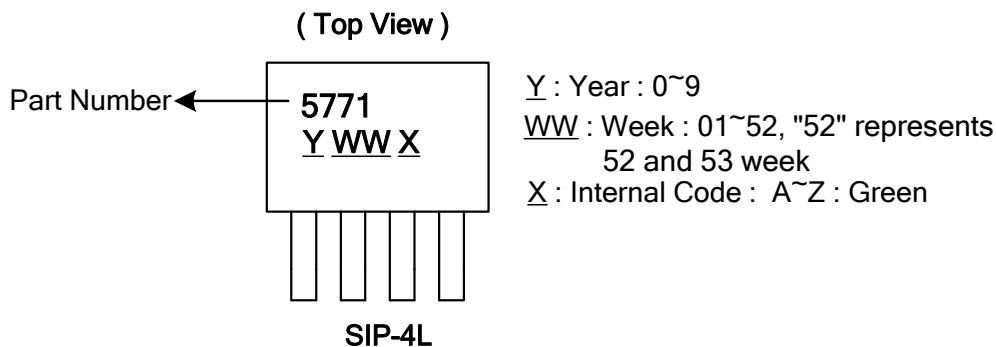

**Package Information** (All Dimensions in mm)

(1) Package type: SIP-4L

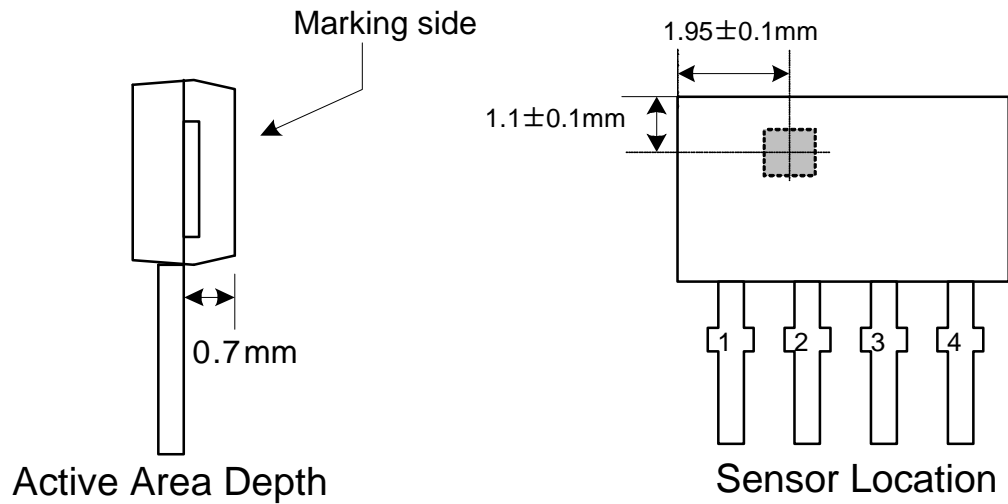

**Package Dimension**

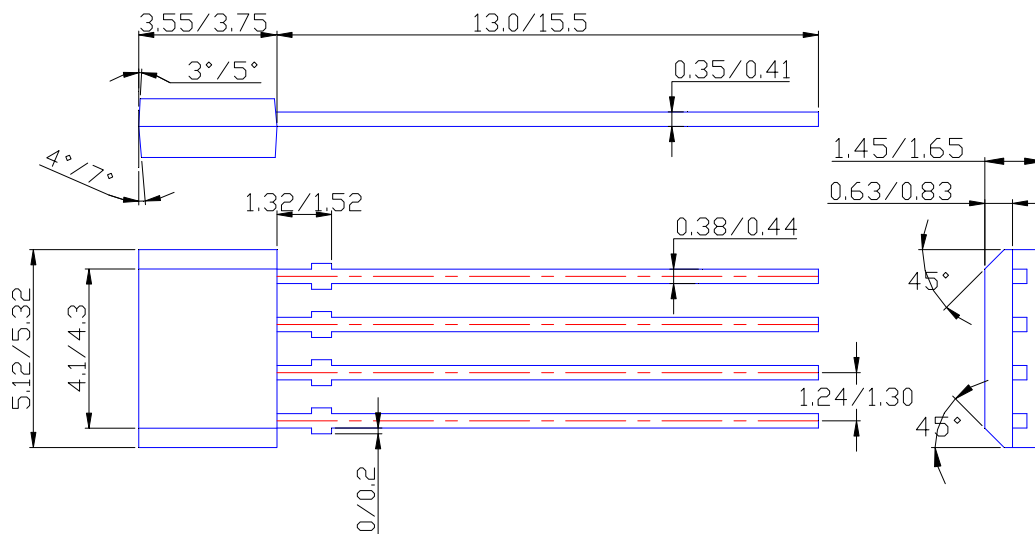

**SINGLE PHASE HALL EFFECT LATCH SMART FAN  
MOTOR CONTROLLER****IMPORTANT NOTICE**

DIODES INCORPORATED MAKES NO WARRANTY OF ANY KIND, EXPRESS OR IMPLIED, WITH REGARDS TO THIS DOCUMENT, INCLUDING, BUT NOT LIMITED TO, THE IMPLIED WARRANTIES OF MERCHANTABILITY AND FITNESS FOR A PARTICULAR PURPOSE (AND THEIR EQUIVALENTS UNDER THE LAWS OF ANY JURISDICTION).

Diodes Incorporated and its subsidiaries reserve the right to make modifications, enhancements, improvements, corrections or other changes without further notice to this document and any product described herein. Diodes Incorporated does not assume any liability arising out of the application or use of this document or any product described herein; neither does Diodes Incorporated convey any license under its patent or trademark rights, nor the rights of others. Any Customer or user of this document or products described herein in such applications shall assume all risks of such use and will agree to hold Diodes Incorporated and all the companies whose products are represented on Diodes Incorporated website, harmless against all damages.

Diodes Incorporated does not warrant or accept any liability whatsoever in respect of any products purchased through unauthorized sales channel.

Should Customers purchase or use Diodes Incorporated products for any unintended or unauthorized application, Customers shall indemnify and hold Diodes Incorporated and its representatives harmless against all claims, damages, expenses, and attorney fees arising out of, directly or indirectly, any claim of personal injury or death associated with such unintended or unauthorized application.

Products described herein may be covered by one or more United States, international or foreign patents pending. Product names and markings noted herein may also be covered by one or more United States, international or foreign trademarks.

**LIFE SUPPORT**

Diodes Incorporated products are specifically not authorized for use as critical components in life support devices or systems without the express written approval of the Chief Executive Officer of Diodes Incorporated. As used herein:

- A. Life support devices or systems are devices or systems which:
1. are intended to implant into the body, or
  2. support or sustain life and whose failure to perform when properly used in accordance with instructions for use provided in the labeling can be reasonably expected to result in significant injury to the user.
- B. A critical component is any component in a life support device or system whose failure to perform can be reasonably expected to cause the failure of the life support device or to affect its safety or effectiveness.

Customers represent that they have all necessary expertise in the safety and regulatory ramifications of their life support devices or systems, and acknowledge and agree that they are solely responsible for all legal, regulatory and safety-related requirements concerning their products and any use of Diodes Incorporated products in such safety-critical, life support devices or systems, notwithstanding any devices- or systems-related information or support that may be provided by Diodes Incorporated. Further, Customers must fully indemnify Diodes Incorporated and its representatives against any damages arising out of the use of Diodes Incorporated products in such safety-critical, life support devices or systems.

Copyright © 2009, Diodes Incorporated

[www.diodes.com](http://www.diodes.com)

## Looking for pricing, stock, or lifecycle information?

Click below to explore more details on WIN SOURCE:

- ⊖ [View AH5771-PG-B on WIN SOURCE](#)
- ⊖ [Diodes Incorporated Information](#)

## Optimize Your Supply Chain with WIN SOURCE Solutions

- ✓ Global Sourcing Solution
- ✓ Obsolete Management
- ✓ Cost Control Management
- ✓ Shortage Management
- ✓ Alternative Solution
- ✓ Excess Inventory Management