

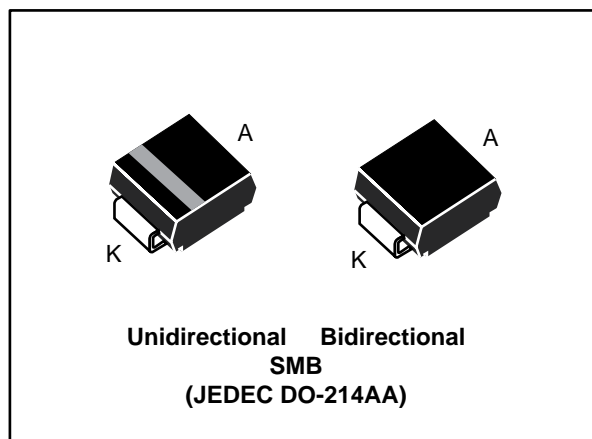

**THE DATASHEET OF  
SMBJ58CA-TR**





## Description

The SMBJ Transil series has been designed to protect sensitive equipment against electrostatic discharges according to IEC 61000-4-2, and MIL STD 883, method 3015, and electrical over stress according to IEC 61000-4-4 and 5. These devices are more generally used against surges below 600 W (10/1000  $\mu$ s).

Planar technology makes these devices suitable for high-end equipment and SMPS where low leakage current and high junction temperature are required to provide reliability and stability over time.

SMBJ are packaged in SMB (SMB footprint in accordance with IPC 7531 standard).

Transil™ is a trademark of STMicroelectronics.

## Features

- Peak pulse power:
  - 600 W (10/1000  $\mu$ s)
  - 4 kW (8/20  $\mu$ s)
- Stand-off voltage range: from 5 V to 188 V
- Unidirectional and bidirectional types
- Low leakage current:
  - 0.2  $\mu$ A at 25 °C
  - 1  $\mu$ A at 85 °C
- Operating  $T_j$  max: 150 °C
- High power capability at  $T_j$  max:
  - 515 W (10/1000  $\mu$ s)
- JEDEC registered package outline

## Complies with the following standards

- IEC 61000-4-2 level 4:
  - 15 kV (air discharge)
  - 8 kV (contact discharge)
- IEC 61000-4-5
- MIL STD 883G, method 3015-7: class 3B:
  - 25 kV HBM (human body model)
- Resin meets UL 94, V0
- MIL-STD-750, method 2026 solderability
- EIA STD RS-481 and IEC 60286-3 packing
- IPC 7531 footprint

# 1 Characteristics

Table 1: Absolute maximum ratings ( $T_{amb} = 25\text{ }^{\circ}\text{C}$ )

Symbol	Parameter	Value	Unit
$P_{PP}$	Peak pulse power dissipation	$T_j \text{ initial} = T_{amb}$	600 W
$T_j$	Operating junction temperature range	-55 to +150	$^{\circ}\text{C}$
$T_{stg}$	Storage temperature range	-65 to +150	$^{\circ}\text{C}$
$T_L$	Maximum lead temperature for soldering during 10 s	260	$^{\circ}\text{C}$

Table 2: Thermal resistance

Symbol	Parameter	Value	Unit
$R_{th(j-l)}$	Junction to leads	20	$^{\circ}\text{C/W}$
$R_{th(j-a)}$	Junction to ambient on printed circuit on recommended pad layout	100	$^{\circ}\text{C/W}$

Figure 1: Electrical characteristics - parameter definitions

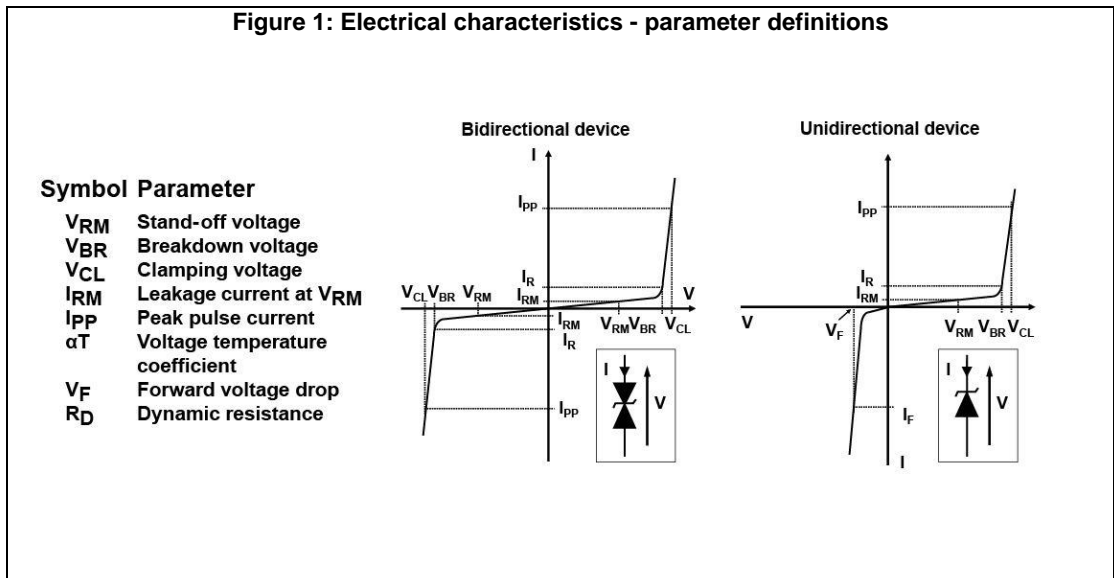

Figure 2: Pulse definition for electrical characteristics

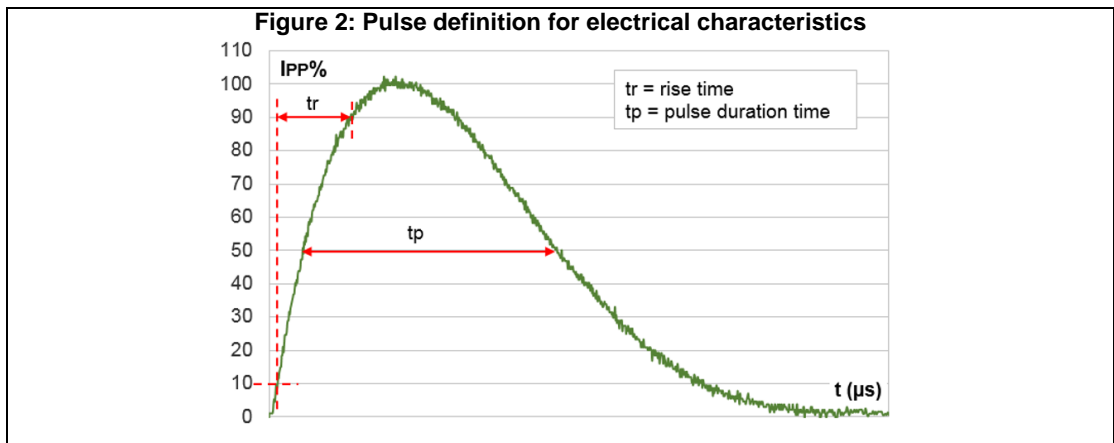

Table 3: Electrical characteristics parameter values ( $T_{amb} = 25\text{ }^{\circ}\text{C}$ , unless otherwise specified)

Order code	$I_{RM}$ max at $V_{RM}$		$V_{BR}$ at $I_R^{(1)}$				10 / 1000 $\mu\text{s}$			8 / 20 $\mu\text{s}$			$\alpha T^{(2)}$
							$V_{CL}$	$I_{PP}$	$R_D$	$V_{CL}$	$I_{PP}$	$R_D$	
	25 $^{\circ}\text{C}$	85 $^{\circ}\text{C}$		Min.	Typ.		Max.		Max.	Max.			Max.
	$\mu\text{A}$		V	V		mA	V <sup>(3)</sup>	A <sup>(4)</sup>	$\Omega$	V	A	$\Omega$	$10^{-4}/^{\circ}\text{C}$
SMBJ5.A/CA	20	50	5.0	6.40	6.74	10	9.2	68	0.031	14.4	275	0.027	5.7
SMBJ6.0A/CA	20	50	6.0	6.70	7.05	10	10.3	61	0.048	14.8	270	0.027	5.9
SMBJ6.5A/CA	20	50	6.5	7.20	7.58	10	11.2	56	0.058	15.2	266	0.027	6.1
SMBJ8.5A/CA	20	50	8.5	9.40	9.90	1	14.4	41.7	0.096	19.5	205	0.044	7.3
SMBJ10A/CA	0.2	1	10	11.1	11.7	1	17	37	0.127	21.7	184	0.051	7.8
SMBJ12A/CA	0.2	1	12	13.3	14.0	1	19.9	31	0.168	25.3	157	0.068	8.3
SMBJ13A/CA	0.2	1	13	14.4	15.2	1	21.5	29	0.191	27.2	147	0.076	8.4
SMBJ15A/CA	0.2	1	15	16.7	17.6	1	24.4	25.1	0.236	32.5	123	0.114	8.8
SMBJ16A/CA	0.2	1	16	17.8	18.7	1	26	23.1	0.276	34.4	116	0.127	8.8
SMBJ18A/CA	0.2	1	18	20.0	21.1	1	29.2	21.5	0.328	39.3	102	0.168	9.2
SMBJ20A/CA	0.2	1	20	22.2	23.4	1	32.4	19.4	0.404	42.8	93	0.196	9.4
SMBJ22A/CA	0.2	1	22	24.4	25.7	1	35.5	17.7	0.481	48.3	83	0.257	9.6
SMBJ24A/CA	0.2	1	24	26.7	28.1	1	38.9	16	0.587	50	80	0.256	9.6
SMBJ26A/CA	0.2	1	26	28.9	30.4	1	42.1	14.9	0.683	53.5	75	0.288	9.7
SMBJ28A/CA	0.2	1	28	31.1	32.7	1	45.4	13.8	0.802	59	68	0.363	9.8
SMBJ30A/CA	0.2	1	30	33.3	35.1	1	48.4	13	0.888	64.3	62	0.443	9.9
SMBJ33A/CA	0.2	1	33	36.7	38.6	1	53.3	11.8	1.08	69.7	57	0.512	10.0
SMBJ36A/CA	0.2	1	36	40.0	42.1	1	58.1	10.3	1.35	76	52	0.611	10.0
SMBJ40A/CA	0.2	1	40	44.4	46.7	1	64.5	9.7	1.59	84	48	0.728	10.1
SMBJ48A/CA	0.2	1	48	53.3	56.1	1	77.4	8.1	2.28	100	40	1.03	10.3
SMBJ58A/CA	0.2	1	58	64.4	67.8	1	93.6	6.7	3.34	121	33	1.51	10.4
SMBJ70A/CA	0.2	1	70	77.8	81.9	1	113	5.5	4.91	146	27	2.22	10.5
SMBJ85A/CA	0.2	1	85	94	99	1	137	4.6	7.18	178	22.5	3.29	10.6
SMBJ100A/CA	0.2	1	100	111	117	1	162	3.8	10.3	212	19	4.69	10.7
SMBJ130A/CA	0.2	1	130	144	152	1	209	3	16.5	265	15	7.03	10.8
SMBJ154A/CA	0.2	1	154	171	180	1	246	2.4	23.8	317	12.6	10.2	10.8
SMBJ170A/CA	0.2	1	170	189	199	1	275	2.2	30.0	353	11.3	12.7	10.8
SMBJ188A/CA	0.2	1	188	209	220	1	328	2	48.5	388	10.3	15.2	10.8

**Notes:**(1)Pulse test:  $t_p < 50\text{ ms}$ (2)To calculate  $V_{BR}$  or  $V_{CL}$  versus junction temperature, use the following formulas:

- $V_{BR}$  at  $T_J = V_{BR}$  at  $25\text{ }^{\circ}\text{C} \times (1 + \alpha T \times (T_J - 25))$   
 $V_{CL}$  at  $T_J = V_{CL}$  at  $25\text{ }^{\circ}\text{C} \times (1 + \alpha T \times (T_J - 25))$

(3)To calculate maximum clamping voltage at other surge level, use the following formula:

- $V_{CLmax} = V_{BRmax} + R_D \times I_{PPappli}$  where  $I_{PPappli}$  is the surge current in the application

<sup>(4)</sup>Surge capability given for both directions for unidirectional and bidirectional types.

### 1.1 Characteristics (curves)



**Figure 6: Junction capacitance versus reverse applied voltage (typical values) (SMBJxxA)**

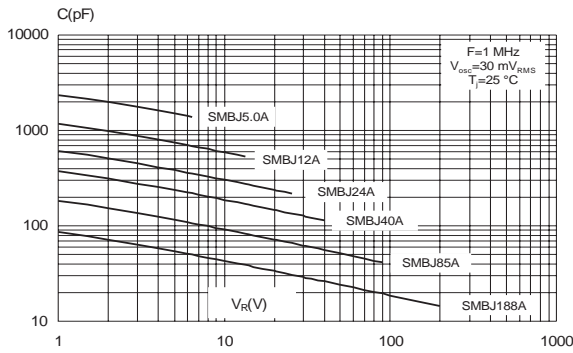

**Figure 7: Junction capacitance versus reverse applied voltage (typical values) (SMBJxxCA)**



**Figure 8: Peak forward voltage drop versus peak forward current (typical values)**

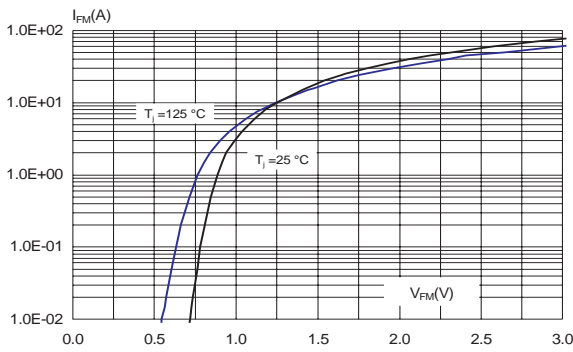

**Figure 9: Relative variation of thermal impedance junction to ambient versus pulse duration**

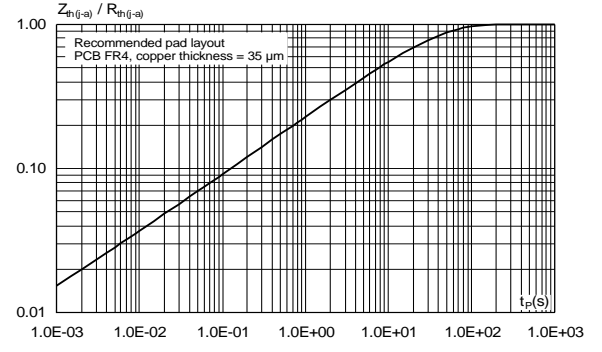

**Figure 10: Thermal resistance junction to ambient versus copper surface under each lead (printed circuit board FR4, eCu = 35 μm)**

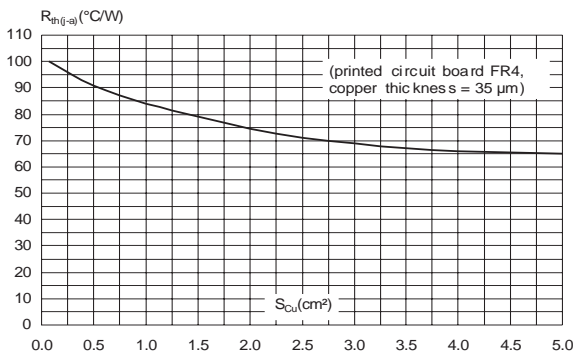

**Figure 11: Leakage current versus junction temperature (typical values)**



## 2 Package information

In order to meet environmental requirements, ST offers these devices in different grades of ECOPACK® packages, depending on their level of environmental compliance. ECOPACK® specifications, grade definitions and product status are available at: [www.st.com](http://www.st.com). ECOPACK® is an ST trademark.

- Case: JEDEC DO214-AA molded plastic over planar junction
- Terminals: solder plated, solderable per MIL-STD-750, method 2026
- Polarity: for unidirectional types the band indicates cathode.
- Flammability: epoxy is rated UL94V-0
- RoHS package

### 2.1 SMB package information

Figure 12: SMB package outline



Table 4: SMB package mechanical data

Ref.	Dimensions			
	Millimeters		Inches	
	Min.	Max.	Min.	Max.
A1	1.90	2.45	0.0748	0.0965
A2	0.05	0.20	0.0020	0.0079
b	1.95	2.20	0.0768	0.0867
c	0.15	0.40	0.0059	0.0157
D	3.30	3.95	0.1299	0.1556
E	5.10	5.60	0.2008	0.2205
E1	4.05	4.60	0.1594	0.1811
L	0.75	1.50	0.0295	0.0591

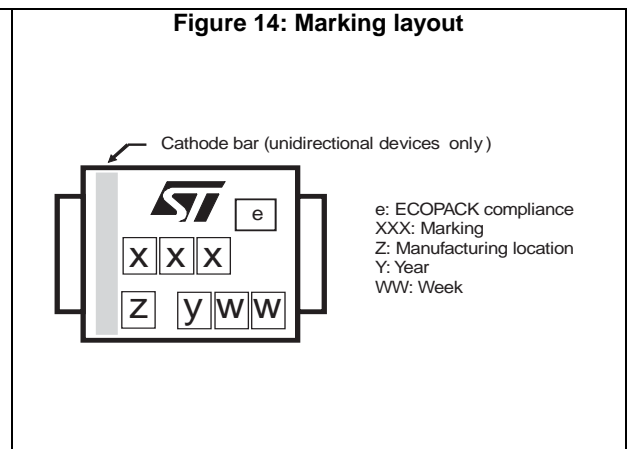
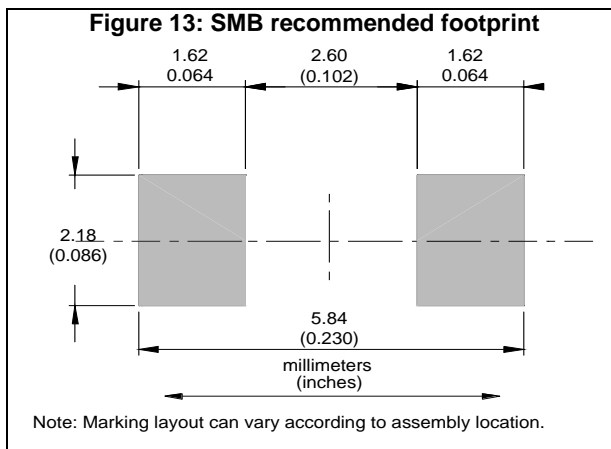

### 3 Ordering information

Figure 15: Ordering information scheme



Table 5: Ordering information

Order code <sup>(1)</sup>	Marking	Package	Weight	Base qty.	Delivery mode
SMBJxxxA/CA-TR <sup>(2)</sup>	See <a href="#">Table 6: "Marking"</a> .	SMB	0.11 g	2500	Tape and reel

**Notes:**

<sup>(1)</sup>xx indicates stand-off voltage

<sup>(2)</sup>Where xxx is nominal value of VBR and A or CA indicates unidirectional or bidirectional version. See [Table 3: "Electrical characteristics parameter values \(Tamb = 25 °C, unless otherwise specified\)"](#) for list of available devices and their order codes

Table 6: Marking

Order code	Marking	Order code	Marking
SMBJ5.0A	BUZ	SMBJ5.0CA	BBZ
SMBJ6.0A	BUA	SMBJ6.0CA	BBA
SMBJ6.5A	BUB	SMBJ6.5CA	BBB
SMBJ8.5A	BUC	SMBJ8.5CA	BBC
SMBJ10A	BUD	SMBJ10CA	BBD
SMBJ12A	BUE	SMBJ12CA	BBE
SMBJ13A	BUF	SMBJ13CA	BBF
SMBJ15A	BUG	SMBJ15CA	BBG
SMBJ16A	CUG	SMBJ16CA	CBG
SMBJ18A	BUH	SMBJ18CA	BBH
SMBJ20A	BUI	SMBJ20CA	BBI
SMBJ22A	BVA	SMBJ22CA	CBH
SMBJ24A	BUJ	SMBJ24CA	BBJ
SMBJ26A	BUK	SMBJ26CA	BBK
SMBJ28A	BUL	SMBJ28CA	BBL
SMBJ30A	BUM	SMBJ30CA	BBM
SMBJ33A	BUN	SMBJ33CA	BBN
SMBJ36A	CUN	SMBJ36CA	CBN
SMBJ40A	CUJ	SMBJ40CA	CBJ
SMBJ43A	CUW	SMBJ43CA	CBW
SMBJ48A	BUW	SMBJ48CA	BBW
SMBJ58A	BUO	SMBJ58CA	BBO
SMBJ70A	CUM	SMBJ70CA	CBM
SMBJ85A	BUQ	SMBJ85CA	BBQ
SMBJ100A	CUQ	SMBJ100CA	CBQ
SMBJ130A	BUS	SMBJ130A	BBS
SMBJ154A	BUT	SMBJ154A	BBT
SMBJ170A	BUU	SMBJ170A	BBU
SMBJ188A	BUV	SMBJ188A	BBV

## 4 Revision history

**Table 7: Document revision history**

Date	Revision	Changes
Oct-2001	4	Previous issue.
10-Feb-2005	5	Reformatted to current template. Added directional (uni and bi) indications to graphics. Added ECOPACK statement.
16-Nov-2006	6	Add part numbers SMBJ36A-TR and SMBJ36CA-TR in Table 3.
14-May-2009	7	Reformatted to current standards. Updated ECOPACK statement. Added part number SMBJ43CA/A.
17-Sep-2009	8	Document updated for low leakage current.
09-Jul-2010	9	Changed timescale in Figure 9.
20-Oct-2010	10	Updated Figure 13.
24-Jan-2018	11	Updated <a href="#">Table 3: "Electrical characteristics parameter values (<math>T_{amb} = 25\text{ }^{\circ}\text{C}</math>, unless otherwise specified)"</a> .

**IMPORTANT NOTICE – PLEASE READ CAREFULLY**

STMicroelectronics NV and its subsidiaries ("ST") reserve the right to make changes, corrections, enhancements, modifications, and improvements to ST products and/or to this document at any time without notice. Purchasers should obtain the latest relevant information on ST products before placing orders. ST products are sold pursuant to ST's terms and conditions of sale in place at the time of order acknowledgement.

Purchasers are solely responsible for the choice, selection, and use of ST products and ST assumes no liability for application assistance or the design of Purchasers' products.

No license, express or implied, to any intellectual property right is granted by ST herein.

Resale of ST products with provisions different from the information set forth herein shall void any warranty granted by ST for such product.

ST and the ST logo are trademarks of ST. All other product or service names are the property of their respective owners.

Information in this document supersedes and replaces information previously supplied in any prior versions of this document.

© 2018 STMicroelectronics – All rights reserved

## Looking for pricing, stock, or lifecycle information?

Click below to explore more details on WIN SOURCE:

- ⊖ [View SMBJ58CA-TR on WIN SOURCE](#)
- ⊖ [STMicroelectronics Information](#)

## Optimize Your Supply Chain with WIN SOURCE Solutions

- ✓ Global Sourcing Solution
- ✓ Obsolete Management
- ✓ Cost Control Management
- ✓ Shortage Management
- ✓ Alternative Solution
- ✓ Excess Inventory Management