



# MSA-0736

## Cascadable Silicon Bipolar MMIC Amplifier



### Data Sheet

#### Description

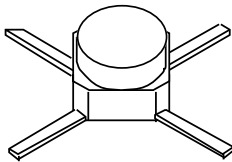
The MSA-0736 is a high performance silicon bipolar Monolithic Microwave Integrated Circuit (MMIC) housed in a cost effective, microstrip package. This MMIC is designed for use as a general purpose 50Ω gain block. Typical applications include narrow and broad band IF and RF amplifiers in industrial and military applications.

The MSA-series is fabricated using Avago's 10 GHz  $f_T$ , 25 GHz  $f_{MAX}$ , silicon bipolar MMIC process which uses nitride self-alignment, ion implantation, and gold metallization to achieve excellent performance, uniformity and reliability. The use of an external bias resistor for temperature and current stability also allows bias flexibility.

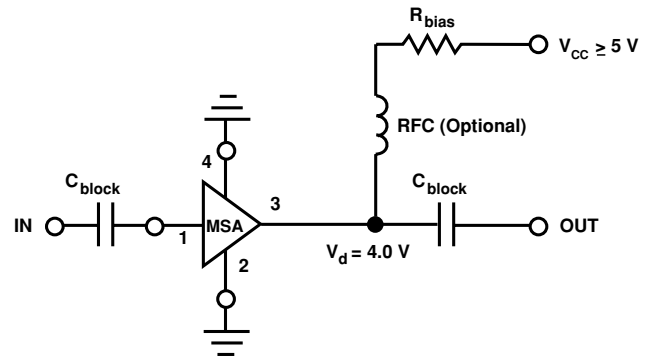
#### Features

- Cascadable 50Ω Gain Block
- Low Operating Voltage: 4.0 V Typical  $V_d$
- 3 dB Bandwidth: DC to 2.4 GHz
- 13.0 dB Typical Gain at 1.0 GHz
- Unconditionally Stable ( $k > 1$ )
- Cost Effective Ceramic Microstrip Package

#### 36 micro-X Package



#### Typical Biasing Configuration



### MSA-0736 Absolute Maximum Ratings

Parameter	Absolute Maximum <sup>[1]</sup>
Device Current	60 mA
Power Dissipation <sup>[2,3]</sup>	275 mW
RF Input Power	+13 dBm
Junction Temperature	150°C
Storage Temperature	-65 to 150°C

### Thermal Resistance<sup>[2,5]</sup>:

$$\theta_{jc} = 155^{\circ}\text{C}/\text{W}$$

#### Notes:

1. Permanent damage may occur if any of these limits are exceeded.
2.  $T_{\text{CASE}} = 25^{\circ}\text{C}$ .
3. Derate at  $6.5 \text{ mW}/^{\circ}\text{C}$  for  $T_{\text{C}} > 157^{\circ}\text{C}$ .
4. Storage above  $+150^{\circ}\text{C}$  may tarnish the leads of this package making it difficult to solder into a circuit.
5. The small spot size of this technique results in a higher, though more accurate determination of  $\theta_{jc}$  than do alternate methods.

### Electrical Specifications<sup>[1]</sup>, $T_{\text{A}} = 25^{\circ}\text{C}$

Symbol	Parameters and Test Conditions: $I_{\text{d}} = 22 \text{ mA}$ , $Z_0 = 50 \Omega$	Units	Min.	Typ.	Max.
$G_{\text{P}}$	Power Gain ( $ S_{21} ^2$ ) $f = 0.1 \text{ GHz}$	dB	12.5	13.5	14.5
$\Delta G_{\text{P}}$	Gain Flatness $f = 0.1 \text{ to } 1.3 \text{ GHz}$	dB		$\pm 0.6$	$\pm 1.0$
$f_3 \text{ dB}$	3 dB Bandwidth	GHz		2.4	
VSWR	Input VSWR $f = 0.1 \text{ to } 2.5 \text{ GHz}$			2.0:1	
	Output VSWR $f = 0.1 \text{ to } 2.5 \text{ GHz}$			1.8:1	
NF	50 $\Omega$ Noise Figure $f = 1.0 \text{ GHz}$	dB		4.5	
$P_{1 \text{ dB}}$	Output Power at 1 dB Gain Compression $f = 1.0 \text{ GHz}$	dBm		5.5	
$\text{IP}_3$	Third Order Intercept Point $f = 1.0 \text{ GHz}$	dBm		19.0	
$t_{\text{D}}$	Group Delay $f = 1.0 \text{ GHz}$	psec		140	
$V_{\text{d}}$	Device Voltage	V	3.6	4.0	4.4
$dV/dT$	Device Voltage Temperature Coefficient	$\text{mV}/^{\circ}\text{C}$		-7.0	

#### Note:

1. The recommended operating current range for this device is 15 to 40 mA. Typical performance as a function of current is on the following page.

### Ordering Information

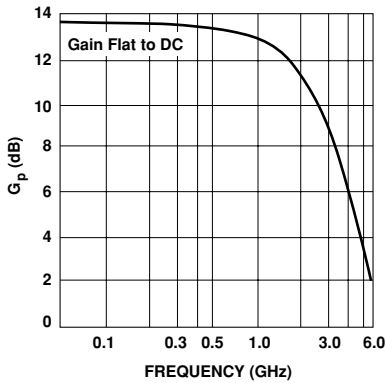
Part Numbers	No. of Devices	Comments
MSA-0736-BLKG	100	Bulk
MSA-0736-TR1G	1000	7" Reel

**MSA-0736 Typical Scattering Parameters ( $Z_0 = 50 \Omega$ ,  $T_A = 25^\circ\text{C}$ ,  $I_d = 22 \text{ mA}$ )**

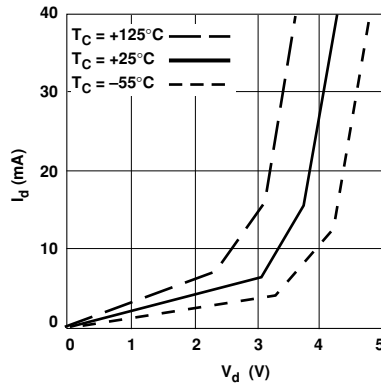
Freq. GHz	$S_{11}$		$S_{21}$			$S_{12}$			$S_{22}$	
	Mag	Ang	dB	Mag	Ang	dB	Mag	Ang	Mag	Ang
0.1	.13	-3	13.5	4.71	175	-19.0	.112	2	.29	-7
0.2	.13	-6	13.4	4.69	170	-18.5	.119	3	.29	-12
0.4	.14	-13	13.4	4.68	160	-18.6	.118	6	.29	-24
0.6	.16	-20	13.3	4.64	150	-18.4	.120	7	.28	-35
0.8	.19	-29	13.2	4.60	140	-18.1	.125	8	.28	-47
1.0	.21	-40	12.9	4.42	129	-17.6	.131	10	.27	-58
1.5	.27	-71	12.2	4.07	104	-16.5	.149	10	.24	-83
2.0	.32	-107	11.5	3.74	79	-15.6	.165	7	.19	-103
2.5	.37	-134	10.3	3.26	62	-15.3	.173	5	.15	-113
3.0	.43	-160	8.8	2.76	44	-15.4	.171	0	.14	-120
3.5	.47	-179	7.5	2.37	27	-15.3	.173	-4	.16	-120
4.0	.49	167	6.2	2.05	12	-15.2	.168	-6	.21	-121
5.0	.51	134	4.0	1.59	-15	-15.2	.173	-11	.28	-135
6.0	.60	96	2.1	1.27	-42	-14.6	.185	-16	.29	-167

**Typical Performance,  $T_A = 25^\circ\text{C}$**

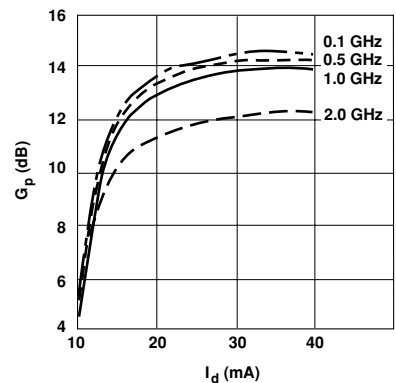
(unless otherwise noted)



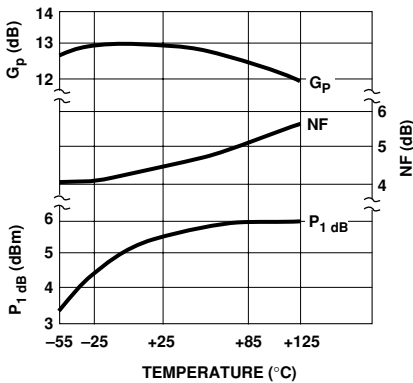
**Figure 1. Typical Power Gain vs. Frequency,  $I_d = 22 \text{ mA}$ .**



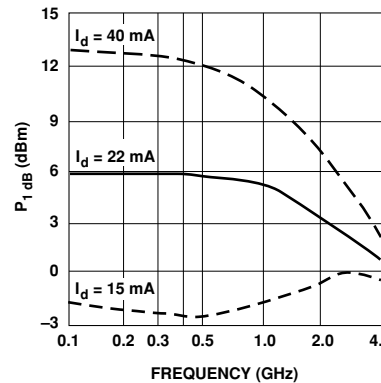
**Figure 2. Device Current vs. Voltage.**



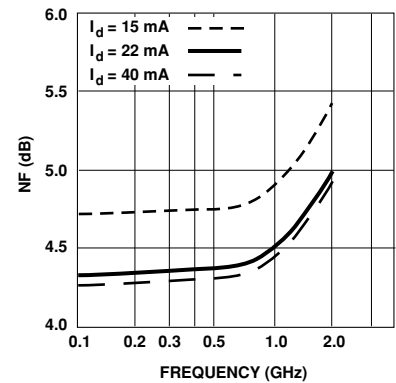
**Figure 3. Power Gain vs. Current.**



**Figure 4. Output Power at 1 dB Gain Compression, NF and Power Gain vs. Case Temperature,  $f = 1.0 \text{ GHz}$ ,  $I_d = 22 \text{ mA}$ .**

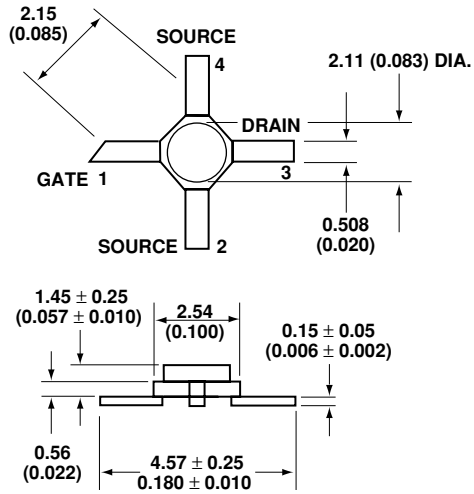


**Figure 5. Output Power at 1 dB Gain Compression vs. Frequency.**



**Figure 6. Noise Figure vs. Frequency.**

## 36 micro-X Package Dimensions



**Notes:**

1. Dimensions are in millimeters (inches)
2. Tolerances: in .xxx = ± 0.005  
mm .xx = ± 0.13



For product information and a complete list of distributors, please go to our web site: [www.avagotech.com](http://www.avagotech.com)

Avago, Avago Technologies, and the A logo are trademarks of Avago Technologies, Limited in the United States and other countries. Data subject to change. Copyright © 2007 Avago Technologies, Limited. All rights reserved. Obsoletes 5989-2741EN AV02-0305EN - April 12, 2007



## Looking for pricing, stock, or lifecycle information?

Click below to explore more details on WIN SOURCE:

-  [View MSA-0736-TR1G on WIN SOURCE](#)
-  [Broadcom Limited Information](#)

## Optimize Your Supply Chain with WIN SOURCE Solutions

-  Global Sourcing Solution
-  Obsolete Management
-  Cost Control Management
-  Shortage Management
-  Alternative Solution
-  Excess Inventory Management