



# THE DATASHEET OF BG11C



### Device Features

- OIP3 = 30.0 dBm @ 1900 MHz
- Gain = 20.8 dB @ 1900 MHz
- Output P1 = 17.3 dBm @1900 MHz
- Patented temperature compensation
- RoHS2-compliant SOT-89 SMT package



### Product Description

BeRex's BG11C is a high performance InGaP HBT MMIC amplifier is internally matched to 50 Ohms and uses a patented **temperature compensation** circuit to provide stable current over the operating temperature range without the need for external components. The BG11C is designed for high linearity gain block applications that require excellent gain flatness and over voltage protection without additional external components. It is packaged in a RoHS2-compliant SOT-89 surface mount package.

### Applications

- Base station Infrastructure/RFID
- Commercial/Industrial/Military wireless system

### Applications Circuit

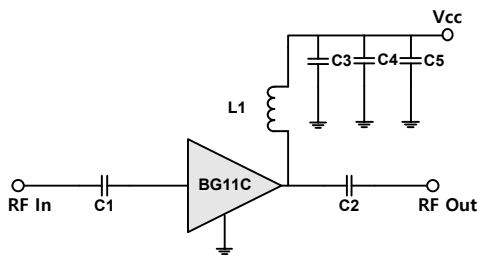

C1, C2, C3 = 100pF ± 5%, C4 = 1000pF ± 5%, C5 = 10uF, L1 = 33nH ±5%

\*C1,C2 = 12nF; L1 = 2.7uH for IF Bandwidth

### Electrical Specifications

Device performance \_ measured on a BeRex evaluation board at 25°C, Vc=5V, 50 Ω system.

Parameter	Conditions	Min	Typ	Max	Unit
Operational Frequency Range		50		4000	MHz
Test Frequency			1900		MHz
Gain		19.3	20.8		dB
Input Return Loss			-18.5		dB
Output Return Loss			-16.0		dB
Output IP3	6 dBm / tone , Δf=1 MHz	27.0	30.0		dBm
Output P1dB		16.3	17.3		dBm
Noise Figure			4.0		dB

### Recommended Operating Conditions

Parameter	Min	Typ	Max	Unit
Bandwidth	50		4000	MHz
I <sub>c</sub> @ (V <sub>c</sub> = 5V)	38	48	58	mA
V <sub>c</sub>	4.0	5	5.25	V
dG/dT		-0.004		dB/°C
R <sub>TH</sub>		50		°C/W
Operating Case Temperature	-40		+85	°C

Electrical specifications are measured at specified test conditions.

Specifications are not guaranteed over all recommended operating conditions.

### Absolute Maximum Ratings

Parameter	Rating	Unit
Storage Temperature	-55 to +155	°C
Junction Temperature	+165	°C
Supply Voltage	+6.0	V
Supply Current	160	mA
Input RF Power	23	dBm

Operation of this device above any of these parameters may result in permanent damage.

## 50-4000 MHz Cascadable InGaP HBT Gain Block

Typical Performance (Vc = 5V, Ic = 48mA, T = 25°C)

Freq	MHz	70	150	250	500	900	1900	2140	2450	3500
S21	dB	22.8	22.5	22.4	22.3	21.9	20.8	20.4	19.9	16.2
S11	dB	-18.6	-17.2	-19.0	-17.5	-18.8	-18.5	-21.8	-26.0	-8.5
S22	dB	-7.1	-10.5	-16.6	-19.4	-17.0	-16.0	-16.7	-16.1	-6.0
P1	dBm	15.9	15.9	16.0	15.8	16.4	17.3	17.0	16.5	
OIP3	dBm	29.9	28.0	30.0	28.0	29.5	30.0	29.0	28.0	
NF	dB	4.3	4.8	4.2	4.5	3.9	4.0	4.1	4.2	

Typical Performance (Vc = 4.7V, Ic = 40mA, T = 25°C)

Freq	MHz	70	500	900	1900	2140	2450	3500
S21	dB	22.6	22.0	21.7	20.6	20.4	19.8	16.2
S11	dB	-17.2	-16.3	-17.4	-17.7	-21.2	-28.4	-8.5
S22	dB	-6.9	-17.9	-15.8	-15.6	-16.8	-16.8	-6.0
P1	dBm	14.5	14.1	14.4	14.5	15.8	15.5	
OIP3	dBm	27.2	25.0	26.0	28.0	26.0	25.0	
NF	dB	4.2	4.5	3.8	4.0	4.1	4.1	

Typical Performance (Vc = 4.5V, Ic = 35mA, T = 25°C)

Freq	MHz	70	500	900	1900	2140	2450	3500
S21	dB	22.3	21.8	21.5	20.5	20.2	19.7	16.1
S11	dB	-16.1	-15.3	-16.2	-16.9	-20.1	-30.1	-8.6
S22	dB	-6.6	-16.7	-14.8	-15.1	-16.7	-17.3	-6.0
P1	dBm	13.0	12.9	13.0	14.3	13.5	15.0	
OIP3	dBm	25.6	23.0	24.0	26.0	25.0	23.0	
NF	dB	4.1	4.4	3.8	3.9	4.0	4.1	

Typical Performance (Vc = 4.0V, Ic = 35mA, T = 25°C)

Freq	MHz	70	500	900	1900	2140	2450	3500
S21	dB	21.1	20.6	20.4	19.8	19.7	19.4	15.9
S11	dB	-12.8	-11.8	-12.2	-13.1	-15.3	-21.5	-9.4
S22	dB	-5.8	-12.8	-11.6	-12.7	-15.0	-18.9	-6.3
P1	dBm	9.1	8.7	8.0	10.0	11.0	13.0	
OIP3	dBm	20.6	17.0	19.0	19.5	19.0	17.0	
NF	dB	4.0	4.4	3.7	3.8	3.9	4.0	

**V-I Characteristics**

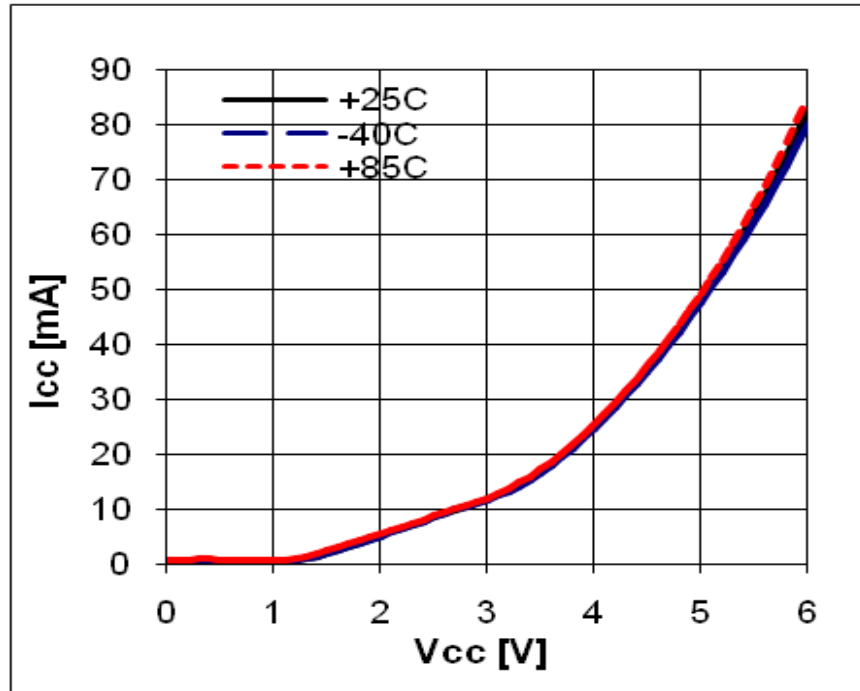

**BeRex SOT89 Evaluation Board**

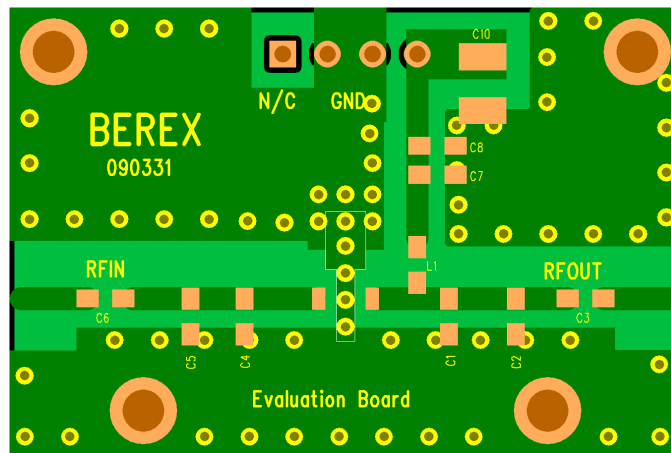

\*Dielectric constant\_ 4.2 \*RF pattern width 52mil \*31mil thick FR4 PCB

### Typical Device Data

S-parameters (Vc=5V, Ic=48mA, T=25°C)

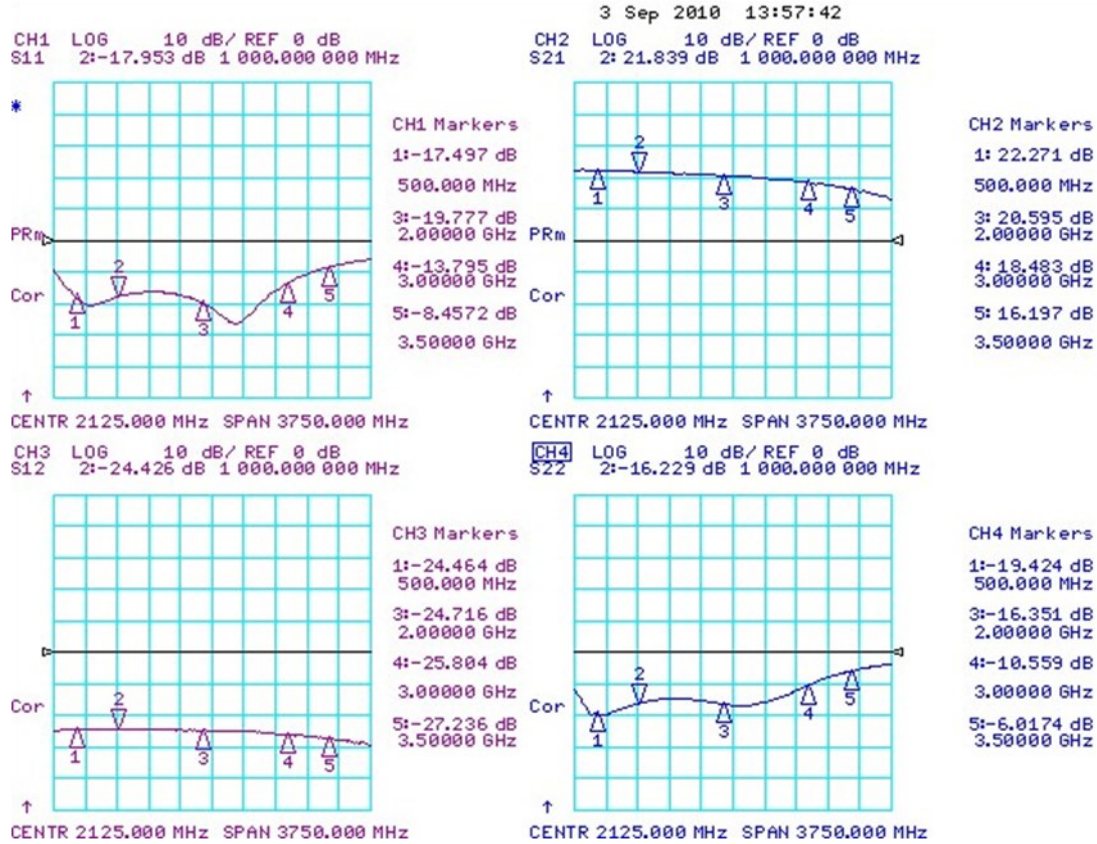

### S-Parameter

(Vdevice = 5.0V, Icc = 48mA, T = 25 °C, calibrated to device leads)

Freq [MHz]	S11 [Mag]	S11 [Ang]	S21 [Mag]	S21 [Ang]	S12 [Mag]	S12 [Ang]	S22 [Mag]	S22 [Ang]
100	0.443	-174.9	16.668	168.4	0.043	18.7	0.412	-35.0
500	0.533	148.5	13.133	149.2	0.064	3.2	0.134	-55.9
1000	0.500	115.5	13.361	128.8	0.061	-5.7	0.068	-42.3
1500	0.441	81.3	12.965	101.3	0.064	-10.7	0.047	-16.2
2000	0.336	52.9	11.607	79.4	0.060	-19.6	0.050	41.9
2500	0.257	10.3	12.000	54.8	0.062	-24.0	0.122	49.5
3000	0.155	-35.7	10.969	22.2	0.058	-31.7	0.189	26.0
3500	0.114	-105.1	8.593	-5.2	0.059	-36.1	0.297	-0.7
4000	0.131	167.8	6.650	-30.9	0.059	-44.6	0.373	-29.3

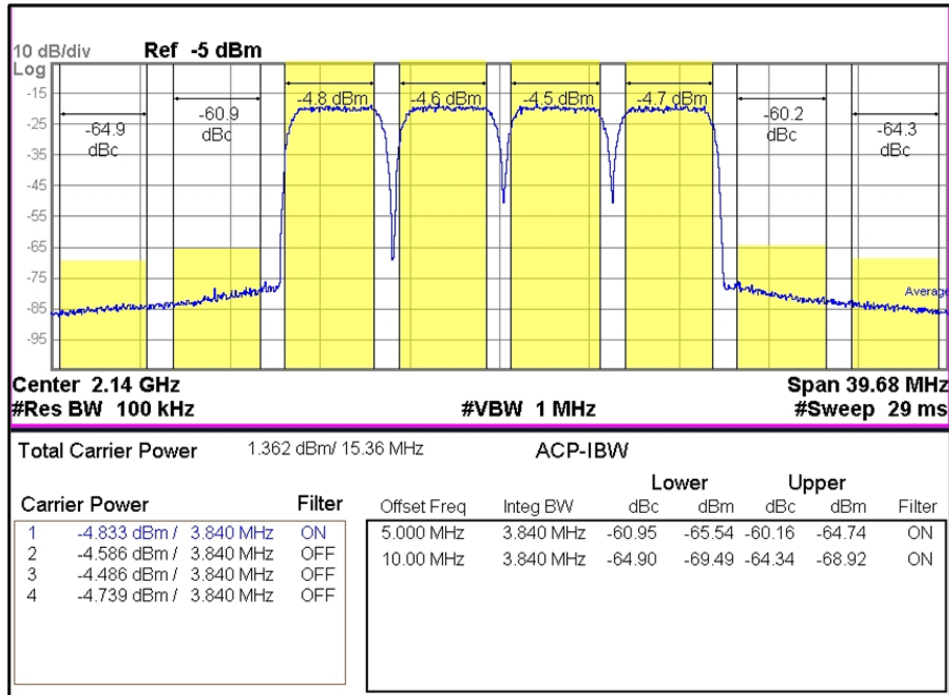
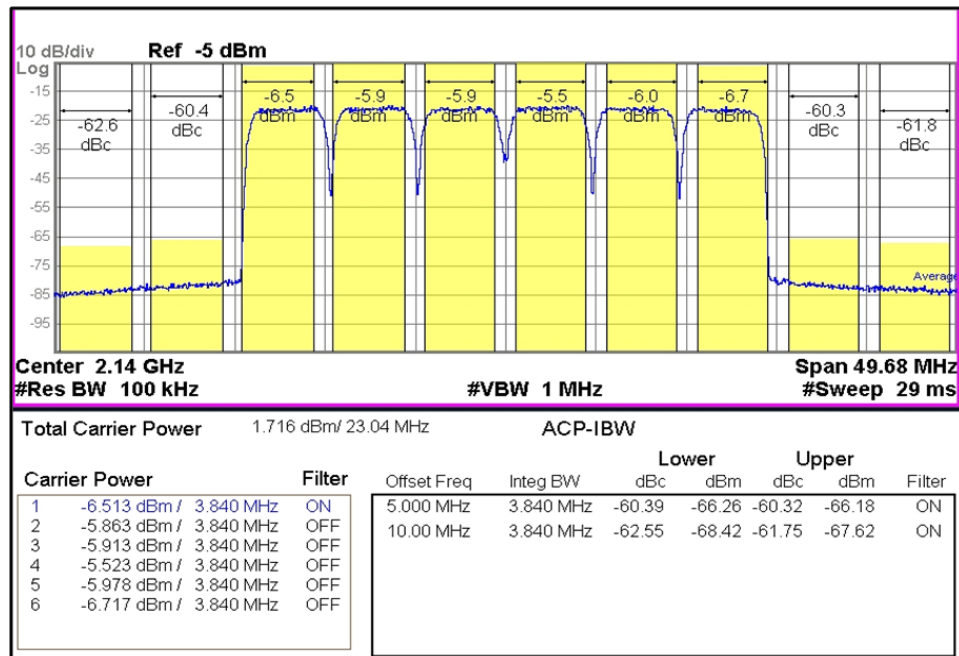
**WCDMA 4FA 2140 -60dBc**

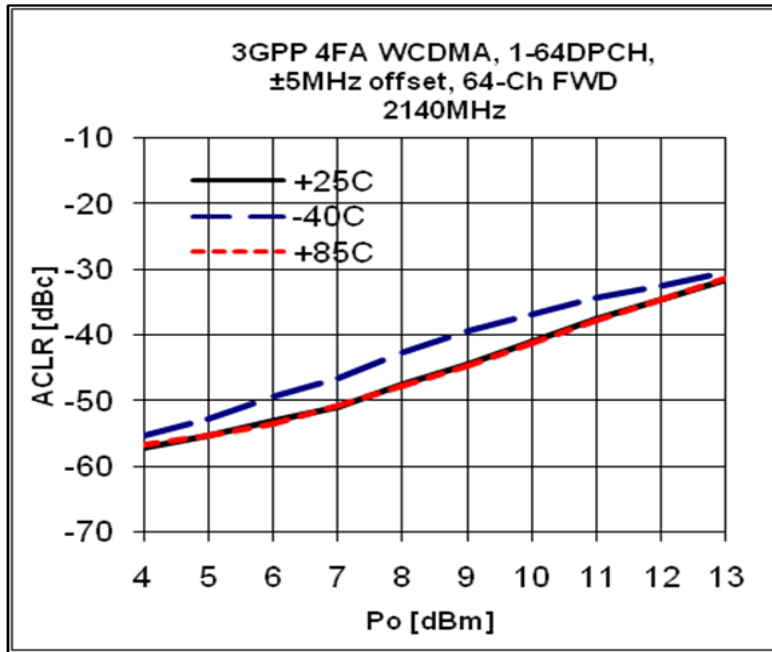
**WCDMA 6FA 2140 -60dBc**

**ACLR**

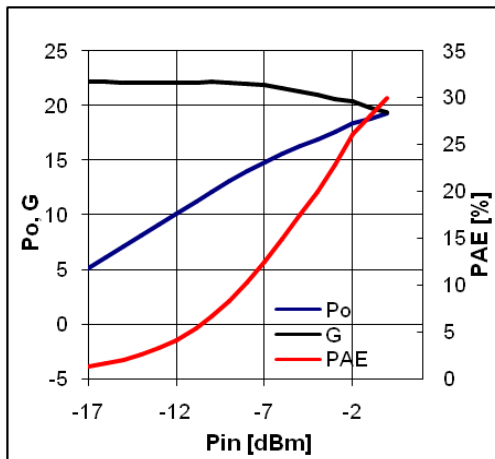
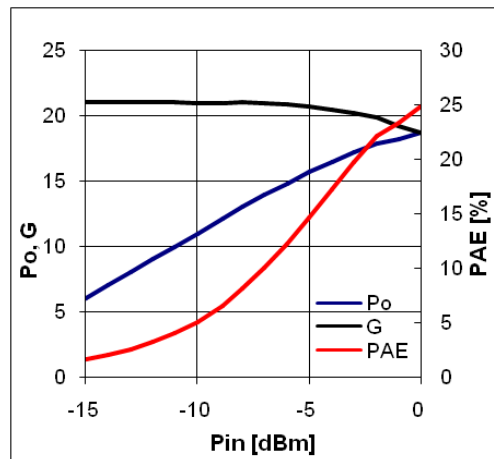
**Typical Performance**

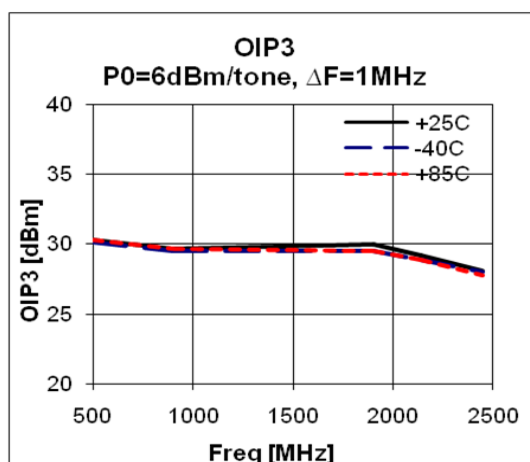
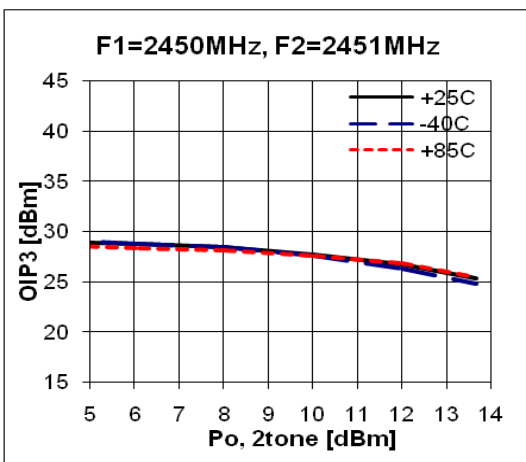
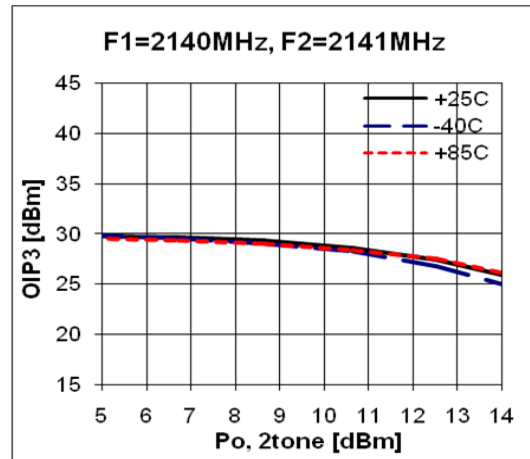
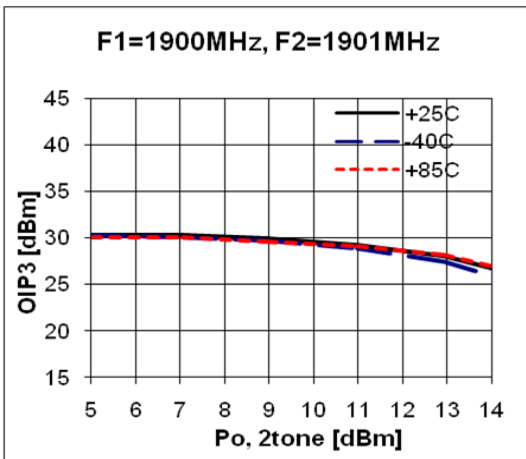
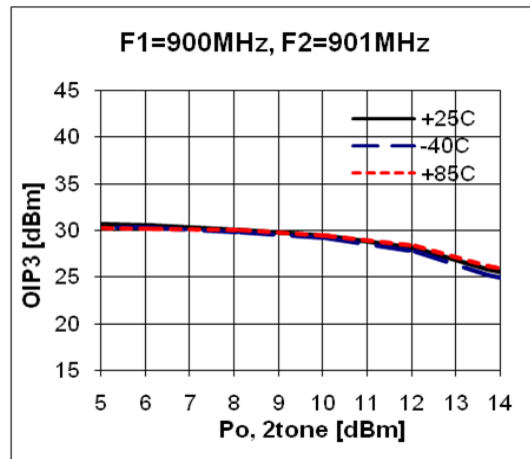
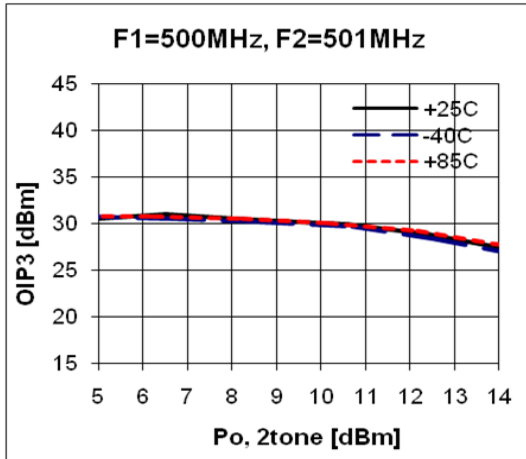
(Vc=5V, Ic=48mA, T=25°C)

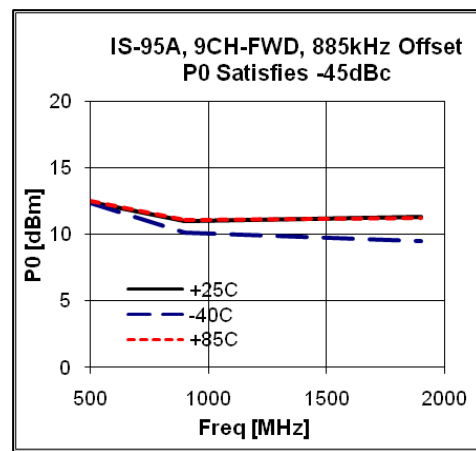
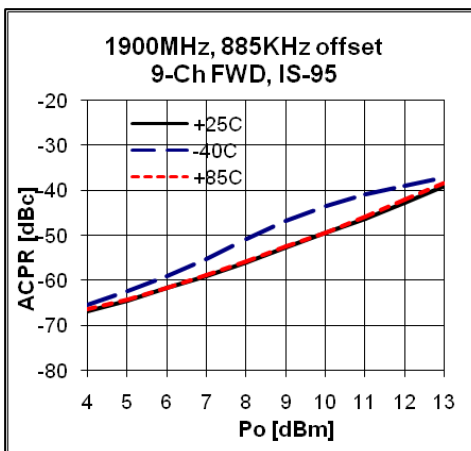
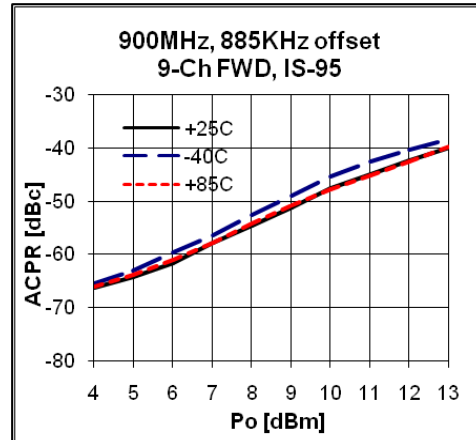
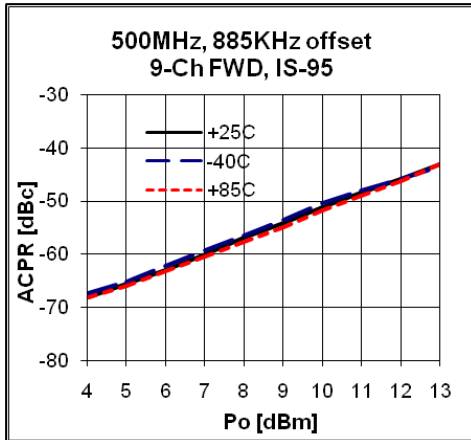
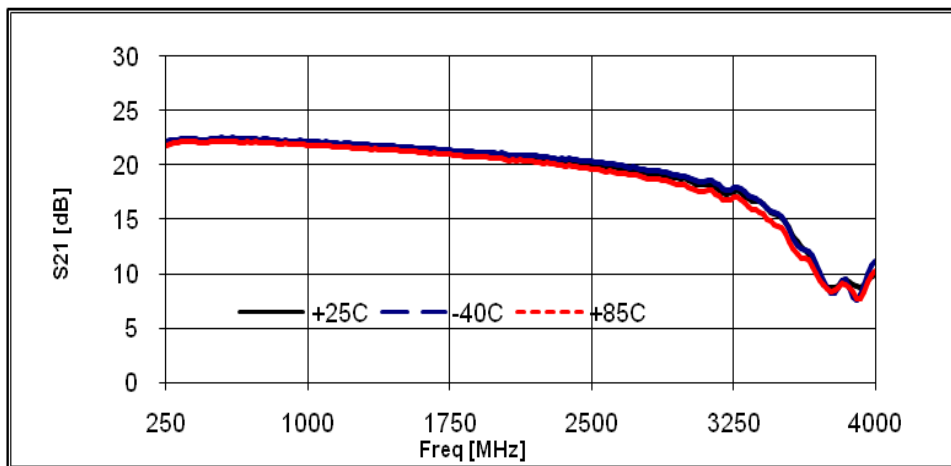
**Pin-Pout-Gain**

**900MHz**

**1900 MHz**

**OIP3**

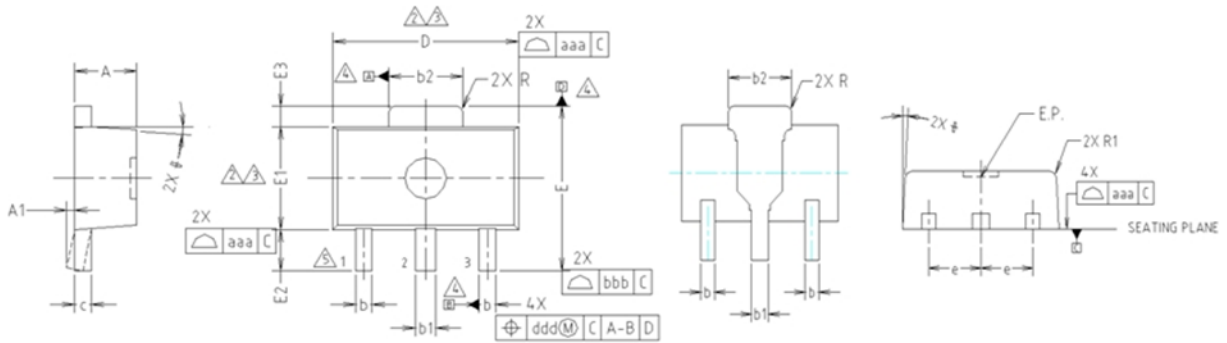
**ACPR**

**Gain Flatness**

### Package Outline Dimension



- NOTE:**  
 1. DIMENSIONS IN MILLIMETERS.
- ⚠ DIMENSION D DOES NOT INCLUDE MOLD FLASH, PROTRUSIONS OR GATE BURRS. MOLD FLASH, PROTRUSIONS OR GATE BURRS SHALL NOT EXCEED 0.5mm PER END. DIMENSION E1 DOES NOT INCLUDE INTERLEAD FLASH OR PROTRUSION. INTERLEAD FLASH OR PROTRUSION SHALL NOT EXCEED 0.5mm PER SIDE.
  - ⚠ DIMENSIONS D AND E1 ARE DETERMINED AT THE OUTMOST EXTREMES OF THE PLASTIC BODY EXCLUSIVE OF MOLD FLASH, TIE BAR BURRS, GATE BURRS AND INTERLEAD FLASH, BUT INCLUDING ANY MISMATCH BETWEEN THE TOP AND BOTTOM OF THE PLASTIC BODY.
  - ⚠ DATUMS A, B AND D TO BE DETERMINED 0.18mm FROM THE LEAD TIP.
  - ⚠ TERMINAL NUMBERS ARE SHOWN FOR REFERENCE ONLY.

SYMBOL	MILLIMETERS			NOTE
	MINIMUM	NOMINAL	MAXIMUM	
A	1.40	1.50	1.60	
A1	0.00	—	0.10	
b	0.38	0.42	0.48	
b1	0.48	0.52	0.58	
b2	1.79	1.82	1.87	
c	0.40	0.42	0.46	
D	4.40	4.50	4.70	2,3
E	3.70	4.00	4.30	
E1	2.40	2.50	2.70	2,3
E2	0.80	1.00	1.20	
E3	0.40	0.50	0.60	
e	1.50 TYP.			
φ	4° TYP.			
R	0.15 TYP.			
R1	—	—	0.20	
SYMBOL	TOLERANCES OF FORM AND POSITION		NOTE	
aaa	0.15			
bbb	0.20			
ccc	0.10			
ddd	0.10			

### Suggested PCB Land Pattern and PAD Layout

PCB Land Pattern

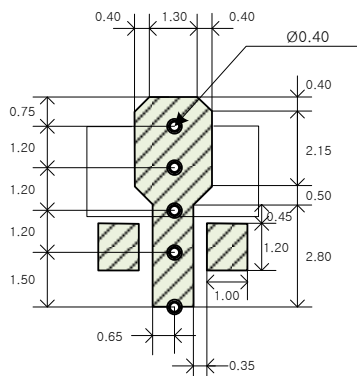

Note : All dimension \_ millimeters

PCB lay out \_ on BeRex website

PCB Mounting

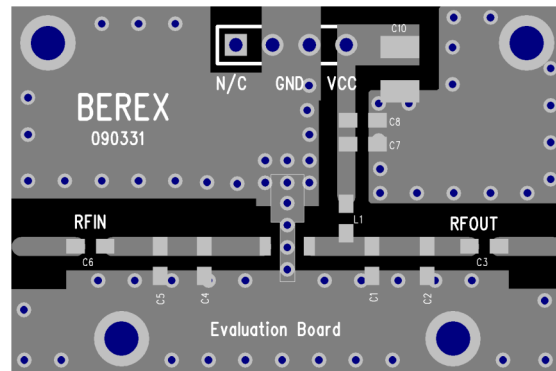

## Package Marking

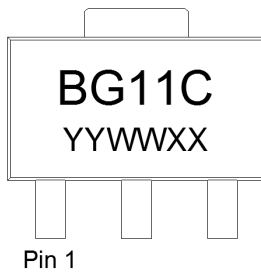

YY = Year, WW = Working Week,  
XX = Wafer No.

## Tape & Reel

SOT89

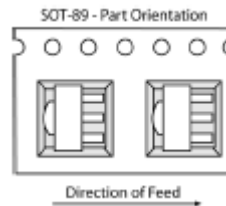

Packaging information:

Tape Width (mm): 12  
Reel Size (inches): 7  
Device Cavity Pitch (mm): 8  
Devices Per Reel: 1000

## Lead plating finish

100% Tin Matte finish

(All BeRex products undergoes a 1 hour, 150 degree C, Anneal bake to eliminate thin whisker growth concerns.)

## MSL / ESD Rating

<b>ESD Rating:</b>	Class 1C
<b>Value:</b>	<b>Passes &lt;2000V</b>
<b>Test:</b>	Human Body Model (HBM)
<b>Standard:</b>	JEDEC Standard JESD22-A114
<b>MSL Rating:</b>	<b>Level 1 at +260°C convection reflow</b>
<b>Standard:</b>	JEDEC Standard J-STD-020



Proper ESD procedures should be followed when handling this device.

**RoHS Compliance**

This part is compliant with Restrictions on the Use of Certain Hazardous Substances in Electrical and Electronic Equipment (RoHS) Directive 2011/65/EU as amended by Directive 2015/863/EU.



This product also is compliant with a concentration of the Substances of Very High Concern (SVHC) candidate list which are contained in a quantity of less than 0.1%(w/w) in each components of a product and/or its packaging placed on the European Community market by the BeRex and Suppliers.

**NATO CAGE code:**

2	N	9	6	F
---	---	---	---	---

## Looking for pricing, stock, or lifecycle information?

Click below to explore more details on WIN SOURCE:

-  [View BG11C on WIN SOURCE](#)
-  [BeRex Corporation Information](#)

## Optimize Your Supply Chain with WIN SOURCE Solutions

-  Global Sourcing Solution
-  Obsolete Management
-  Cost Control Management
-  Shortage Management
-  Alternative Solution
-  Excess Inventory Management