



**THE DATASHEET OF
LM3642TLE-LT/NOPB**



LM3642 1.5-A Synchronous Boost LED Flash Driver With High-Side Current Source

1 Features

- 1.5-A High-Side Current Source for Single LED
- > 85% Efficiency in Torch Mode (at 100 mA) and Flash Mode (at 1 A to 1.5 A)
- Accurate Programmable Flash LED Current from 93 mA to 1.5 A
- Accurate Programmable Torch LED Currents:
 - 48.4 mA to 375 mA
 - 24 mA to 187 mA (LT option)
- Small Solution Size: < 20 mm²
- Soft-Start Operation for Battery Protection
- Hardware Strobe Enable
- Synchronization Input for RF Power Amplifier Pulse Events
- V_{IN} Flash Monitor Optimization
- 400-kHz I²C-Compatible Interface
- 0.5-mm Pitch, 9-Bump DSBGA

2 Applications

Camera Phone LED Flash

3 Description

The LM3642 is a 4-MHz fixed-frequency synchronous boost converter plus 1.5-A constant current driver for a high-current white LED. The high-side current source allows for grounded cathode LED operation providing Flash current up to 1.5 A. An adaptive regulation method ensures the current source remains in regulation and maximizes efficiency.

The LM3642 is controlled via an I²C-compatible interface. Features include a hardware flash enable (STROBE) allowing a logic input to trigger the flash pulse as well as a TX input which forces the flash pulse into a low-current Torch Mode, allowing for synchronization to RF power amplifier events or other high-current conditions.

The 4-MHz switching frequency, overvoltage protection and adjustable current limit settings allow the use of tiny, low-profile inductors and (10-μF) ceramic capacitors. The device is available in a small 9-bump DSBGA package and operates over the -40°C to 85°C temperature range.

Device Information⁽¹⁾

PART NUMBER	PACKAGE	BODY SIZE (MAX)
LM3642	DSBGA (9)	1.69 mm x 1.64 mm

(1) For all available packages, see the orderable addendum at the end of the data sheet.

Simplified Schematic

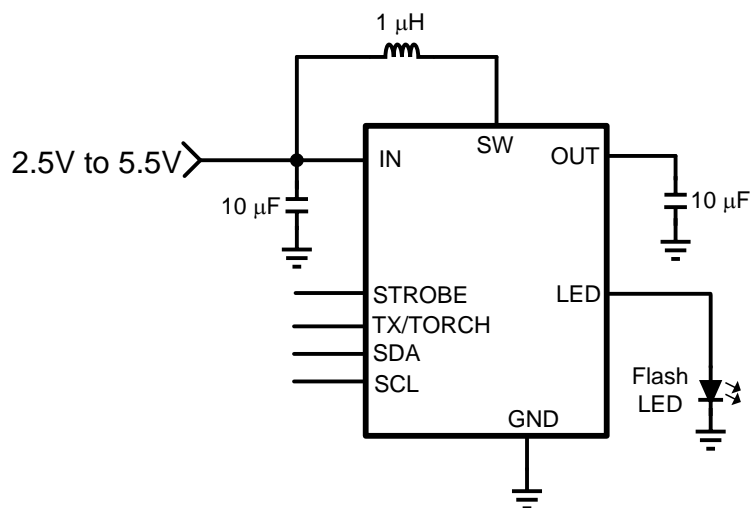

Table of Contents

1 Features	1	7.5 Programming.....	12
2 Applications	1	7.6 Register Map.....	15
3 Description	1	8 Application and Implementation	18
4 Revision History	2	8.1 Application Information.....	18
5 Pin Configuration and Functions	3	8.2 Typical Application	18
6 Specifications	4	9 Power Supply Recommendations	22
6.1 Absolute Maximum Ratings	4	10 Layout	22
6.2 ESD Ratings.....	4	10.1 Layout Guidelines	22
6.3 Recommended Operating Conditions.....	4	10.2 Layout Example	23
6.4 Thermal Information	4	11 Device and Documentation Support	24
6.5 Electrical Characteristics.....	5	11.1 Device Support.....	24
6.6 Timing Requirements	6	11.2 Documentation Support	24
6.7 Typical Characteristics	7	11.3 Trademarks	24
7 Detailed Description	9	11.4 Community Resources.....	24
7.1 Overview	9	11.5 Electrostatic Discharge Caution.....	24
7.2 Functional Block Diagram	9	11.6 Glossary	24
7.3 Feature Description.....	10	12 Mechanical, Packaging, and Orderable Information	24
7.4 Device Functional Modes.....	11		

4 Revision History

NOTE: Page numbers for previous revisions may differ from page numbers in the current version.

Changes from Revision G (December 2014) to Revision H	Page
• Changed <i>Handling Ratings</i> table to <i>ESD Ratings</i> table per SDS format; move Storage Temp to <i>Abs Max</i> table	4
• Added "If an I2C command is used to terminate the flash event, TI recommends selecting a flash time-out level 100 ms above the desired flash duration ." to end of <i>Flash Time-Out</i> subsection.....	10

Changes from Revision F (December 2013) to Revision G	Page
• Added <i>Pin Configuration and Functions</i> section, <i>Handling Rating</i> table, <i>Feature Description</i> section, <i>Device Functional Modes</i> , <i>Application and Implementation</i> section, <i>Power Supply Recommendations</i> section, <i>Layout</i> section, <i>Device and Documentation Support</i> section, and <i>Mechanical, Packaging, and Orderable Information</i> section	1
• Added updated full <i>Thermal Information</i>	4

Changes from Revision E (May 2013) to Revision F	Page
• Deleted TX interrupt	9

5 Pin Configuration and Functions

YZR Package
9-Pin DSBGA
Top View
Top View

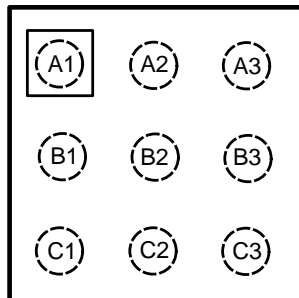

Pin Functions

PIN		I/O	DESCRIPTION
NO.	NAME		
A1	OUT	Power	Step-up DC-DC converter output. Connect a 10- μ F ceramic capacitor between this pin and GND.
A2	SW	Power	Drain connection for internal NMOS and synchronous PMOS switches.
A3	GND	Ground	Ground
B1	LED	Output	High-side current source output for Flash LED.
B2	STROBE	Input	Active high hardware Flash enable. Drive STROBE high to turn on Flash pulse. Has an internal pulldown resistor of 300 k Ω between STROBE and GND.
B3	IN	Power	Input voltage connection. Connect IN to the input supply, and bypass to GND with a 10- μ F or larger ceramic capacitor.
C1	TX/TORCH	Input	Configurable power amplifier synchronization input or configurable active high Torch enable. Has an internal pulldown resistor of 300 k Ω between TX and GND.
C2	SDA	Input/Output	Serial data input/output.
C3	SCL	Input	Serial clock input.

6 Specifications

6.1 Absolute Maximum Ratings

 over operating free-air temperature range (unless otherwise noted)⁽¹⁾⁽²⁾⁽³⁾

	MIN	MAX	UNIT
V_{IN}, V_{SW}, V_{OUT}	-0.3	6	V
$V_{SCL}, V_{SDA}, V_{STROBE}, V_{TX}, V_{LED}$	-0.3	the lesser of $(V_{IN}+0.3)$ w/ V_{max}	V
Continuous power dissipation ⁽⁴⁾		Internally limited	
Junction temperature (T_{J-MAX})		150	°C
Maximum lead temperature (soldering)		See ⁽⁵⁾	
Storage temperature, T_{stg}	-65	150	°C

- (1) Stresses beyond those listed under *Absolute Maximum Ratings* may cause permanent damage to the device. These are stress ratings only, which do not imply functional operation of the device at these or any other conditions beyond those indicated under *Recommended Operating Conditions*. Exposure to absolute-maximum-rated conditions for extended periods may affect device reliability.
- (2) All voltages are with respect to the potential at the GND pin.
- (3) If Military/Aerospace specified devices are required, contact the TI Sales Office/Distributors for availability and specifications.
- (4) Internal thermal shutdown circuitry protects the device from permanent damage. Thermal shutdown engages at $T_J=150^\circ\text{C}$ (typical) and disengages at $T_J = 135^\circ\text{C}$ (typical). Thermal shutdown is verified by design.
- (5) For detailed soldering specifications and information, refer to Texas Instruments Application Note 1112: *DSBGA Wafer Level Chip Scale Package* (SNVA009).

6.2 ESD Ratings

	VALUE	UNIT
$V_{(ESD)}$ Electrostatic discharge Human-body model (HBM), per ANSI/ESDA/JEDEC JS-001 ⁽¹⁾	±2000	V

- (1) JEDEC document JEP155 states that 500-V HBM allows safe manufacturing with a standard ESD control process.

6.3 Recommended Operating Conditions

 over operating free-air temperature range (unless otherwise noted)⁽¹⁾

	MIN	MAX	UNIT
V_{IN}	2.5	5.5	V
Junction temperature (T_J)	-40	125	°C
Ambient temperature (T_A) ⁽²⁾	-40	85	°C

- (1) All voltages are with respect to the potential at the GND pin.
- (2) In applications where high power dissipation and/or poor package thermal resistance is present, the maximum ambient temperature may have to be derated. Maximum ambient temperature (T_{A-MAX}) is dependent on the maximum operating junction temperature ($T_{J-MAX-OP} = 125^\circ\text{C}$), the maximum power dissipation of the device in the application (P_{D-MAX}), and the junction-to-ambient thermal resistance of the part/package in the application ($R_{\theta JA}$), as given by the following equation: $T_{A-MAX} = T_{J-MAX-OP} - (R_{\theta JA} \times P_{D-MAX})$.

6.4 Thermal Information

THERMAL METRIC ⁽¹⁾		LM3642	UNIT
		YZR (DSBGA)	
		9 PINS	
$R_{\theta JA}$	Junction-to-ambient thermal resistance	100.0	°C/W
$R_{\theta JC(top)}$	Junction-to-case (top) thermal resistance	0.7	°C/W
$R_{\theta JB}$	Junction-to-board thermal resistance	16.4	°C/W
Ψ_{JT}	Junction-to-top characterization parameter	3.2	°C/W
Ψ_{JB}	Junction-to-board characterization parameter	16.4	°C/W
$R_{\theta JC(bot)}$	Junction-to-case (bottom) thermal resistance	n/a	°C/W

- (1) For more information about traditional and new thermal metrics, see the *Semiconductor and IC Package Thermal Metrics* application report, SPRA953.

6.5 Electrical Characteristics

MIN and MAX limits apply over the full operating ambient temperature range ($-40^{\circ}\text{C} \leq T_A \leq 85^{\circ}\text{C}$). Unless otherwise specified, $T_A = 25^{\circ}\text{C}$, $V_{\text{IN}} = 3.6\text{ V}$.⁽¹⁾⁽²⁾

PARAMETER		TEST CONDITIONS		MIN	TYP	MAX	UNIT
CURRENT SOURCE SPECIFICATIONS							
I_{LED}	Current source accuracy	1-A flash, $V_{\text{OUT}} = 4\text{ V}$		-6%	1.04	6%	A
		1.5-A flash, $V_{\text{OUT}} = 4\text{ V}$		-8%	1.5	8%	A
		24-mA torch, $V_{\text{OUT}} = 4\text{ V}$ (LM3642-LT)		-10%	24	10%	mA
		48.4 mA Torch, $V_{\text{OUT}} = 4\text{ V}$		-10%	48.4	10%	mA
V_{HR}	Current source regulation voltage	$I_{\text{LED}} = 1.5\text{ A}$	Flash		275	12%	mV
		$I_{\text{LED}} = 24\text{ mA}/48.4\text{ mA}$	Torch		150	15%	
V_{OVP}	Output overvoltage protection trip point	ON threshold		-2.8%	5	2.2%	V
		OFF threshold		-2.7%	4.88	2.3%	
STEP-UP DC-DC CONVERTER SPECIFICATIONS							
R_{PMOS}	PMOS switch on-resistance	$I_{\text{PMOS}} = 1\text{ A}$			120		m Ω
R_{NMOS}	NMOS switch on-resistance	$I_{\text{NMOS}} = 1\text{ A}$			90		
I_{CL}	Input current limit			-17%	1.6	15%	A
				-17%	1.88	15%	
V_{IVFM}	Input voltage flash monitor trip threshold			-3.2%	2.9	3.2%	V
UVLO	Undervoltage threshold	Falling V_{IN}		-4%	2.8	4%	V
f_{SW}	Switching frequency			-9%	4	9%	MHz
I_{Q}	Quiescent supply current	Device not switching pass mode			0.75		mA
I_{SB}	Standby supply current	Device disabled $2.5\text{ V} \leq V_{\text{IN}} \leq 5.5\text{ V}$			1.6	4	μA
t_{TX}	Flash-to-torch LED current settling time	TX low to high $I_{\text{LED}} = 1.5\text{ A}$ to $24\text{ mA}/48.4\text{ mA}$			4		μs
STROBE, TX VOLTAGE SPECIFICATIONS							
V_{IL}	Input logic low	$2.5\text{ V} \leq V_{\text{IN}} \leq 5.5\text{ V}$		0		0.4	V
V_{IH}	Input logic high	$2.5\text{ V} \leq V_{\text{IN}} \leq 5.5\text{ V}$		1.2		V_{IN}	
I²C-COMPATIBLE INTERFACE SPECIFICATIONS (SCL, SDA)							
V_{IL}	Input logic low	$2.5\text{ V} \leq V_{\text{IN}} \leq 5.5\text{ V}$		0		0.4	V
V_{IH}	Input logic high	$2.5\text{ V} \leq V_{\text{IN}} \leq 4.2\text{ V}$		1.2		V_{IN}	
V_{OL}	Output logic low	$I_{\text{LOAD}} = 3\text{ mA}$				400	mV

(1) All voltages are with respect to the potential at the GND pin.

(2) Minimum (Min) and Maximum (Max) limits are specified by design, test, or statistical analysis. Typical (Typ) numbers are not verified, but do represent the most likely norm. Unless otherwise specified, conditions for typical specifications are: $V_{\text{IN}} = 3.6\text{ V}$ and $T_A = 25^{\circ}\text{C}$.

6.6 Timing Requirements

See [Figure 1](#).

		MIN	NOM	MAX	UNIT
t_1	SCL clock frequency	2.4			ns
t_2	Data In setup time to SCL High	100			ns
t_3	Data out stable after SCL Low	0			ns
t_4	SDA low setup time to SCL low (start)	100			ns
t_5	SDA high hold time after SCL high (stop)	100			ns

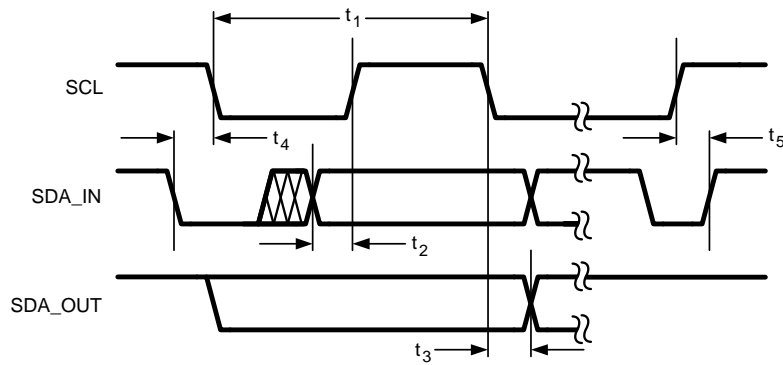

Figure 1. I²C-Compatible Interface Specifications

6.7 Typical Characteristics

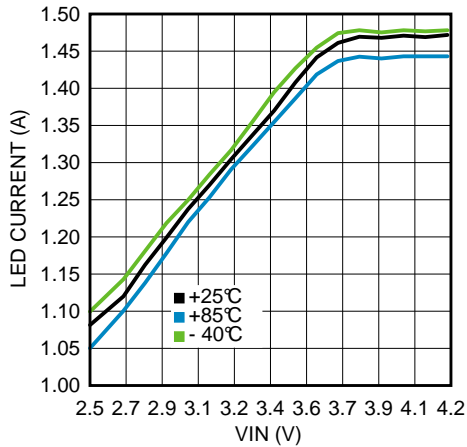

Figure 2. Flash LED Current vs. V_{IN}
 $V_{LED} = 3.8\text{ V}$, $I_{LED} = 1.5\text{ A}$

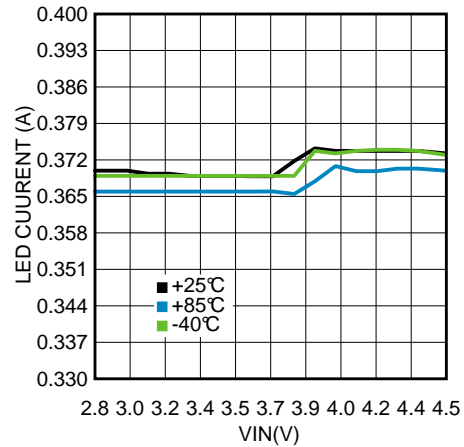

Figure 3. Torch LED Current vs. V_{IN}
 $V_{LED} = 3.7\text{ V}$, $I_{LED} = 375\text{ mA}$

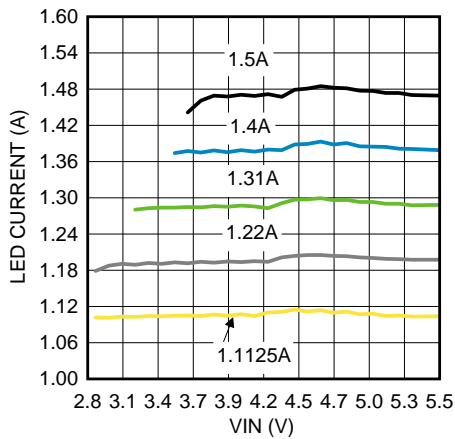

Figure 4. High Codes Flash LED Current vs. V_{IN}
 $V_{LED} = 3.8\text{ V}$, Temp = 25°C

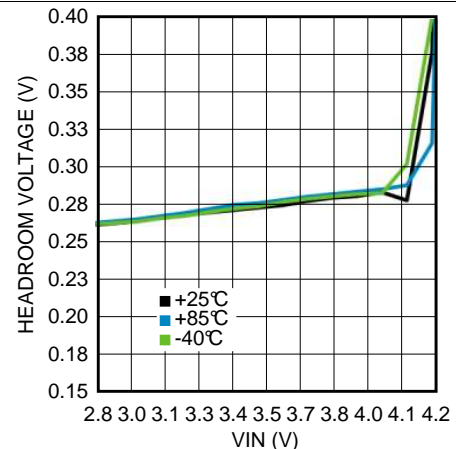

Figure 5. Flash Headroom Voltage vs. V_{IN}
 $V_{LED} = 3.8\text{ V}$, $I_{LED} = 1\text{ A}$

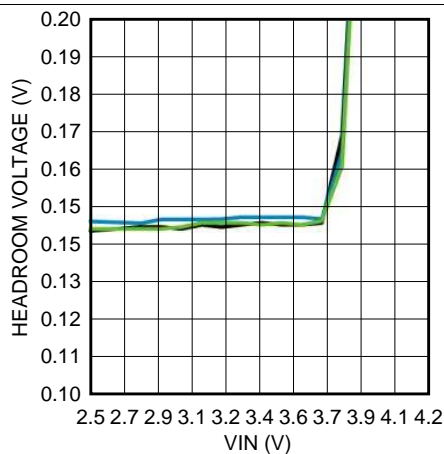

Figure 6. Torch Headroom Voltage vs. V_{IN}
 $V_{LED} = 3.7\text{ V}$, $I_{LED} = 375\text{ mA}$

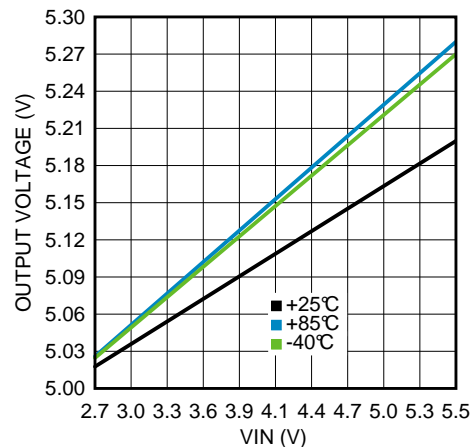

Figure 7. Output Voltage vs. V_{IN}
 $V_{LED} = 3.8\text{ V}$

Typical Characteristics (continued)

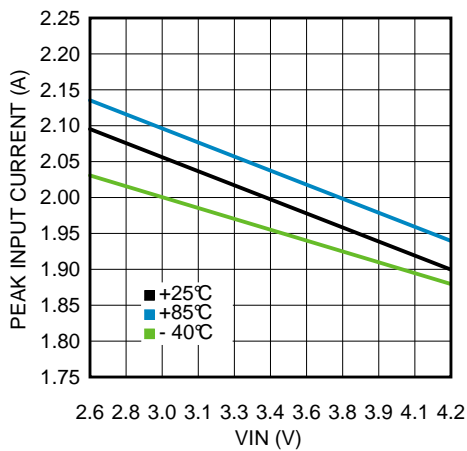

Figure 8. Peak Input Current Limit vs. V_{IN}
V_{LED} = 3.8V, I_{IN} Setting = 1.9 A

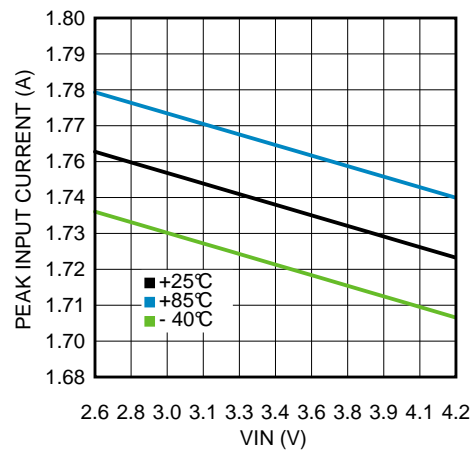

Figure 9. Peak Input Current Limit vs. V_{IN}
V_{LED} = 3.8 V, I_{IN} Setting = 1.7 A

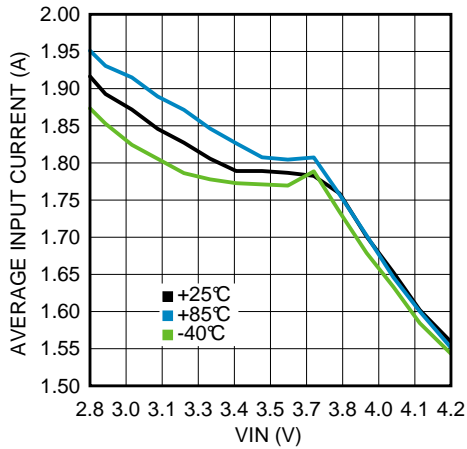

Figure 10. Average Input Current Limit vs. V_{IN}
V_{LED} = 3.8 V, I_{IN} Setting = 1.9 A

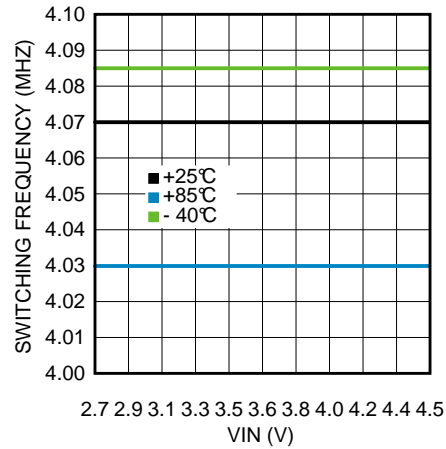

Figure 11. Switching Frequency vs. V_{IN}
V_{LED} = 3.8 V

7 Detailed Description

7.1 Overview

The LM3642 is a high-power white LED flash driver capable of delivering up to 1.5 A into a single high-powered LED. The device incorporates a 4-MHz constant frequency-synchronous current-mode PWM boost converter and a single high-side current source to regulate the LED current over the 2.5-V to 5.5-V input voltage range.

The LM3642 PWM converter switches and maintains at least V_{HR} across the current source (LED). This minimum headroom voltage ensures that the current source remains in regulation. If the input voltage is above the LED voltage + current source headroom voltage, the device does not switch and turns the PFET on continuously (Pass Mode). In Pass Mode the difference between $(V_{IN} - I_{LED} \times R_{PMOS})$ and the voltage across the LED is dropped across the current source.

The LM3642 has two logic inputs including a hardware Flash Enable (STROBE) and a Flash Interrupt input (TX/TORCH) designed to interrupt the flash pulse during high battery current conditions. Both logic inputs have internal 300-k Ω (typical) pulldown resistors to GND.

Control of the LM3642 is done via an I²C-compatible interface. This includes adjustment of the Flash and Torch current levels, changing the Flash Timeout Duration and changing the switch current limit. Additionally, there are flag and status bits that indicate flash current time-out, LED failure (open/short), device thermal shutdown, and V_{IN} undervoltage conditions.

7.2 Functional Block Diagram

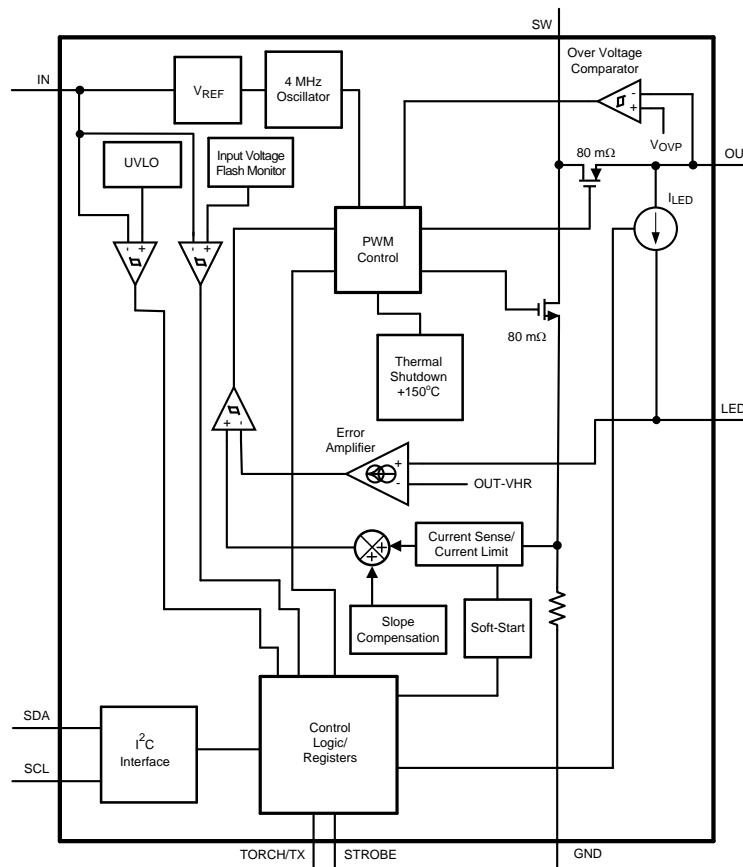

7.3 Feature Description

7.3.1 Power Amplifier Synchronization (TX/TORCH)

The TX pin is a Power Amplifier Synchronization input. This is designed to reduce the flash LED current and thus limit the battery current during high battery current conditions such as PA transmit events. When the LM3642 is engaged in a Flash event, and the TX pin is pulled high, the LED current is forced into Torch Mode at the programmed Torch current setting. If the TX pin is then pulled low before the Flash pulse terminates, the LED current will return to the previous Flash current level. At the end of the Flash time-out whether the TX pin is high or low, the LED current will turn off.

7.3.2 Input Voltage Flash Monitor (IVFM)

The LM3642 has the ability to adjust the flash current based upon the voltage level present at the IN pin utilizing an Input Voltage Flash Monitor. Upon an IVFM event, the set voltage threshold from the IVFM Mode Register sets the input voltage boundary that forces the LM3642 to stop ramping the flash current during start-up (Stop and Hold Mode).

7.3.3 Fault and Protections

7.3.3.1 Fault Operation

Upon entering a fault condition, the LM3642 will set the appropriate flag in the Flags Register.

7.3.3.2 Flash Time-Out

The Flash Time-Out period sets the amount of time that the Flash Current is being sourced from the current source (LED). The LM3642 has 8 time-out levels ranging 100 ms to 800 ms in 100-ms steps. The Flash Time-Out period is controlled in the [Flash Features Register \(0x08\)](#). Flash Time-Out only applies to the Flash Mode operation. The mode bits in the Enable Register (0x0A) are cleared upon a Flash Time-out.

If an I²C command is used to terminate the flash event, TI recommends selecting a flash time-out level 100 ms above the desired flash duration.

7.3.3.3 Overvoltage Protection (OVP)

The output voltage is limited to typically 5 V (see V_{OVP} in [Electrical Characteristics](#)). In situations such as an open LED, the LM3642 will raise the output voltage in order to keep the LED current at its target value. When V_{OUT} reaches 5 V (typ.) the overvoltage comparator will trip and turn off the internal NFET. When V_{OUT} falls below the V_{OVP} Off Threshold, the LM3642 begins switching again. The mode bits in the Enable Register are not cleared upon an OVP.

7.3.3.4 Current Limit

The LM3642 features selectable inductor current limits that are programmable through the Flash Feature Register of the I²C-compatible interface. When the inductor current limit is reached, the LM3642 will terminate the charging phase of the switching cycle.

Since the current limit is sensed in the NMOS switch, there is no mechanism to limit the current when the device operates in Pass Mode. In Boost Mode or Pass Mode if V_{OUT} falls below 2.3 V, the part stops switching, and the PFET operates as a current source limiting the current to 300 mA. This prevents damage to the LM3642 and excessive current draw from the battery during output short-circuit conditions. The mode bits in the Enable Register (0x0A) are not cleared upon a Current Limit event.

NOTE

Pulling additional current from the V_{OUT} node during normal operation is not recommended.

Feature Description (continued)

7.3.3.5 Undervoltage Lockout (UVLO)

The LM3642 has an internal comparator that monitors the voltage at IN which will force the LM3642 into shutdown if the input voltage drops to 2.8 V. If the UVLO monitor threshold is tripped, the UVLO flag bit will be set in the Flags Register. If the input voltage rises above 2.8 V, the LM3642 will not be available for operation until there is an I²C read command initiated for the Flags Register. Upon a read, the flag register will be cleared, and normal operation can resume. This feature can be disabled by writing a '0' to the UVLO EN bit in the Input Voltage Flash Monitor Register. The mode bits in the Enable Register are cleared upon a UVLO event.

7.3.3.6 Thermal Shutdown (TSD)

When the LM3642 device's die temperature reaches 150°C the boost converter shuts down, and the NFET and PFET turn off, as does the current source (LED). When the thermal shutdown threshold is tripped, a '1' gets written to the corresponding bit of the Flags Register (Thermal Shutdown bit), and the LM3642 will go into standby. The LM3642 will only be allowed to restart after the Flags Register is read, clearing the fault flag. Upon restart, if the die temperature is still above 150°C, the LM3642 will reset the fault flag and re-enter standby. The mode bits in the Enable Register are cleared upon a TSD.

7.3.3.7 LED and/or V_{OUT} Fault

The LED Fault flag in the Flags Register reads back a '1' if the part is active in Flash or Torch Mode and the LED output or the V_{OUT} node experiences short condition. The LM3642 determines an LED open condition if the OVP threshold is crossed at the OUT pin while the device is in Flash or Torch Mode. An LED short condition is determined if the voltage at LED goes below 500 mV (typ.) while the device is in Torch or Flash Mode. There is a delay of 256- μ s deglitch time before the LED flag is valid and 2.048 ms before the V_{OUT} flag is valid. This delay is the time between when the Flash or Torch current is triggered and when the LED voltage and the output voltage is sampled. The LED flag can be reset by reading back the flags register. The mode bits in the Enable Register are cleared upon an LED and/or V_{OUT} fault.

7.4 Device Functional Modes

7.4.1 Start-up (Enabling the Device)

Turnon of the LM3642 Torch and Flash Modes can be done through the Enable Register. On start-up, when V_{OUT} is less than V_{IN} the internal synchronous PFET turns on as a current source and delivers 350 mA (typ.) to the output capacitor. During this time the current source (LED) is off. When the voltage across the output capacitor reaches 2.2V (typ.), the current source will turn on. At turnon the current source will step through each Flash or Torch level until the target LED current is reached. This gives the device a controlled turnon and limits inrush current from the V_{IN} supply.

7.4.2 Pass Mode

The LM3642 starts up in Pass Mode and stays there until Boost Mode is needed to maintain regulation. If the voltage difference between V_{OUT} and V_{LED} falls below V_{HR}, the device switches to Boost Mode. In Pass Mode the boost converter does not switch and the synchronous PFET turns fully on bringing V_{OUT} up to V_{IN} - I_{LED} × R_{PMOS}. In Pass Mode the inductor current is not limited by the peak current limit. In this situation the output current must be limited to 2 A.

7.4.3 Flash Mode

In Flash Mode, the LED current source (LED) provides 16 target current levels from 93.75 mA to 1500 mA. The Flash currents are adjusted via the Current Control Register. Flash Mode is activated by the Enable Register, or by pulling the STROBE pin HIGH. Once the Flash sequence is activated the current source (LED) will ramp up to the programmed Flash current by stepping through all current steps until the programmed current is reached.

When the part is enabled in the Flash Mode through the Enable Register, all mode bits in the Enable Register are cleared after a flash time-out event.

Table 1 shows the I²C commands and the state of the mode bits, if the STROBE pin is used to enable the Flash Mode.

Device Functional Modes (continued)

Table 1. Status of Mode Bits

MODE CHANGE REQUIRED	STATUS OF MODE BITS IN THE ENABLE REGISTER AFTER A FLASH
Using Level Triggered STROBE to Flash	Mode bits are cleared after a single flash. To reflash, 0x23 will have to be written to 0x0A.

7.4.4 Torch Mode

In Torch Mode, the current source (LED) is programmed via the Current Control Register. Torch Mode is activated by the Enable Register and/or by Enabling the part in TX/Torch pin configuration. Once the Torch Mode is enabled the current source will ramp up to the programmed Torch current level. The Ramp-Up and Ramp-Down times are independently adjustable via the Torch Ramp Register. Torch Mode is not affected by Flash Timeout. In the LM3642, the programmable torch current ranges from 48.4 mA to 375 mA. With the LM3642LT option, the programmable torch current ranges from 24 mA to 187 mA.

7.4.5 Indicator Mode

This mode is activated by the Enable Register. The LM3642 can be programmed to a current level that is 1/8th the torch current value in the Current Control Register. LM3642LT has only one setting of indicator current at 5 mA.

7.5 Programming

7.5.1 I²C-Compatible Interface

7.5.1.1 Data Validity

The data on SDA line must be stable during the HIGH period of the clock signal (SCL). In other words, state of the data line can only be changed when SCL is LOW.

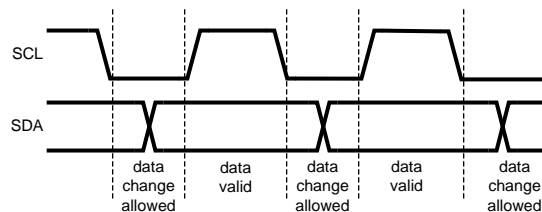

Figure 12. Data Validity Diagram

A pullup resistor between the controller's VIO line and SDA must be greater than $[(VIO - V_{OL}) / 3 \text{ mA}]$ to meet the V_{OL} requirement on SDA. Using a larger pullup resistor results in lower switching current with slower edges, while using a smaller pullup results in higher switching currents with faster edges.

7.5.1.2 Start and Stop Conditions

START and STOP conditions classify the beginning and the end of the I²C session. A START condition is defined as SDA signal transitioning from HIGH to LOW while SCL line is HIGH. A STOP condition is defined as the SDA transitioning from LOW to HIGH while SCL is HIGH. The I²C master always generates START and STOP conditions. The I²C bus is considered to be busy after a START condition and free after a STOP condition. During data transmission, the I²C master can generate repeated START conditions. First START and repeated START conditions are equivalent, function-wise.

Programming (continued)

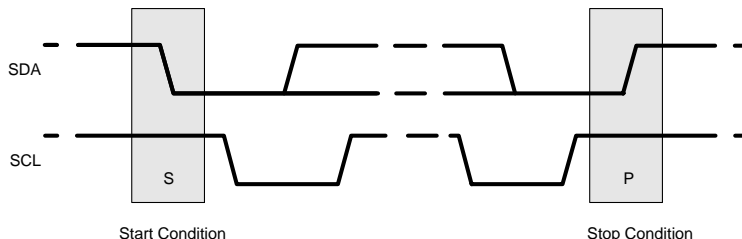
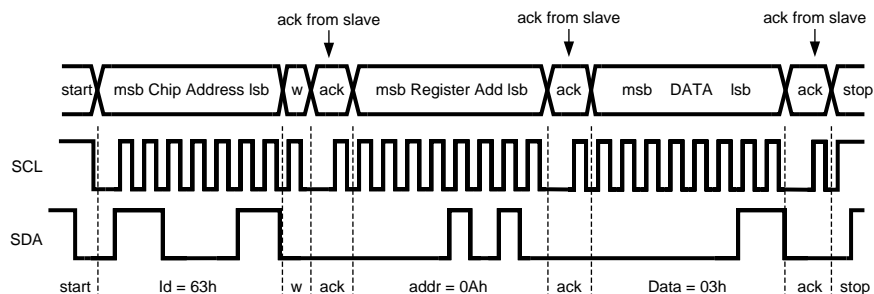

Figure 13. Start and Stop Conditions

7.5.1.3 Transferring Data

Every byte put on the SDA line must be eight bits long, with the most significant bit (MSB) transferred first. Each byte of data has to be followed by an acknowledge bit. The acknowledge related clock pulse is generated by the master. The master releases the SDA line (HIGH) during the acknowledge clock pulse. The LM3642 pulls down the SDA line during the 9th clock pulse, signifying an acknowledge. The LM3642 generates an acknowledge after each byte is received. There is no acknowledge created after data is read from the LM3642.

After the START condition, the I²C master sends a chip address. This address is seven bits long followed by an eighth bit which is a data direction bit (R/W). The LM3642 7-bit address is 0x63. For the eighth bit, a '0' indicates a WRITE and a '1' indicates a READ. The second byte selects the register to which the data will be written. The third byte contains data to write to the selected register.



w = write (SDA = "0")
 r = read (SDA = "1")
 ack = acknowledge (SDA pulled down by either master or slave)
 id = chip address, 63h for LM3642

Figure 14. Write Cycle

7.5.1.4 I²C-Compatible Chip Address

The device address for the LM3642 is 1100011 (63). After the START condition, the I²C-compatible master sends the 7-bit address followed by an eighth read or write bit (R/W). R/W = 0 indicates a WRITE, and R/W = 1 indicates a READ. The second byte following the device address selects the register address to which the data will be written. The third byte contains the data for the selected register.

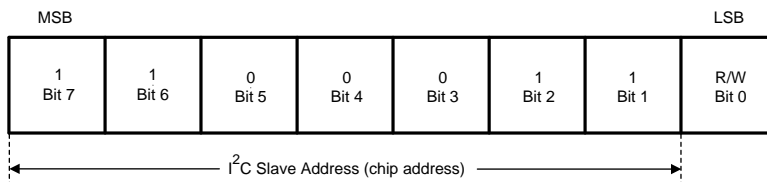

Figure 15. I²C-Compatible Device Address

Programming (continued)

7.5.1.5 Transferring Data

Every byte on the SDA line must be eight bits long, with the most significant bit (MSB) transferred first. Each byte of data must be followed by an acknowledge bit (ACK). The acknowledge related clock pulse (9th clock pulse) is generated by the master. The master releases SDA (HIGH) during the 9th clock pulse. The LM3642 pulls down SDA during the 9th clock pulse, signifying an acknowledge. An acknowledge is generated after each byte has been received.

7.6 Register Map

7.6.1 Register Descriptions

Register Name	Internal Hex Address	Power On/RESET Value
Enable Register	0x0A	00
Flags Register	0x0B	00
Flash Features Register	0x08	52
Current Control Register	0x09	0F
IVFM Mode Register	0x01	80
Torch Ramp Time Register	0x06	00
Silicon Revision Register (LM3642)	0x00	00
Silicon Revision Register (LM3642LT)	0x00	01

7.6.1.1 Enable Register (0x0A)

Bit 7	Bit 6	Bit 5	Bit 4	Bit 3	Bit 2	Bit 1	Bit 0
IVFM 0 = Disabled (default) 1 = Stop and Hold Mode	TX Pin Enable 0 = Disabled (default) 1 = Enabled	Strobe Pin Enable 0 = Disabled (default) 1 = Enabled	Torch Pin Enable 0 = Disabled (default) 1 = Enabled	RFU	RFU	Mode Bits: M1, M0 00 = Standby (default) 01 = Indicator 10 = Torch 11 = Flash	

7.6.1.2 Flags Register (0x0B)

Bit 7	Bit 6	Bit 5	Bit 4	Bit 3	Bit 2	Bit 1	Bit 0
RFU	RFU	IVFM	UVLO Flag	OVP Flag	LED or V _{OUT} Short Flag	Thermal Shutdown Fault	Timeout Flag

IVFM

IVFM down threshold crossed.

UVLO Fault

UVLO Threshold crossed.

OVP Flag

Over-voltage Protection tripped. Open Output cap or open LED.

LED Short Fault

LED Short detected.

Thermal Shutdown Fault

LM3642 die temperature reached thermal shutdown value.

Time-Out Flag

Flash Timer tripped.

NOTE

Faults require a read-back of the “Flags Register” to resume operation. Flags report an event occurred, but do not inhibit future functionality. A read-back of the Flags Register will only get updated again if the fault or flags is still present upon a restart.

7.6.1.3 Flash Features Register (0x08)

Bit 7	Bit 6	Bit 5	Bit 4	Bit 3	Bit 2	Bit 1	Bit 0
RFU	Inductor Current Limit 0 = 1.6 A 1 = 1.88 A (default)	Flash Ramp Time 000 = 256 μ s 001 = 512 μ s 010 = 1.024 ms (default) 011 = 2.048 ms 100 = 4.096 ms 101 = 8.192 ms 110 = 16.384 ms 111 = 32.768 ms			Flash Time-Out Time 000 = 100 ms 001 = 200 ms 010 = 300 ms (default) 011 = 400 ms 100 = 500 ms 101 = 600 ms 110 = 700 ms 111 = 800 ms		

7.6.1.4 Current Control Register (0x09)

Bit 7	Bit 6	Bit 5	Bit 4	Bit 3	Bit 2	Bit 1	Bit 0
RFU	Torch Current (LM3642LT) 000 = 48.4 mA (default) (24 mA) 001 = 93.74 mA (46.87 mA) 010 = 140.63 mA (70.315 mA) 011 = 187.5 mA (93.25 mA) 100 = 234.38 mA (117.19 mA) 101 = 281.25 mA (140.625 mA) 110 = 328.13 mA (164.075 mA) 111 = 375 mA (187.5 mA)			Flash Current 0000 = 93.75 mA 0001 = 187.5 mA 0010 = 281.25 mA 0011 = 375 mA 0100 = 468.75 mA 0101 = 562.5 mA 0110 = 656.25 mA 0111 = 750 mA 1000 = 843.75 mA 1001 = 937.5 mA 1010 = 1031.25 mA 1011 = 1125 mA 1100 = 1218.75 mA 1101 = 1312.5 mA 1110 = 1406.25 mA 1111 = 1500 mA (default)			

7.6.1.5 Input Voltage Flash Monitor (IVFM) Mode Register (0x01)

Bit 7	Bit 6	Bit 5	Bit 4	Bit 3	Bit 2	Bit 1	Bit 0
UVLO 0 = Disabled 1 = Enabled (default)	RFU		IVM-D (Down) Threshold 000 = 2.9 V (default) 001 = 3.0 V 010 = 3.1 V 011 = 3.2 V 100 = 3.3 V 101 = 3.4 V 110 = 3.5 V 111 = 3.6 V			RFU	

Stop and Hold Mode: Stops Current Ramp and Holds the level for the remaining flash if V_{IN} crosses IVM-D Line. Sets IVFM Flag in Flags Register upon crossing IVM-D Line.

UVLO EN: If enabled and V_{IN} drops below 2.8 V, the LM3642 will enter standby and set the UVLO flag in the Flags Register. Enabled = '1', Disabled = '0'

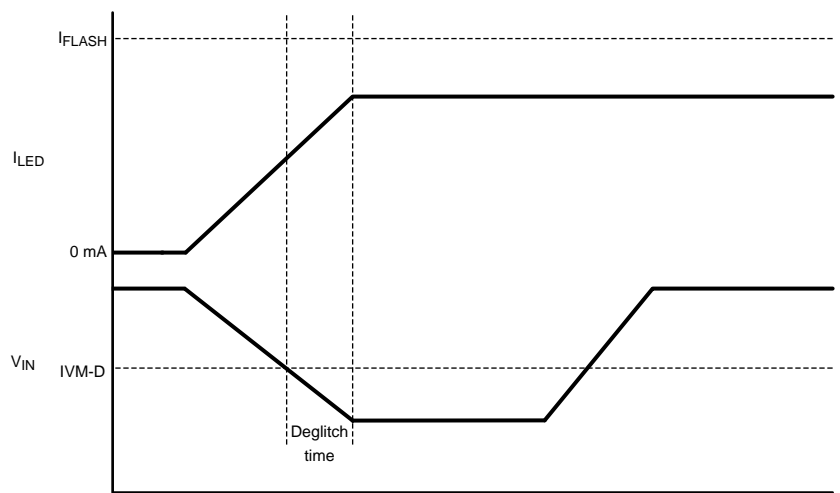

Figure 16. Stop and Hold Mode

7.6.1.6 Torch Ramp Time Register (0x06)

Bit 7	Bit 6	Bit 5	Bit 4	Bit 3	Bit 2	Bit 1)	Bit 0
RFU	RFU	Torch Ramp-Up Time 000 = 16 ms (default) 001 = 32 ms 010 = 64 ms 011 = 128 ms 100 = 256 ms 101 = 512 ms 110 = 1.024s 111 = 2.048s			Torch Ramp-Down Time 000 = 16 ms (default) 001 = 32 ms 010 = 64 ms 011 = 128 ms 100 = 256 ms 101 = 512 ms 110 = 1.024s 111 = 2.048s		

7.6.1.7 Silicon Revision Register

Bit 7	Bit 6	Bit 5	Bit 4	Bit 3	Bit 2	Bit 1	Bit 0
RFU					000 = LM3642		

8 Application and Implementation

NOTE

Information in the following applications sections is not part of the TI component specification, and TI does not warrant its accuracy or completeness. TI's customers are responsible for determining suitability of components for their purposes. Customers should validate and test their design implementation to confirm system functionality.

8.1 Application Information

The LM3642 can drive one flash LED at currents up to 1.5 A. The 4-MHz DC-DC boost regulator allows for the use of small value discrete external components.

8.2 Typical Application

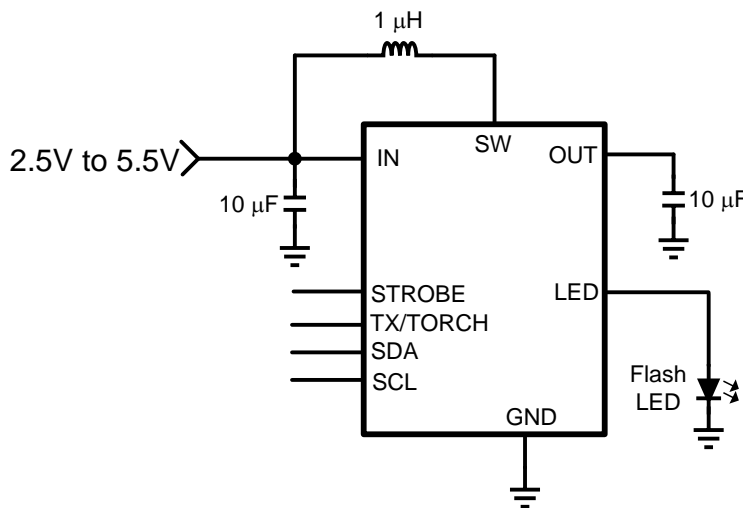

Figure 17. Typical Application Circuit

8.2.1 Design Requirements

Example requirements based on default register values:

Table 2. Design Parameters

DESIGN PARAMETER	EXAMPLE VALUE
Input voltage range	2.5 V to 5.5 V
Brightness control	I2C Register
LED configuration	1 Flash LED
Boost switching frequency	4 MHz
Flash brightness	1.5 A maximum

Table 3. Application Circuit Component List

COMPONENT	MANUFACTURER	VALUE	PART NUMBER	SIZE	CURRENT/VOLTAGE RATING (RESISTANCE)
L	TOKO	1 µH	DFE201610C	2 mm × 1.6 mm × 1 mm	2.5 A
COU CIN	Murata	10 µF	GRM188R60J106M	1.6 mm × 0.8 mm × 0.8 mm (0603)	6.3 V
LED	Lumiled		PWF-4		VF = 3.6 V, @1.5 A

8.2.2 Detailed Design Procedure

8.2.2.1 Output Capacitor Selection

The LM3642 is designed to operate with at least a 10- μ F ceramic output capacitor. When the boost converter is running the output capacitor supplies the load current during the boost converter's on-time. When the NMOS switch turns off the inductor energy is discharged through the internal PMOS switch, supplying power to the load and restoring charge to the output capacitor. This causes a sag in the output voltage during the on-time and a rise in the output voltage during the off-time. The output capacitor is therefore chosen to limit the output ripple to an acceptable level depending on load current and input/output voltage differentials and also to ensure the converter remains stable.

For proper operation the output capacitor must be at least a 10- μ F ceramic. Larger capacitors such as a 22- μ F capacitor or capacitors in parallel can be used if lower output voltage ripple is desired. To estimate the output voltage ripple considering the ripple due to capacitor discharge (ΔV_Q) and the ripple due to the capacitors ESR (ΔV_{ESR}) use the following equations:

For continuous conduction mode, the output voltage ripple due to the capacitor discharge is:

$$\Delta V_Q = \frac{I_{LED} \times (V_{OUT} - V_{IN})}{f_{SW} \times V_{OUT} \times C_{OUT}} \quad (1)$$

The output voltage ripple due to the output capacitors ESR is found by:

$$\Delta V_{ESR} = R_{ESR} \times \left(\frac{I_{LED} \times V_{OUT}}{V_{IN}} \right) + \Delta I_L$$

where

$$\Delta I_L = \frac{V_{IN} \times (V_{OUT} - V_{IN})}{2 \times f_{SW} \times L \times V_{OUT}} \quad (2)$$

In ceramic capacitors the ESR is very low so a close approximation is to assume that 80% of the output voltage ripple is due to capacitor discharge and 20% from ESR. [Table 4](#) lists different manufacturers for various output capacitors and their case sizes suitable for use with the LM3642.

8.2.2.2 Input Capacitor Selection

Choosing the correct size and type of input capacitor helps minimize the voltage ripple caused by the switching of the LM3642 device's boost converter, and reduces noise on the boost converter's input terminal that can feed through and disrupt internal analog signals. In the typical application circuit a 10- μ F ceramic input capacitor works well. It is important to place the input capacitor as close as possible to the LM3642 device's input (IN) pin. This reduces the series resistance and inductance that can inject noise into the device due to the input switching currents. [Table 4](#) lists various input capacitors that are recommended for use with the LM3642.

Table 4. Recommended Input and Output Capacitors (X5R/X7R Dielectric)

MANUFACTURER	PART NUMBER	VALUE	CASE SIZE	VOLTAGE RATING
TDK Corporation	C1608JB0J106M	10 μ F	0603 (1.6 mm \times 0.8 mm \times 0.8 mm)	6.3 V
TDK Corporation	C2012JB1A106M	10 μ F	0805 (2 mm \times 1.25 mm \times 1.25 mm)	10 V
TDK Corporation	C2012JB0J226M	22 μ F	0805 (2 mm \times 1.25 mm \times 1.25 mm)	6.3 V
Murata	GRM188R60J106M	10 μ F	0603 (1.6 mm \times 0.8 mm \times 0.8 mm)	6.3 V
Murata	GRM21BR61A106KE19	10 μ F	0805 (2 mm \times 1.25 mm \times 1.25 mm)	10 V
Murata	GRM21BR60J226ME39L	22 μ F	0805 (2 mm \times 1.25 mm \times 1.25 mm)	6.3 V

8.2.2.3 Inductor Selection

The LM3642 is designed to use a 1- μ H or 0.47- μ H inductor. [Table 5](#) lists various inductors and their manufacturers that can work well with the LM3642. When the device is boosting ($V_{OUT} > V_{IN}$) the inductor will typically be the largest area of efficiency loss in the circuit. Therefore, choosing an inductor with the lowest possible series resistance is important. Additionally, the saturation rating of the inductor should be greater than the maximum operating peak current of the LM3642. This prevents excess efficiency loss that can occur with inductors that operate in saturation. For proper inductor operation and circuit performance, ensure that the inductor saturation and the peak current limit setting of the LM3642 are greater than I_{PEAK} in the following calculation:

$$I_{PEAK} = \frac{I_{LOAD}}{\eta} \times \frac{V_{OUT}}{V_{IN}} + \Delta I_L \quad \text{where} \quad \Delta I_L = \frac{V_{IN} \times (V_{OUT} - V_{IN})}{2 \times f_{SW} \times L \times V_{OUT}} \quad (3)$$

where $f_{SW} = 4 \text{ MHz}$, and efficiency can be found in the *Typical Characteristics* plots.

Table 5. Recommended Inductors

MANUFACTURER	L	PART NUMBER	DIMENSIONS (LxWxH)	I _{SAT}	R _{DC}
TOKO	1 μH	DFE252010C	2.5 mm x 2 mm x 1 mm	2.7 A	78 mΩ
TOKO	1 μH	DFE252012C	2.5 mm x 2 mm x 1.2 mm	3 A	59 mΩ
TOKO	0.47 μH	DFE201612C	2 mm x 1.6 mm x 1.2 mm	3.4 A	82 mΩ
TOKO	1 μH	DFE201610C	2 mm x 1.6 mm x 1 mm	2.5 A	79 mΩ

8.2.3 Application Curves

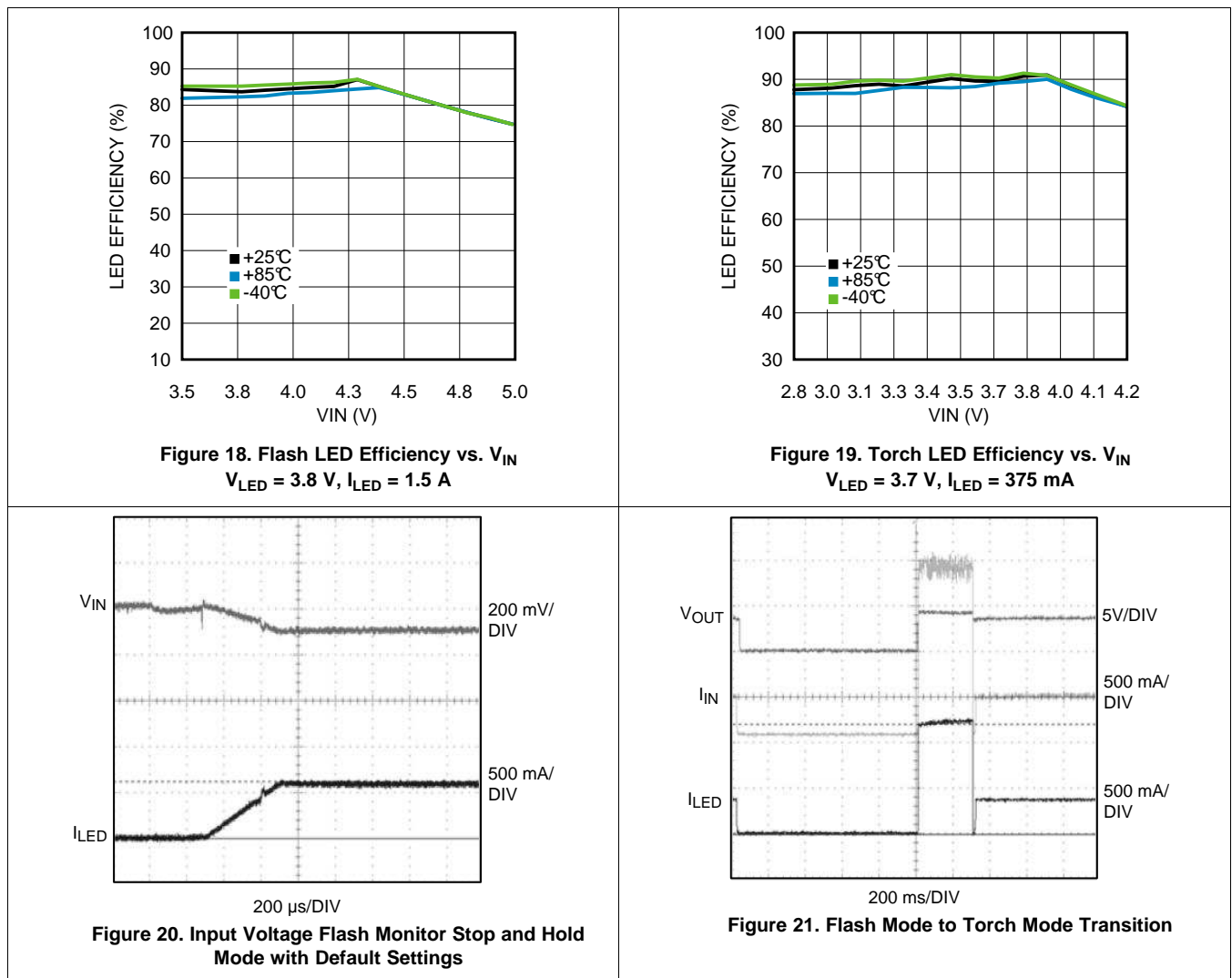

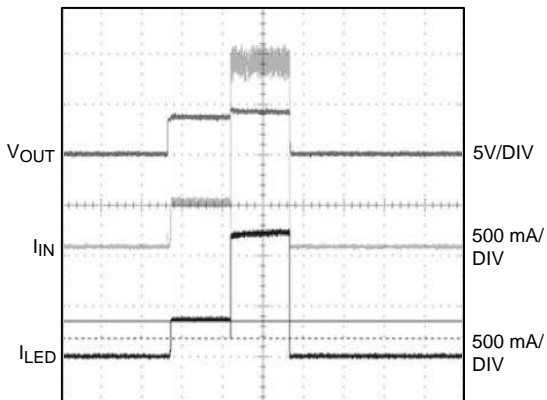

200 ms/DIV

Figure 22. Torch Mode to Flash Mode Transition

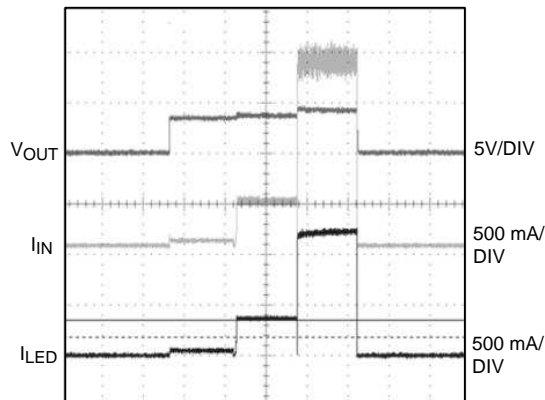

200 ms/DIV

Figure 23. Indicator Mode - Torch Mode - Flash Mode Transitions

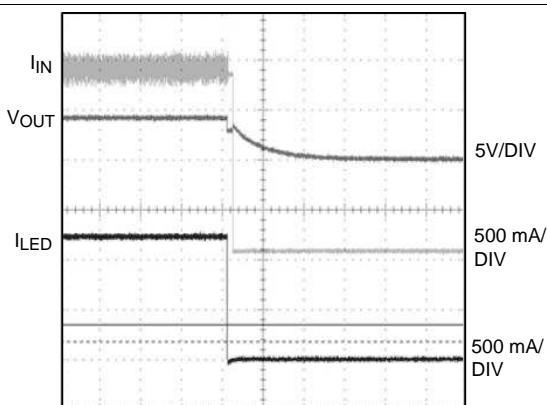

2 ms/DIV

Figure 24. V_{LED} Short Fault

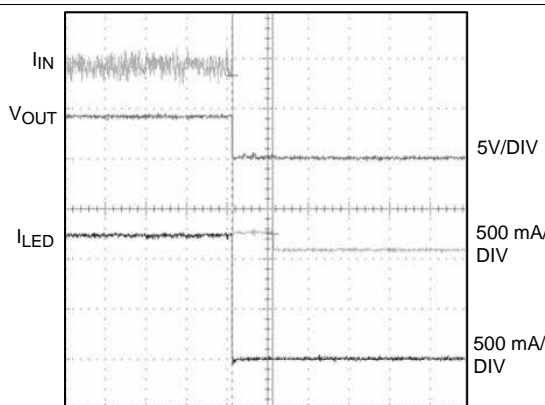

2 ms/DIV

Figure 25. V_{OUT} Short Fault

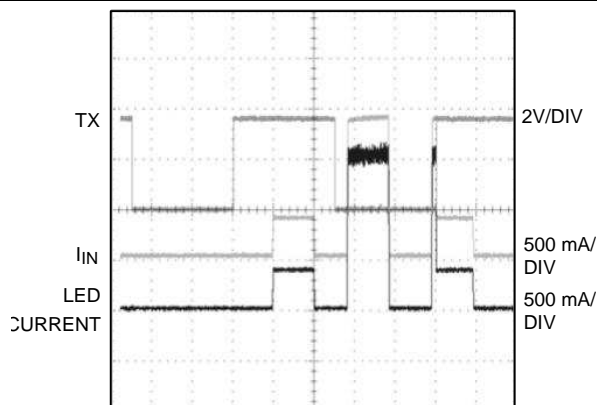

100 ms/DIV

Figure 26. TX Transition Plot Behavior of LED Current Shown on Enabling the Part in a TX Event and Upon TX Interrupting During a Flash

9 Power Supply Recommendations

The LM3642 is designed to operate from an input voltage supply range between 2.5 V and 5.5 V. This input supply must be well regulated and capable to supply the required input current. If the input supply is located far from the LM3642 additional bulk capacitance may be required in addition to the ceramic bypass capacitors.

10 Layout

10.1 Layout Guidelines

The high switching frequency and large switching currents of the LM3642 make the choice of layout important. The following steps should be used as a reference to ensure the device is stable and maintains proper LED current regulation across its intended operating voltage and current range.

1. Place C_{IN} on the top layer (same layer as the LM3642) and as close to the device as possible. The input capacitor conducts the driver currents during the low side MOSFET turn-on and turn-off and can see current spikes over 1 A in amplitude. Connecting the input capacitor through short wide traces to both the IN and GND pins will reduce the inductive voltage spikes that occur during switching and which can corrupt the V_{IN} line.
2. Place C_{OUT} on the top layer (same layer as the LM3642) and as close as possible to the OUT and GND pin. The returns for both C_{IN} and C_{OUT} should come together at one point, and as close to the GND pin as possible. Connecting C_{OUT} through short wide traces will reduce the series inductance on the OUT and GND pins that can corrupt the V_{OUT} and GND line and cause excessive noise in the device and surrounding circuitry.
3. Connect the inductor on the top layer close to the SW pin. There should be a low-impedance connection from the inductor to SW due to the large DC inductor current, and at the same time the area occupied by the SW node should be small so as to reduce the capacitive coupling of the high dV/dt present at SW that can couple into nearby traces.
4. Avoid routing logic traces near the SW node so as to avoid any capacitively coupled voltages from SW onto any high-impedance logic lines such as STROBE, SDA, and SCL. A good approach is to insert an inner layer GND plane underneath the SW node and between any nearby routed traces. This creates a shield from the electric field generated at SW.
5. Terminate the Flash LED cathodes directly to the GND pin of the LM3642. If possible, route the LED returns with a dedicated path so as to keep the high amplitude LED currents out of the GND plane. For Flash LEDs that are routed relatively far away from the LM3642, a good approach is to sandwich the forward and return current paths over the top of each other on two layers. This will help in reducing the inductance of the LED current paths.

11 Device and Documentation Support

11.1 Device Support

11.1.1 Third-Party Products Disclaimer

TI'S PUBLICATION OF INFORMATION REGARDING THIRD-PARTY PRODUCTS OR SERVICES DOES NOT CONSTITUTE AN ENDORSEMENT REGARDING THE SUITABILITY OF SUCH PRODUCTS OR SERVICES OR A WARRANTY, REPRESENTATION OR ENDORSEMENT OF SUCH PRODUCTS OR SERVICES, EITHER ALONE OR IN COMBINATION WITH ANY TI PRODUCT OR SERVICE.

11.2 Documentation Support

11.2.1 Related Documentation

For related documentation, see the following:

Texas Instruments Application Note 1112: *DSBGA Wafer Level Chip Scale Package* ([SNVA009](#)).

11.3 Trademarks

E2E is a trademark of Texas Instruments.

All other trademarks are the property of their respective owners.

11.4 Community Resources

The following links connect to TI community resources. Linked contents are provided "AS IS" by the respective contributors. They do not constitute TI specifications and do not necessarily reflect TI's views; see TI's [Terms of Use](#).

TI E2E™ Online Community *TI's Engineer-to-Engineer (E2E) Community*. Created to foster collaboration among engineers. At [e2e.ti.com](#), you can ask questions, share knowledge, explore ideas and help solve problems with fellow engineers.

Design Support *TI's Design Support* Quickly find helpful E2E forums along with design support tools and contact information for technical support.

11.5 Electrostatic Discharge Caution



This integrated circuit can be damaged by ESD. Texas Instruments recommends that all integrated circuits be handled with appropriate precautions. Failure to observe proper handling and installation procedures can cause damage.

ESD damage can range from subtle performance degradation to complete device failure. Precision integrated circuits may be more susceptible to damage because very small parametric changes could cause the device not to meet its published specifications.

11.6 Glossary

[SLYZ022](#) — *TI Glossary*.

This glossary lists and explains terms, acronyms, and definitions.

12 Mechanical, Packaging, and Orderable Information

The following pages include mechanical, packaging, and orderable information. This information is the most current data available for the designated devices. This data is subject to change without notice and revision of this document. For browser-based versions of this data sheet, refer to the left-hand navigation.

PACKAGING INFORMATION

Orderable Device	Status (1)	Package Type	Package Drawing	Pins	Package Qty	Eco Plan (2)	Lead/Ball Finish (6)	MSL Peak Temp (3)	Op Temp (°C)	Device Marking (4/5)	Samples
LM3642TLE-LT/NOPB	ACTIVE	DSBGA	YZR	9	250	Green (RoHS & no Sb/Br)	SNAGCU	Level-1-260C-UNLIM	-40 to 85	(D2 ~ D4)	Samples
LM3642TLE/NOPB	ACTIVE	DSBGA	YZR	9	250	Green (RoHS & no Sb/Br)	SNAGCU	Level-1-260C-UNLIM	-40 to 85	D2	Samples
LM3642TLX-LT/NOPB	ACTIVE	DSBGA	YZR	9	3000	Green (RoHS & no Sb/Br)	SNAGCU	Level-1-260C-UNLIM	-40 to 85	(D2 ~ D4)	Samples
LM3642TLX/NOPB	ACTIVE	DSBGA	YZR	9	3000	Green (RoHS & no Sb/Br)	SNAGCU	Level-1-260C-UNLIM	-40 to 85	D2	Samples

(1) The marketing status values are defined as follows:

ACTIVE: Product device recommended for new designs.

LIFEBUY: TI has announced that the device will be discontinued, and a lifetime-buy period is in effect.

NRND: Not recommended for new designs. Device is in production to support existing customers, but TI does not recommend using this part in a new design.

PREVIEW: Device has been announced but is not in production. Samples may or may not be available.

OBSELETE: TI has discontinued the production of the device.

(2) Eco Plan - The planned eco-friendly classification: Pb-Free (RoHS), Pb-Free (RoHS Exempt), or Green (RoHS & no Sb/Br) - please check <http://www.ti.com/productcontent> for the latest availability information and additional product content details.

TBD: The Pb-Free/Green conversion plan has not been defined.

Pb-Free (RoHS): TI's terms "Lead-Free" or "Pb-Free" mean semiconductor products that are compatible with the current RoHS requirements for all 6 substances, including the requirement that lead not exceed 0.1% by weight in homogeneous materials. Where designed to be soldered at high temperatures, TI Pb-Free products are suitable for use in specified lead-free processes.

Pb-Free (RoHS Exempt): This component has a RoHS exemption for either 1) lead-based flip-chip solder bumps used between the die and package, or 2) lead-based die adhesive used between the die and leadframe. The component is otherwise considered Pb-Free (RoHS compatible) as defined above.

Green (RoHS & no Sb/Br): TI defines "Green" to mean Pb-Free (RoHS compatible), and free of Bromine (Br) and Antimony (Sb) based flame retardants (Br or Sb do not exceed 0.1% by weight in homogeneous material)

(3) MSL, Peak Temp. - The Moisture Sensitivity Level rating according to the JEDEC industry standard classifications, and peak solder temperature.

(4) There may be additional marking, which relates to the logo, the lot trace code information, or the environmental category on the device.

(5) Multiple Device Markings will be inside parentheses. Only one Device Marking contained in parentheses and separated by a "~" will appear on a device. If a line is indented then it is a continuation of the previous line and the two combined represent the entire Device Marking for that device.

(6) Lead/Ball Finish - Orderable Devices may have multiple material finish options. Finish options are separated by a vertical ruled line. Lead/Ball Finish values may wrap to two lines if the finish value exceeds the maximum column width.

Important Information and Disclaimer: The information provided on this page represents TI's knowledge and belief as of the date that it is provided. TI bases its knowledge and belief on information provided by third parties, and makes no representation or warranty as to the accuracy of such information. Efforts are underway to better integrate information from third parties. TI has taken and continues to take reasonable steps to provide representative and accurate information but may not have conducted destructive testing or chemical analysis on incoming materials and chemicals. TI and TI suppliers consider certain information to be proprietary, and thus CAS numbers and other limited information may not be available for release.

In no event shall TI's liability arising out of such information exceed the total purchase price of the TI part(s) at issue in this document sold by TI to Customer on an annual basis.

TAPE AND REEL INFORMATION

QUADRANT ASSIGNMENTS FOR PIN 1 ORIENTATION IN TAPE

*All dimensions are nominal

Device	Package Type	Package Drawing	Pins	SPQ	Reel Diameter (mm)	Reel Width W1 (mm)	A0 (mm)	B0 (mm)	K0 (mm)	P1 (mm)	W (mm)	Pin1 Quadrant
LM3642TLE-LT/NOPB	DSBGA	YZR	9	250	178.0	8.4	1.78	1.78	0.76	4.0	8.0	Q1
LM3642TLE/NOPB	DSBGA	YZR	9	250	178.0	8.4	1.78	1.78	0.76	4.0	8.0	Q1
LM3642TLX-LT/NOPB	DSBGA	YZR	9	3000	178.0	8.4	1.78	1.78	0.76	4.0	8.0	Q1
LM3642TLX-LT/NOPB	DSBGA	YZR	9	3000	178.0	9.2	1.76	1.81	0.75	4.0	8.0	Q1
LM3642TLX/NOPB	DSBGA	YZR	9	3000	178.0	8.4	1.78	1.78	0.76	4.0	8.0	Q1

TAPE AND REEL BOX DIMENSIONS

*All dimensions are nominal

Device	Package Type	Package Drawing	Pins	SPQ	Length (mm)	Width (mm)	Height (mm)
LM3642TLE-LT/NOPB	DSBGA	YZR	9	250	210.0	185.0	35.0
LM3642TLE/NOPB	DSBGA	YZR	9	250	210.0	185.0	35.0
LM3642TLX-LT/NOPB	DSBGA	YZR	9	3000	210.0	185.0	35.0
LM3642TLX-LT/NOPB	DSBGA	YZR	9	3000	220.0	220.0	35.0
LM3642TLX/NOPB	DSBGA	YZR	9	3000	210.0	185.0	35.0

YZR0009

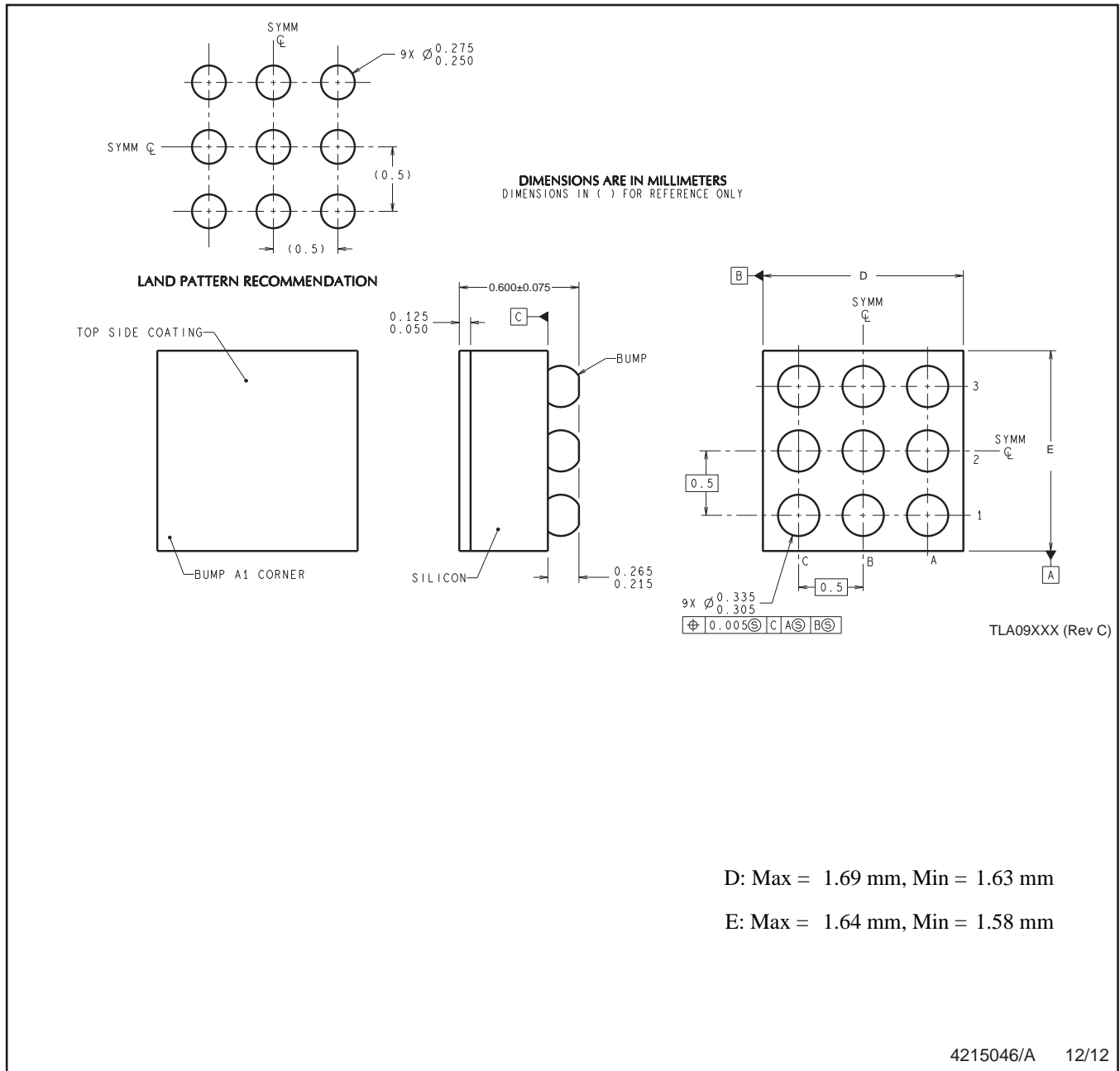

NOTES: A. All linear dimensions are in millimeters. Dimensioning and tolerancing per ASME Y14.5M-1994.
B. This drawing is subject to change without notice.

IMPORTANT NOTICE AND DISCLAIMER

TI PROVIDES TECHNICAL AND RELIABILITY DATA (INCLUDING DATASHEETS), DESIGN RESOURCES (INCLUDING REFERENCE DESIGNS), APPLICATION OR OTHER DESIGN ADVICE, WEB TOOLS, SAFETY INFORMATION, AND OTHER RESOURCES "AS IS" AND WITH ALL FAULTS, AND DISCLAIMS ALL WARRANTIES, EXPRESS AND IMPLIED, INCLUDING WITHOUT LIMITATION ANY IMPLIED WARRANTIES OF MERCHANTABILITY, FITNESS FOR A PARTICULAR PURPOSE OR NON-INFRINGEMENT OF THIRD PARTY INTELLECTUAL PROPERTY RIGHTS.

These resources are intended for skilled developers designing with TI products. You are solely responsible for (1) selecting the appropriate TI products for your application, (2) designing, validating and testing your application, and (3) ensuring your application meets applicable standards, and any other safety, security, or other requirements. These resources are subject to change without notice. TI grants you permission to use these resources only for development of an application that uses the TI products described in the resource. Other reproduction and display of these resources is prohibited. No license is granted to any other TI intellectual property right or to any third party intellectual property right. TI disclaims responsibility for, and you will fully indemnify TI and its representatives against, any claims, damages, costs, losses, and liabilities arising out of your use of these resources.

TI's products are provided subject to TI's Terms of Sale (www.ti.com/legal/termsofsale.html) or other applicable terms available either on ti.com or provided in conjunction with such TI products. TI's provision of these resources does not expand or otherwise alter TI's applicable warranties or warranty disclaimers for TI products.

Mailing Address: Texas Instruments, Post Office Box 655303, Dallas, Texas 75265
Copyright © 2019, Texas Instruments Incorporated

Looking for pricing, stock, or lifecycle information?

Click below to explore more details on WIN SOURCE:

 [View LM3642TLE-LT/NOPB on WIN SOURCE](#)

 [Texas Instruments](#) Information

Optimize Your Supply Chain with WIN SOURCE Solutions

-  Global Sourcing Solution
-  Obsolete Management
-  Cost Control Management
-  Shortage Management
-  Alternative Solution
-  Excess Inventory Management