

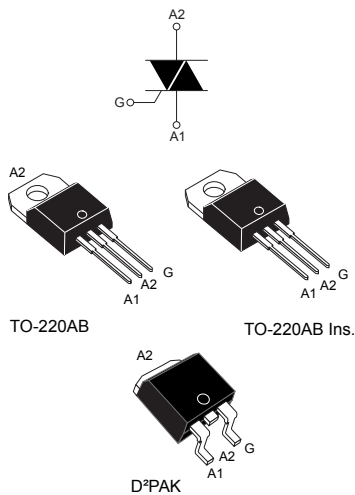

**THE DATASHEET OF
BTB12-800BRG**



12 A Snubberless™, logic level and standard Triacs



Features

- Medium current Triac
- Low thermal resistance with clip bonding
- Low thermal resistance insulation ceramic for insulated BTA
- High commutation (4Q) or very high commutation (3Q) capability
- BTA series UL1557 certified (file ref: 81734)
- Packages are RoHS (2011/65/EU) compliant

Description

Available either in through-hole or surface mount packages, the BTA12, BTB12 and T12xx Triac series are suitable for general purpose mains power AC switching. They can be used as ON/OFF function in applications such as static relays, heating regulation or induction motor starting circuit. They are also recommended for phase control operations in light dimmers and appliance motors speed controllers.

The Snubberless™ versions (W suffix and T12xx) are especially recommended for use on inductive loads, because of their high commutation performance. By using an internal ceramic pad, the Snubberless™ series provide an insulated tab (rated at 2500 V_{RMS}) complying with UL standards (file reference: E81734).

Logic Level BTA12-600TW and BTA12-600SW offer low holding current, ideal to design light dimmers for LED lamps.

Product status link

[BTA12](#)

[BTB12](#)

[T1205](#)

[T1210](#)

[T1235](#)

[T1250](#)

Product summary

$I_{T(RMS)}$	12 A
V_{DRM}/V_{RRM}	600 and 800 V
$I_{GT(Snubberless)}$	5 / 10 / 35 / 50 mA
$I_{GT(standard)}$	25 / 50

1 Characteristics

Table 1. Absolute maximum ratings ($T_j = 25\text{ °C}$ unless otherwise stated)

Symbol	Parameter			Value	Unit
$I_{T(RMS)}$	RMS on-state current (full sine wave)	TO-220AB, D ² PAK	$T_c = 105\text{ °C}$	12	A
		TO-220AB Ins.	$T_c = 90\text{ °C}$		
I_{TSM}	Non repetitive surge peak on-state current (full cycle, T_j initial = 25 °C)	f = 50 Hz	t = 20 ms	120	A
		f = 60 Hz	$t_p = 16.7\text{ ms}$	126	
I^2t	I^2t value for fusing		$t_p = 10\text{ ms}$	78	A ² s
dI/dt	Critical rate of rise of on-state current $I_G = 2 \times I_{GT}$, tr ≤ 100 ns	f = 120 Hz	$T_j = 125\text{ °C}$	50	A/μs
V_{DSM}/V_{RSM}	Non repetitive surge peak off-state voltage	$t_p = 10\text{ ms}$	$T_j = 25\text{ °C}$	V_{DRM} / V_{RRM}^+ 100	V
I_{GM}	Peak gate current	$t_p = 20\text{ μs}$	$T_j = 125\text{ °C}$	4	A
$P_{G(AV)}$	Average gate power dissipation		$T_j = 125\text{ °C}$	1	W
T_{stg}	Storage junction temperature range			-40 to +150	°C
T_j	Operating junction temperature range			-40 to +125	°C

Table 2. Electrical characteristics ($T_j = 25\text{ °C}$, unless otherwise specified) - Snubberless™ and logic level (3 quadrants)

Symbol	Parameter	Quadrant		T1205	T1210	T1235	T1250	Unit
				BTB12-TW BTA12-TW	BTB12-SW BTA12-SW	BTB12-CW BTA12-CW	BTB12-BW BTA12-BW	
$I_{GT}^{(1)}$	$V_D = 12\text{ V}$, $R_L = 30\text{ Ω}$	I - II - III	Max.	5	10	35	50	mA
V_{GT}		I - II - III	Max.	1.3				V
V_{GD}	$V_D = V_{DRM}$, $R_L = 3.3\text{ kΩ}$, $T_j = 125\text{ °C}$	I - II - III	Min.	0.2				V
$I_H^{(2)}$	$I_T = 100\text{ mA}$	I - II - III	Max.	10	15	35	50	mA
$I_L^{(2)}$	$I_G = 1.2 \times I_{GT}$	I - III	Max.	10	25	50	70	mA
		II	Max.	15	30	60	80	
$dV/dt^{(2)}$	$V_D = 67\% V_{DRM}$, gate open, $T_j = 125\text{ °C}$		Max.	20	40	500	1000	V/μs
$(dI/dt)_c^{(2)}$	$(dV/dt)_c = 0.1\text{ V/μs}$, $T_j = 125\text{ °C}$		Min.	3.5	6.5			A/ms
	$(dV/dt)_c = 10\text{ V/μs}$, $T_j = 125\text{ °C}$		Min.	1.0	2.9			
	Without snubber, $T_j = 125\text{ °C}$		Min.			6.5	12	

1. Minimum I_{GT} is guaranteed at 5 % of I_{GT} max.
2. For both polarities of A2 referenced to A1

Table 3. Electrical characteristics ($T_j = 25\text{ }^\circ\text{C}$, unless otherwise specified) - Standard Triac (4 quadrants)

Symbol	Parameter	Quadrant		Value		Unit
				C	B	
$I_{GT}^{(1)}$	$V_D = 12\text{ V}$, $R_L = 30\ \Omega$	I - II - III	Max.	25	50	mA
		IV		50	100	
V_{GT}		All	Max.	1.3		V
V_{GD}	$V_D = V_{DRM}$, $R_L = 33\text{ k}\Omega$, $T_j = 125\text{ }^\circ\text{C}$	All	Min.	0.2		V
$I_H^{(2)}$	$I_T = 500\text{ mA}$	I - II - III	Max.	25	50	mA
I_L	$I_G = 1.2\ I_{GT}$	I - III - IV	Max.	40	50	mA
		II		80	100	
$dV/dt^{(2)}$	$V_D = 67\%$ V_{DRM} gate open, $T_j = 125\text{ }^\circ\text{C}$		Min.	200	400	V/ μs
$(dV/dt)_C^{(2)}$	$(dI/dt)_C = 5.3\text{ A/ms}$, $T_j = 125\text{ }^\circ\text{C}$		Min.	5	10	V/ μs

1. Minimum I_{GT} is guaranteed at 5 % of I_{GT} max.
2. For both polarities of A2 referenced to A1

Table 4. Static electrical characteristics

Symbol	Test conditions			Value	Unit
$V_{TM}^{(1)}$	$I_{TM} = 17\text{ A}$, $t_p = 380\ \mu\text{s}$	$T_j = 25\text{ }^\circ\text{C}$	Max.	1.55	V
$V_{TO}^{(1)}$	threshold on-state voltage	$T_j = 125\text{ }^\circ\text{C}$	Max.	0.85	V
$R_D^{(1)}$	Dynamic resistance	$T_j = 125\text{ }^\circ\text{C}$	Max.	35	m Ω
I_{DRM} I_{RRM}	$V_{DRM} = V_{RRM}$	$T_j = 25\text{ }^\circ\text{C}$	Max.	5	μA
		$T_j = 125\text{ }^\circ\text{C}$	Max.	1	mA

1. For both polarities of A2 referenced to A1

Table 5. Thermal resistance

Symbol	Parameter			Value	Unit	
$R_{th(j-c)}$	Max. junction to case thermal resistance (AC)		D ² PAK / TO-220AB	Max.	1.4	$^\circ\text{C/W}$
			TO-220AB insulated	Max.	2.3	
$R_{th(j-a)}$	Junction to ambient	$S = 2\text{ cm}^2$ ⁽¹⁾	D ² PAK	Typ.	45	$^\circ\text{C/W}$
	Junction to ambient		TO-220AB / TO-220AB insulated	Typ.	60	

1. S = Copper surface under tab.

1.1 Characteristics (curves)

Figure 1. Maximum power dissipation versus on-state RMS current (full cycle)

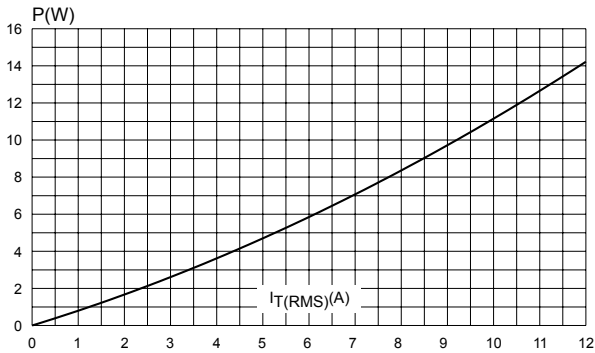

Figure 2. RMS on-state current cycle versus case temperature (full cycle)

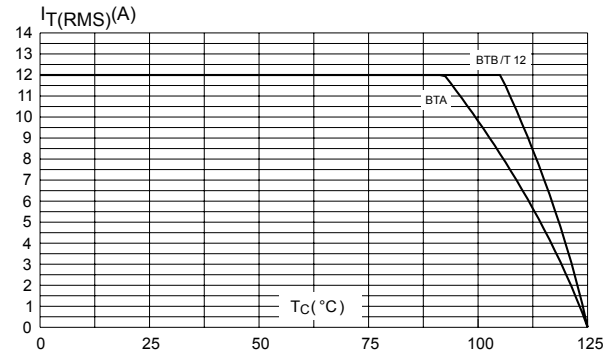

Figure 3. RMS on-state current versus ambient temperature (printed circuit board FR4, copper thickness: 35 μm) (full cycle)

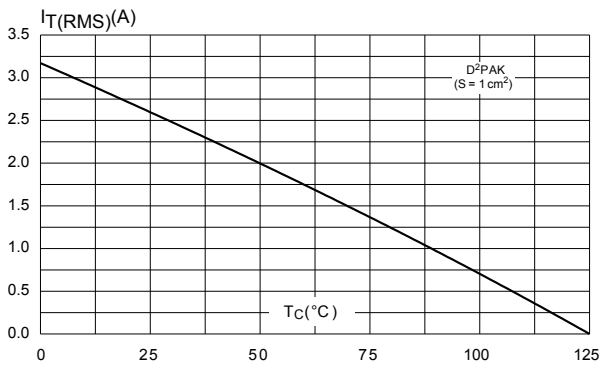

Figure 4. Relative variation of thermal impedance versus pulse duration

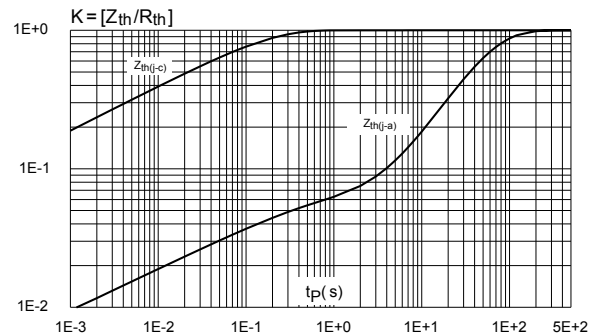

Figure 5. On-state characteristics (maximum values)

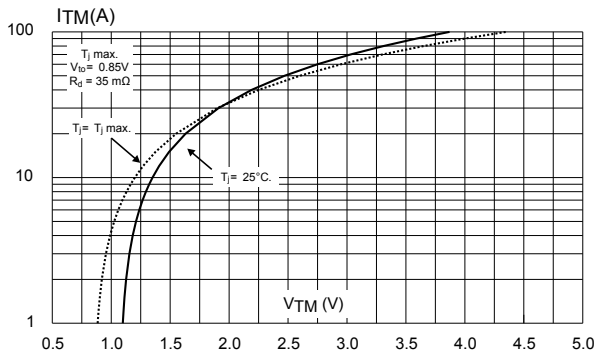

Figure 6. Surge peak on-state current versus number of cycles

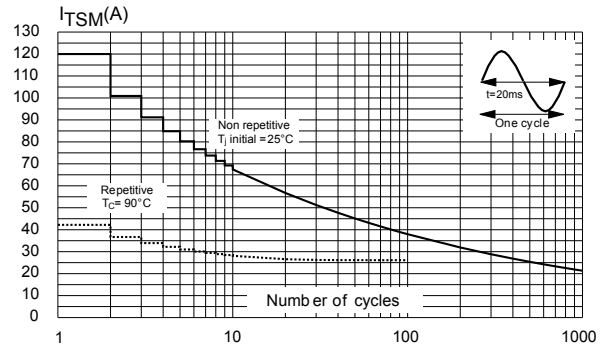

Figure 7. Non repetitive surge peak on-state current for a sinusoidal pulse

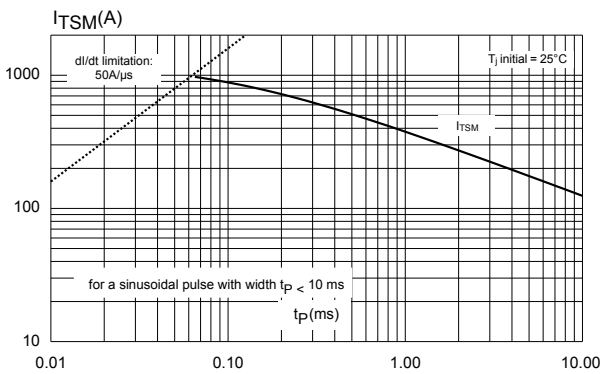

Figure 8. Relative variation of gate trigger current holding current and latching current versus junction temperature (typical values)

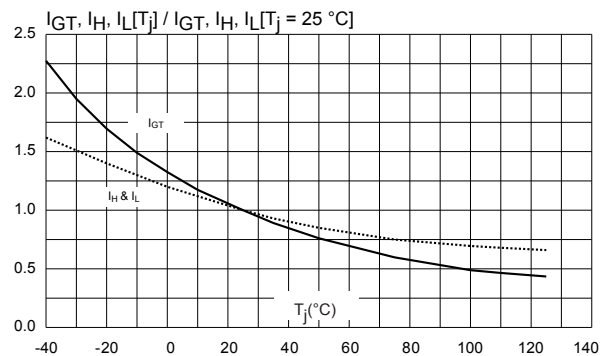

Figure 9. Relative variation of critical rate of decrease of main current versus (dV/dt)_c (typical values)

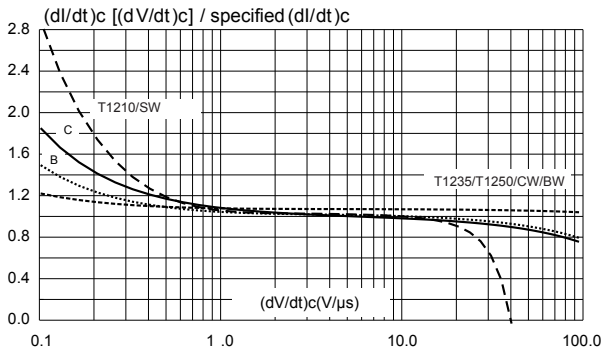

Figure 10. Relative variation of critical rate of decrease of main current versus (dV/dt)_c (typical values)(TW)

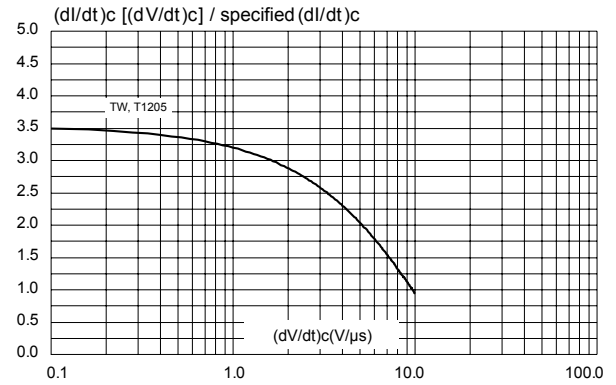

Figure 11. Relative variation of critical rate of decrease of main current versus junction temperature

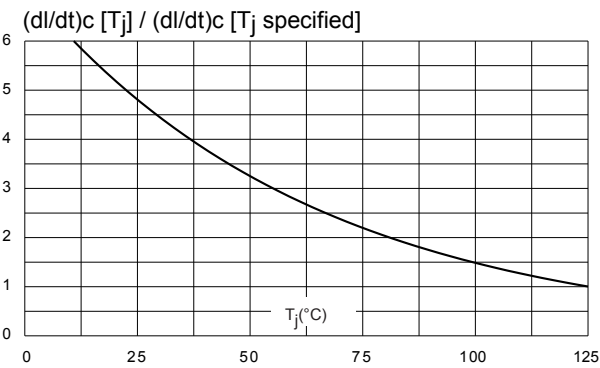
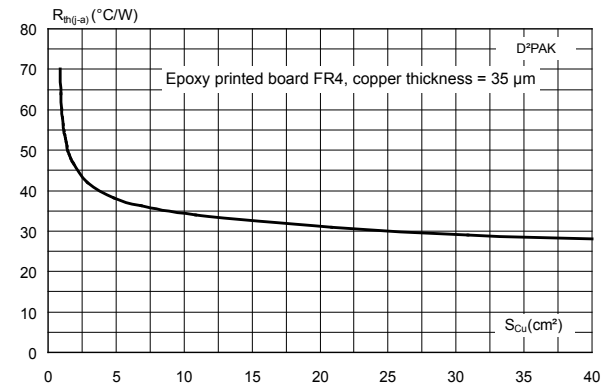

Figure 12. D²PAK thermal resistance junction to ambient versus copper surface under tab



2 Package information

In order to meet environmental requirements, ST offers these devices in different grades of **ECOPACK®** packages, depending on their level of environmental compliance. ECOPACK® specifications, grade definitions and product status are available at: www.st.com. ECOPACK® is an ST trademark.

2.1 D²PAK package information

- ECOPACK2® compliant
- Lead-free package leads finishing
- Molding compound resin is halogen-free and meets UL standard level V0

Figure 13. D²PAK package outline

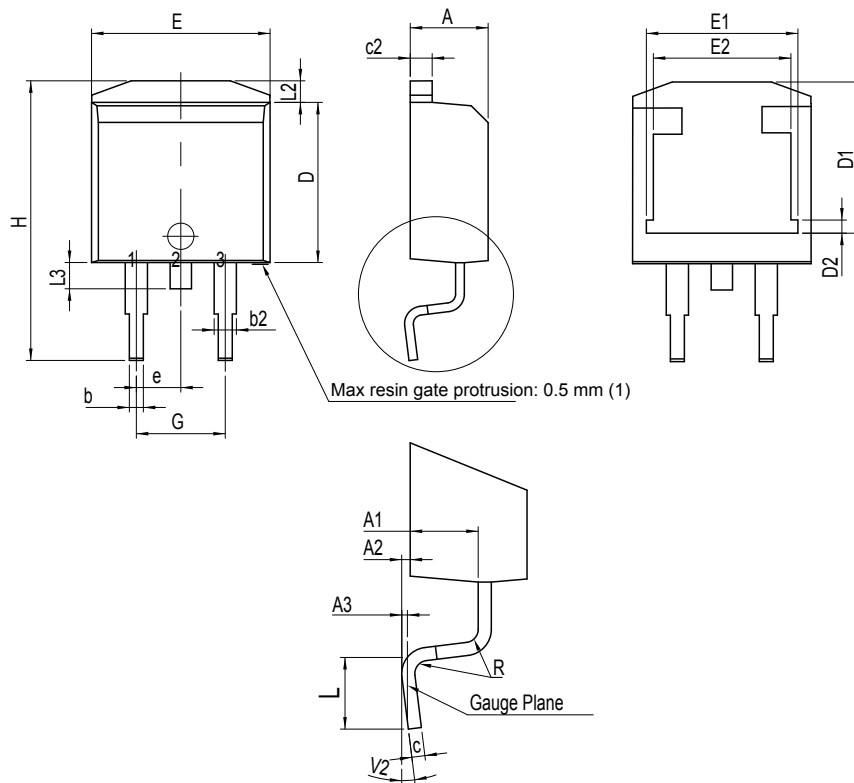

(1) Resin gate is accepted in each of position shown on the drawing, or their symmetrical.

Table 6. D²PAK package mechanical data

Ref.	Dimensions					
	Millimeters			Inches ⁽¹⁾		
	Min.	Typ.	Max.	Min.	Typ.	Max.
A	4.30		4.60	0.1693		0.1811
A1	2.49		2.69	0.0980		0.1059
A2	0.03		0.23	0.0012		0.0091
A3		0.25			0.0098	
b	0.70		0.93	0.0276		0.0366
b2	1.25		1.7	0.0492		0.0669
c	0.45		0.60	0.0177		0.0236
c2	1.21		1.36	0.0476		0.0535
D	8.95		9.35	0.3524		0.3681
D1	7.50		8.00	0.2953		0.3150
D2	1.30		1.70	0.0512		0.0669
e	2.54			0.1		
E	10.00		10.28	0.3937		0.4047
E1	8.30		8.70	0.3268		0.3425
E2	6.85		7.25	0.2697		0.2854
G	4.88		5.28	0.1921		0.2079
H	15		15.85	0.5906		0.6240
L	1.78		2.28	0.0701		0.0898
L2	1.27		1.40	0.0500		0.0551
L3	1.40		1.75	0.0551		0.0689
R		0.40			0.0157	
V2	0°		8°	0°		8°

1. Dimensions in inches are given for reference only

Figure 14. D²PAK recommended footprint (dimensions are in mm)

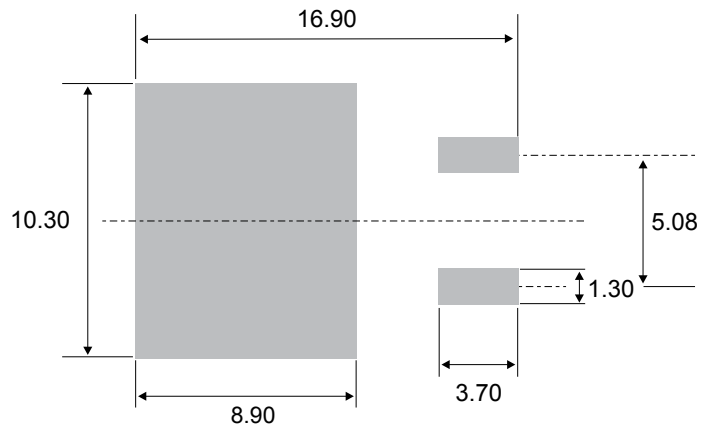

2.2 TO-220AB insulated package information

- Epoxy meets UL 94,V0
- Cooling method: by conduction (C)
- Recommended torque value: 0.55 N·m
- Maximum torque value: 0.70 N·m

Figure 15. TO-220AB insulated and non insulated package outline

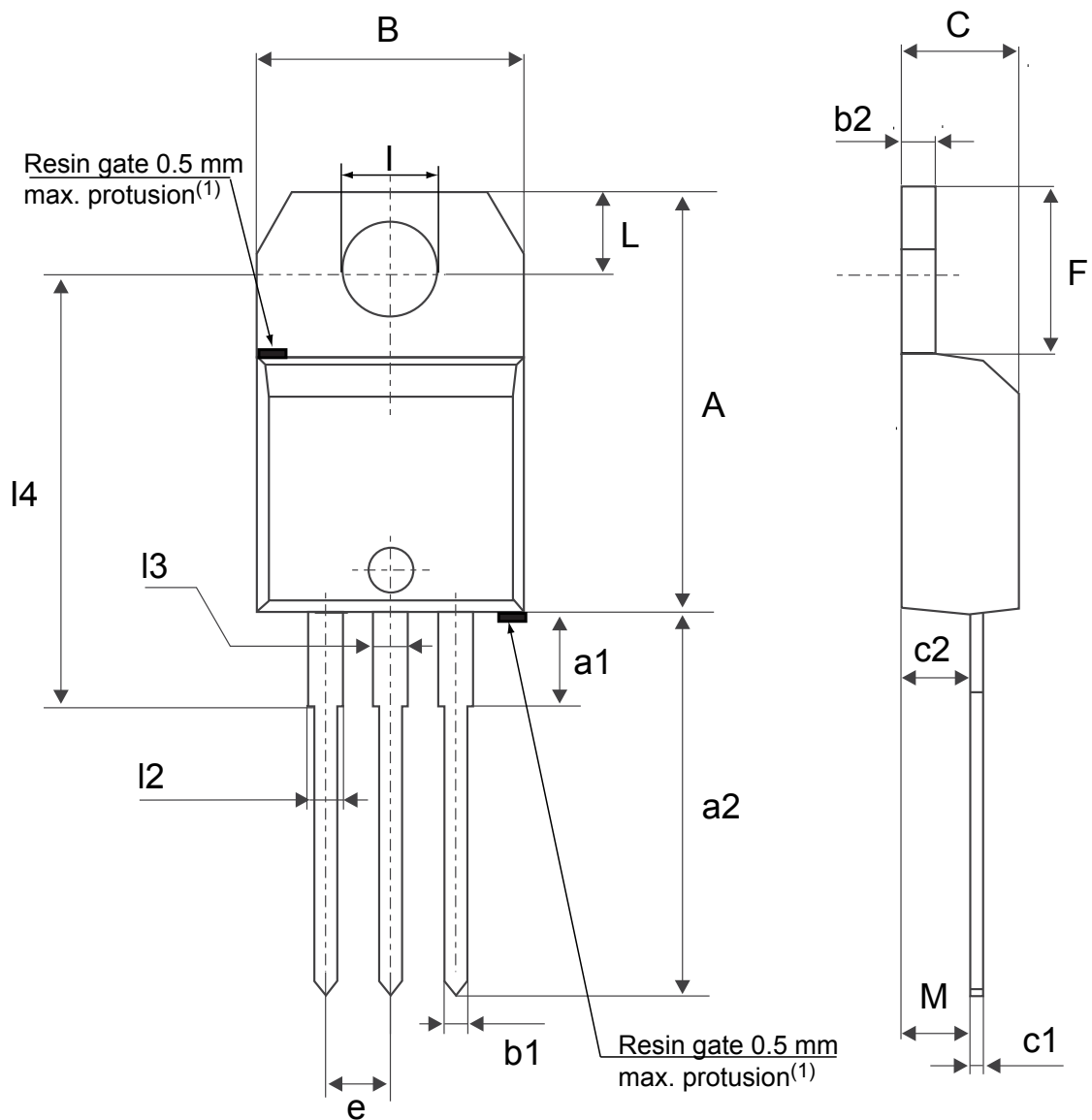

(1) Resin gate position accepted in one of the two positions or in the symmetrical opposites.

Table 7. TO-220AB insulated and non insulated package mechanical data

Ref.	Dimensions					
	Millimeters			Inches ⁽¹⁾		
	Min.	Typ.	Max.	Min.	Typ.	Max.
A	15.20		15.90	0.5984		0.6260
a1		3.75			0.1476	
a2	13.00		14.00	0.5118		0.5512
B	10.00		10.40	0.3937		0.4094
b1	0.61		0.88	0.0240		0.0346
b2	1.23		1.32	0.0484		0.0520
C	4.40		4.60	0.1732		0.1811
c1	0.49		0.70	0.0193		0.0276
c2	2.40		2.72	0.0945		0.1071
e	2.40		2.70	0.0945		0.1063
F	6.20		6.60	0.2441		0.2598
I	3.73		3.88	0.1469		0.1528
L	2.65		2.95	0.1043		0.1161
I2	1.14		1.70	0.0449		0.0669
I3	1.14		1.70	0.0449		0.0669
I4	15.80	16.40	16.80	0.6220	0.6457	0.6614
M		2.6			0.1024	

1. Inch dimensions are for reference only.

3 Ordering information

Figure 16. Ordering information scheme (BTA12 and BTB12 series)

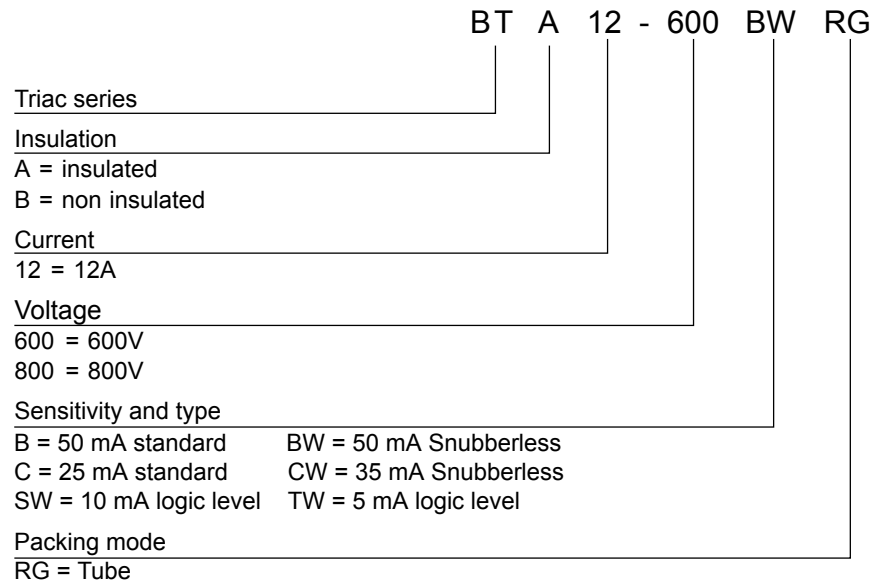

Figure 17. Ordering information scheme (T12 series)

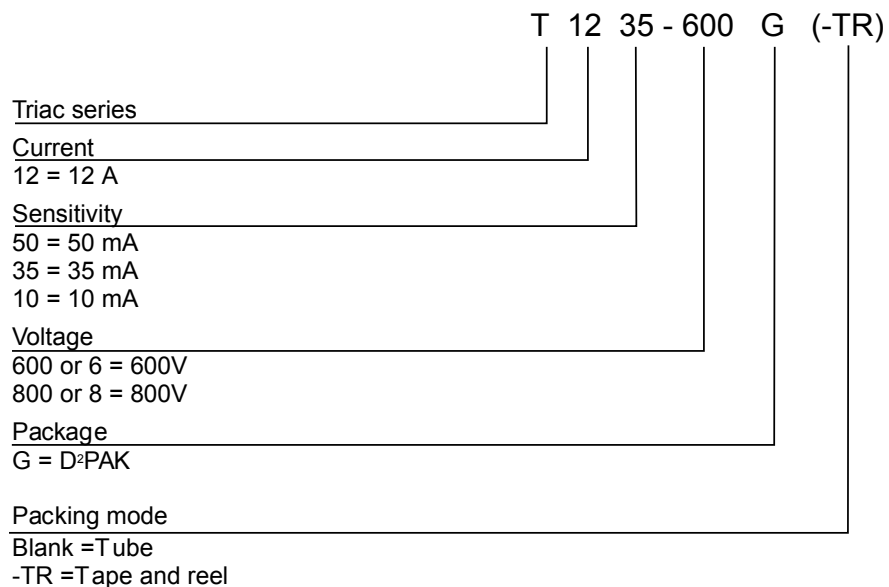

Table 8. Product selector

Part number	Voltage (xxx)		Sensitivity	Type	Package
	600	800			
BTB12-600C	X		25 mA	Standard	TO-220AB
BTB12-600B	X		50 mA	Standard	TO-220AB
BTB12-600TW	X		5 mA	Snubberless™	TO-220AB
BTB12-600SW	X		10 mA	Snubberless™	TO-220AB
BTB12-xxxCW	X	X	35 mA	Snubberless™	TO-220AB
BTB12-600BW	X		50 mA	Snubberless™	TO-220AB
BTA12-600C	X		25 mA	Standard	TO-220AB Ins.
BTA12-xxxB	X	X	50 mA	Standard	TO-220AB Ins.
BTA12-600TW	X		5 mA	Snubberless™	TO-220AB Ins.
BTA12-xxxSW	X	X	10 mA	Snubberless™	TO-220AB Ins.
BTA12-xxxCW	X	X	35 mA	Snubberless™	TO-220AB Ins.
BTA12-xxxBW	X	X	50 mA	Snubberless™	TO-220AB Ins.
T1205-600G	X		5 mA	Snubberless™	D ² PAK
T1210-6G	X		10 mA	Snubberless™	D ² PAK
T1210-800G		X	10 mA	Snubberless™	D ² PAK
T1235-xxxG	X	X	35 mA	Snubberless™	D ² PAK
T1250-600G	X		50 mA	Snubberless™	D ² PAK

Table 9. Ordering information

Order code	Marking	Package	Weight	Base qty.	Delivery mode
BTA12-600BRG	BTA12-600B	TO-220AB Ins.	1.9 g	50	Tube
BTA12-600BWRG	BTA12-600BW				
BTA12-600CRG	BTA12-600C				
BTA12-600CWRG	BTA12-600CW				
BTA12-600SWRG	BTA12-600SW				
BTA12-600TWRG	BTA12-600TW				
BTA12-800BRG	BTA12-800B				
BTA12-800BWRG	BTA12-800BW				
BTA12-800CWRG	BTA12-800CW				
BTA12-800SWRG	BTA12-800SW				
BTB12-600BRG	BTB12-600B	TO-220AB			
BTB12-600BWRG	BTB12-600BW				
BTB12-600CRG	BTB12-600C				
BTB12-600CWRG	BTB12-600CW				
BTB12-600SWRG	BTB12-600SW				
BTB12-600TWRG	BTB12-600TW				
BTB12-800CWRG	BTB12-800CW				
T1205-600G-TR	T1205-600G	D ² PAK	1.38 g	1000	Tape and reel 13"
T1210-6G-TR	T1210-6G				
T1210-800G-TR	T1210-800G				
T1235-600G-TR	T1235-600G				
T1235-800G-TR	T1235-800G				
T1250-600G-TR	T1250-600G				
T1210-6G	T1210-6G			50	Tube
T1235-600G	T1235-600G				

Table 10. Document revision history

Date	Revision	Changes
Sep-2002	6A	Last update.
15-Mar-2005	7	1. I2PAK package added. 2. TO-220AB delivery mode changed from bulk to tube.
27-May-2005	8	T1210 added.
28-Sep-2007	9	Reformatted to current standards. T1250 added.
02-Feb-2017	10	Removed I ² PAK package. Updated Figure 7: "Non-repetitive surge peak on-state current" and Table 9: "Product selector" and Table 10: "Ordering information".
9-Aug-2018	11	Updated D ² PAK package information and Figure 10 . Updated Section Product status / summary .
07-Feb-2019	12	Updated links syntax.

IMPORTANT NOTICE – PLEASE READ CAREFULLY

STMicroelectronics NV and its subsidiaries (“ST”) reserve the right to make changes, corrections, enhancements, modifications, and improvements to ST products and/or to this document at any time without notice. Purchasers should obtain the latest relevant information on ST products before placing orders. ST products are sold pursuant to ST’s terms and conditions of sale in place at the time of order acknowledgement.

Purchasers are solely responsible for the choice, selection, and use of ST products and ST assumes no liability for application assistance or the design of Purchasers’ products.

No license, express or implied, to any intellectual property right is granted by ST herein.

Resale of ST products with provisions different from the information set forth herein shall void any warranty granted by ST for such product.



ST and the ST logo are trademarks of ST. All other product or service names are the property of their respective owners.

Information in this document supersedes and replaces information previously supplied in any prior versions of this document.

© 2019 STMicroelectronics – All rights reserved

Looking for pricing, stock, or lifecycle information?

Click below to explore more details on WIN SOURCE:

-  [View BTB12-800BRG on WIN SOURCE](#)
-  [STMicroelectronics Information](#)

Optimize Your Supply Chain with WIN SOURCE Solutions

-  Global Sourcing Solution
-  Obsolete Management
-  Cost Control Management
-  Shortage Management
-  Alternative Solution
-  Excess Inventory Management