

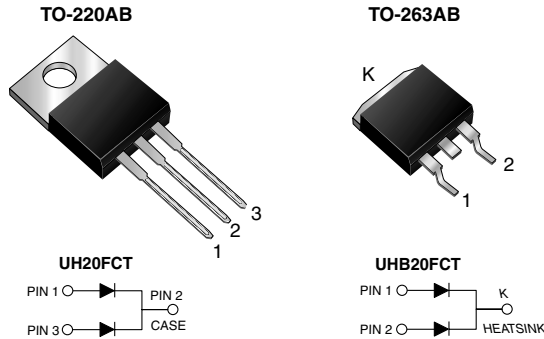

**THE DATASHEET OF
UH20FCT-E3/4W**



Dual Common-Cathode Ultrafast Recovery Rectifier



FEATURES

- Oxide planar chip junction
- Ultrafast recovery times
- Soft recovery characteristics
- Low switching losses, high efficiency
- High forward surge capability
- Meets MSL level 1, per J-STD-020, LF maximum peak of 245 °C (for TO-263AB package)
- Solder dip 260 °C, 40 s (for TO-220AB package)
- Component in accordance to RoHS 2002/95/EC and WEEE 2002/96/EC



RoHS
COMPLIANT

TYPICAL APPLICATIONS

For use in high frequency power factor correctors, switching mode power supplies, freewheeling diodes and secondary dc-to-dc rectification application.

MECHANICAL DATA

Case: TO-220AB and TO-263AB

Epoxy meets UL 94V-0 flammability rating

Terminals: Matte tin plated leads, solderable per J-STD-002 and JESD22-B102

E3 suffix for consumer grade, meets JESD 201 class 1A whisker test

Polarity: As marked

Mounting Torque: 10 in-lbs maximum

PRIMARY CHARACTERISTICS	
$I_{F(AV)}$	10 A x 2
V_{RRM}	300 V
I_{FSM}	180 A
t_{rr}	25 ns
V_F	0.83 V
T_J max.	175 °C

MAXIMUM RATINGS ($T_A = 25\text{ °C}$ unless otherwise noted)				
PARAMETER	SYMBOL	UH20FCT	UHB20FCT	UNIT
Maximum repetitive peak reverse voltage	V_{RRM}	300		V
Maximum average forward rectified current (see Fig.1)	$I_{F(AV)}$	20	10	A
Peak forward surge current 8.3 ms single half sine-wave superimposed on rated load	I_{FSM}	180		A
Operating junction and storage temperature range	T_J, T_{STG}	- 55 to + 175		°C

ELECTRICAL CHARACTERISTICS ($T_A = 25\text{ °C}$ unless otherwise noted)						
PARAMETER	TEST CONDITIONS		SYMBOL	TYP.	MAX.	UNIT
Maximum instantaneous forward voltage per diode ⁽¹⁾	$I_F = 5.0\text{ A}$	$T_J = 25\text{ °C}$	V_F	0.96	-	V
	$I_F = 5.0\text{ A}$	$T_J = 125\text{ °C}$		0.77	-	
	$I_F = 10\text{ A}$	$T_J = 25\text{ °C}$		1.0	1.2	
	$I_F = 10\text{ A}$	$T_J = 125\text{ °C}$		0.83	0.90	



ELECTRICAL CHARACTERISTICS (T _A = 25 °C unless otherwise noted)						
PARAMETER	TEST CONDITIONS		SYMBOL	TYP.	MAX.	UNIT
Maximum reverse current per diode ⁽²⁾	V _R = 300 V	T _J = 25 °C T _J = 125 °C	I _R	0.5 25	5 150	μA
Maximum reverse recovery time	I _F = 0.5 A, I _R = 1.0 A, I _{rr} = 0.25 A		t _{rr}	20	25	ns
Maximum reverse recovery time per diode	I _F = 1.0 A, dI/dt = 50 A/μs, V _R = 30 V, I _{rr} = 0.1 I _{RM}		t _{rr}	28	35	ns
Typical softness factor (tb/ta)	I _F = 10 A, dI/dt = 200 A/μs, V _R = 200 V, T _J = 125 °C per diode		S	0.36	-	-
Typical reverse recovery current			I _{RM}	7.0	-	A
Typical stored charge			Q _{rr}	160	-	nC
Typical forward recovery time per diode	I _F = 10 A, dI/dt = 80 A/μs, V _{FR} = 1.1 x V _{F max.}		t _{fr}	150	-	ns

Notes:

- (1) Pulse test: 300 μs pulse width, 1 % duty cycle
- (2) Pulse test: Pulse width ≤ 40 ms

THERMAL CHARACTERISTICS (T _A = 25 °C unless otherwise noted)				
PARAMETER	SYMBOL	UH20FCT	UHB20FCT	UNIT
Typical thermal resistance per diode	R _{θJC}	2.0	2.0	°C/W

ORDERING INFORMATION					
PACKAGE	PREFERRED P/N	UNIT WEIGHT (g)	PACKAGE CODE	BASE QUANTITY	DELIVERY MODE
TO-220AB	UH20FCT-E3/4W	1.88	4W	50/tube	Tube
TO-263AB	UHB20FCT-E3/4W	1.38	4W	50/tube	Tube
TO-263AB	UHB20FCT-E3/8W	1.38	8W	800/reel	Tape and reel

RATINGS AND CHARACTERISTICS CURVES

(T_A = 25 °C unless otherwise noted)

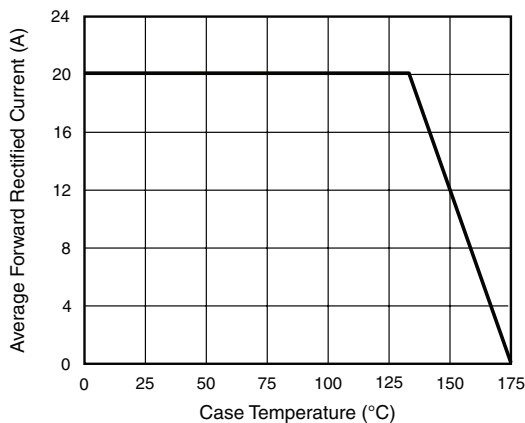

Figure 1. Maximum Forward Current Derating Curve

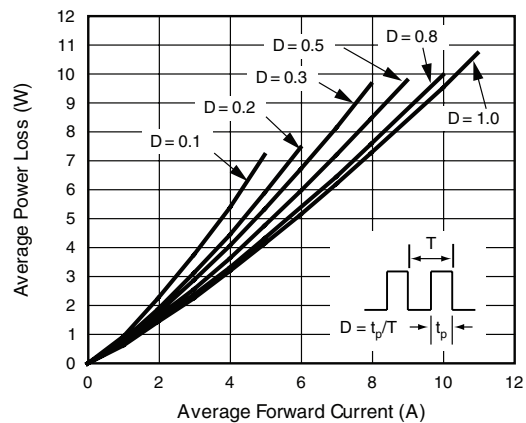

Figure 2. Forward Power Loss Characteristics Per Diode

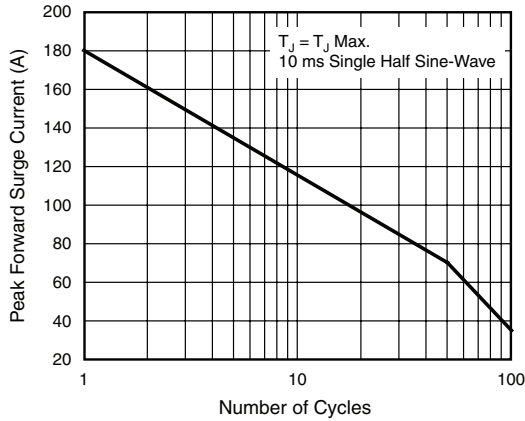

Figure 3. Maximum Non-Repetitive Peak Forward Surge Current Per Diode

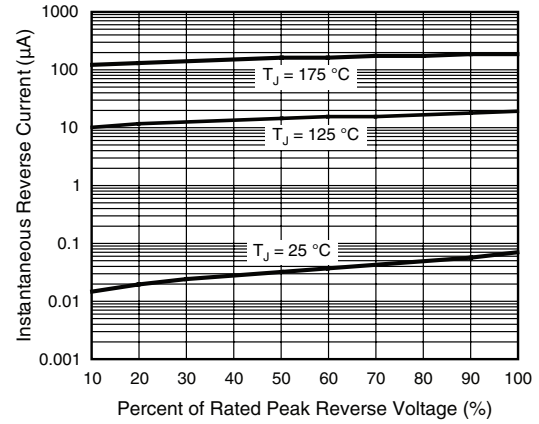

Figure 5. Typical Reverse Leakage Characteristics Per Diode

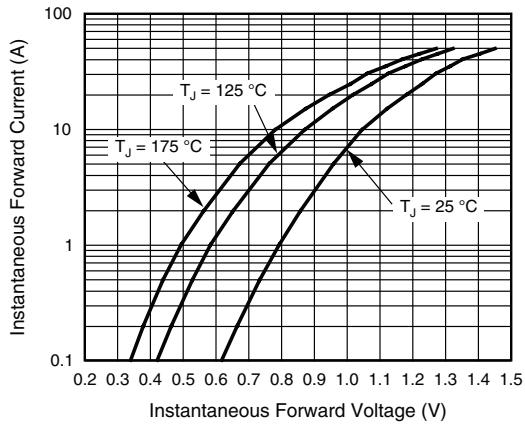

Figure 4. Typical Instantaneous Forward Characteristics Per Diode

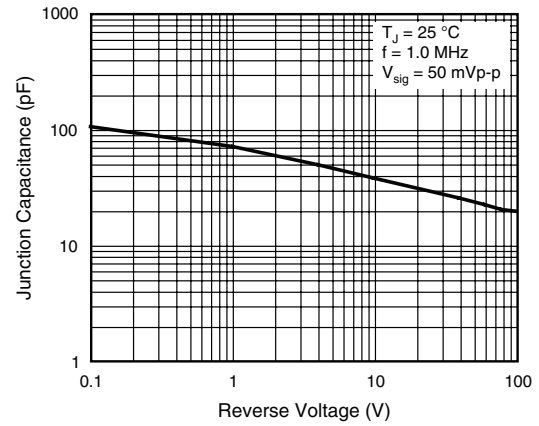
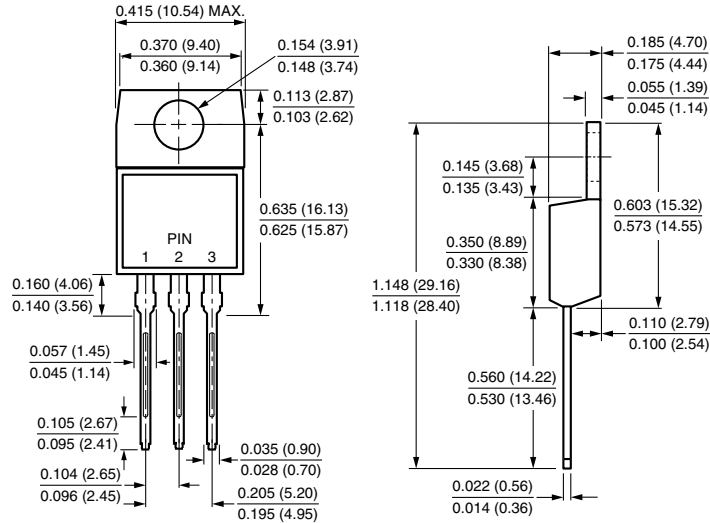

Figure 6. Typical Junction Capacitance Per Diode



PACKAGE OUTLINE DIMENSIONS in inches (millimeters)

TO-220AB



TO-263AB

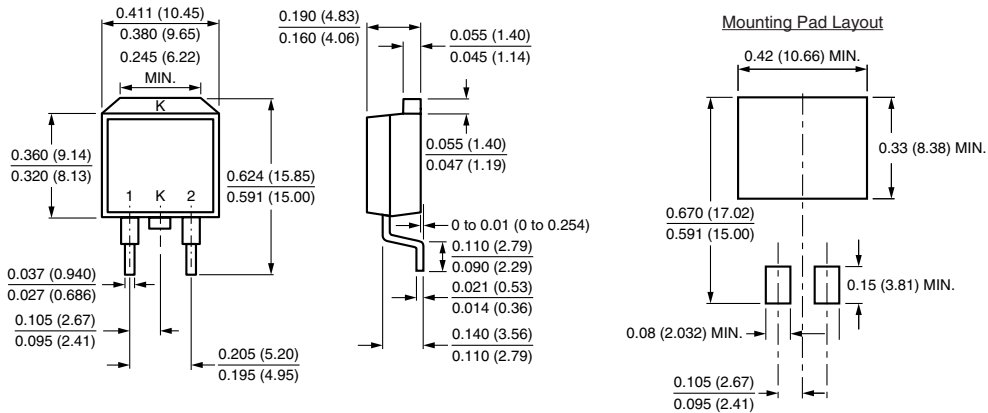



Disclaimer

ALL PRODUCT, PRODUCT SPECIFICATIONS AND DATA ARE SUBJECT TO CHANGE WITHOUT NOTICE TO IMPROVE RELIABILITY, FUNCTION OR DESIGN OR OTHERWISE.

Vishay Intertechnology, Inc., its affiliates, agents, and employees, and all persons acting on its or their behalf (collectively, "Vishay"), disclaim any and all liability for any errors, inaccuracies or incompleteness contained in any datasheet or in any other disclosure relating to any product.

Vishay makes no warranty, representation or guarantee regarding the suitability of the products for any particular purpose or the continuing production of any product. To the maximum extent permitted by applicable law, Vishay disclaims (i) any and all liability arising out of the application or use of any product, (ii) any and all liability, including without limitation special, consequential or incidental damages, and (iii) any and all implied warranties, including warranties of fitness for particular purpose, non-infringement and merchantability.

Statements regarding the suitability of products for certain types of applications are based on Vishay's knowledge of typical requirements that are often placed on Vishay products in generic applications. Such statements are not binding statements about the suitability of products for a particular application. It is the customer's responsibility to validate that a particular product with the properties described in the product specification is suitable for use in a particular application. Parameters provided in datasheets and/or specifications may vary in different applications and performance may vary over time. All operating parameters, including typical parameters, must be validated for each customer application by the customer's technical experts. Product specifications do not expand or otherwise modify Vishay's terms and conditions of purchase, including but not limited to the warranty expressed therein.

Except as expressly indicated in writing, Vishay products are not designed for use in medical, life-saving, or life-sustaining applications or for any other application in which the failure of the Vishay product could result in personal injury or death. Customers using or selling Vishay products not expressly indicated for use in such applications do so at their own risk. Please contact authorized Vishay personnel to obtain written terms and conditions regarding products designed for such applications.

No license, express or implied, by estoppel or otherwise, to any intellectual property rights is granted by this document or by any conduct of Vishay. Product names and markings noted herein may be trademarks of their respective owners.

Material Category Policy

Vishay Intertechnology, Inc. hereby certifies that all its products that are identified as RoHS-Compliant fulfill the definitions and restrictions defined under Directive 2011/65/EU of The European Parliament and of the Council of June 8, 2011 on the restriction of the use of certain hazardous substances in electrical and electronic equipment (EEE) - recast, unless otherwise specified as non-compliant.

Please note that some Vishay documentation may still make reference to RoHS Directive 2002/95/EC. We confirm that all the products identified as being compliant to Directive 2002/95/EC conform to Directive 2011/65/EU.

Vishay Intertechnology, Inc. hereby certifies that all its products that are identified as Halogen-Free follow Halogen-Free requirements as per JEDEC JS709A standards. Please note that some Vishay documentation may still make reference to the IEC 61249-2-21 definition. We confirm that all the products identified as being compliant to IEC 61249-2-21 conform to JEDEC JS709A standards.

Looking for pricing, stock, or lifecycle information?

Click below to explore more details on WIN SOURCE:

 [View UH20FCT-E3/4W on WIN SOURCE](#)

 [Vishay Information](#)

Optimize Your Supply Chain with WIN SOURCE Solutions

-  Global Sourcing Solution
-  Obsolete Management
-  Cost Control Management
-  Shortage Management
-  Alternative Solution
-  Excess Inventory Management