



**THE DATASHEET OF
P6KE520CA-HF**



P6KE-HF Series

Breakdown Voltage: 6.8 to 600 Volts

Peak Pulse Power: 600 Watts

RoHS Device

Halogen Free



Features

- Glass passivated chip.
- 600W peak pulse power capability with a 10/1000 μ s waveform, repetitive rate (duty cycle):0.01%
- Low leakage.
- Uni and Bidirectional unit.
- Excellent clamping capability.
- Very fast response time.
- UL recognized file # E349157  Range: P6KE6.8(C)A thru. P6KE47(C)A

Mechanical Data

- Case: Molded plastic DO-15.
- Epoxy: UL 94V-0 rate flame retardant.
- Lead: Solderable per MIL-STD-202, method 208 guaranteed.
- Polarity: Color band denotes cathode end except Bipolar.
- Mounting position: Any.
- Weight: 0.402 gram (approx.)

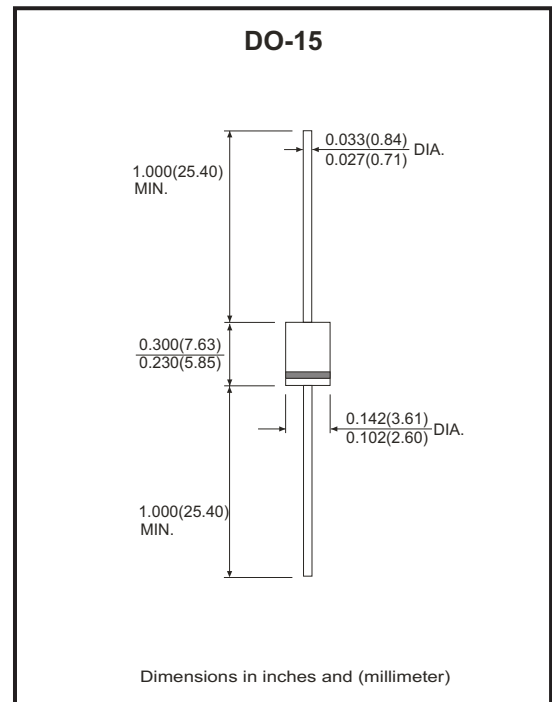

Maximum Ratings (TA=25°C unless otherwise noted)

Parameter	Symbol	Value	Unit
Peak power dissipation with a 10/1000 μ s waveform (Note 1)	PPP	600	W
Peak pulse current with a 10/1000 μ s waveform (Note 1)	I _{PP}	See Next Table	A
Power dissipation on infinite heatsink at T _L =75°C	P _D	5.0	W
Peak forward surge current, 8.3ms single half sine-wave unidirectional only (Note 2)	I _{FSM}	100	A
Maximum instantaneous forward voltage at 50 A for unidirectional only (Note 3)	V _F	3.5/5.0	V
Operating junction and storage temperature range	T _J , T _{STG}	-55 to +150	°C

NTOES:

- (1) Non-repetitive current pulse per fig.5 and derated above TA=25°C per fig.1
- (2) Measured on 8.3ms single half sine-wave or equivalent square wave, duty cycle=4 pulses per minute maximum
- (3) V_F<3.5V for devices of V_{BR}<200V and V_F<5.0V for devices of V_{BR}>201V

Company reserves the right to improve product design , functions and reliability without notice.

REV:D

Rating and Characteristic Curves (P6KE-HF Series)

Fig.1 - Pulse Derating Curve

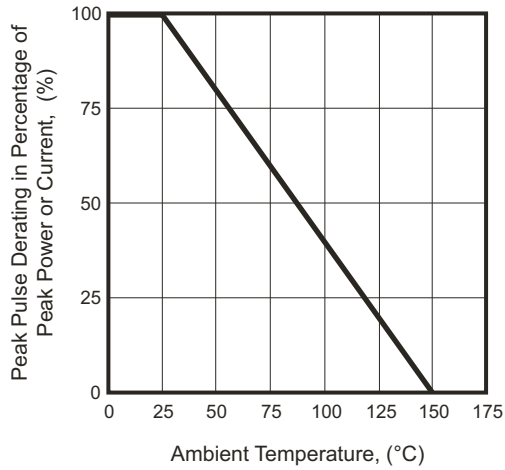

Fig.2 - Maximum Non-Repetitive Surge Current

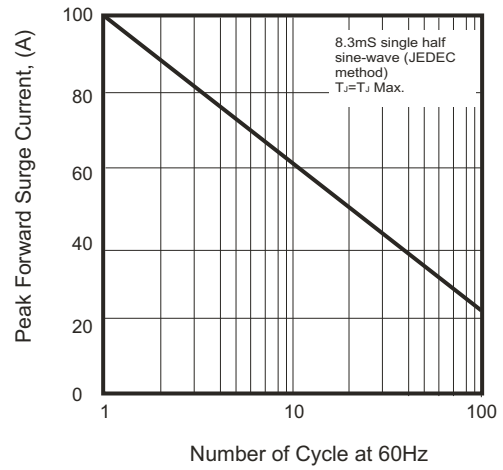

Fig.3 - Steady State Power Derating Curve

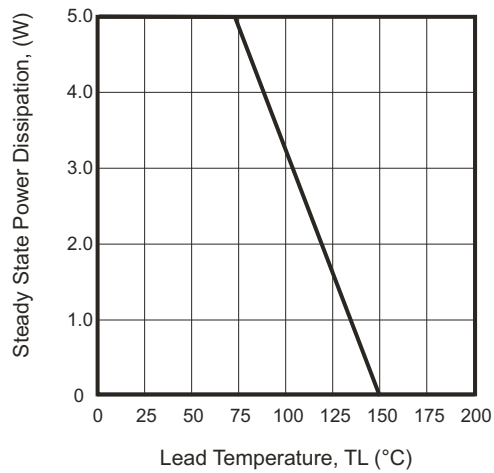

Fig.4 - Peak Pulse Power Rating Curve

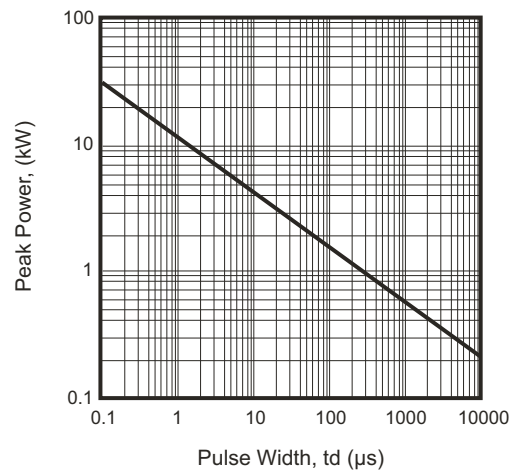

Fig.5 - Pulse Waveform

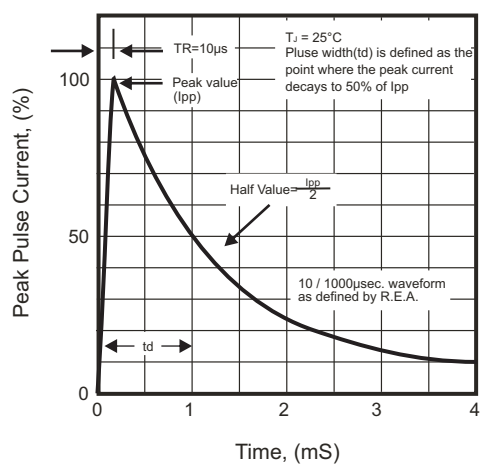
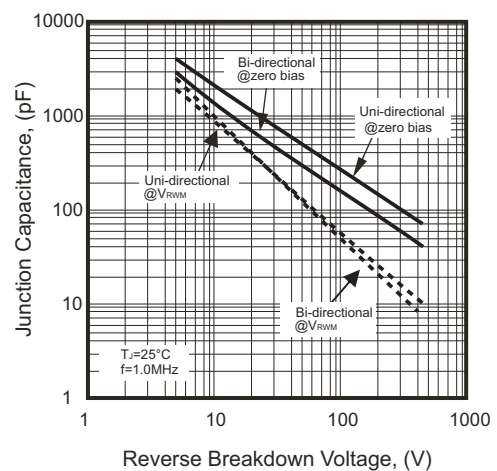

Fig.6 - Typical Junction Capacitance



Company reserves the right to improve product design, functions and reliability without notice.

600W Transient Voltage Suppressor

Electrical Characteristics (P6KE-HF Series)

Part No.	Breakdown voltage VBR @ IT			Maximum Reverse Leakage @VRWM IR (uA)	Working Peak Reverse Voltage VRWM (V)	Maximum Reverse Surge Current IPP (A)	Maximum Clamping Voltage @IPP Vc (V)	Marking Code	
	Min. (V)	Max. (V)	IT (mA)					UNI	BI
P6KE6.8(C)A-HF	6.46	7.14	10	1000	5.8	57.14	10.5	P6KE6.8A	P6KE6.8CA
P6KE7.5(C)A-HF	7.13	7.88	10	500	6.4	53.10	11.3	P6KE7.5A	P6KE7.5CA
P6KE8.2(C)A-HF	7.79	8.61	10	200	7.0	49.59	12.1	P6KE8.2A	P6KE8.2CA
P6KE9.1(C)A-HF	8.65	9.56	1	50	7.8	44.78	13.4	P6KE9.1A	P6KE9.1CA
P6KE10(C)A-HF	9.50	10.50	1	10	8.6	41.38	14.5	P6KE10A	P6KE10CA
P6KE11(C)A-HF	10.45	11.55	1	5.0	9.4	38.46	15.6	P6KE11A	P6KE11CA
P6KE12(C)A-HF	11.40	12.60	1	5.0	10.2	35.93	16.7	P6KE12A	P6KE12CA
P6KE13(C)A-HF	12.35	13.65	1	1	11.1	32.97	18.2	P6KE13A	P6KE13CA
P6KE15(C)A-HF	14.25	15.75	1	1	12.8	28.30	21.2	P6KE15A	P6KE15CA
P6KE16(C)A-HF	15.20	16.80	1	1	13.6	26.67	22.5	P6KE16A	P6KE16CA
P6KE18(C)A-HF	17.10	18.90	1	1	15.3	23.81	25.2	P6KE18A	P6KE18CA
P6KE20(C)A-HF	19.00	21.00	1	1	17.1	21.66	27.7	P6KE20A	P6KE20CA
P6KE22(C)A-HF	20.90	23.10	1	1	18.8	19.61	30.6	P6KE22A	P6KE22CA
P6KE24(C)A-HF	22.80	25.20	1	1	20.5	18.07	33.2	P6KE24A	P6KE24CA
P6KE27(C)A-HF	25.65	28.35	1	1	23.1	16.00	37.5	P6KE27A	P6KE27CA
P6KE30(C)A-HF	28.50	31.50	1	1	25.6	14.49	41.4	P6KE30A	P6KE30CA
P6KE33(C)A-HF	31.35	34.65	1	1	28.2	13.13	45.7	P6KE33A	P6KE33CA
P6KE36(C)A-HF	34.20	37.80	1	1	30.8	12.02	49.9	P6KE36A	P6KE36CA
P6KE39(C)A-HF	37.05	40.95	1	1	33.3	11.13	53.9	P6KE39A	P6KE39CA
P6KE43(C)A-HF	40.85	45.15	1	1	36.8	10.12	59.3	P6KE43A	P6KE43CA
P6KE47(C)A-HF	44.65	49.35	1	1	40.2	9.26	64.8	P6KE47A	P6KE47CA
P6KE51(C)A-HF	48.45	53.55	1	1	43.6	8.56	70.1	P6KE51A	P6KE51CA
P6KE56(C)A-HF	53.20	58.80	1	1	47.8	7.79	77.0	P6KE56A	P6KE56CA
P6KE62(C)A-HF	58.90	65.10	1	1	53.0	7.06	85.0	P6KE62A	P6KE62CA
P6KE68(C)A-HF	64.60	71.40	1	1	58.1	6.52	92.0	P6KE68A	P6KE68CA
P6KE75(C)A-HF	71.25	78.75	1	1	64.1	5.83	103.0	P6KE75A	P6KE75CA
P6KE82(C)A-HF	77.90	86.10	1	1	70.1	5.31	113.0	P6KE82A	P6KE82CA
P6KE91(C)A-HF	86.45	95.55	1	1	77.8	4.80	125.0	P6KE91A	P6KE91CA
P6KE100(C)A-HF	95.00	105.00	1	1	85.5	4.38	137.0	P6KE100A	P6KE100CA
P6KE110(C)A-HF	104.50	115.50	1	1	94.0	3.95	152.0	P6KE110A	P6KE110CA
P6KE120(C)A-HF	114.00	126.00	1	1	102.0	3.64	165.0	P6KE120A	P6KE120CA
P6KE130(C)A-HF	123.50	136.50	1	1	111.0	3.35	179.0	P6KE130A	P6KE130CA
P6KE150(C)A-HF	142.50	157.50	1	1	128.0	2.90	207.0	P6KE150A	P6KE150CA
P6KE160(C)A-HF	152.00	168.00	1	1	136.0	2.74	219.0	P6KE160A	P6KE160CA
P6KE170(C)A-HF	161.50	178.50	1	1	145.0	2.56	234.0	P6KE170A	P6KE170CA
P6KE180(C)A-HF	171.00	189.00	1	1	154.0	2.44	246.0	P6KE180A	P6KE180CA
P6KE200(C)A-HF	190.00	210.00	1	1	171.0	2.19	274.0	P6KE200A	P6KE200CA
P6KE220(C)A-HF	209.00	231.00	1	1	185.0	1.83	328.0	P6KE220A	P6KE220CA
P6KE250(C)A-HF	237.50	262.50	1	1	214.0	1.74	344.0	P6KE250A	P6KE250CA
P6KE300(C)A-HF	285.00	315.00	1	1	256.0	1.45	414.0	P6KE300A	P6KE300CA
P6KE350(C)A-HF	332.50	367.50	1	1	299.3	1.24	482.0	P6KE350A	P6KE350CA
P6KE380(C)A-HF	361.00	399.00	1	1	324.9	1.14	524.4	P6KE380A	P6KE380CA
P6KE400(C)A-HF	380.00	420.00	1	1	342.0	1.09	548.0	P6KE400A	P6KE400CA
P6KE440(C)A-HF	418.00	462.00	1	1	376.2	0.99	607.2	P6KE440A	P6KE440CA
P6KE500(C)A-HF	475.00	525.00	1	1	427.5	0.87	690.0	P6KE500A	P6KE500CA
P6KE520(C)A-HF	494.00	546.00	1	1	444.6	0.84	717.6	P6KE520A	P6KE520CA
P6KE550(C)A-HF	522.50	577.50	1	1	470.3	0.79	759.0	P6KE550A	P6KE550CA
P6KE600(C)A-HF	570.00	630.00	1	1	513.0	0.72	828.0	P6KE600A	P6KE600CA

- Note: 1) Suffix A denotes 5% tolerance devices.
 2) Add suffix "C" or "CA" after part number to specify Bi-directional devices.
 3) For Bi-Directional devices having VR of 10 volts and under, the IR limit is double.

Company reserves the right to improve product design , functions and reliability without notice.

REV:D

Taping Specification For Axial Lead Diodes

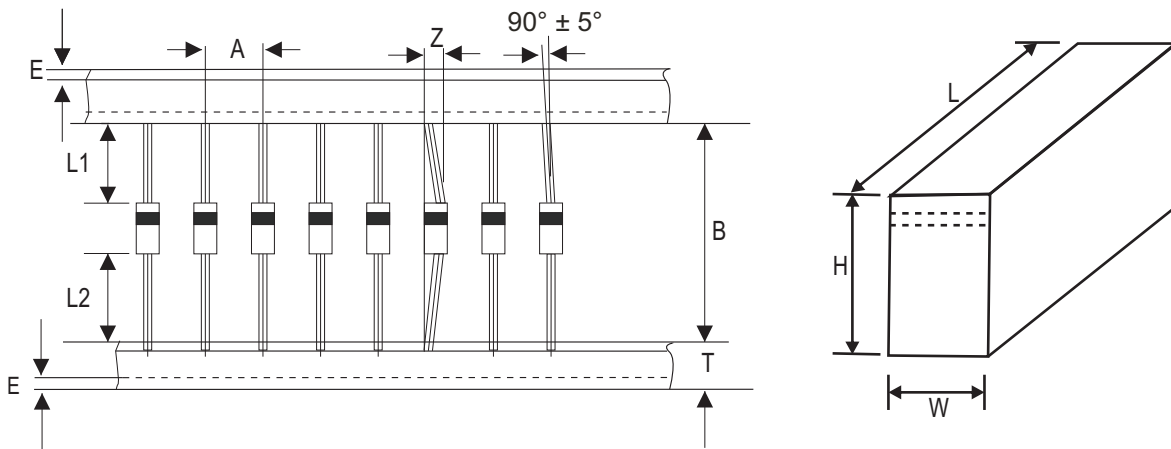

DO-15	SYMBOL	A	B	Z	T	E
	(mm)	5.00 ± 0.50	52.00 ± 0.50	1.20 (max)	6.00 ± 0.40	3.00 (max)
	(inch)	0.197 ± 0.020	2.047 ± 0.020	0.047 (max)	0.236 ± 0.016	0.118 (max)

DO-15	SYMBOL	L1	L2	L	W	H
	(mm)	1.00 (max)	1.00 (max)	260.00	75.00	145.00
	(inch)	0.039 (max)	0.039 (max)	10.236	2.953	5.709

Standard Packaging

Case Type	AMMO PACK	
	BOX (pcs)	CARTON (pcs)
DO-15	3,000	30,000

Looking for pricing, stock, or lifecycle information?

Click below to explore more details on WIN SOURCE:

- [View P6KE520CA-HF on WIN SOURCE](#)
- [Comchip Technology Information](#)

Optimize Your Supply Chain with WIN SOURCE Solutions

- ✓ Global Sourcing Solution
- ✓ Obsolete Management
- ✓ Cost Control Management
- ✓ Shortage Management
- ✓ Alternative Solution
- ✓ Excess Inventory Management