



**THE DATASHEET OF
PVU414S-TPBF**



Microelectronic Power IC

HEXFET® Power MOSFET Photovoltaic Relay
 Single Pole, Normally Open, 0-400V, 140mA AC /DC

General Description

The PVU414 Series Photovoltaic Relay is a single-pole, normally open solid-state relay that can replace electromechanical relays in many applications. It utilizes International Rectifier's proprietary HEXFET® power MOSFET as the output switch, driven by an integrated circuit photovoltaic generator of novel construction. The output switch is controlled by radiation from a GaAlAs light emitting diode (LED) which is optically isolated from the photovoltaic generator.

The PVU414 is ideally suited for instrumentation, multiplexing, scanning and data acquisition applications. It offers high operating speed, low thermal offset (EMF) voltage, low and stable on-state resistance and high off-state resistance.

The PVU414 relay is packaged in a 6-pin, molded DIP package with either thru-hole or surface-mount (gull-wing) terminals. It is available in standard plastic shipping tubes or on tape-and-reel. Please refer to Part Identification information.

Features

- HEXFET Power MOSFET output
- Bounce-free operation
- High operating speed
- High off-state resistance
- 0.2 μV thermal offset voltage
- 4,000 V_{RMS} I/O isolation
- Linear AC/DC operation
- Solid-State Reliability
- UL recognized
- ESD Tolerance:
 - 4000V Human Body Model
 - 500V Machine Model

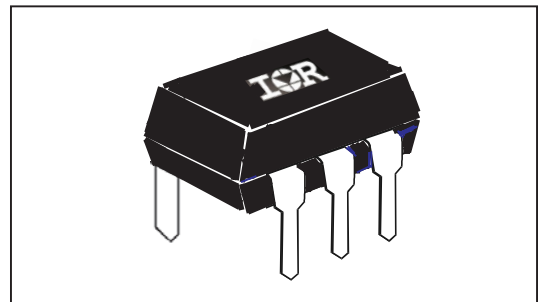

Applications

- Multiplexing
- Scanning
- Multichannel Sampling
- Data Acquisition
- Signal Level Switching
- Instrumentation and Measurement

Part Identification

PVU414PbF	thru-hole
PVU414SPbF	surface-mount
PVU414S-TPbF	surface-mount, tape and reel

(HEXFET is the registered trademark for International Rectifier's power MOSFETs)

Electrical Specifications ($-40^{\circ}\text{C} \leq T_A \leq +85^{\circ}\text{C}$ unless otherwise specified)

INPUT CHARACTERISTICS	Limits	Units
Minimum Control Current (see figure 1)	3.0	mA
Maximum Control Current for Off-State Resistance @ $T_A=+25^{\circ}\text{C}$	0.4	mA
Control Current Range (Caution: current limit input LED, see figure 6)	3.0 to 25	mA
Maximum Reverse Voltage	6.0	V

OUTPUT CHARACTERISTICS	Limits	Units
Operating Voltage Range	0 to ± 400	V(DC or AC peak)
Maximum Load Current @ $T_A=+40^{\circ}\text{C}$, 5mA Control (See figure 1)		
A Connection	140	mA (AC or DC)
B Connection	150	mA (DC)
C Connection	210	mA (DC)
Maximum On-State Resistance @ $T_A=+25^{\circ}\text{C}$ For 50mA pulsed load, 5mA Control (see figure 4)		
A Connection	27	Ω
B Connection	14	Ω
C Connection	7	Ω
Minimum Off-State Resistance @ $T_A=+25^{\circ}\text{C}$, $\pm 320\text{V}$ (see figure 5)	10^{10}	Ω
Maximum Turn-On Time @ $T_A=+25^{\circ}\text{C}$ (see figure 7) For 50mA, 100 V_{DC} Load, 5mA Control	500	μs
Maximum Turn-Off Time @ $T_A=+25^{\circ}\text{C}$ (see figure 7) For 50mA, 100 V_{DC} Load, 5mA Control	200	μs
Maximum Thermal Offset Voltage @ 5mA Control	0.2	μV
Maximum Output Capacitance @ 50V $_{DC}$ (see figure 2)	12	pF

GENERAL CHARACTERISTICS	Limits	Units
Minimum Dielectric Strength, Input-Output	4000	V_{RMS}
Minimum Insulation Resistance, Input-Output @ $T_A=+25^{\circ}\text{C}$, 50%RH, 100V $_{DC}$	10^{12}	Ω
Maximum Capacitance, Input-Output	1.0	pF
Maximum Pin Soldering Temperature (10 seconds maximum)	+260	$^{\circ}\text{C}$
Ambient Temperature Range:		$^{\circ}\text{C}$
Operating	-40 to +85	
Storage	-40 to +100	

International Rectifier does not recommend the use of this product in aerospace, avionics, military or life support applications. Users of this International Rectifier product in such applications assume all risks of such use and indemnify International Rectifier against all damages resulting from such use.

Connection Diagrams

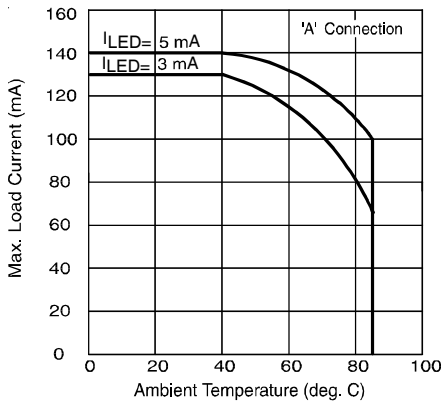
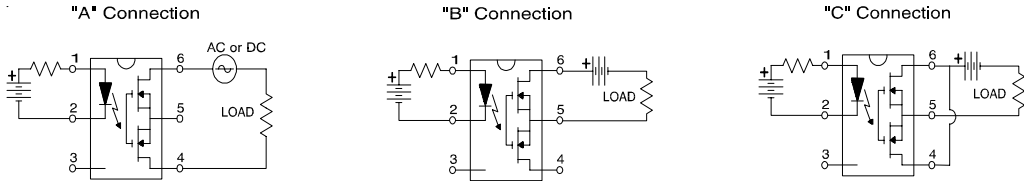

Figure 1. Current Derating Curves

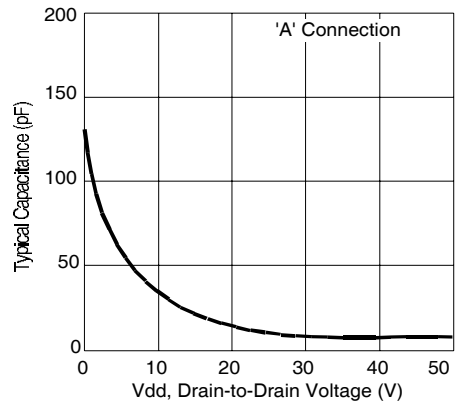

Figure 2. Typical Output Capacitance

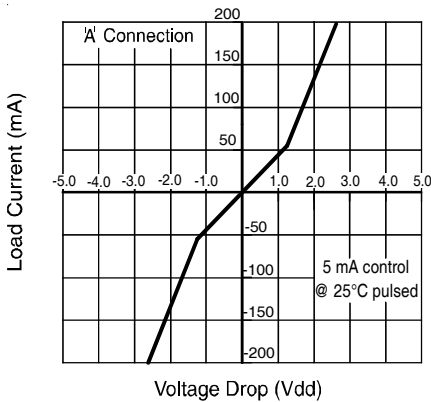

Figure 3. Linearity Characteristics

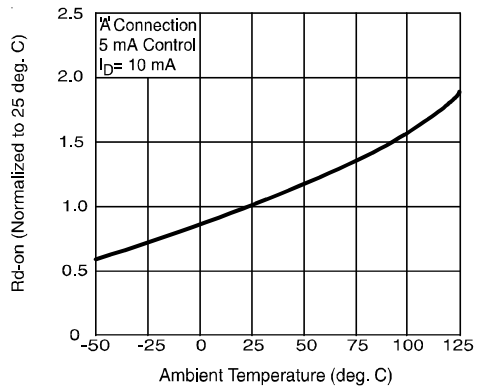

Figure 4. Typical Normalized On-Resistance

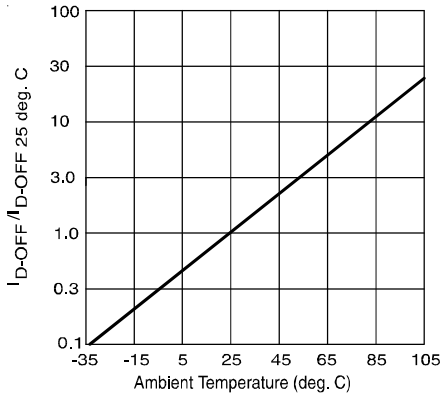

Figure 5. Typical Normalized Off-State Leakage

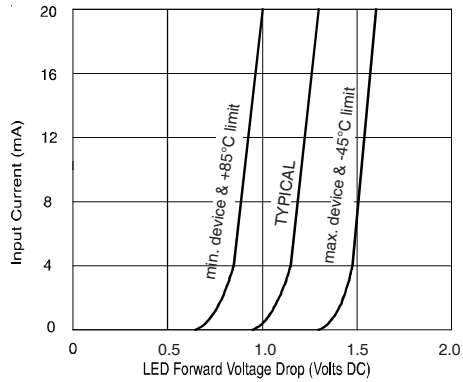

Figure 6. Input Characteristics (Current Controlled)

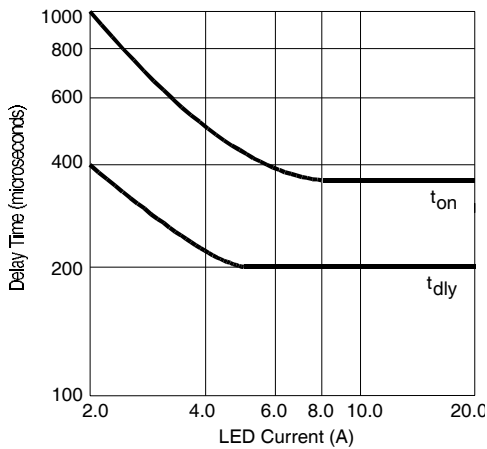

Figure 7. Typical Delay Times

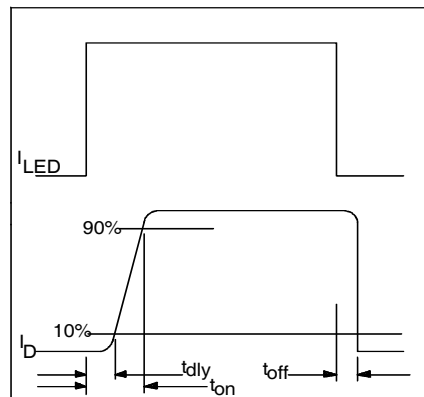
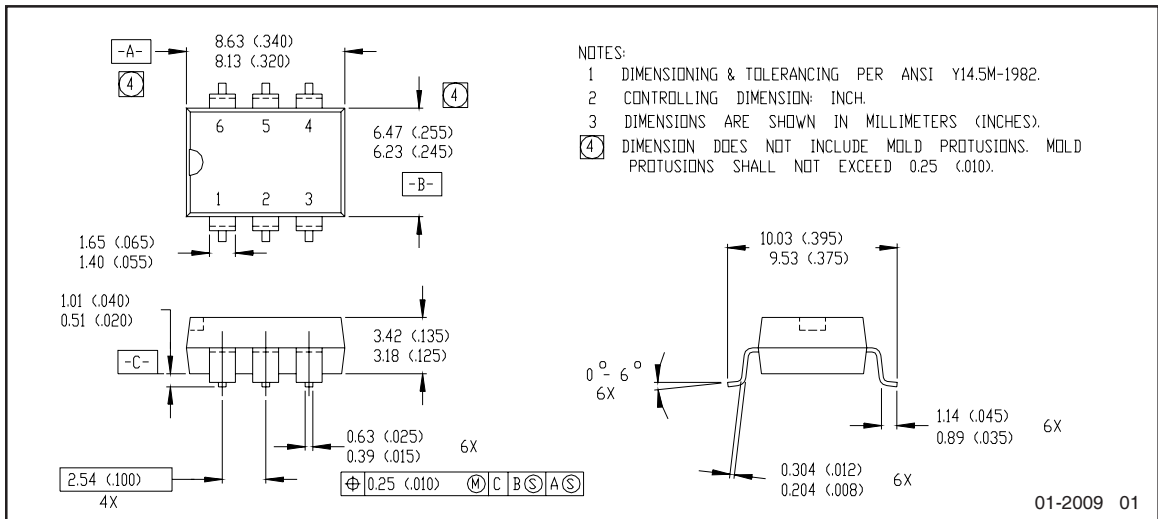
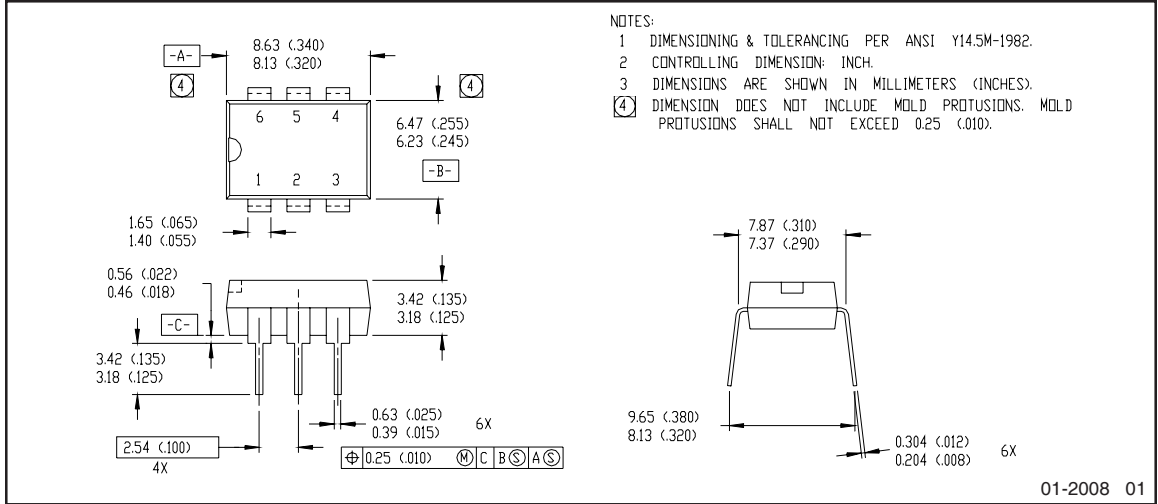

Figure 8. Delay Time Definitions

Case Outlines



Note: For the most current drawing please refer to IR website at: <http://www.irf.com/package/>

Qualification information[†]

Qualification level	Industrial (per JEDEC JESD471 ^{††} guidelines)	
Moisture Sensitivity Level	PVU414PbF	N/A
	PVU414SPbF	MSL4
	PVU414S-TPbF	(per JEDEC J-STD-020E & JEDEC J-STD-033C ^{††})
RoHS compliant	Yes	

† Qualification standards can be found at International Rectifier’s web site: <http://www.irf.com/product-info/reliability>

†† Applicable version of JEDEC standard at the time of product release

Revision History

Date	Comments
6/2/2015	<ul style="list-style-type: none"> • Added Qualification Information Table on page 6 • Updated data sheet with new IR corporate template

Looking for pricing, stock, or lifecycle information?

Click below to explore more details on WIN SOURCE:

-  [View PVU414S-TPBF on WIN SOURCE](#)
-  [Infineon Technologies](#) Information

Optimize Your Supply Chain with WIN SOURCE Solutions

-  Global Sourcing Solution
-  Obsolete Management
-  Cost Control Management
-  Shortage Management
-  Alternative Solution
-  Excess Inventory Management