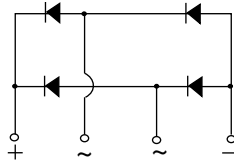
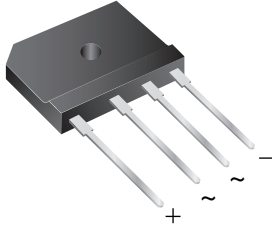




**THE DATASHEET OF
GSIB660-E3/45**



Single-Phase Single In-Line Bridge Rectifiers



Case Style GSIB-5S

FEATURES

- UL recognition file number E54214
- Thin single in-line package
- Glass passivated chip junction
- High surge current capability
- High case dielectric strength of 1500 V_{RMS}
- Solder dip 275 °C max. 10 s, per JESD 22-B106
- Material categorization: for definitions of compliance please see www.vishay.com/doc?99912


RoHS
COMPLIANT

TYPICAL APPLICATIONS

General purpose use in AC/DC bridge full wave rectification for switching power supply, home appliances, office equipment, industrial automation applications.

MECHANICAL DATA

Case: GSIB-5S

Molding compound meets UL 94 V-0 flammability rating
Base P/N-E3 - RoHS-compliant, commercial grade

Terminals: Matte tin plated leads, solderable per J-STD-002 and JESD 22-B102

E3 suffix meets JESD 201 class 1A whisker test

Polarity: As marked on body

Mounting Torque: 10 cm-kg (8.8 inches-lbs) max.

Recommended Torque: 5.7 cm-kg (5 inches-lbs)

PRIMARY CHARACTERISTICS	
Package	GSIB-5S
I _{F(AV)}	6.0 A
V _{RRM}	200 V, 400 V, 600 V, 800 V
I _{FSM}	180 A
I _R	10 μA
V _F at I _F = 3.0 V	0.95 V
T _J max.	150 °C
Diode variations	In-Line

MAXIMUM RATINGS (T _A = 25 °C unless otherwise specified)						
PARAMETER	SYMBOL	GSIB620	GSIB640	GSIB660	GSIB680	UNIT
Maximum repetitive peak reverse voltage	V _{RRM}	200	400	600	800	V
Maximum RMS voltage	V _{RMS}	140	280	420	560	V
Maximum DC blocking voltage	V _{DC}	200	400	600	800	V
Maximum average forward rectified output current at	I _{F(AV)}	6.0				A
		2.8				
Peak forward surge current single sine-wave superimposed on rated load (JEDEC method)	I _{FSM}	180				A
Rating for fusing (t < 8.3 ms)	I ² t	120				A ² s
Operating junction and storage temperature range	T _J , T _{STG}	-55 to +150				°C

Notes

(1) Unit case mounted on aluminum plate heatsink

(2) Units mounted on PCB with 0.5" x 0.5" (12 mm x 12 mm) copper pads and 0.375" (9.5 mm) lead length

ELECTRICAL CHARACTERISTICS (T _A = 25 °C unless otherwise noted)							
PARAMETER	TEST CONDITIONS	SYMBOL	GSIB620	GSIB640	GSIB660	GSIB680	UNIT
Maximum instantaneous forward voltage drop per diode	3.0 A	V _F	0.95				V
Maximum DC reverse current at rated DC blocking voltage per diode	T _A = 25 °C	I _R	10				μA
	T _A = 125 °C		250				

THERMAL CHARACTERISTICS ($T_A = 25\text{ }^\circ\text{C}$ unless otherwise noted)						
PARAMETER	SYMBOL	GSIB620	GSIB640	GSIB660	GSIB680	UNIT
Typical thermal resistance	$R_{\theta JA}$ (2)	22				
	$R_{\theta JC}$ (1)	3.4				

Notes

- (1) Unit case mounted on aluminum plate heatsink
- (2) Units mounted on PCB with 0.5" x 0.5" (12 mm x 12 mm) copper pads and 0.375" (9.5 mm) lead length
- (3) Recommended mounting position is to bolt down on heatsink with silicone thermal compound for maximum heat transfer with #6 screw

ORDERING INFORMATION (Example)				
PREFERRED P/N	UNIT WEIGHT (g)	PREFERRED PACKAGE CODE	BASE QUANTITY	DELIVERY MODE
GSIB660-E3/45	7.0	45	20	Tube

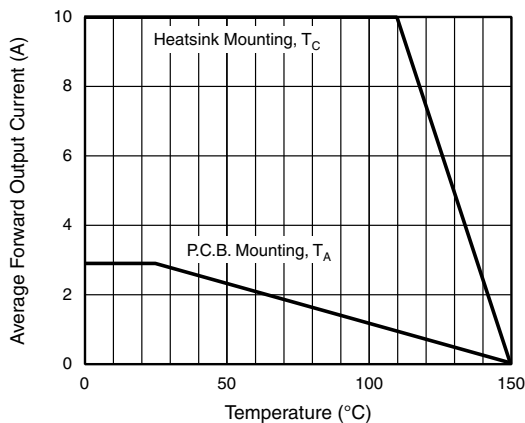
RATINGS AND CHARACTERISTICS CURVES ($T_A = 25\text{ }^\circ\text{C}$ unless otherwise noted)


Fig. 1 - Derating Curve Output Rectified Current

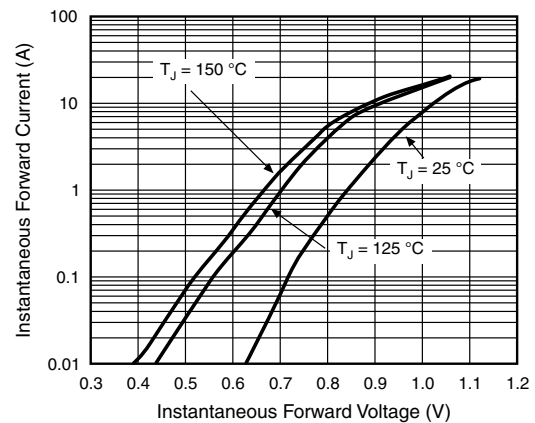


Fig. 3 - Typical Forward Characteristics Per Diode

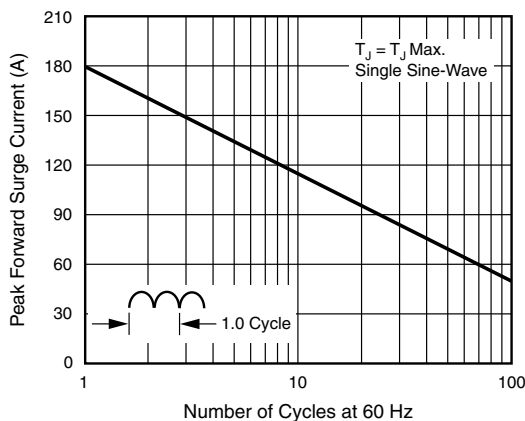


Fig. 2 - Maximum Non-Repetitive Peak Forward Surge Current Per Diode

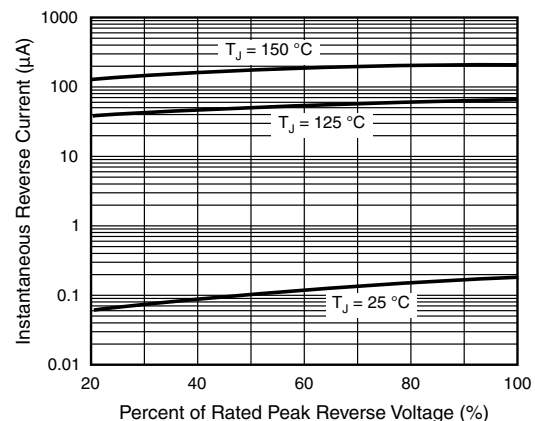


Fig. 4 - Typical Reverse Characteristics Per Diode

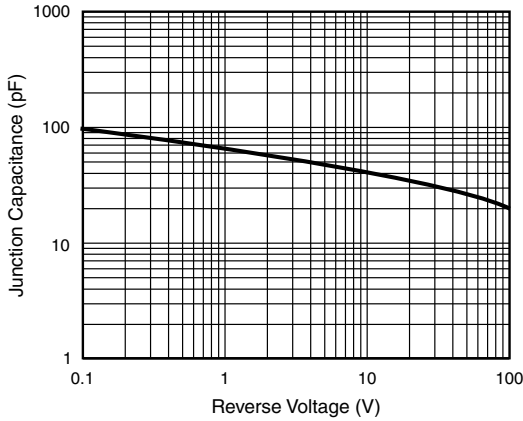


Fig. 5 - Typical Junction Capacitance Per Diode

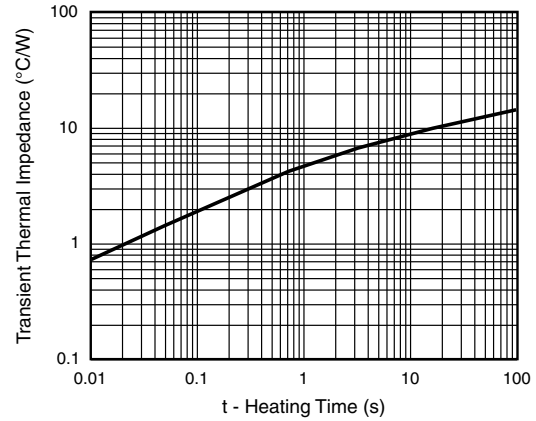
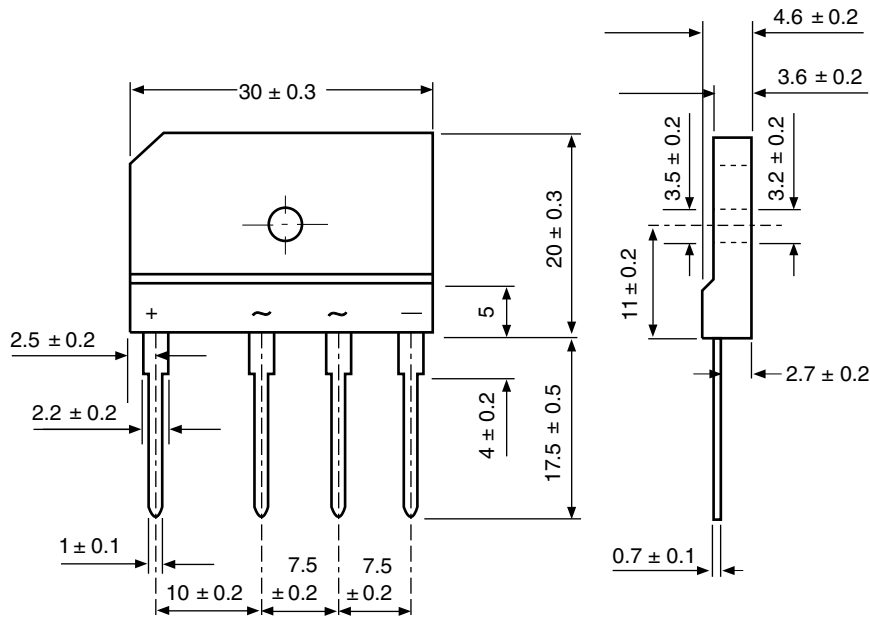


Fig. 6 - Typical Transient Thermal Impedance

PACKAGE OUTLINE DIMENSIONS in inches (millimeters)

Case Style GSIB-5S





Disclaimer

ALL PRODUCT, PRODUCT SPECIFICATIONS AND DATA ARE SUBJECT TO CHANGE WITHOUT NOTICE TO IMPROVE RELIABILITY, FUNCTION OR DESIGN OR OTHERWISE.

Vishay Intertechnology, Inc., its affiliates, agents, and employees, and all persons acting on its or their behalf (collectively, "Vishay"), disclaim any and all liability for any errors, inaccuracies or incompleteness contained in any datasheet or in any other disclosure relating to any product.

Vishay makes no warranty, representation or guarantee regarding the suitability of the products for any particular purpose or the continuing production of any product. To the maximum extent permitted by applicable law, Vishay disclaims (i) any and all liability arising out of the application or use of any product, (ii) any and all liability, including without limitation special, consequential or incidental damages, and (iii) any and all implied warranties, including warranties of fitness for particular purpose, non-infringement and merchantability.

Statements regarding the suitability of products for certain types of applications are based on Vishay's knowledge of typical requirements that are often placed on Vishay products in generic applications. Such statements are not binding statements about the suitability of products for a particular application. It is the customer's responsibility to validate that a particular product with the properties described in the product specification is suitable for use in a particular application. Parameters provided in datasheets and / or specifications may vary in different applications and performance may vary over time. All operating parameters, including typical parameters, must be validated for each customer application by the customer's technical experts. Product specifications do not expand or otherwise modify Vishay's terms and conditions of purchase, including but not limited to the warranty expressed therein.

Except as expressly indicated in writing, Vishay products are not designed for use in medical, life-saving, or life-sustaining applications or for any other application in which the failure of the Vishay product could result in personal injury or death. Customers using or selling Vishay products not expressly indicated for use in such applications do so at their own risk. Please contact authorized Vishay personnel to obtain written terms and conditions regarding products designed for such applications.

No license, express or implied, by estoppel or otherwise, to any intellectual property rights is granted by this document or by any conduct of Vishay. Product names and markings noted herein may be trademarks of their respective owners.

Looking for pricing, stock, or lifecycle information?

Click below to explore more details on WIN SOURCE:

 [View GSIB660-E3/45 on WIN SOURCE](#)

 [Vishay Information](#)

Optimize Your Supply Chain with WIN SOURCE Solutions

-  Global Sourcing Solution
-  Obsolete Management
-  Cost Control Management
-  Shortage Management
-  Alternative Solution
-  Excess Inventory Management