



**THE DATASHEET OF  
CDSF4148-HF**



## CDSF4148-HF

RoHS Device  
Halogen Free

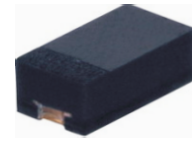

### Features

- High Speed.
- Designed for mounting on small surface.
- Extremely thin/leadless package.
- High mounting capability, strong surge withstand, high reliability.
- Use in sensitive electronics protection against voltage transients induced by inductive load switching and lighting on ICs, MOSFET, signal lines of sensor units for consumer, computer, industrial, automotive and telecommunication.

### Mechanical data

- Case: 1005/SOD-323F standard package, molded plastic.
- Terminals: Gold plated, solderable per MIL-STD-750, method 2026.
- Polarity: Indicated by cathode band.
- Mounting position: Any.
- Weight: 0.006 grams(approx.).

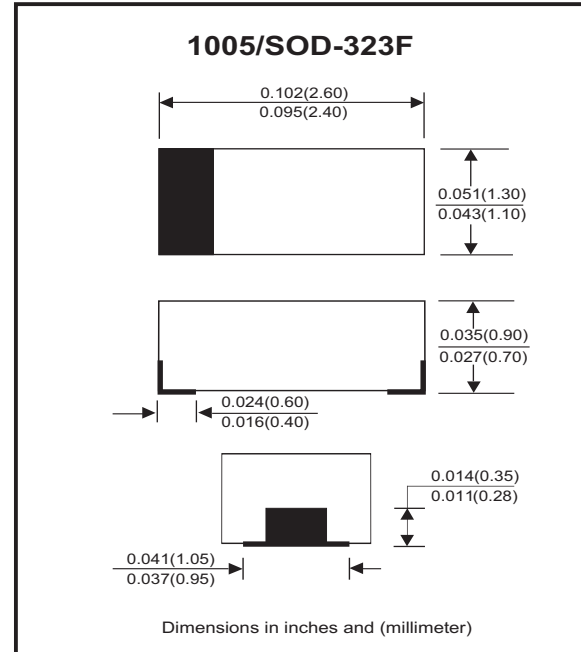

### Circuit diagram



### Maximum Rating (at TA=25 °C unless otherwise noted)

Parameter	Conditions	Symbol	Min	Typ	Max	Unit
Repetitive peak reverse voltage		V <sub>RRM</sub>			100	V
Reverse voltage		V <sub>R</sub>			75	V
Average forward current		I <sub>O</sub>			150	mA
Forward current, surge peak	T <sub>p</sub> =1μs T <sub>p</sub> =1ms	I <sub>FSM</sub>		4 1		A
Power dissipation		P <sub>D</sub>			350	mW
Thermal resistance junction to ambient air		R <sub>θJA</sub>			286	°C/W
Operating temperature range		T <sub>J</sub>	-40		+125	°C
Storage temperature range		T <sub>STG</sub>	-40		+125	°C

### Electrical Characteristics (at TA=25 °C unless otherwise noted)

Parameter	Conditions	Symbol	Min	Typ	Max	Unit
Reverse breakdown voltage	I <sub>R</sub> = 100 μA	V <sub>BR</sub>	75			V
Forward voltage	I <sub>F</sub> = 50 mA DC	V <sub>F</sub>			1.0	V
Reverse current	V <sub>R</sub> = 20V V <sub>R</sub> = 75V	I <sub>R</sub>			25 2.5	nA μA
Capacitance between terminals	f = 1MHz, and 0 VDC reverse voltage	C <sub>T</sub>			4	pF
Reverse recovery time	I <sub>F</sub> = I <sub>R</sub> = 10 mA, R <sub>L</sub> = 100 ohms, I <sub>rr</sub> = 1mA	T <sub>rr</sub>			4	nS

## RATING AND CHARACTERISTIC CURVES (CDSF4148-HF)

Fig.1 - Forward Characteristics

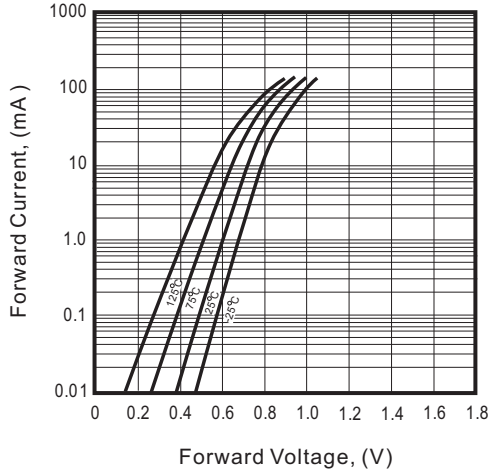

Fig.2 - Reverse Characteristics

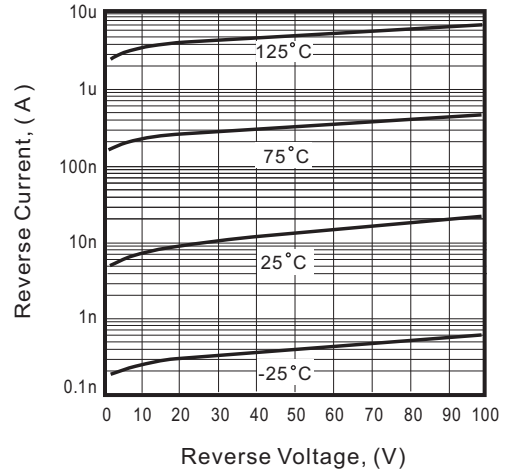

Fig.3 - Capacitance Between Terminals Characteristics

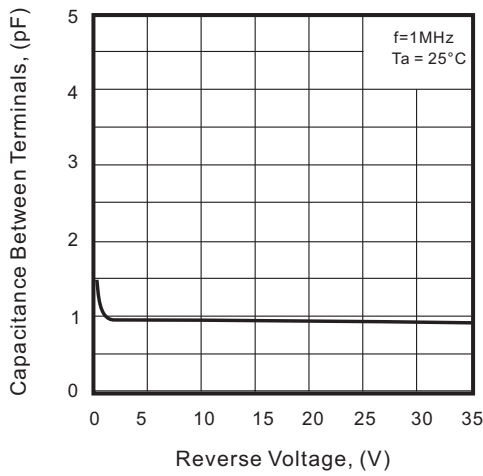
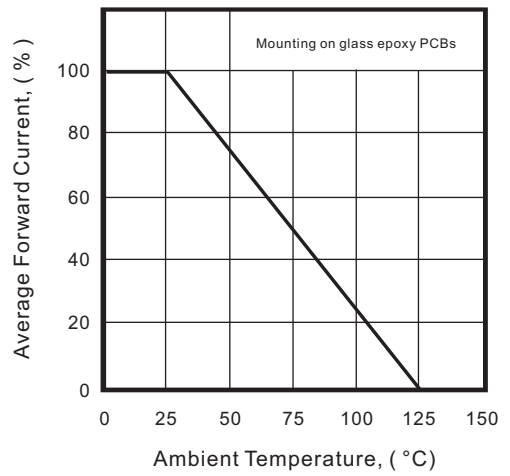
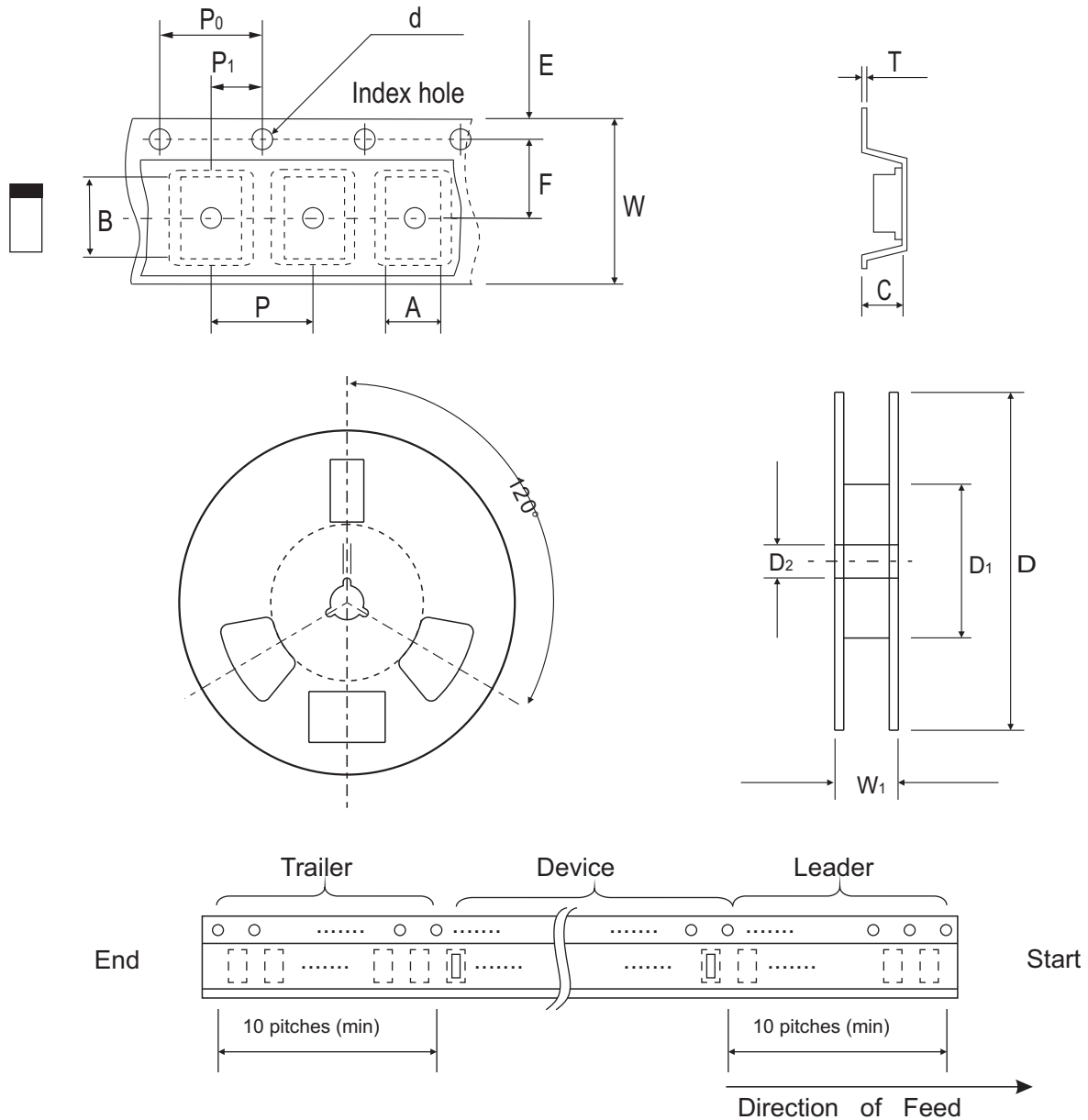

Fig.4 - Current Derating Curve



## Reel Taping Specification



1005 (SOD-323F)	SYMBOL	A	B	C	d	D	D <sub>1</sub>	D <sub>2</sub>
	(mm)	1.55 ± 0.10	2.65 ± 0.10	1.05 ± 0.10	1.55 ± 0.05	178 ± 1.0	60.0 MIN.	13.00 ± 0.20
	(inch)	0.061 ± 0.004	0.104 ± 0.004	0.041 ± 0.004	0.061 ± 0.002	7.008 ± 0.04	2.362 MIN.	0.512 ± 0.008

1005 (SOD-323F)	SYMBOL	E	F	P	P <sub>0</sub>	P <sub>1</sub>	T	W	W <sub>1</sub>
	(mm)	1.75 ± 0.10	3.50 ± 0.05	4.00 ± 0.10	4.00 ± 0.10	2.00 ± 0.05	0.23 ± 0.05	8.00 ± 0.20	13.5 MAX.
	(inch)	0.069 ± 0.004	0.138 ± 0.002	0.157 ± 0.004	0.157 ± 0.004	0.079 ± 0.002	0.009 ± 0.002	0.315 ± 0.008	0.531 MAX.

## Suggested PAD Layout

SIZE	1005/SOD-323F	
	(mm)	(inch)
A	2.10	0.083
B	1.20	0.047
C	1.20	0.047
D	3.30	0.130
E	0.90	0.035

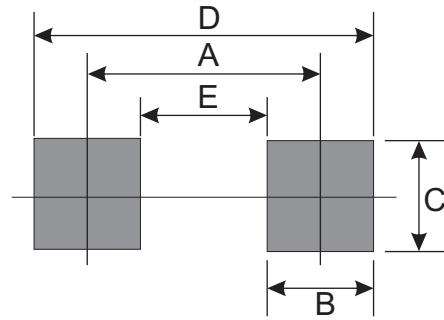



## Standard Packaging

Case Type	Qty Per Reel	Reel Size
	(Pcs)	(inch)
1005/SOD-323F	4,000	7

## Looking for pricing, stock, or lifecycle information?

Click below to explore more details on WIN SOURCE:

-  [View CDSF4148-HF on WIN SOURCE](#)
-  [Comchip Technology Information](#)

## Optimize Your Supply Chain with WIN SOURCE Solutions

-  Global Sourcing Solution
-  Obsolete Management
-  Cost Control Management
-  Shortage Management
-  Alternative Solution
-  Excess Inventory Management