



**THE DATASHEET OF
TMS320C40GFL40**



- **Highest Performance Floating-Point Digital Signal Processor (DSP)**
 - '320C40-60:
33-ns Instruction Cycle Time,
330 MOPS, 60 MFLOPS,
30 MIPS, 384M Bytes/s
 - '320C40-50:
40-ns Instruction Cycle Time
 - '320C40-40:
50-ns Instruction Cycle Time
- **Six Communications Ports**
- **Six-Channel Direct Memory Access (DMA) Coprocessor**
- **Single-Cycle Conversion to and From IEEE-754 Floating-Point Format**
- **Single Cycle, $1/x$, $1/\sqrt{x}$**
- **Source-Code Compatible With TMS320C3x**
- **Single-Cycle 40-Bit Floating-Point, 32-Bit Integer Multipliers**
- **Twelve 40-Bit Registers, Eight Auxiliary Registers, 14 Control Registers, and Two Timers**
- **IEEE 1149.1† (JTAG) Boundary Scan Compatible**
- **Two Identical External Data and Address Buses Supporting Shared Memory Systems and High Data-Rate, Single-Cycle Transfers:**
 - High Port-Data Rate of 120M Bytes/s ('C40-60) (Each Bus)
 - 16G-Byte Continuous Program/Data/Peripheral Address Space
 - Memory-Access Request for Fast, Intelligent Bus Arbitration
 - Separate Address-Bus, Data-Bus, and Control-Enable Pins
 - Four Sets of Memory-Control Signals Support Different Speed Memories in Hardware
- **325-Pin Ceramic Grid Array (GF Suffix)**
- **Fabricated Using 0.72- μ m Enhanced Performance Implanted CMOS (EPIC™) Technology by Texas Instruments (TI™)**
- **Software-Communication-Port Reset**
- **NMI With Bus-Grant Feature**

**325-PIN GF GRID ARRAY PACKAGE
(BOTTOM VIEW)‡**

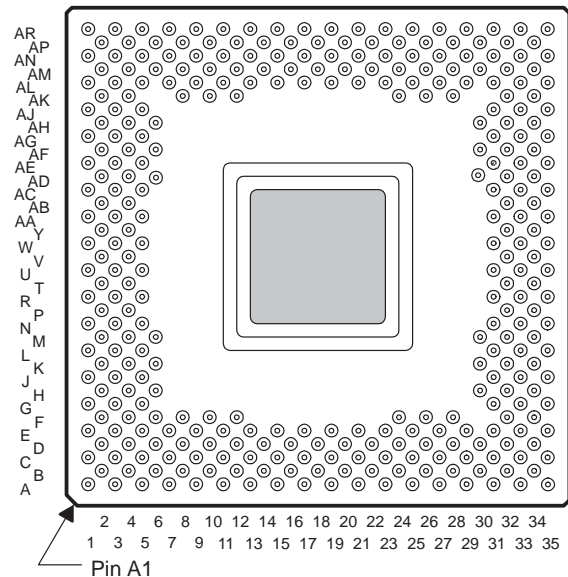

‡ See Pin Assignments table and Pin Functions table for location and description of all pins.

- **Separate Internal Program, Data, and DMA Coprocessor Buses for Support of Massive Concurrent Input/Output (I/O) of Program and Data Throughput, Maximizing Sustained Central Processing Unit (CPU) Performance**
- **On-Chip Program Cache and Dual-Access/Single-Cycle RAM for Increased Memory-Access Performance**
 - 512-Byte Instruction Cache
 - 8K Bytes of Single-Cycle Dual-Access Program or Data RAM
 - ROM-Based Boot Loader Supports Program Bootup Using 8-, 16-, or 32-Bit Memories or One of the Communication Ports
- **IDLE2 Clock-Stop Power-Down Mode**
- **5-V Operation**



Please be aware that an important notice concerning availability, standard warranty, and use in critical applications of Texas Instruments semiconductor products and disclaimers thereto appears at the end of this data sheet.

† IEEE Standard 1149.1–1990 Standard Test-Access Port and Boundary-Scan Architecture
EPIC and TI are trademarks of Texas Instruments Incorporated.

PRODUCTION DATA information is current as of publication date. Products conform to specifications per the terms of Texas Instruments standard warranty. Production processing does not necessarily include testing of all parameters.



block diagram (continued)

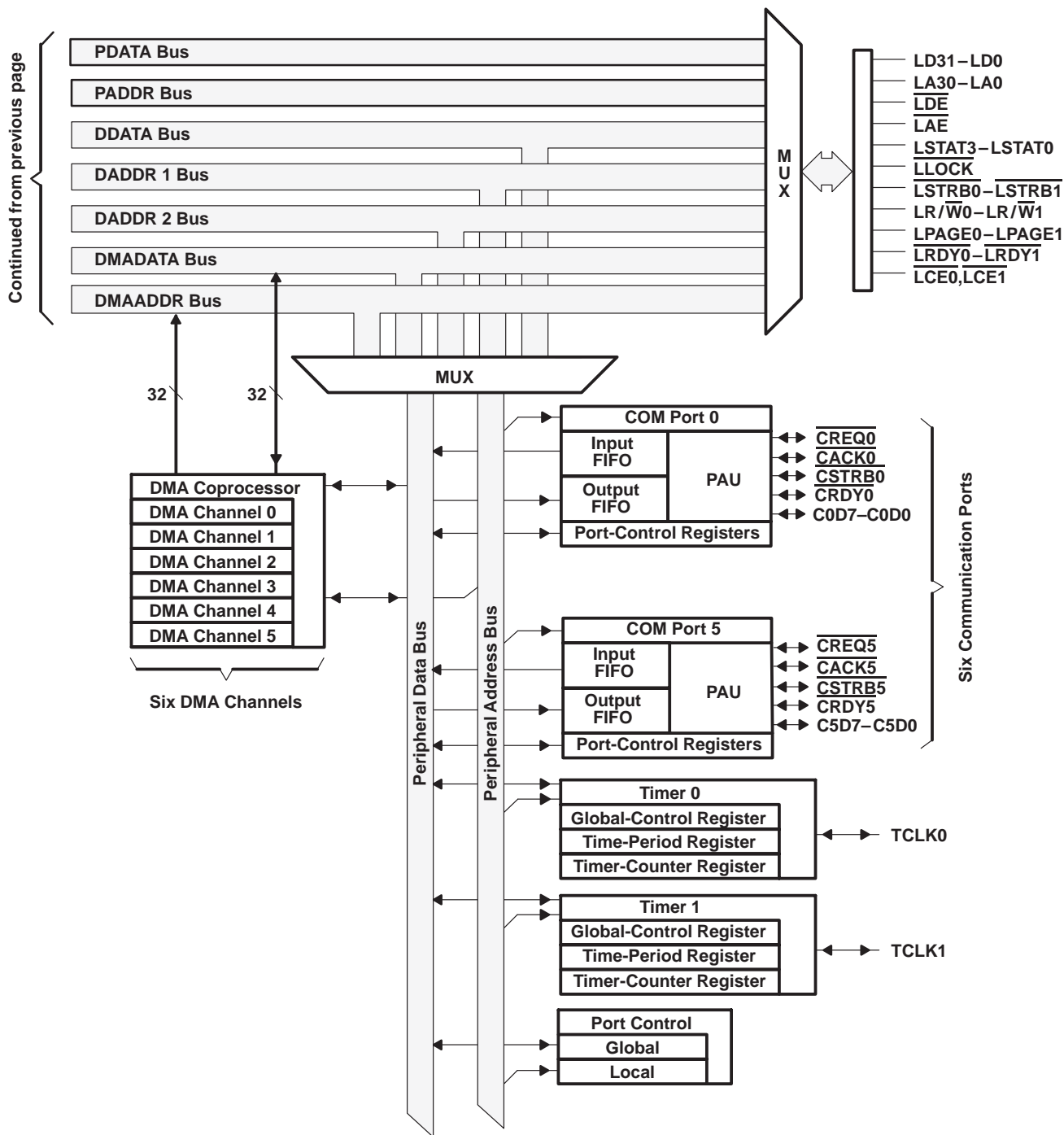

TMS320C40 DIGITAL SIGNAL PROCESSOR

SPRS038 – JANUARY 1996

functions

This section lists signal descriptions for the '320C40 device. The '320C40 pin functions table lists each signal, number of pins, operating mode(s) (that is, input, output, or high-impedance state as indicated by I, O, or Z, respectively), and function. The signals are grouped according to function.

Pin Functions

NAME	NO. OF PINS	TYPE†	DESCRIPTION
GLOBAL-BUS EXTERNAL INTERFACE (80 PINS)			
D31–D0	32	I/O/Z	32-bit data port of the global-bus external interface
\overline{DE}	1	I	Data-bus-enable signal for the global-bus external interface
A30–A0	31	O/Z	31-bit address port of the global-bus external interface
\overline{AE}	1	I	Address-bus-enable signal for the global-bus external interface
STAT3–STAT0	4	O	Status signals for the global-bus external interface
\overline{LOCK}	1	O	Lock signal for the global-bus external interface
$\overline{STRB0}‡$	1	O/Z	Access strobe 0 for the global-bus external interface
R/ $\overline{W0}‡$	1	O/Z	Read/write signal for $\overline{STRB0}$ accesses
PAGE0‡	1	O/Z	Page signal for $\overline{STRB0}$ accesses
$\overline{RDY0}‡$	1	I	Ready signal for $\overline{STRB0}$ accesses
$\overline{CE0}‡$	1	I	Control enable for the $\overline{STRB0}$, PAGE0, and R/ $\overline{W0}$ signals
$\overline{STRB1}‡$	1	O/Z	Access strobe 1 for the global-bus external interface
R/ $\overline{W1}‡$	1	O/Z	Read/write signal for $\overline{STRB1}$ accesses
PAGE1‡	1	O/Z	Page signal for $\overline{STRB1}$ accesses
$\overline{RDY1}‡$	1	I	Ready signal for $\overline{STRB1}$ accesses
$\overline{CE1}‡$	1	I	Control enable for the $\overline{STRB1}$, PAGE1, and R/ $\overline{W1}$ signals
LOCAL-BUS EXTERNAL INTERFACE (80 PINS)			
LD31–LD0	32	I/O/Z	32-bit data port of the local-bus external interface
\overline{LDE}	1	I	Data-bus-enable signal for the local-bus external interface
LA30–LA0	31	O/Z	31-bit address port of the local-bus external interface
\overline{LAE}	1	I	Address-bus-enable signal for the local-bus external interface
LSTAT3–LSTAT0	4	O	Status signals for the local-bus external interface
\overline{LLOCK}	1	O	Lock signal for the local-bus external interface
$\overline{LSTRB0}‡$	1	O/Z	Access strobe 0 for the local-bus external interface
LR/ $\overline{W0}$	1	O/Z	Read/write signal for $\overline{LSTRB0}$ accesses
LPAGE0	1	O/Z	Page signal for $\overline{LSTRB0}$ accesses
$\overline{LRDY0}$	1	I	Ready signal for $\overline{LSTRB0}$ accesses
$\overline{LCE0}$	1	I	Control enable for the $\overline{LSTRB0}$, LPAGE0, and LR/ $\overline{W0}$ signals
$\overline{LSTRB1}‡$	1	O/Z	Access strobe 1 for the local-bus external interface
LR/ $\overline{W1}$	1	O/Z	Read/write signal for $\overline{LSTRB1}$ accesses
LPAGE1	1	O/Z	Page signal for $\overline{LSTRB1}$ accesses
$\overline{LRDY1}$	1	I	Ready signal for $\overline{LSTRB1}$ accesses
$\overline{LCE1}$	1	I	Control enable for the $\overline{LSTRB1}$, LPAGE1, and LR/ $\overline{W1}$ signals

† I = input, O = output, Z = high impedance

‡ Signal's effective address range is defined by the local/global STRB ACTIVE bits.



Pin Functions (Continued)

NAME	NO. OF PINS	TYPE†	DESCRIPTION
COMMUNICATION PORT 0 INTERFACE (12 PINS)			
C0D7–C0D0	8	I/O	Communication port 0 data bus
$\overline{\text{CREQ0}}$	1	I/O	Communication port 0 token-request signal
$\overline{\text{CACK0}}$	1	I/O	Communication port 0 token-request-acknowledge signal
$\overline{\text{CSTRB0}}$	1	I/O	Communication port 0 data-strobe signal
$\overline{\text{CRDY0}}$	1	I/O	Communication port 0 data-ready signal
COMMUNICATION PORT 1 INTERFACE (12 PINS)			
C1D7–C1D0	8	I/O	Communication port 1 data bus
$\overline{\text{CREQ1}}$	1	I/O	Communication port 1 token-request signal
$\overline{\text{CACK1}}$	1	I/O	Communication port 1 token-request-acknowledge signal
$\overline{\text{CSTRB1}}$	1	I/O	Communication port 1 data-strobe signal
$\overline{\text{CRDY1}}$	1	I/O	Communication port 1 data-ready signal
COMMUNICATION PORT 2 INTERFACE (12 PINS)			
C2D7–C2D0	8	I/O	Communication port 2 data bus
$\overline{\text{CREQ2}}$	1	I/O	Communication port 2 token-request signal
$\overline{\text{CACK2}}$	1	I/O	Communication port 2 token-request-acknowledge signal
$\overline{\text{CSTRB2}}$	1	I/O	Communication port 2 data-strobe signal
$\overline{\text{CRDY2}}$	1	I/O	Communication port 2 data-ready signal
COMMUNICATION PORT 3 INTERFACE (12 PINS)			
C3D7–C3D0	8	I/O	Communication port 3 data bus
$\overline{\text{CREQ3}}$	1	I/O	Communication port 3 token-request signal
$\overline{\text{CACK3}}$	1	I/O	Communication port 3 token-request-acknowledge signal
$\overline{\text{CSTRB3}}$	1	I/O	Communication port 3 data-strobe signal
$\overline{\text{CRDY3}}$	1	I/O	Communication port 3 data-ready signal
COMMUNICATION PORT 4 INTERFACE (12 PINS)			
C4D7–C4D0	8	I/O	Communication port 4 data bus
$\overline{\text{CREQ4}}$	1	I/O	Communication port 4 token-request signal
$\overline{\text{CACK4}}$	1	I/O	Communication port 4 token-request-acknowledge signal
$\overline{\text{CSTRB4}}$	1	I/O	Communication port 4 data-strobe signal
$\overline{\text{CRDY4}}$	1	I/O	Communication port 4 data-ready signal
COMMUNICATION PORT 5 INTERFACE (12 PINS)			
C5D7–C5D0	8	I/O	Communication port 5 data bus
$\overline{\text{CREQ5}}$	1	I/O	Communication port 5 token-request signal
$\overline{\text{CACK5}}$	1	I/O	Communication port 5 token-request-acknowledge signal
$\overline{\text{CSTRB5}}$	1	I/O	Communication port 5 data-strobe signal
$\overline{\text{CRDY5}}$	1	I/O	Communication port 5 data-ready signal

† I = input, O = output, Z = high impedance

TMS320C40 DIGITAL SIGNAL PROCESSOR

SPRS038 – JANUARY 1996

Pin Functions (Continued)

NAME	NO. OF PINS	TYPE†	DESCRIPTION
INTERRUPTS, I/O FLAGS, RESET, TIMER (12 PINS)			
$\overline{\text{IIOF3}}\text{--}\overline{\text{IIOF0}}$	4	I/O	Interrupt and I/O flags
$\overline{\text{NMI}}$	1	I	Nonmaskable interrupt. $\overline{\text{NMI}}$ is sensitive to a low-going edge.
$\overline{\text{IACK}}$	1	O	Interrupt acknowledge
$\overline{\text{RESET}}$	1	I	Reset signal
$\overline{\text{RESETLOC1}}\text{--}\overline{\text{RESETLOC0}}$	2	I	Reset-vector location pins
ROMEN	1	I	On-chip ROM enable (0 = disable, 1 = enable)
TCLK0	1	I/O	Timer 0 pin
TCLK1	1	I/O	Timer 1 pin
CLOCK (4 PINS)			
X1	1	O	Crystal pin
X2/CLKIN	1	I	Crystal/oscillator pin
H1	1	O	H1 clock
H3	1	O	H3 clock
POWER (70 PINS)			
CVSS	15	I	Ground pins
DVSS	15	I	Ground pins
IVSS	6	I	Ground pins
DVDD	13	I	5- V_{DC} supply pins
GADVDD	3	I	5- V_{DC} supply pins
GDDVDD	3	I	5- V_{DC} supply pins
LADVDD	3	I	5- V_{DC} supply pins
LDDVDD	3	I	5- V_{DC} supply pins
SUBS	1	I	Substrate pin (tie to ground)
VDDL	4	I	5- V_{DC} supply pins
VSSL	4	I	Ground pins
EMULATION (7 PINS)			
TCK	1	I	IEEE 1149.1 test port clock
TDO	1	O/Z	IEEE 1149.1 test port data out
TDI	1	I	IEEE 1149.1 test port data in
TMS	1	I	IEEE 1149.1 test port mode select
$\overline{\text{TRST}}$	1	I	IEEE 1149.1 test port reset
EMU0	1	I/O	Emulation pin 0
EMU1	1	I/O	Emulation pin 1

† I = input, O = output, Z = high impedance



GF Package Pin Assignments — Alphabetical Listing

PIN		PIN		PIN		PIN		PIN	
NAME	NO.	NAME	NO.	NAME	NO.	NAME	NO.	NAME	NO.
A0	D32	C0D6	AN7	C5D4	AM30	CVSS	E35	D31	F32
A1	B32	C0D7	AK8	C5D5	AP32	CVSS	AR25	\overline{DE}	AA31
A2	D30	C1D0	AL7	C5D6	AM32	CVSS	AE1	DVDD	AR11
A3	C29	C1D1	AP8	C5D7	AL31	CVSS	AR13	DVDD	AR29
A4	B30	C1D2	AM8	$\overline{CACK0}$	AN11	CVSS	A19	DVDD	A13
A5	F28	C1D3	AK12	$\overline{CACK1}$	AN13	CVSS	R35	DVDD	A7
A6	F24	C1D4	AK10	$\overline{CACK2}$	AM14	CVSS	AL1	DVDD	A17
A7	E29	C1D5	AN9	$\overline{CACK3}$	AM16	D0	U33	DVDD	L35
A8	C27	C1D6	AL9	$\overline{CACK4}$	AK32	D1	V32	DVDD	AR23
A9	D28	C1D7	AP10	$\overline{CACK5}$	AJ31	D2	T34	DVDD	A29
A10	B28	C2D0	AM18	$\overline{CE0}$	AA33	D3	U31	DVDD	L1
A11	F26	C2D1	AN19	$\overline{CE1}$	V34	D4	R33	DVDD	AC1
A12	C25	C2D2	AL19	$\overline{CRDY0}$	AP12	D5	P34	DVDD	AR17
A13	E27	C2D3	AP20	$\overline{CRDY1}$	AP14	D6	T32	DVDD	A23
A14	B26	C2D4	AM20	$\overline{CRDY2}$	AL15	D7	N33	DVDD	AJ1
A15	D26	C2D5	AN21	$\overline{CRDY3}$	AL17	D8	R31	DVSS	AJ35
A16	C23	C2D6	AL21	$\overline{CRDY4}$	AH30	D9	M34	DVSS	A21
A17	B24	C2D7	AP22	$\overline{CRDY5}$	AH32	D10	P32	DVSS	A25
A18	E25	C3D0	AM22	$\overline{CREQ0}$	AM10	D11	L33	DVSS	G35
A19	C21	C3D1	AN23	$\overline{CREQ1}$	AM12	D12	N31	DVSS	A11
A20	D24	C3D2	AL23	$\overline{CREQ2}$	AN15	D13	K34	DVSS	AG1
A21	B22	C3D3	AP24	$\overline{CREQ3}$	AN17	D14	M32	DVSS	AM2
A22	E23	C3D4	AM24	$\overline{CREQ4}$	AN33	D15	J33	DVSS	R1
A23	C19	C3D5	AN25	$\overline{CREQ5}$	AL33	D16	L31	DVSS	AR21
A24	D22	C3D6	AL25	$\overline{CSTRB0}$	AL11	D17	M30	DVSS	AR15
A25	B20	C3D7	AP26	$\overline{CSTRB1}$	AL13	D18	K32	DVSS	A15
A26	E21	C4D0	AN27	$\overline{CSTRB2}$	AP16	D19	H34	DVSS	AR27
A27	B18	C4D1	AM26	$\overline{CSTRB3}$	AP18	D20	J31	DVSS	G1
A28	C17	C4D2	AK24	$\overline{CSTRB4}$	AM34	D21	G33	DVSS	N35
A29	D20	C4D3	AL27	$\overline{CSTRB5}$	AK34	D22	K30	DVSS	AR9
A30	B16	C4D4	AP28	CVSS	AR19	D23	F34	EMU0	AA35
\overline{AE}	AG31	C4D5	AK26	CVSS	AR7	D24	H32	EMU1	AD34
C0D0	AP4	C4D6	AN29	CVSS	N1	D25	E33	GADVDD	B2
C0D1	AL5	C4D7	AM28	CVSS	AL35	D26	D34	GADVDD	AR1
C0D2	AN5	C5D0	AL29	CVSS	A27	D27	G31	GADVDD	U35
C0D3	AM4	C5D1	AP30	CVSS	A9	D28	C33	GDDVDD	V2
C0D4	AP6	C5D2	AK28	CVSS	E1	D29	H30	GDDVDD	A35
C0D5	AM6	C5D3	AN31	CVSS	J35	D30	E31	GDDVDD	A1

TMS320C40 DIGITAL SIGNAL PROCESSOR

SPRS038 – JANUARY 1996

GF Package Pin Assignments — Alphabetical Listing (Continued)

PIN		PIN		PIN		PIN	
NAME	NO.	NAME	NO.	NAME	NO.	NAME	NO.
H1	AC3	LA25	R5	LD26	B4	STAT0	AD32
H3	AC5	LA26	T2	LD27	F8	STAT1	AE33
$\overline{\text{IACK}}$	W3	LA27	U3	LD28	D6	STAT2	AF34
$\overline{\text{IIOF0}}$	AN3	LA28	T4	LD29	C3	STAT3	AE31
$\overline{\text{IIOF1}}$	AL3	LA29	V4	LD30	E5	$\overline{\text{STRB0}}$	AD30
$\overline{\text{IIOF2}}$	AH6	LA30	U5	LD31	F6	$\overline{\text{STRB1}}$	AC33
$\overline{\text{IIOF3}}$	AK2	LADV _{DD}	B34	LDDV _{DD}	AR35	SUBS	C31
IV _{SS}	AR5	LADV _{DD}	AB2	LDDV _{DD}	AP2	TCK	Y34
IV _{SS}	AR31	LADV _{DD}	AP34	LDDV _{DD}	U1	TCLK0	AE3
IV _{SS}	AG35	$\overline{\text{LAE}}$	AB4	$\overline{\text{LDE}}$	AD4	TCLK1	AD2
IV _{SS}	A31	$\overline{\text{LCE0}}$	AG5	$\overline{\text{LLOCK}}$	AA5	TDO	AB34
IV _{SS}	J1	$\overline{\text{LCE1}}$	AF2	$\overline{\text{LOCK}}$	W33	TDI	AC35
IV _{SS}	A5	LD0	E19	LPAGE0	AH2	TMS	W35
LA0	D2	LD1	C15	LPAGE1	AG3	$\overline{\text{TRST}}$	AE35
LA1	D4	LD2	D18	$\overline{\text{LRDY0}}$	AF6	VDDL	AN1
LA2	E3	LD3	B14	$\overline{\text{LRDY1}}$	AE5	VDDL	AN35
LA3	F4	LD4	E17	LR/ $\overline{\text{W0}}$	AH4	VDDL	C35
LA4	H6	LD5	D16	LR/ $\overline{\text{W1}}$	AF4	VDDL	C1
LA5	F2	LD6	C13	LSTAT0	AA3	VSSL	A3
LA6	G5	LD7	E15	LSTAT1	Y4	VSSL	AR3
LA7	G3	LD8	B12	LSTAT2	Y2	VSSL	AR33
LA8	H4	LD9	D14	LSTAT3	W5	VSSL	A33
LA9	H2	LD10	C11	$\overline{\text{LSTRB0}}$	AJ3	X1	W1
LA10	K6	LD11	E13	$\overline{\text{LSTRB1}}$	AD6	X2/CLKIN	AA1
LA11	M6	LD12	B10	$\overline{\text{NMI}}$	AJ5		
LA12	J5	LD13	D12	PAGE0	AG33		
LA13	J3	LD14	C9	PAGE1	AB32		
LA14	K4	LD15	E11	$\overline{\text{RDY0}}$	Y32		
LA15	K2	LD16	F12	$\overline{\text{RDY1}}$	W31		
LA16	L3	LD17	D10	RESETLOC0	AF30		
LA17	L5	LD18	B8	RESETLOC1	AH34		
LA18	M2	LD19	E9	$\overline{\text{RESET}}$	AJ33		
LA19	M4	LD20	C7	ROMEN	AK4		
LA20	N3	LD21	F10	R/ $\overline{\text{W0}}$	AF32		
LA21	N5	LD22	B6	R/ $\overline{\text{W1}}$	AC31		
LA22	P2	LD23	D8				
LA23	P4	LD24	C5				
LA24	R3	LD25	E7				



GF Package Pin Assignments — Numerical Listing

PIN		PIN		PIN		PIN	
NO.	NAME	NO.	NAME	NO.	NAME	NO.	NAME
A1	GDDV _{DD}	AD30	STRB ₀	AK24	C4D2	AM30	C5D4
A3	V _{SSL}	AD32	STAT0	AK26	C4D5	AM32	C5D6
A5	IV _{SS}	AD34	EMU1	AK28	C5D2	AM34	CSTRB ₄
A7	DV _{DD}	AE1	CV _{SS}	AK32	CACK ₄	AN1	V _{DDL}
A9	CV _{SS}	AE3	TCLK0	AK34	CSTRB ₅	AN3	IIOF ₀
A11	DV _{SS}	AE5	LRDY ₁	AL1	CV _{SS}	AN5	C0D2
A13	DV _{DD}	AE31	STAT3	AL3	IIOF ₁	AN7	C0D6
A15	DV _{SS}	AE33	STAT1	AL5	C0D1	AN9	C1D5
A17	DV _{DD}	AE35	TRST	AL7	C1D0	AN11	CACK ₀
A19	CV _{SS}	AF2	LCE ₁	AL9	C1D6	AN13	CACK ₁
A21	DV _{SS}	AF4	LR/W ₁	AL11	CSTRB ₀	AN15	CREQ ₂
A23	DV _{DD}	AF6	LRDY ₀	AL13	CSTRB ₁	AN17	CREQ ₃
A25	DV _{SS}	AF30	RESETLOC0	AL15	CRDY ₂	AN19	C2D1
A27	CV _{SS}	AF32	R/W ₀	AL17	CRDY ₃	AN21	C2D5
A29	DV _{DD}	AF34	STAT2	AL19	C2D2	AN23	C3D1
A31	IV _{SS}	AG1	DV _{SS}	AL21	C2D6	AN25	C3D5
A33	V _{SSL}	AG3	LPAGE1	AL23	C3D2	AN27	C4D0
A35	GDDV _{DD}	AG5	LCE ₀	AL25	C3D6	AN29	C4D6
AA1	X2/CLKIN	AG31	AE	AL27	C4D3	AN31	C5D3
AA3	LSTAT0	AG33	PAGE0	AL29	C5D0	AN33	CREQ ₄
AA5	LLOCK	AG35	IV _{SS}	AL31	C5D7	AN35	V _{DDL}
AA31	DE	AH2	LPAGE0	AL33	CREQ ₅	AP2	LDDV _{DD}
AA33	CE ₀	AH4	LR/W ₀	AL35	CV _{SS}	AP4	C0D0
AA35	EMU0	AH6	IIOF ₂	AM2	DV _{SS}	AP6	C0D4
AB2	LADV _{DD}	AH30	CRDY ₄	AM4	C0D3	AP8	C1D1
AB4	LAE	AH32	CRDY ₅	AM6	C0D5	AP10	C1D7
AB32	PAGE1	AH34	RESETLOC1	AM8	C1D2	AP12	CRDY ₀
AB34	TDO	AJ1	DV _{DD}	AM10	CREQ ₀	AP14	CRDY ₁
AC1	DV _{DD}	AJ3	LSTRB ₀	AM12	CREQ ₁	AP16	CSTRB ₂
AC3	H1	AJ5	NMI	AM14	CACK ₂	AP18	CSTRB ₃
AC5	H3	AJ31	CACK ₅	AM16	CACK ₃	AP20	C2D3
AC31	R/W ₁	AJ33	RESET	AM18	C2D0	AP22	C2D7
AC33	STRB ₁	AJ35	DV _{SS}	AM20	C2D4	AP24	C3D3
AC35	TDI	AK2	IIOF ₃	AM22	C3D0	AP26	C3D7
AD2	TCLK1	AK4	ROMEN	AM24	C3D4	AP28	C4D4
AD4	LDE	AK8	C0D7	AM26	C4D1	AP30	C5D1
AD6	LSTRB ₁	AK10	C1D4	AM28	C4D7	AP32	C5D5
		AK12	C1D3			AP34	LADV _{DD}

TMS320C40 DIGITAL SIGNAL PROCESSOR

SPRS038 – JANUARY 1996

GF Package Pin Assignments — Numerical Listing (Continued)

PIN		PIN		PIN		PIN		PIN	
NO.	NAME	NO.	NAME	NO.	NAME	NO.	NAME	NO.	NAME
AR1	GADVDD	C1	VDDL	E1	CVSS	H2	LA9	P2	LA22
AR3	VSSL	C3	LD29	E3	LA2	H4	LA8	P4	LA23
AR5	IVSS	C5	LD24	E5	LD30	H6	LA4	P32	D10
AR7	CVSS	C7	LD20	E7	LD25	H30	D29	P34	D5
AR9	DVSS	C9	LD14	E9	LD19	H32	D24	R1	DVSS
AR11	DVDD	C11	LD10	E11	LD15	H34	D19	R3	LA24
AR13	CVSS	C13	LD6	E13	LD11	J1	IVSS	R5	LA25
AR15	DVSS	C15	LD1	E15	LD7	J3	LA13	R31	D8
AR17	DVDD	C17	A28	E17	LD4	J5	LA12	R33	D4
AR19	CVSS	C19	A23	E19	LD0	J31	D20	R35	CVSS
AR21	DVSS	C21	A19	E21	A26	J33	D15	T2	LA26
AR23	DVDD	C23	A16	E23	A22	J35	CVSS	T4	LA28
AR25	CVSS	C25	A12	E25	A18	K2	LA15	T32	D6
AR27	DVSS	C27	A8	E27	A13	K4	LA14	T34	D2
AR29	DVDD	C29	A3	E29	A7	K6	LA10	U1	LDDVDD
AR31	IVSS	C31	SUBS	E31	D30	K30	D22	U3	LA27
AR33	VSSL	C33	D28	E33	D25	K32	D18	U5	LA30
AR35	LDDVDD	C35	VDDL	E35	CVSS	K34	D13	U31	D3
B2	GADVDD	D2	LA0	F2	LA5	L1	DVDD	U33	D0
B4	LD26	D4	LA1	F4	LA3	L3	LA16	U35	GADVDD
B6	LD22	D6	LD28	F6	LD31	L5	LA17	V2	GDDVDD
B8	LD18	D8	LD23	F8	LD27	L31	D16	V4	LA29
B10	LD12	D10	LD17	F10	LD21	L33	D11	V32	D1
B12	LD8	D12	LD13	F12	LD16	L35	DVDD	V34	CE1
B14	LD3	D14	LD9	F24	A6	M2	LA18	W1	X1
B16	A30	D16	LD5	F26	A11	M4	LA19	W3	IACK
B18	A27	D18	LD2	F28	A5	M6	LA11	W5	LSTAT3
B20	A25	D20	A29	F32	D31	M30	D17	W31	RDY1
B22	A21	D22	A24	F34	D23	M32	D14	W33	LOCK
B24	A17	D24	A20	G1	DVSS	M34	D9	W35	TMS
B26	A14	D26	A15	G3	LA7	N1	CVSS	Y2	LSTAT2
B28	A10	D28	A9	G5	LA6	N3	LA20	Y4	LSTAT1
B30	A4	D30	A2	G31	D27	N5	LA21	Y32	RDY0
B32	A1	D32	A0	G33	D21	N31	D12	Y34	TCK
B34	LADVDD	D34	D26	G35	DVSS	N33	D7		
						N35	DVSS		



memory map

Figure 1 shows the memory map for the '320C40. Refer to the *TMS320C4x User's Guide* (literature number SPRU063B) for a detailed description of this memory mapping.

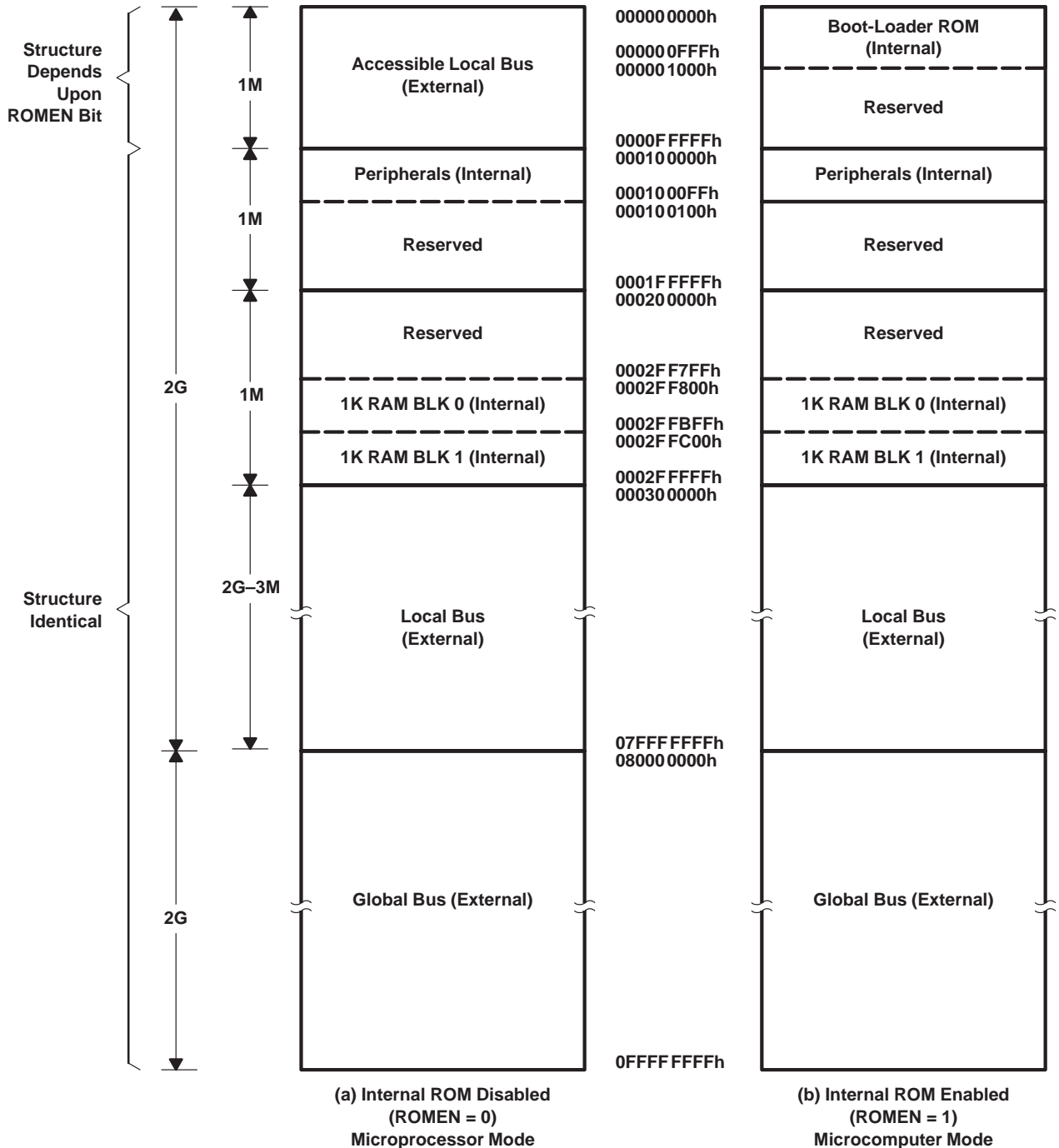

Figure 1. Memory Map for '320C40

TMS320C40

DIGITAL SIGNAL PROCESSOR

SPRS038 – JANUARY 1996

description

The '320C40 digital signal processors (DSPs) are 32-bit, floating-point processors manufactured in 0.72- μ m, double-level metal CMOS technology. The '320C40 is a part of the fourth generation of DSPs from Texas Instruments and is designed primarily for parallel processing.

operation

The '320C40 has six on-chip communication ports for processor-to-processor communication with no external hardware and simple communication software. This allows connectivity to other 'C4x processors with no external-glue logic. The communication ports remove input/output bottlenecks, and the independent smart DMA coprocessor is able to handle the CPU input/output burden.

central processing unit

The '320C40 CPU is configured for high-speed internal parallelism for the highest sustained performance. The key features of the CPU are:

- Eight operations/cycle:
 - 40/32-bit floating-point/integer multiply
 - 40/32-bit floating-point/integer ALU operation
 - Two data accesses
 - Two address register updates
- IEEE floating-point conversion
- Divide and square-root support
- 'C3x assembly language compatibility
- Byte and halfword accessibility

DMA coprocessor

The DMA coprocessor allows concurrent I/O and CPU processing for the highest sustained CPU performance. The key features of the DMA processor are:

- Link pointers allow DMA channels to auto-initialize without CPU intervention.
- Parallel CPU operation and DMA transfers
- Six DMA channels support memory-to-memory data transfers.
- Split-mode operation doubles the available DMA channel to 12 when data transfers to and from a communication port are required.

communication ports

The '320C40 is the first DSP with on-chip communication ports for processor-to-processor communication with no external hardware and simple communication software. The features of the communication ports are:

- Direct interprocessor communication and processor I/O
- Six communication ports for direct interprocessor communication and processor I/O
- 20M-bytes/s bidirectional interface on each communication port for high-speed multiprocessor interface
- Separate input and output 8-word-deep FIFO buffers for processor-to-processor communication and I/O
- Automatic arbitration and handshaking for direct processor-to-processor connection



communication-port software reset ('C40 silicon revision \geq 5.0)

The input and output FIFO levels for a communication port can be flushed by writing at least two back-to-back values to its communication-port-software reset address as specified in Table 1. This feature is not present in 'C40 silicon revision $<$ 5.0. This software reset flushes any word or byte already present in the FIFOs but it does not affect the status of the communication-port pins. Figure 2 shows an example of communication-port-software reset.

Table 1. Communication-Port Software-Reset Address

COMMUNICATION PORT	SOFTWARE RESET ADDRESS
0	0x0100043
1	0x0100053
2	0x0100063
3	0x0100073
4	0x0100083
5	0x0100093

```

; -----;
; RESET1:Flush's FIFO data for communication port 1;
; -----;
RESET1 push  AR0          ; Save registers
      push  R0           ;
      push  RC           ;
      ldhi  010h,AR0     ; Set AR0 to base address of COM 1
      or   050h,AR0     ;
flush: rpts  1           ; Flush FIFO data with back-to-back write
      sti  R0, *+AR0(3) ;
      rpts 10           ; Wait
      nop                    ;
      ldi  *+AR0(0),R0    ; Check for new data from other port
      and  01FE0h,R0     ;
      bnz  flush         ;
      pop  RC            ; Restore registers
      pop  R0           ;
      pop  AR0          ;
      rets                ; Return

```

Figure 2. Example of Communication-Port-Software Reset

$\overline{\text{NMI}}$ with bus-grant feature ('C40 silicon revision ≥ 5.0)

The '320C40 devices have a software-configurable feature which allows forcing the internal-peripheral bus to ready when the $\overline{\text{NMI}}$ signal is asserted. This feature is not present in 'C40 silicon revision < 5.0 . The $\overline{\text{NMI}}$ bus-grant feature is enabled when bits 19–18 of the status register (ST) are set to 10b. When enabled, a peripheral bus-grant signal is generated on the falling edge of $\overline{\text{NMI}}$. When $\overline{\text{NMI}}$ is asserted and this feature is not enabled, the CPU stalls on access to the peripheral bus if it is not ready. A stall condition occurs when writing to a full FIFO or reading an empty FIFO. This feature is useful in correcting communication-port errors when used in conjunction with the communication-port software-reset feature.

IDLE2 clock-stop power-down mode ('C40 silicon revision ≥ 5.0)

The '320C40 has a clock-stop mode or power-down mode (IDLE2) to achieve extremely low-power consumption. When an IDLE2 instruction is executed, the clocks are halted with H1 being held high. To exit IDLE2, assert one of the $\overline{\text{IIOF3}}$ – $\overline{\text{IIOF0}}$ pins configured as an external interrupt instead of a general-purpose I/O. A macro showing how to generate the IDLE2 opcode is given in Figure 3. During this power-down mode:

- No instructions are executed.
- The CPU, peripherals, and internal memory retain their previous state.
- The external-bus outputs are idle. The address lines remain in their previous state, the data lines are in the high-impedance state, and the output-control signals are inactive.

```
; -----;
; IDLE2: Macro to generate idle2 opcode      ;
; -----;
IDLE2      .macro
           .word      06000001h
           .endm
```

Figure 3. Example of Software Subroutine Using IDLE2

IDLE2 is exited when one of the five external interrupts ($\overline{\text{NMI}}$ and $\overline{\text{IIOF3}}$ – $\overline{\text{IIOF0}}$) is asserted low for at least four input clocks (two H1 cycles). The clocks then start after a delay of two input clocks (one H1 cycle). The clocks can start in the opposite phase; that is, H1 can be high when H3 was high before the clocks were stopped. However, the H1 and H3 clocks remain 180° out of phase with each other.

During IDLE2 operation, an external interrupt can be recognized and serviced by the CPU if it is enabled before entering IDLE2 and asserted for at least two H1 cycles. For the processor to recognize only one interrupt, the interrupt pin must be configured for edge-trigger mode or asserted less than three cycles in level-trigger mode. Any external interrupt pin can wake up the device from IDLE2, but for the CPU to recognize that interrupt, it must also be enabled. If an interrupt is recognized and executed by the CPU, the instruction following the IDLE2 instruction is not executed until after execution of a return opcode.

When the device is in emulation mode, the CPU executes an IDLE2 instruction as if it were an IDLE instruction. The clocks continue to run for correct operation of the emulator.

development tools

The 'C40 is supported by a host of parallel-processing development tools for developing and simulating code easily and for debugging parallel-processing systems. The code generation tools include:

- An ANSI C compiler optimized with a runtime support library that supports use of communication ports and DMA.
- Third party support for C, C++ and Ada compilers
- Several operating systems available for parallel-processing support, as well as DMA and communication port drivers
- An assembler and linker with support for mapping program and data to parallel processors

The simulation tools include:

- Parallel DSP system-level simulation with LAI hardware verification (HV) model and full function (FF) model.
- TI software simulator with high-level language debugger interface for simulating a single processor.

The hardware development and verification tools include:

- Parallel processor in-circuit emulator and high-level language debugger: XDS510.
- Parallel processor development system (PPDS) with four '320C40s, local and global memory, and communication port connections.

silicon revision identification

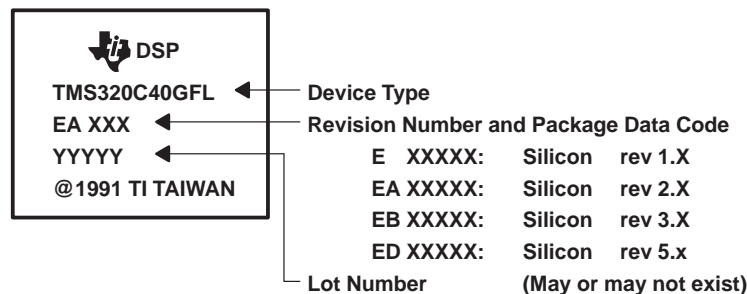

TMS320C40 DIGITAL SIGNAL PROCESSOR

SPRS038 – JANUARY 1996

absolute maximum ratings over specified temperature range (unless otherwise noted)[†]

Supply voltage range, V_{DD} (see Note 1)	– 0.3 V to 7 V
Voltage range on any pin	– 0.3 V to 7 V
Output voltage range	– 0.3 V to 7 V
Operating case temperature range, T_C	0°C to 85°C
Storage temperature range, T_{stg}	– 55°C to 150°C

[†] Stresses beyond those listed under “absolute maximum ratings” may cause permanent damage to the device. These are stress ratings only, and functional operation of the device at these or any other conditions beyond those indicated under “recommended operating conditions” is not implied. Exposure to absolute-maximum-rated conditions for extended periods may affect device reliability.

NOTE 1: All voltage values are with respect to V_{SS} .

recommended operating conditions (see Note 2)

		MIN	TYP [‡]	MAX	UNIT
V_{DD}	Supply voltages (DD V_{DD} , etc.)	4.75	5	5.25	V
V_{IH}	High-level input voltage	X2/CLKIN	2.6	$V_{DD} + 0.3$ [§]	V
		All other pins	2	$V_{DD} + 0.3$ [§]	
V_{IL}	Low-level input voltage	– 0.3 [§]		0.8	V
I_{OH}	High-level output current			– 300	μ A
I_{OL}	Low-level output current			2	mA
T_C	Operating case temperature			85	°C

[‡] All typical values are at $V_{DD} = 5$ V, T_A (ambient air temperature) = 25°C.

[§] This parameter is characterized but not tested.

NOTE 2: All input and output voltage levels are TTL compatible, except for CLKIN. CLKIN can be driven by CMOS clock.

electrical characteristics over recommended ranges of supply voltage and operating case temperature (unless otherwise noted)

PARAMETER	TEST CONDITIONS	MIN	TYP ^{††}	MAX	UNIT
V_{OH}	High-level output voltage $V_{DD} = \text{MIN}, I_{OH} = \text{MAX}$	2.4	3		V
V_{OL}	Low-level output voltage $V_{DD} = \text{MIN}, I_{OL} = \text{MAX}$		0.3	0.6	V
I_Z	Three-state current $V_{DD} = \text{MAX}$	– 20		20	μ A
I_{IC}	Input current, X2/CLKIN only $V_I = V_{SS}$ to V_{DD}	– 30		30	μ A
I_{IP}	Input current Inputs with internal pullups (See Note 3)	– 400		20	μ A
I_I	Input current $V_I = V_{SS}$ to V_{DD}	– 10		10	μ A
I_{CC}	Supply current $T_A = 25^\circ\text{C}, V_{DD} = \text{MAX}, f_X = \text{MAX}$ (See Note 4)	'320C40-40	350	850	mA
		'320C40-50		950	
		'320C40-60			
C_I	Input capacitance			15 [#]	pF
C_O	Output capacitance			15 [#]	pF

^{††} All typical values are at $V_{DD} = 5$ V, T_A (ambient air temperature) = 25°C.

[#] This parameter is specified by design but not tested.

NOTES: 3. Pins with internal pullup devices: TDI, TCK, TMS. Pin with internal pulldown device: $\overline{\text{TRST}}$.

4. f_X is the input clock frequency. The maximum value (max) for the '320C40-40, '320C40-50, and '320C40-60 is 40, 50 and 60 MHz, respectively.



PARAMETER MEASUREMENT INFORMATION

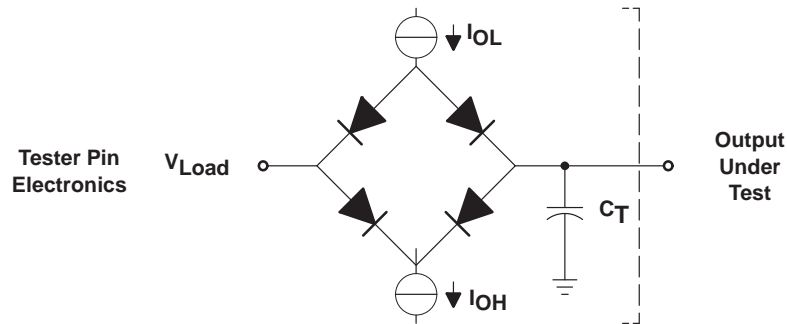

Where: I_{OL} = 2 mA (all outputs)
 I_{OH} = 300 μ A (all outputs)
 V_{Load} = 2.15 V
 C_T = 80 pF typical load circuit capacitance.

Figure 4. Test Load Circuit

signal transition levels

TTL-level outputs are driven to a minimum logic-high level of 2.4 V and to a maximum logic-low level of 0.6 V. Output transition times are specified as follows.

For a high-to-low transition on a TTL-compatible output signal, the level at which the output is said to be no longer high is 2 V and the level at which the output is said to be low is 1 V. For a low-to-high transition, the level at which the output is said to be no longer low is 1 V and the level at which the output is said to be high is 2 V. See Figure 5.

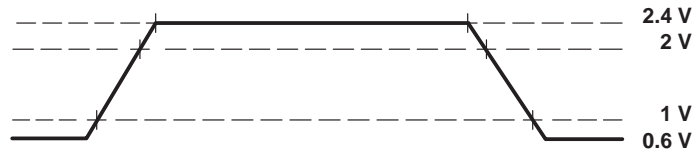

Figure 5. TTL-Level Outputs

Transition times for TTL-compatible inputs are specified as follows. For a high-to-low transition on an input signal, the level at which the input is said to be no longer high is 2 V and the level at which the input is said to be low is 0.8 V. For a low-to-high transition on an input signal, the level at which the input is said to be no longer low is 0.8 V and the level at which the input is said to be high is 2 V. See Figure 6.



Figure 6. TTL-Level Inputs

PARAMETER MEASUREMENT INFORMATION

timing parameter symbology

Timing parameter symbols used herein were created in accordance with JEDEC Standard 100-A. In order to shorten the symbols, pin names that have both global and local applications are generally represented with (L) immediately preceding the basic signal name (for example, (L)RDYx represents both the global term RDYx and local term LRDYx). Other pin names and related terminology have been abbreviated as follows, unless otherwise noted:

A	(L)A30–(L)A0 or (L)Ax	IACK	$\overline{\text{IACK}}$
AE	$\overline{\text{(L)AE}}$	IF	$\overline{\text{IIOF(3–0)}}$ or $\overline{\text{IIOF}x}$
ASYNCH	Asynchronous reset signals in the high-impedance state	IIOF	$\overline{\text{IIOF(3–0)}}$ or $\overline{\text{IIOF}x}$
BYTE	Byte transfer	LOCK	$\overline{\text{(L)LOCK}}$
CA	$\overline{\text{CACK(0–5)}}$ or $\overline{\text{CACK}x}$	P	$t_{c(H)}$
CD	C(0–5)D7–C(0–5)D0 or CxDx	PAGE	(L)PAGE0 and (L)PAGE1 or (L)PAGEx
CE	$\overline{\text{(L)CE0}}$, $\overline{\text{(L)CE1}}$, or $\overline{\text{(L)CE}x}$	RDY	$\overline{\text{(L)RDY0}}$, $\overline{\text{(L)RDY1}}$, or $\overline{\text{(L)RDY}x}$
CI	CLKIN	RESET	$\overline{\text{RESET}}$
COMM	Asynchronous reset signals	RW	(L)R/ $\overline{\text{W0}}$, (L)R/ $\overline{\text{W1}}$, or (L)R/ $\overline{\text{W}x}$
CONTROL	Control signals	S	$\overline{\text{(L)STRB0}}$, $\overline{\text{(L)STRB1}}$ or $\overline{\text{(L)STRB}x}$
CRQ	$\overline{\text{CREQ(0–5)}}$ or $\overline{\text{CREQ}x}$	ST	(L)STAT3–(L)STAT0 or (L)STATx
CRDY	$\overline{\text{CRDY(0–5)}}$ or $\overline{\text{CRDY}x}$	TCK	TCK
CS	$\overline{\text{CSTRB(0–5)}}$ or $\overline{\text{CSTRB}x}$	TCLK	TCLK0, TCLK1, or TCLKx
D	(L)D31–(L)D0 or (L)Dx	TDO	TDO
DE	$\overline{\text{(L)DE}}$	TMS	TMS/TDI
H	H1, H3	WORD	32-bit word transfer

timing for X2/CLKIN, H1, H3 (see Figure 7 and Figure 8)

NO.		TMS320C40-40		TMS320C40-50		TMS320C40-60		UNIT
		MIN	MAX	MIN	MAX	MIN	MAX	
1	$t_f(\text{Cl})$ Fall time, CLKIN		5†		5†		5†	ns
2	$t_w(\text{ClL})$ Pulse duration, CLKIN low, $t_c(\text{Cl}) = \text{MIN}$	8		7		5		ns
3	$t_w(\text{ClH})$ Pulse duration, CLKIN high, $t_c(\text{Cl}) = \text{MIN}$	8		7		5		ns
4	$t_r(\text{Cl})$ Rise time, CLKIN		5†		5†		5†	ns
5	$t_c(\text{Cl})$ Cycle time, CLKIN	25	242.5	20	242.5	16.67	242.5	ns
6	$t_f(\text{H})$ Fall time, H1 and H3		3		3		3	ns
7	$t_w(\text{HL})$ Pulse duration, H1 and H3 low	$t_c(\text{Cl}) - 6$	$t_c(\text{Cl}) + 6$	$t_c(\text{Cl}) - 6$	$t_c(\text{Cl}) + 6$	$t_c(\text{Cl}) - 6$	$t_c(\text{Cl}) + 6$	ns
8	$t_w(\text{HH})$ Pulse duration, H1 and H3 high	$t_c(\text{Cl}) - 6$	$t_c(\text{Cl}) + 6$	$t_c(\text{Cl}) - 6$	$t_c(\text{Cl}) + 6$	$t_c(\text{Cl}) - 6$	$t_c(\text{Cl}) + 6$	ns
9	$t_r(\text{H})$ Rise time, H1 and H3		4		4		4	ns
9.1	$t_d(\text{HL-HH})$ Delay time from H1 low to H3 high or from H3 low to H1 high	-1	4	-1	4	-1	4	ns
10	$t_c(\text{H})$ Cycle time, H1 and H3	50	485	40	485	33.3	485	ns

† This value is specified by design but not tested.

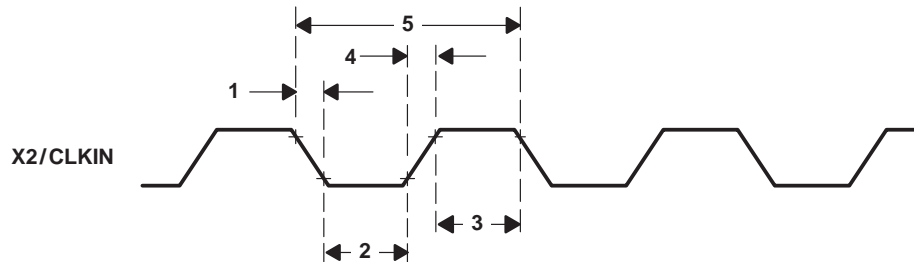

Figure 7. X2/CLKIN Timing

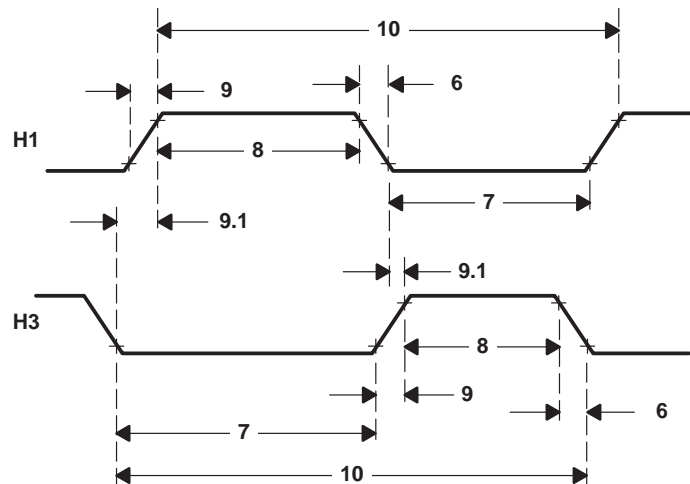

Figure 8. H1 and H3 Timings

TMS320C40 DIGITAL SIGNAL PROCESSOR

SPRS038 – JANUARY 1996

memory-read-cycle and memory-write-cycle timing [$\overline{(L)STRBx} = 0$] (see Note 5, Figure 9 and Figure 10)

NO.		TMS320C40-40		TMS320C40-50		TMS320C40-60		UNIT
		MIN	MAX	MIN	MAX	MIN	MAX	
1	$t_{d(H1L-SL)}$ Delay time, H1 low to $\overline{(L)STRBx}$ low	0†	9	0†	9	0†	8	ns
2	$t_{d(H1L-SH)}$ Delay time, H1 low to $\overline{(L)STRBx}$ high	0†	9	0†	9	0†	8	ns
3	$t_{d(H1H-RWL)}$ Delay time, H1 high to $(L)R/\overline{Wx}$ low	0†	9	0†	9	0†	8	ns
4	$t_{d(H1L-A)}$ Delay time, H1 low to $(L)Ax$ valid	0†	9	0†	9	0†	8	ns
5	$t_{su(D-H1L)R}$ Setup time, $(L)Dx$ valid before H1 low (read)	15		10		9		ns
6	$t_h(H1L-D)R$ Hold time, $(L)Dx$ after H1 low (read)	0		0		0		ns
7	$t_{su(RDY-H1L)}$ Setup time, $\overline{(L)RDYx}$ valid before H1 low	25‡		20‡		18†		ns
8	$t_h(H1L-RDY)$ Hold time, $\overline{(L)RDYx}$ after H1 low	0		0		0		ns
8.1	$t_{d(H1L-ST)}$ Delay time, H1 low to $(L)STAT3-(L)STAT0$ valid		9		8		8	ns
9	$t_{d(H1H-RWH)W}$ Delay time, H1 high to $(L)R/\overline{Wx}$ high (write)	0†	9	0†	9	0†	8	ns
10	$t_v(H1L-D)W$ Valid time, $(L)Dx$ after H1 low (write)		16		16		13	ns
11	$t_h(H1H-D)W$ Hold time, $(L)Dx$ after H1 high (write)	0		0		0		ns
12	$t_{d(H1H-A)}$ Delay time, H1 high to address valid on back-to-back write cycles		13		9		8	ns

† This value is specified by design but not tested.

‡ If this setup time is not met, the read/write operation is not assured.

NOTE 5: For consecutive reads, $(L)R/\overline{Wx}$ stays high and $\overline{(L)STRBx}$ stays low.



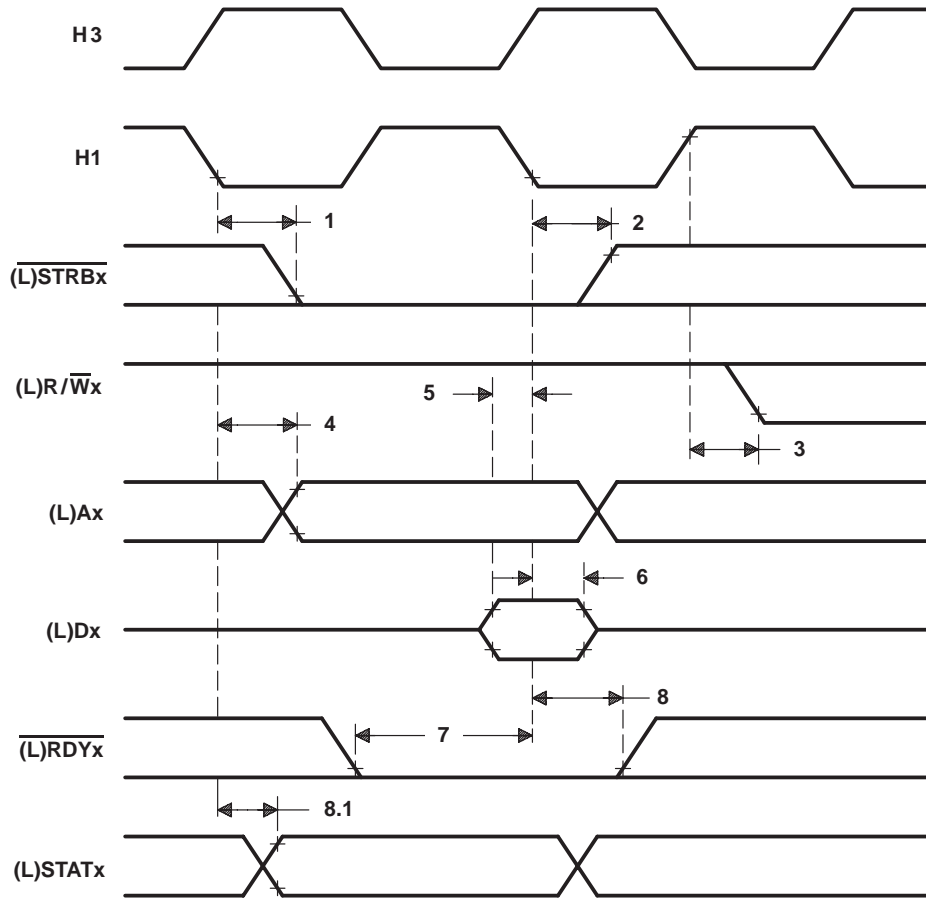

Figure 9. Memory-Read-Cycle Timing [(L)STRBx = 0]

TMS320C40 DIGITAL SIGNAL PROCESSOR

SPRS038 – JANUARY 1996

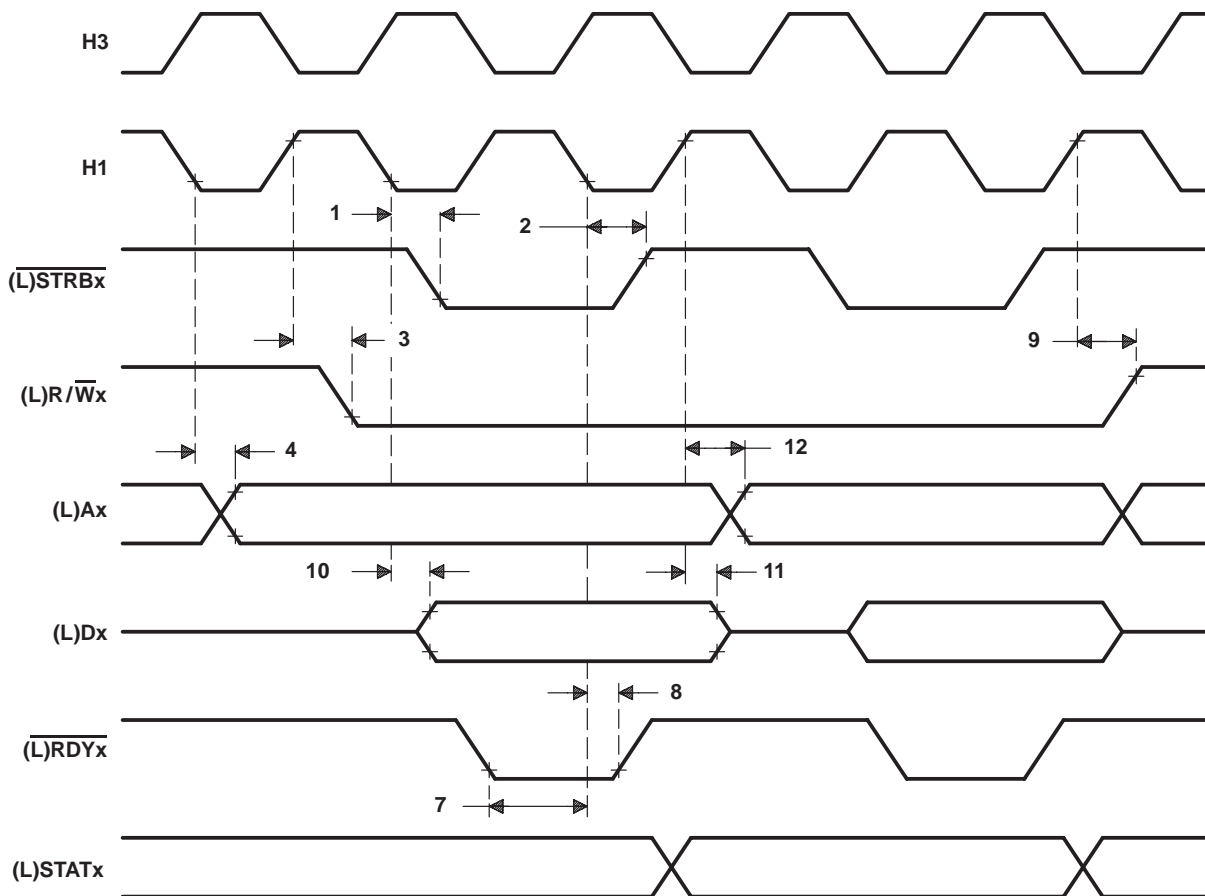

Figure 10. Memory-Write-Cycle Timing [(L)STRBx = 0]

(L)DE-, (L)AE-, and (L)CEx-enable timing (see Figure 11)

NO.		TMS320C40-40 TMS320C40-50	TMS320C40-60		UNIT	
			MIN	MAX		MIN
1	$t_{d(DEH-DZ)}$ Delay time, $\overline{(L)DE}$ high to (L)D0–(L)D31 in the high-impedance state	0†	15‡	0†	15‡	ns
2	$t_{d(DEL-DV)}$ Delay time, $\overline{(L)DE}$ low to (L)D0–(L)D31 valid	0†	21	0†	16	ns
3	$t_{d(AEH-AZ)}$ Delay time, $\overline{(L)AE}$ high to (L)A0–(L)A30 in the high-impedance state	0†	15‡	0†	15‡	ns
4	$t_{d(AEL-AV)}$ Delay time, $\overline{(L)AE}$ low to (L)A0–(L)A30 valid	0†	18	0†	16	ns
5	$t_{d(CEH-RWZ)}$ Delay time, $\overline{(L)CEx}$ high to (L)R/ \overline{W} 0, (L)R/ \overline{W} 1 in the high-impedance state	0†	15‡	0†	15‡	ns
6	$t_{d(CEL-RWV)}$ Delay time, $\overline{(L)CEx}$ low to (L)R/ \overline{W} 0, (L)R/ \overline{W} 1 valid	0†	21	0†	16	ns
7	$t_{d(CEH-SZ)}$ Delay time, $\overline{(L)CEx}$ high to (L)STRB0, (L)STRB1 in the high-impedance state	0†	15‡	0†	15‡	ns
8	$t_{d(CEL-SV)}$ Delay time, $\overline{(L)CEx}$ low to (L)STRB0, (L)STRB1 valid	0†	21	0†	16	ns
9	$t_{d(CEH-PAGEZ)}$ Delay time, $\overline{(L)CEx}$ high to (L)PAGE0, (L)PAGE1 in the high-impedance state	0†	15‡	0†	15‡	ns
10	$t_{d(CEL-PAGEV)}$ Delay time, $\overline{(L)CEx}$ low to (L)PAGE0, (L)PAGE1 valid	0†	21	0†	16	ns

† This value is specified by design but not tested.

‡ This value is characterized but not tested.

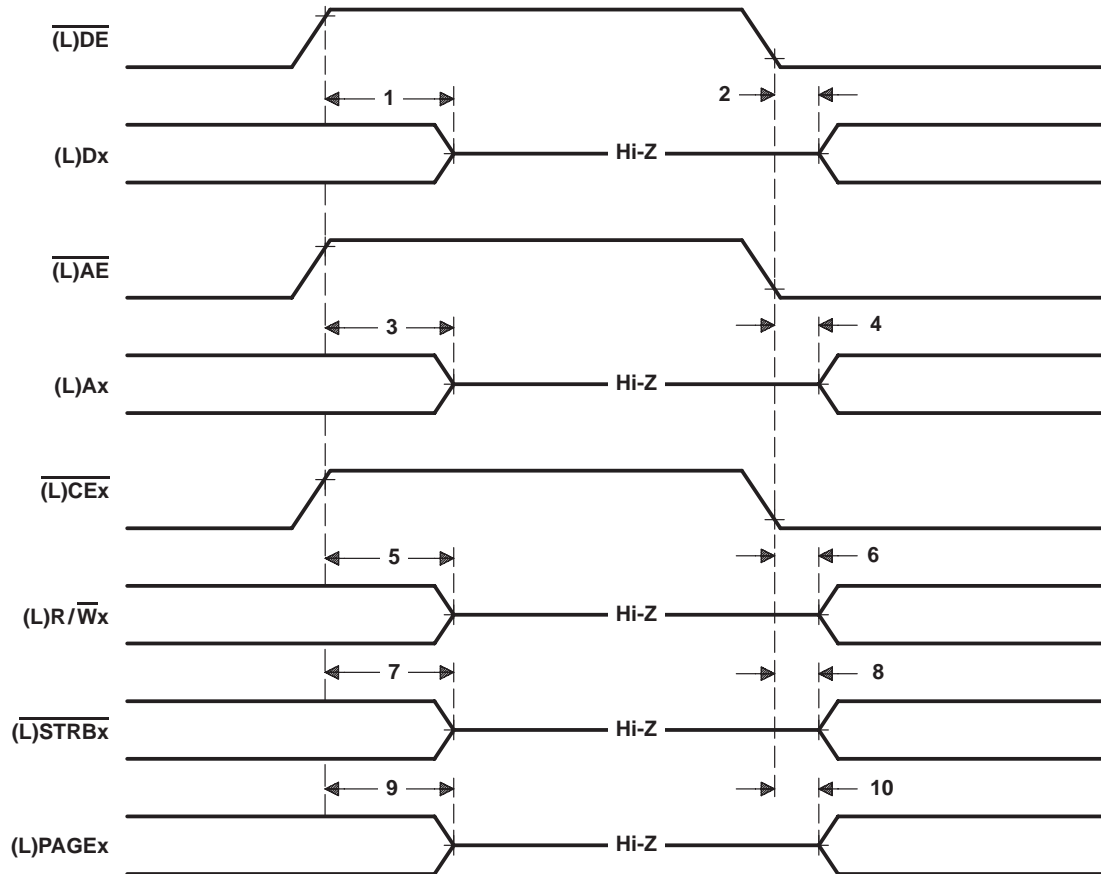

Figure 11. (L)DE-, (L)AE-, and (L)CEx-Enable Timings

TMS320C40 DIGITAL SIGNAL PROCESSOR

SPRS038 – JANUARY 1996

timing for $\overline{\text{(L)LOCK}}$ when executing LDFI or LDII (see Figure 12)

NO.		TMS320C40-40		TMS320C40-50		TMS320C40-60		UNIT
		MIN	MAX	MIN	MAX	MIN	MAX	
1	$t_{d(\text{H1L}-\text{LOCKL})}$ Delay time, H1 low to $\overline{\text{(L)LOCK}}$ low		11		8		8	ns

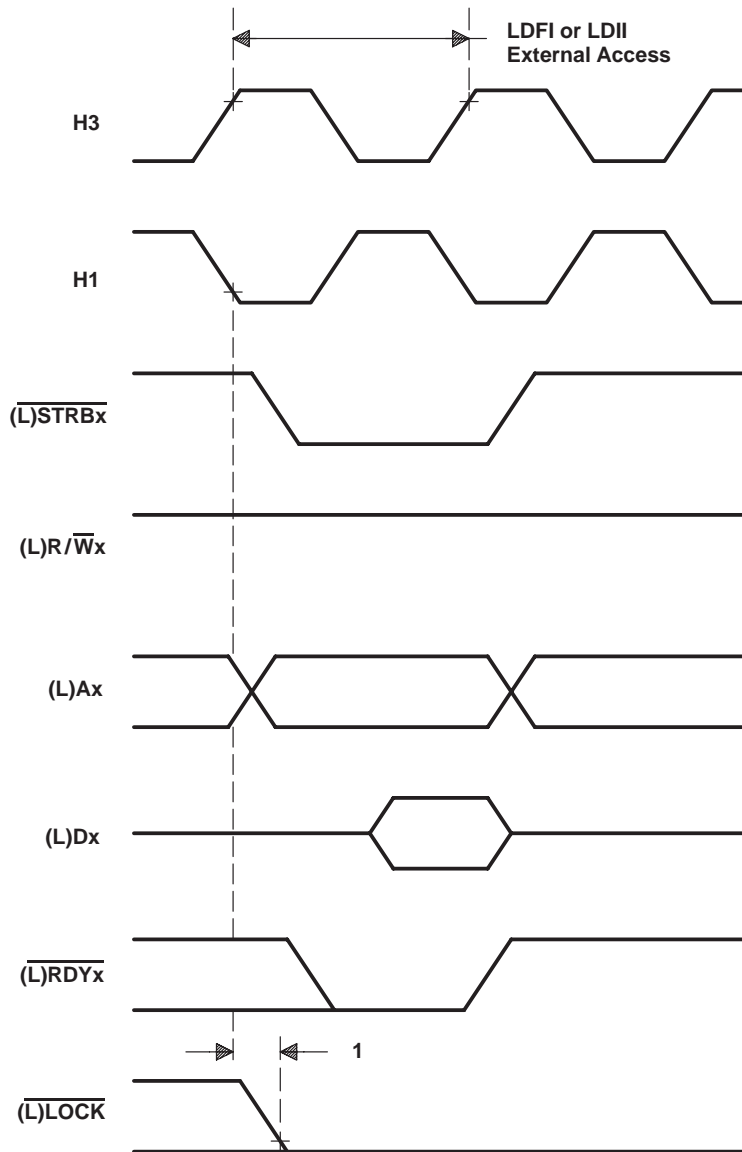

Figure 12. Timing for $\overline{\text{(L)LOCK}}$ When Executing LDFI or LDII

timing for $\overline{(L)LOCK}$ when executing STFI or STII (see Figure 13)

NO.		TMS320C40-40		TMS320C40-50		TMS320C40-60		UNIT
		MIN	MAX	MIN	MAX	MIN	MAX	
1	$t_{d(H1L-LOCKH)}$ Delay time, H1 low to $\overline{(L)LOCK}$ high		11		8		8	ns

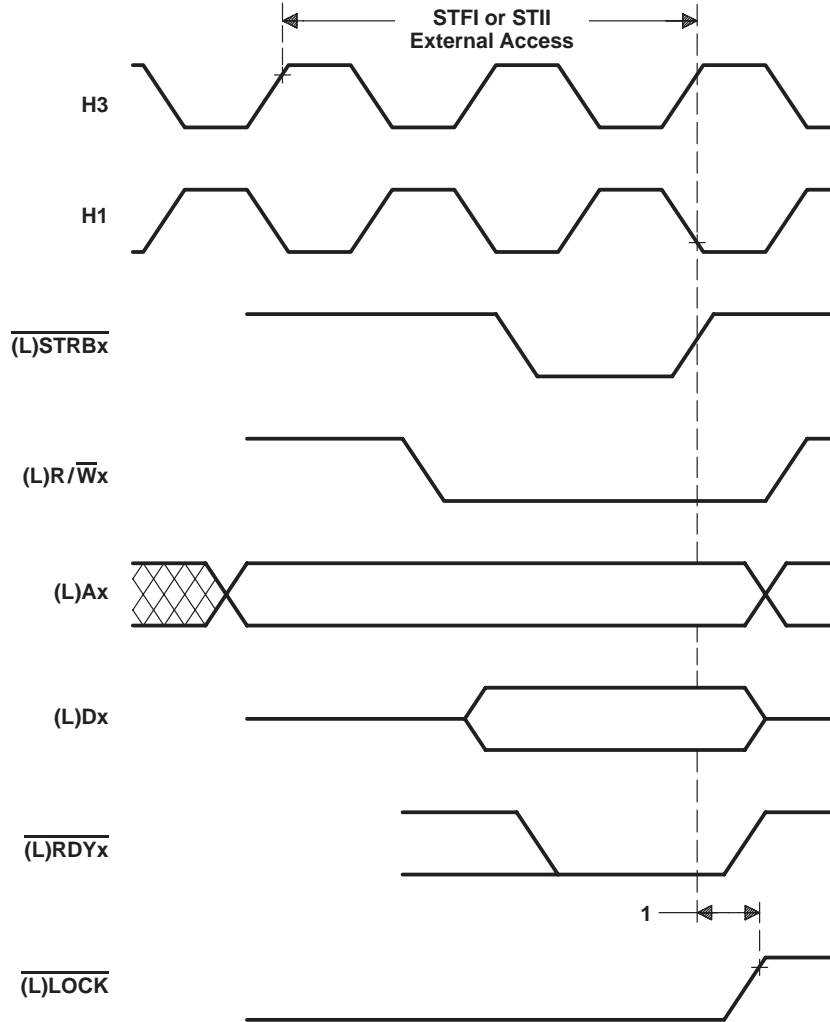

Figure 13. Timing for $\overline{(L)LOCK}$ When Executing STFI or STII

TMS320C40 DIGITAL SIGNAL PROCESSOR

SPRS038 – JANUARY 1996

timing for $\overline{(L)LOCK}$ when executing SIGI (see Figure 14)

NO.		TMS320C40-40		TMS320C40-50		TMS320C40-60		UNIT
		MIN	MAX	MIN	MAX	MIN	MAX	
1	$t_{d(H1L-LOCKL)}$ Delay time, H1 low to $\overline{(L)LOCK}$ low		11		8		8	ns
2	$t_{d(H1L-LOCKH)}$ Delay time, H1 low to $\overline{(L)LOCK}$ high		11		8		8	

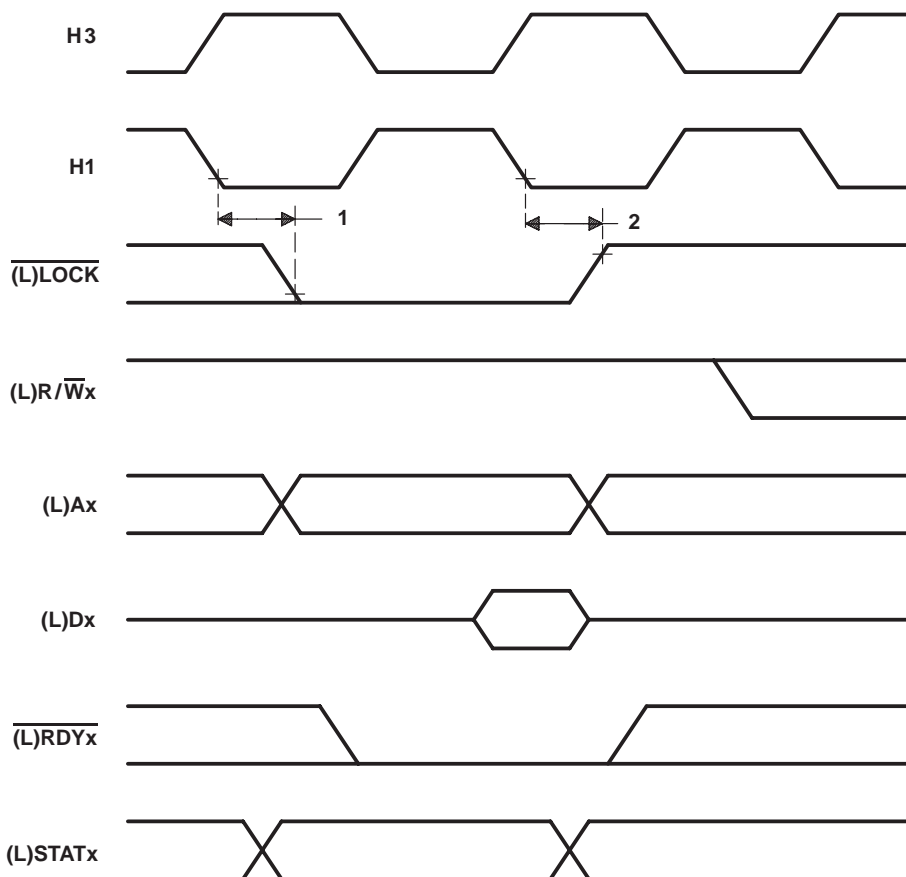

Figure 14. Timing for $\overline{(L)LOCK}$ When Executing SIGI

timing for (L)PAGE0, (L)PAGE1 during memory access to a different page (see Figure 15)

NO.		TMS320C40-40 TMS320C40-50		TMS320C40-60		UNIT
		MIN	MAX	MIN	MAX	
1	$t_{d(H1L-PAGEH)}$ Delay time, H1 low to (L)PAGEx high for access to different page	0	9	0	8	ns
2	$t_{d(H1L-PAGEL)}$ Delay time, H1 low to (L)PAGEx low for access to different page	0	9	0	8	ns

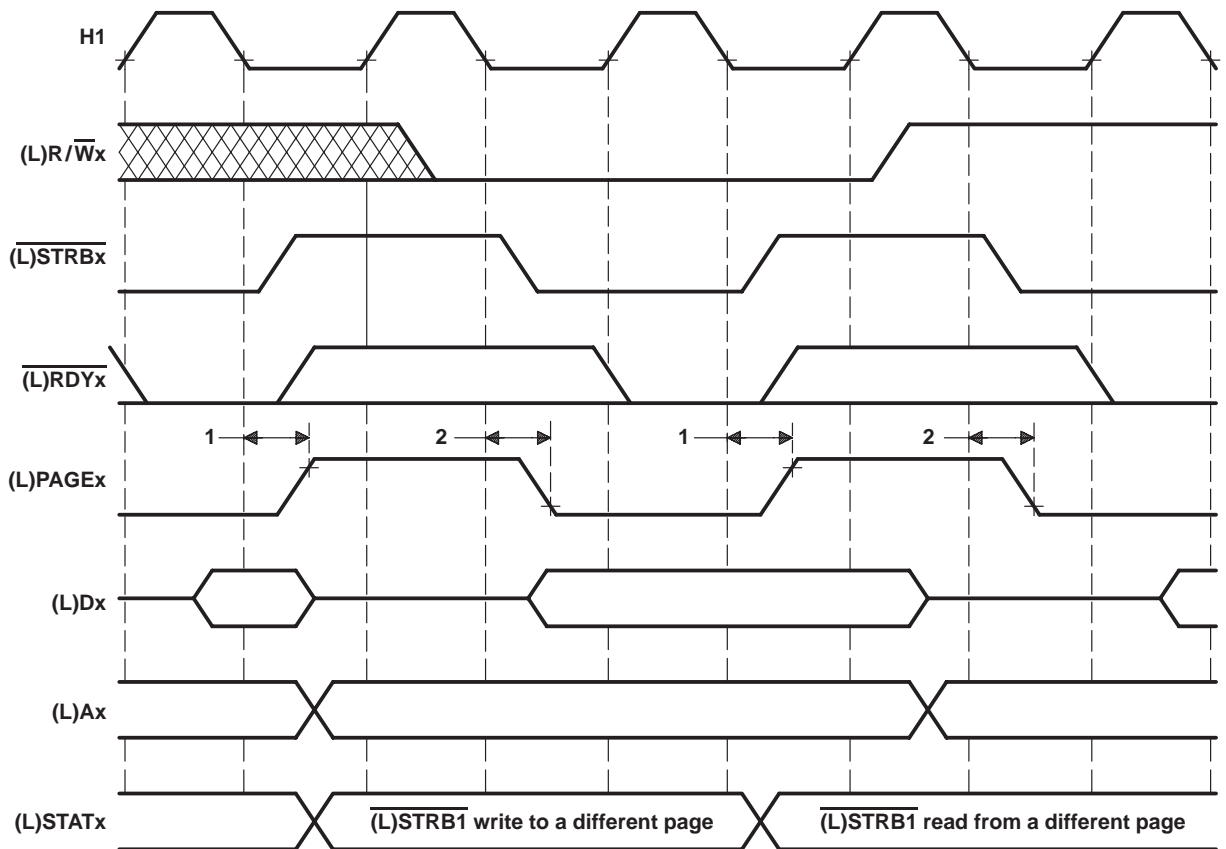

Figure 15. (L)PAGE0, (L)PAGE1 Timing Cycle, Memory Access to a Different Page

TMS320C40 DIGITAL SIGNAL PROCESSOR

SPRS038 – JANUARY 1996

timing for the $\overline{\text{IIOF}}_x$ when configured as an output (see Figure 16)

NO.		TMS320C40-40		TMS320C40-50		TMS320C40-60		UNIT
		MIN	MAX	MIN	MAX	MIN	MAX	
1	$t_{V(H1L-IIOF)}$ H1 low to $\overline{\text{IIOF}}_x$ valid		16		14		14	ns

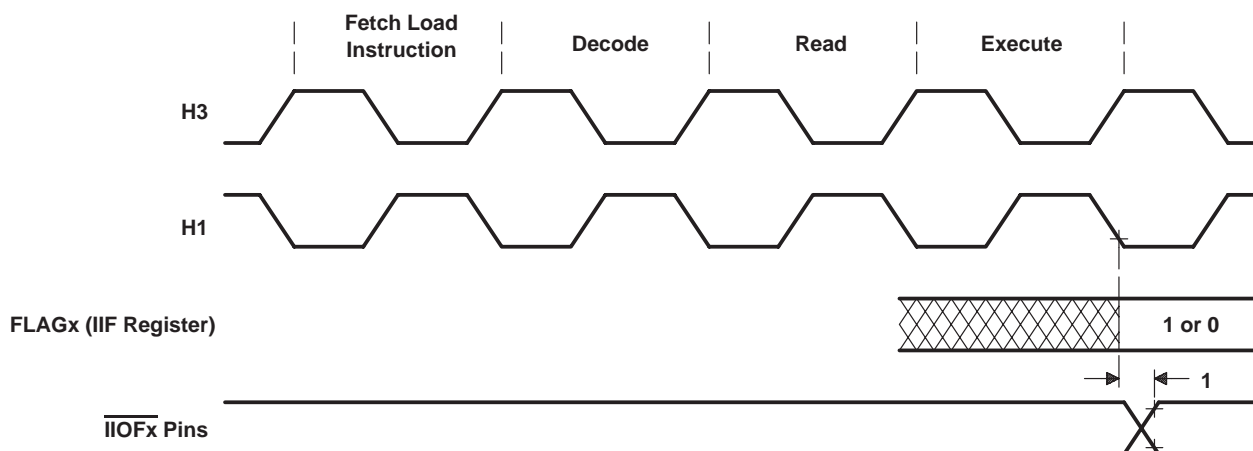

Figure 16. Timing for the $\overline{\text{IIOF}}_x$ When Configured as an Output

timing of $\overline{\text{IIOF}}_x$ changing from output to input mode (see Figure 17)

NO.		TMS320C40-40 TMS320C40-50		TMS320C40-60		UNIT
		MIN	MAX	MIN	MAX	
1	$t_h(\text{H1L}-\overline{\text{IIOF}}_x)$ Hold time, $\overline{\text{IIOF}}_x$ after H1 low		14†		14†	ns
2	$t_{su}(\overline{\text{IIOF}}_x\text{-H1L})$ Setup time, $\overline{\text{IIOF}}_x$ before H1 low	11		11		ns
3	$t_h(\text{H1L}-\overline{\text{IIOF}}_x)$ Hold time, $\overline{\text{IIOF}}_x$ after H1 low	0		0		ns

† This value is specified by design but not tested.

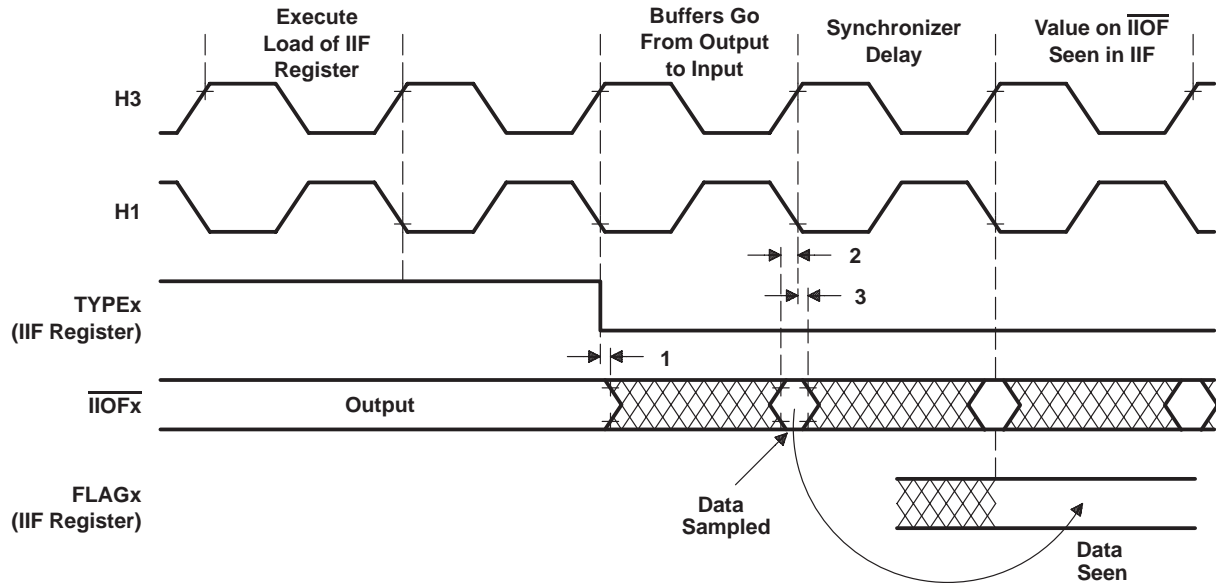

Figure 17. Change of $\overline{\text{IIOF}}_x$ From Output to Input Mode

TMS320C40 DIGITAL SIGNAL PROCESSOR

SPRS038 – JANUARY 1996

timing of $\overline{\text{IIOF}}_x$ changing from input to output mode (see Figure 18)

NO.		TMS320C40-40		TMS320C40-50		TMS320C40-60		UNIT
		MIN	MAX	MIN	MAX	MIN	MAX	
1	$t_{d(H1L-IFIO)}$ Delay time, H1 low to $\overline{\text{IIOF}}_x$ switching from input to output		16		14		14	ns

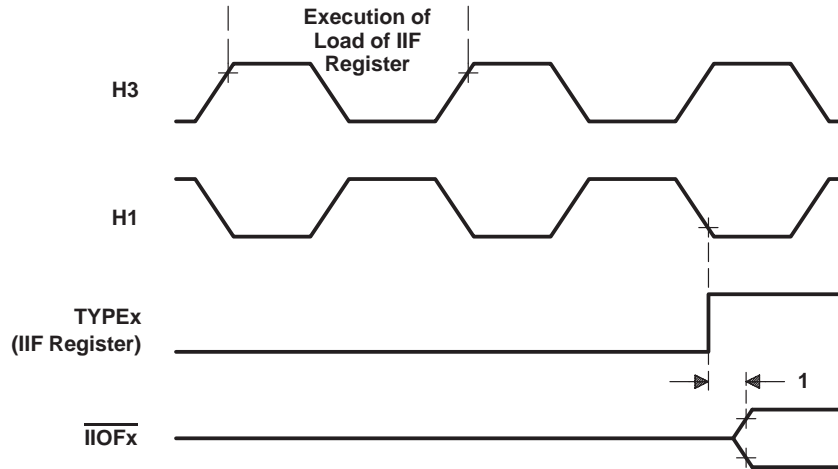

Figure 18. Change of $\overline{\text{IIOF}}_x$ From Input to Output Mode

RESET timing (see Figure 19)

NO.		TMS320C40-40		TMS320C40-50		TMS320C40-60		UNIT
		MIN	MAX	MIN	MAX	MIN	MAX	
1	$t_{su(RESET-C1L)}$ Setup time for $\overline{\text{RESET}}$ before CLKIN low	11	$t_{c(CI)}^\dagger$	11	$t_{c(CI)}^\dagger$	11	$t_{c(CI)}^\dagger$	ns
2.1	$t_{d(CIH-H1H)}$ Delay time, CLKIN high to H1 high	3	10	2	10	2	10	ns
2.2	$t_{d(CIH-H1L)}$ Delay time, CLKIN high to H1 low	3	10	2	10	2	10	ns
3	$t_{su(RESETH-H1L)}$ Setup time for $\overline{\text{RESET}}$ high before H1 low and after ten H1 clock cycles	13		13		13		ns
4.1	$t_{d(CIH-H3L)}$ Delay time, CLKIN high to H3 low	3	10	2	10	2	10	ns
4.2	$t_{d(CIH-H3H)}$ Delay time, CLKIN high to H3 high	3	10	2	10	2	10	ns
5	$t_{d(H1H-DZ)}$ Delay time, H1 high to (L)Dx in the high-impedance state		13‡		13‡		13‡	ns
6	$t_{d(H3H-AZ)}$ Delay time, H3 high to (L)Ax in the high-impedance state		9‡		9‡		9‡	ns
7	$t_{d(H3H-CONTROLH)}$ Delay time, H3 high to control signals high [low for (L)PAGE]		9‡		9‡		9‡	ns
8	$t_{d(H1H-IACKH)}$ Delay time, H1 high to $\overline{\text{IACK}}$ high		9‡		9‡		9‡	ns
9	$t_{d(RESETL-ASYNCH)}$ Delay time, $\overline{\text{RESET}}$ low to asynchronous reset signals in the high-impedance state		21‡		21‡		21‡	ns
10	$t_{d(RESETH-COMMH)}$ Delay time, $\overline{\text{RESET}}$ high to asynchronous reset signals high		15‡		15‡		15‡	ns

$^\dagger t_{c(CI)}$, the CLKIN period as shown in Figure 7

‡ This value is characterized but not tested.



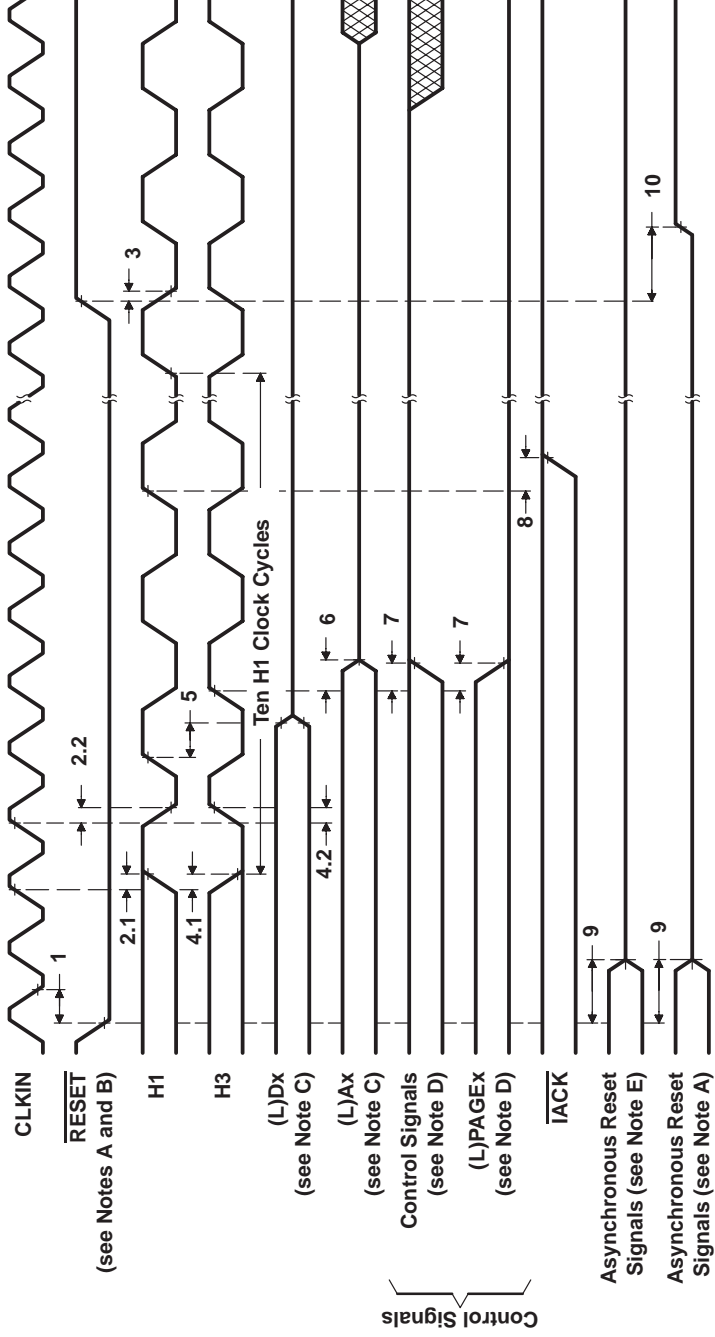

- NOTES:
- Asynchronous reset signals that go to a high logic level after $\overline{\text{RESET}}$ returns to a high state include $\overline{\text{CREQ}}$, $\overline{\text{CACKx}}$, $\overline{\text{CSTRBx}}$, and $\overline{\text{CRDYx}}$ ($x = 3, 4$ or 5).
 - $\overline{\text{RESET}}$ is an asynchronous input and can be asserted at any point during a clock cycle. If the specified timings are met, the exact sequence of an additional delay of one clock cycle can occur.
 - For Figure 19 only, (L)Dx includes D31–D0, LD31–LD0, and CxD7–CxD0, (L)Ax includes LA(30–0) and A(30–0).
 - Control signals LSTRB0, LSTRB1, STRB0, STRB1, (L)STAT3–(L)STAT0, (L)LOCK, (L)R/W0, and (L)RAW1 go high while (L)PAGE0 and (L)PAGE1 go low.
 - Asynchronous reset signals that go into the high-impedance state after $\overline{\text{RESET}}$ goes low include TCLK0, TCLK1, IIOF3–IIOF0, and the control signals $\overline{\text{CREQx}}$, $\overline{\text{CACKx}}$, $\overline{\text{CSTRBx}}$, and $\overline{\text{CRDYx}}$ (where $x = 0, 1$ or 2 , and $y = 3, 4$ or 5). At reset, ports 0, 1, and 2 become outputs, while ports 3, 4, and 5 become inputs.

Figure 19. RESET Timing

ADVANCE INFORMATION

TMS320C40 DIGITAL SIGNAL PROCESSOR

SPRS038 – JANUARY 1996

timing for $\overline{\text{IIOF}}_x$ interrupt response [$P = t_{c(H)}$] (see Notes 6, 7 and Figure 20)

NO.		TMS320C40-40 TMS320C40-50			TMS320C40-60			UNIT
		MIN	TYP	MAX	MIN	TYP	MAX	
1	$t_{su}(\overline{\text{IIOF}}_x)$ Setup time, $\overline{\text{IIOF}}_x$ before H1 low	1†			1†			ns
2	$t_w(\text{INT})$ Pulse duration, to assure one interrupt is seen (see Note 8)	P	1.5P	< 2P‡	P	1.5P	< 2P‡	ns

† If this timing is not met, the interrupt is recognized in the next cycle.

‡ This value applies only to level-triggered interrupts and is specified by design but not tested.

NOTES: 6. $\overline{\text{IIOF}}_x$ is an asynchronous input and can be asserted at any point during a clock cycle. If the specified timings are met, the exact sequence shown occurs; otherwise, an additional delay of one clock cycle can occur.

7. Edge-triggered interrupts require a setup of time (1) and a minimum duration of P. No maximum duration limit exists.

8. Level-triggered interrupts require interrupt-pulse duration of at least 1P wide (P = one H1 period) to assure it will be seen. It must be less than 2P wide to assure it will be responded to only once. Recommended pulse duration is 1.5P.

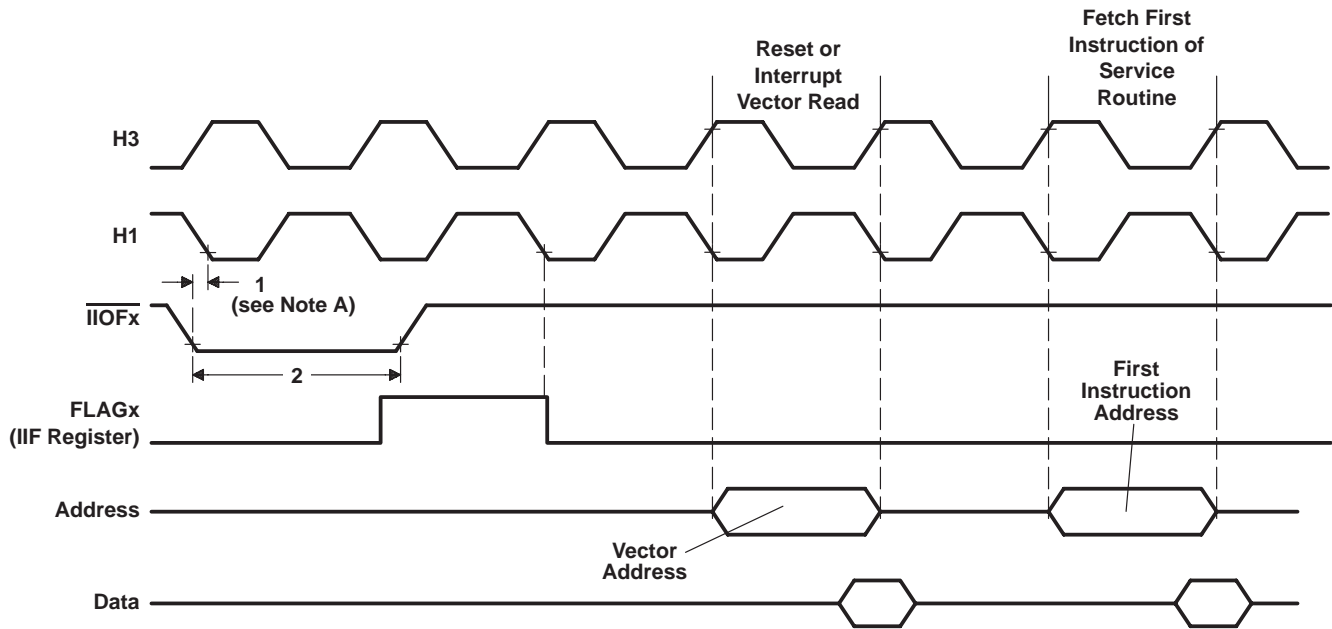

NOTE A: The 'C40 can accept an interrupt from the same source every two H1 clock cycles.

Figure 20. $\overline{\text{IIOF}}_x$ Interrupt-Response Timing [$P = t_{c(H)}$]

timing for $\overline{\text{IACK}}$ (see Note 9 and Figure 21)

NO.		TMS320C40-40 TMS320C40-50		TMS320C40-60		UNIT
		MIN	MAX	MIN	MAX	
1	$t_{d(H1L - \overline{\text{IACKL}})}$ Delay time, H1 low to $\overline{\text{IACK}}$ low		9		7	ns
2	$t_{d(H1L - \overline{\text{IACKH}})}$ Delay time, H1 low to $\overline{\text{IACK}}$ high during first cycle of IACK instruction data read		9		7	ns

NOTE 9: The $\overline{\text{IACK}}$ output is active for the entire duration of the bus cycle and is, therefore, extended if the bus cycle utilizes wait states.

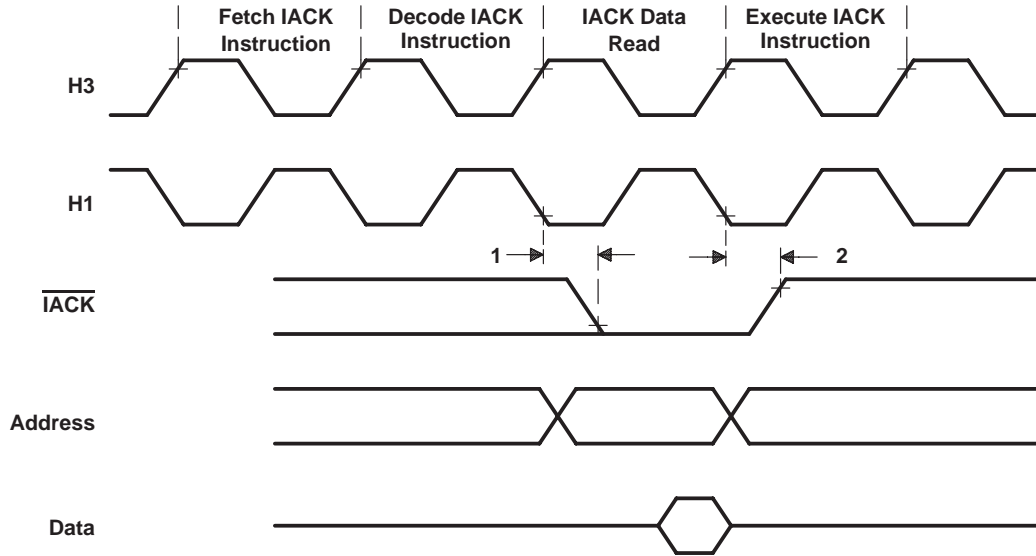

Figure 21. $\overline{\text{IACK}}$ Timing

TMS320C40 DIGITAL SIGNAL PROCESSOR

SPRS038 – JANUARY 1996

communication-port word-transfer-cycle timing† [P = t_{c(H)}] (see Note 10 and Figure 22)

NO.		TMS320C40-40 TMS320C40-50†		TMS320C40-60†		UNIT
		MIN	MAX	MIN	MAX	
1	t _{c(WORD)} ‡§ Cycle time, word transfer (4 bytes = 1 word)	1.5P+7	2.5P+170	1.5P+7	2.5P+170	ns
2	t _{d(CRDYL-CSL)W} ‡ Delay time, CRDYx low to CSTRBx low between back-to-back write cycles	1.5P+7	2.5P+28	1.5P+7	2.5P+28	ns

† For these timing values, it is assumed that the receiving 'C4x is ready to receive data. Line propagation delay is not considered.

‡ This value is characterized but not tested.

§ t_{c(WORD)} max = 2.5P + 28 ns + the maximum summed values of 4 × t_{d(CSL-CRDYL)R}, 3 × t_{d(CRDYL-CSH)}, 3 × t_{d(CSH-CRDYH)R}, and 3 × t_{d(CRDYH-CSL)W} as seen in Figure 23. This timing assumes two 'C4xs are connected.

NOTE 10: These timings apply only to two communicating 'C4xs. When a non-'C4x device communicates with a 'C40, timings can be longer. No restriction exists in this case on how slow the transfer could be except when using early silicon (C40 PG 1.x or 2.x). Refer to the CSTRB width restriction in Section 8.9.1 of the *TMS320C4x User's Guide* (literature number SPRU063B).

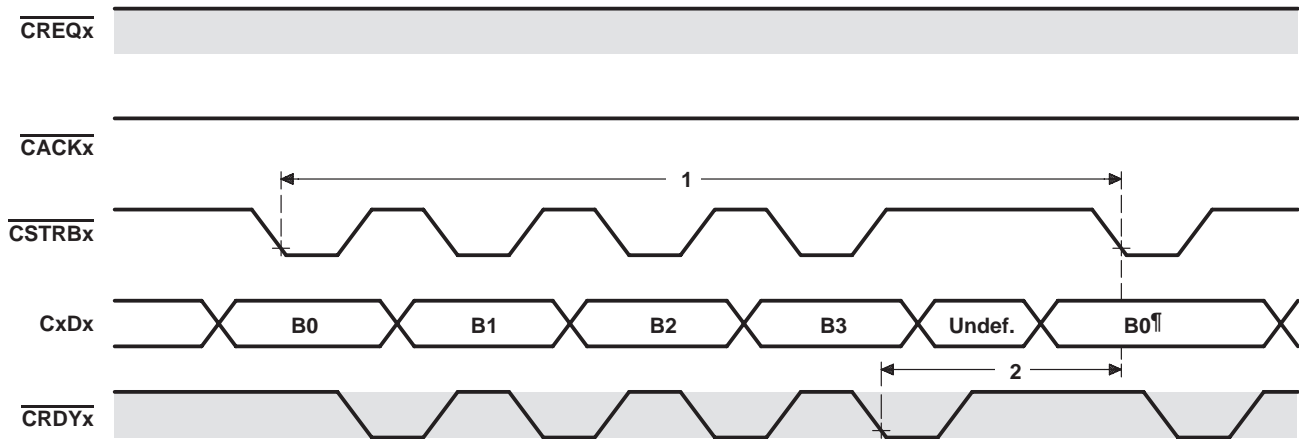

■ = When signal is an input (clear = when signal is an output).

† Begins byte 0 of the next word.

NOTE A: For correct operation during token exchange, the two communicating 'C4xs must have CLKIN frequencies within a factor of 2 of each other (in other words, at most, one of the 'C4xs can be twice as fast as the other).

Figure 22. Communication-Port Word-Transfer-Cycle Timing [P = t_{c(H)}]

communication-port byte-cycle timing (write and read) (see Note 11 and Figure 23)

NO.		TMS320C40-40 TMS320C40-50		TMS320C40-60		UNIT
		MIN	MAX	MIN	MAX	
1	$t_{su}(CD-CSL)W$ Setup time, CxDx valid before \overline{CSTRBx} low (write)	2		2		ns
2	$t_d(CRDYL-CSH)W$ Delay time, \overline{CRDYx} low to \overline{CSTRBx} high (write)	0†	12	0†	12	ns
3	$t_h(CRDYL-CD)W$ Hold time, CxDx after \overline{CRDYx} low (write)	2		2		ns
4	$t_d(CRDYH-CSL)W$ Delay time, \overline{CRDYx} high to \overline{CSTRBx} low for subsequent bytes (write)	0†	12	0†	12	ns
5	$t_c(BYTE)‡$ Cycle time, byte transfer		44§		44§	ns
6	$t_d(CSL-CRDYL)R$ Delay time, \overline{CSTRBx} low to \overline{CRDYx} low (read)	0†	10	0†	10	ns
7	$t_{su}(CSH-CD)R$ Setup time, CxDx valid after \overline{CSTRBx} high (read)	0		0		ns
8	$t_h(CRDYL-CD)R$ Hold time, CxDx valid after \overline{CRDYx} low (read)	2		2		ns
9	$t_d(CSH-CRDYH)R$ Delay time, \overline{CSTRBx} high to \overline{CRDYx} high (read)	0†	10	0†	10	ns

† This value is specified by design but not tested.

‡ $t_c(BYTE)$ max = summed maximum values of $t_d(CRDY-CSH)$, $t_d(CSL-CRDYL)R$, $t_d(CSH-CRDYH)R$, and $t_d(CRDYH-CSL)W$. This assumes two 'C4xs are connected.

§ This value is characterized but not tested.

NOTE 11: Communication port timing does not include line length delay.

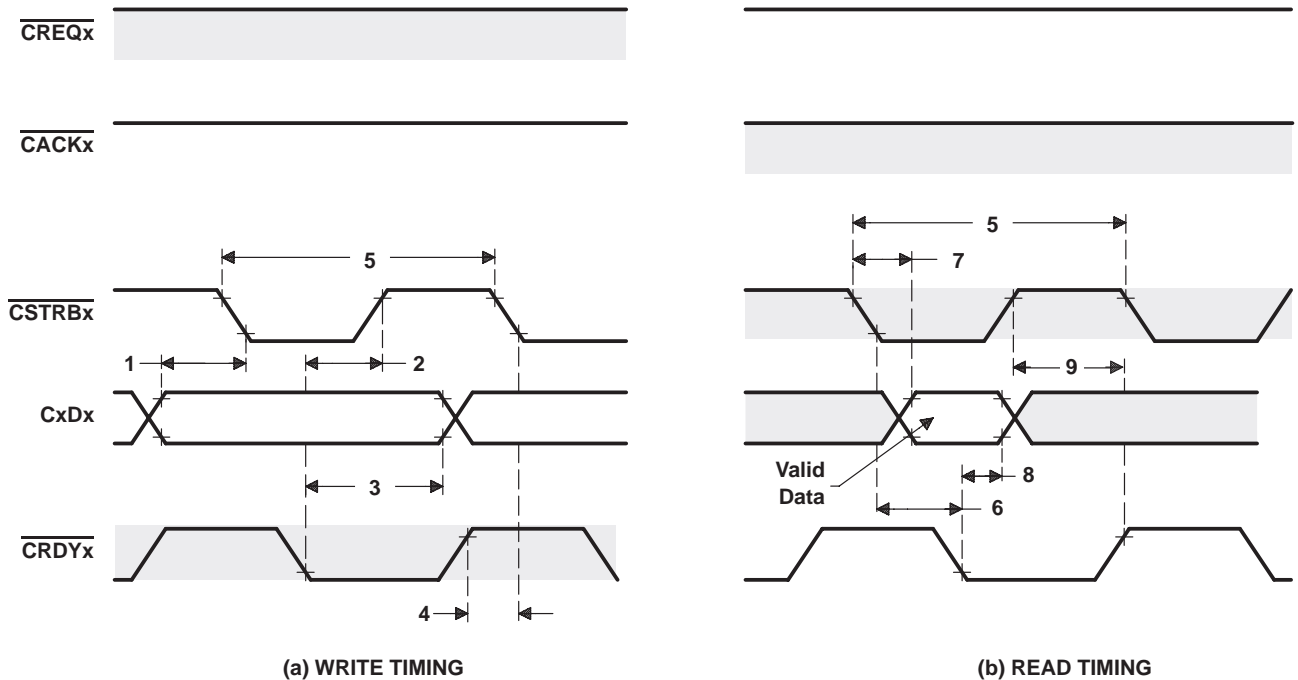

= When signal is an input (clear = when signal is an output).

Figure 23. Communication-Port Byte-Cycle Timing (Write and Read)

TMS320C40 DIGITAL SIGNAL PROCESSOR

SPRS038 – JANUARY 1996

timing for communication-token transfer sequence, input to an output port [$P = t_c(H)$]
(see Figure 24)[†]

NO.			TMS320C40-40 TMS320C40-50		TMS320C40-60		UNIT
			MIN	MAX	MIN	MAX	
1 [‡]	$t_d(CAL-CS)T$	Delay time, \overline{CACKx} low to \overline{CSTRBx} change from input to a high-level output	0.5P+6	1.5P+22	0.5P+6	1.5P+22	ns
2 [‡]	$t_d(CAL-CRQH)T$	Delay time, \overline{CACKx} low to start of \overline{CREQx} going high for token request acknowledge	P+5	2P+22	P+5	2P+22	ns
3	$t_d(CRQH-CRQ)T$	Delay time, start of \overline{CREQx} going high to \overline{CREQx} change from output to an input	0.5P-5	0.5P+13	0.5P-5	0.5P+13	ns
4	$t_d(CRQH-CA)T$	Delay time, start of \overline{CREQx} going high to \overline{CACKx} change from an input to an output level high	0.5P-5	0.5P+13	0.5P-5	0.5P+13	ns
4.1	$t_d(CRQH-CD)T$	Delay time, start of \overline{CREQx} going high to CxDx change from inputs driven to outputs driven	0.5P-5	0.5P+13	0.5P-5	0.5P+13	ns
4.2	$t_d(CRQH-CRDY)T$	Delay time, start of \overline{CREQx} going high to \overline{CRDYx} change from an output to an input	0.5P-5	0.5P+13	0.5P-5	0.5P+13	ns
5	$t_d(CRQH-CSL)T$	Delay time, start of \overline{CREQx} going high to \overline{CSTRBx} low for start of word transfer out	1.5P-8	1.5P+9	1.5P-8	1.5P+9	ns
6 [‡]	$t_d(CRDYL-CSL)T$	Delay time, \overline{CRDYx} low at end of word input to \overline{CSTRBx} low for word output	3.5P+12	5.5P+48	3.5P+12	5.5P+48	ns

[†] These values are characterized but not tested.

[‡] These timing parameters result from synchronizer delays.



timing for communication-token transfer sequence, input to an output port [$P = t_{c(H)}$] (continued)

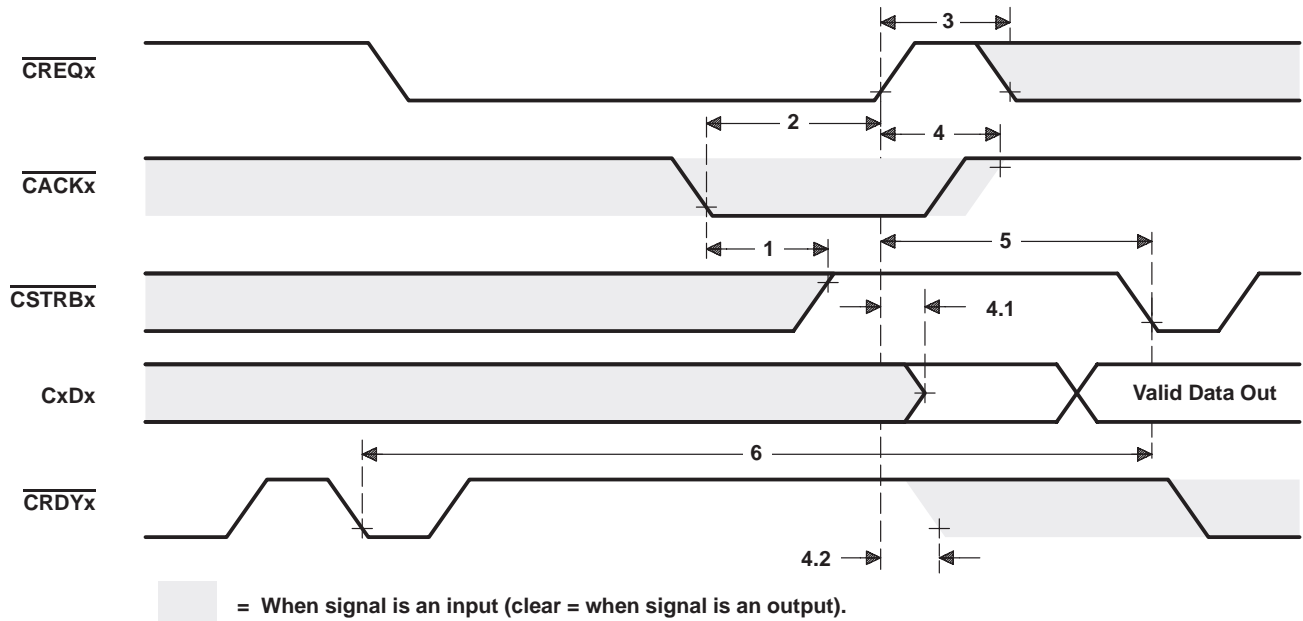

NOTE A: Before the token exchange, \overline{CREQx} and \overline{CRDYx} are output signals asserted by the TMS320C4x that is receiving data. \overline{CACKx} , \overline{CSTRBx} , and $CxD7-CxD0$ are input signals asserted by the device sending data to the 'C4x; these are asynchronous with respect to the H1 clock of the receiving '320C4x. After token exchange, \overline{CACKx} , \overline{CSTRBx} , and $CxD7-CxD0$ become output signals, and \overline{CREQx} and \overline{CRDYx} become inputs.

Figure 24. Communication-Token Transfer Sequence, Input to an Output Port [$P = t_{c(H)}$]

TMS320C40 DIGITAL SIGNAL PROCESSOR

SPRS038 – JANUARY 1996

timing for communication-token transfer sequence, output to an input port [$P = t_c(H)$]
(see Figure 25)[†]

NO.			TMS320C40-40 TMS320C40-50		TMS320C40-60		UNIT
			MIN	MAX	MIN	MAX	
1 [‡]	$t_d(\overline{CRQL} - \overline{CAL})T$	Delay time, \overline{CREQx} low to start of \overline{CACKx} going low for token-request-acknowledge	P+5	2P+22	P+5	2P+22	ns
2 [‡]	$t_d(\overline{CRDYL} - \overline{CAL})T$	Delay time, \overline{CRDYx} low at end of word transfer out to start of \overline{CACKx} going low	P+6	2P+27	P+6	2P+27	ns
3	$t_d(\overline{CAL} - \overline{CD})I$	Delay time, start of \overline{CACKx} going low to CxDx change from outputs to inputs	0.5P-8	0.5P+8	0.5P-8	0.5P+8	ns
4	$t_d(\overline{CAL} - \overline{CRDY})T$	Delay time, start of \overline{CACKx} going low to \overline{CRDYx} change from an input to output, high level	0.5P-8	0.5P+8	0.5P-8	0.5P+8	ns
5	$t_d(\overline{CRQH} - \overline{CRQ})T$	Delay time, \overline{CREQx} high to \overline{CREQx} change from an input to output, high level	4	22	4	22	ns
6	$t_d(\overline{CRQH} - \overline{CA})T$	Delay time, \overline{CREQx} high to \overline{CACKx} change from output to an input	4	22	4	22	ns
7	$t_d(\overline{CRQH} - \overline{CS})T$	Delay time, \overline{CREQx} high to \overline{CSTRBx} change from output to an input	4	22	4	22	ns
8 [‡]	$t_d(\overline{CRQH} - \overline{CRQL})T$	Delay time, \overline{CREQx} high to \overline{CREQx} low for the next token request	P-4	2P+8	P-4	2P+8	ns

[†] These values are characterized but not tested.

[‡] These timing parameters result from synchronizer delays.



timing for communication-token transfer sequence, input to an output port [$P = t_{c(H)}$] (continued)

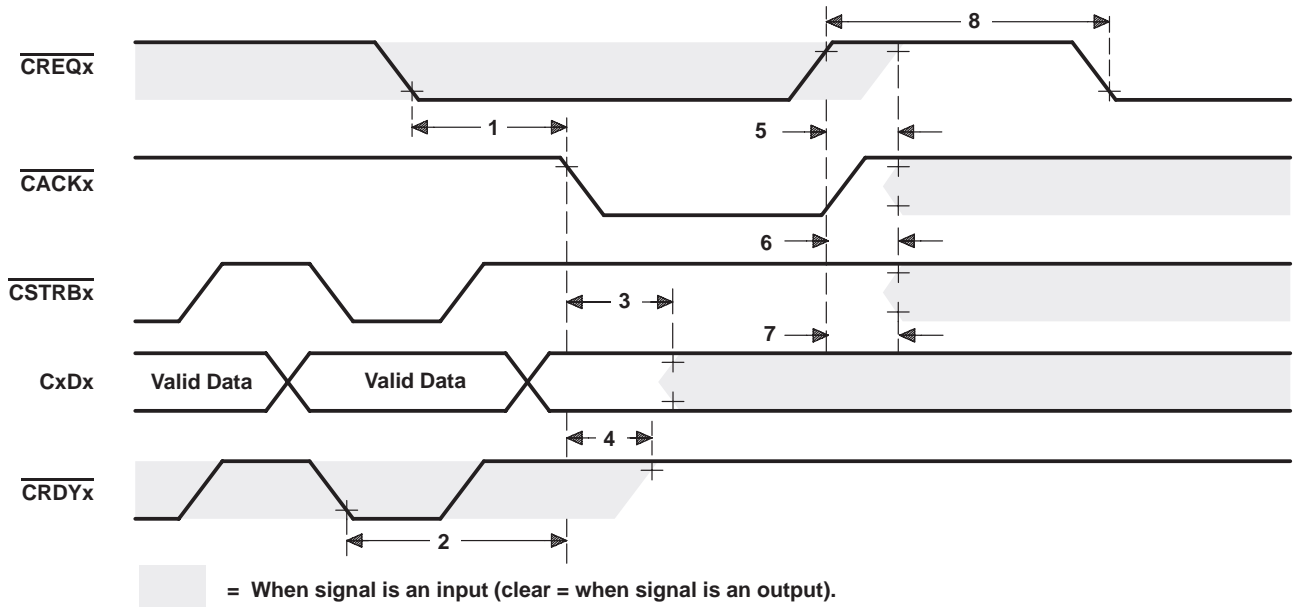

NOTE A: Before the token exchange, \overline{CACKx} , \overline{CSTRBx} , and $CxD7-CxD0$ are asserted by the 'C4x sending data. \overline{CREQx} and \overline{CRDYx} are input signals asserted by the 'C4x receiving data and are asynchronous with respect to the H1 clock of the sending 'C4x. After token exchange, \overline{CREQx} and \overline{CRDYx} become outputs, and \overline{CSTRBx} , \overline{CACKx} , and $CxDx$ become inputs.

Figure 25. Communication-Token Transfer Sequence, Output to an Input Port [$P = t_{c(H)}$]

TMS320C40 DIGITAL SIGNAL PROCESSOR

SPRS038 – JANUARY 1996

timer pin timing (see Note 12 and Figure 26)

NO.		TMS320C40-40 TMS320C40-50		TMS320C40-60		UNIT
		MIN	MAX	MIN	MAX	
1	$t_{su}(TCLK-H1L)$ Setup time, TCLKx before H1 low	10		10		ns
2	$t_h(H1L-TCLK)$ Hold time, TCLKx after H1 low	0		0		ns
3	$t_d(H1H-TCLK)$ Delay time, TCLKx valid after H1 high		13		13	ns

NOTE 12: Period and polarity of valid logic level are specified by contents of internal control registers.

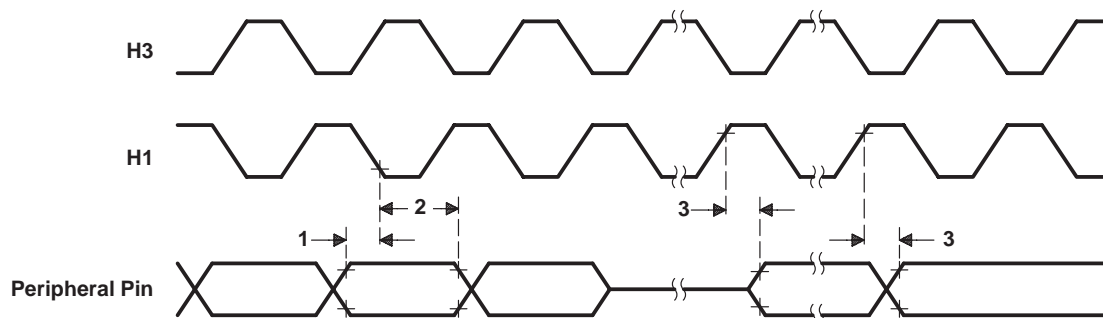

Figure 26. Timer Pin Timing Cycle

timing for IEEE-1149.1 test access port (see Figure 27)

NO.		TMS320C40-40 TMS320C40-50		TMS320C40-60		UNIT
		MIN	MAX	MIN	MAX	
1	$t_{su}(TMS-TCKH)$ Setup time, TMS/TDI to TCK high	10		10		ns
2	$t_h(TCKH-TMS)$ Hold time, TMS/TDI from TCK high	5		5		ns
3	$t_d(TCKL-TDOV)$ Delay time, TCK low to TDO valid	0	15	0	12	ns

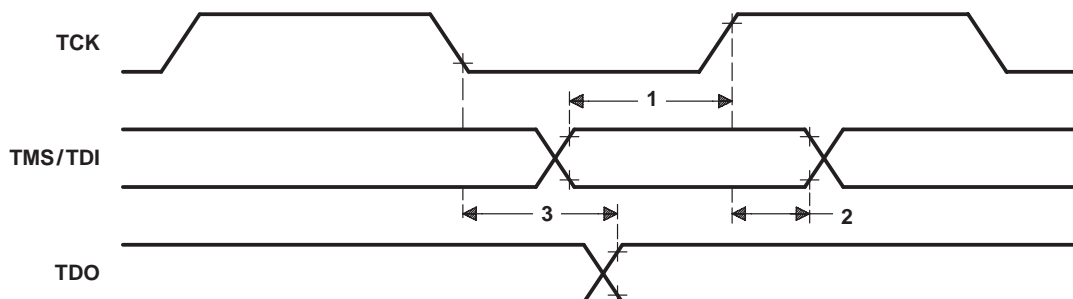

Figure 27. IEEE-1149.1 Test Access Port Timings



PACKAGING INFORMATION

Orderable Device	Status ⁽¹⁾	Package Type	Package Drawing	Pins	Package Qty	Eco Plan ⁽²⁾	Lead/ Ball Finish	MSL Peak Temp ⁽³⁾	Samples (Requires Login)
TMS320C40GFL40	NRND	CPGA	GF	325	10	TBD	AU	N / A for Pkg Type	
TMS320C40GFL50	NRND	CPGA	GF	325	10	TBD	AU	N / A for Pkg Type	
TMS320C40GFL60	NRND	CPGA	GF	325	1	TBD	AU	N / A for Pkg Type	

⁽¹⁾ The marketing status values are defined as follows:

ACTIVE: Product device recommended for new designs.

LIFEBUY: TI has announced that the device will be discontinued, and a lifetime-buy period is in effect.

NRND: Not recommended for new designs. Device is in production to support existing customers, but TI does not recommend using this part in a new design.

PREVIEW: Device has been announced but is not in production. Samples may or may not be available.

OBSELETE: TI has discontinued the production of the device.

⁽²⁾ Eco Plan - The planned eco-friendly classification: Pb-Free (RoHS), Pb-Free (RoHS Exempt), or Green (RoHS & no Sb/Br) - please check <http://www.ti.com/productcontent> for the latest availability information and additional product content details.

TBD: The Pb-Free/Green conversion plan has not been defined.

Pb-Free (RoHS): TI's terms "Lead-Free" or "Pb-Free" mean semiconductor products that are compatible with the current RoHS requirements for all 6 substances, including the requirement that lead not exceed 0.1% by weight in homogeneous materials. Where designed to be soldered at high temperatures, TI Pb-Free products are suitable for use in specified lead-free processes.

Pb-Free (RoHS Exempt): This component has a RoHS exemption for either 1) lead-based flip-chip solder bumps used between the die and package, or 2) lead-based die adhesive used between the die and leadframe. The component is otherwise considered Pb-Free (RoHS compatible) as defined above.

Green (RoHS & no Sb/Br): TI defines "Green" to mean Pb-Free (RoHS compatible), and free of Bromine (Br) and Antimony (Sb) based flame retardants (Br or Sb do not exceed 0.1% by weight in homogeneous material)

⁽³⁾ MSL, Peak Temp. -- The Moisture Sensitivity Level rating according to the JEDEC industry standard classifications, and peak solder temperature.

Important Information and Disclaimer: The information provided on this page represents TI's knowledge and belief as of the date that it is provided. TI bases its knowledge and belief on information provided by third parties, and makes no representation or warranty as to the accuracy of such information. Efforts are underway to better integrate information from third parties. TI has taken and continues to take reasonable steps to provide representative and accurate information but may not have conducted destructive testing or chemical analysis on incoming materials and chemicals. TI and TI suppliers consider certain information to be proprietary, and thus CAS numbers and other limited information may not be available for release.

In no event shall TI's liability arising out of such information exceed the total purchase price of the TI part(s) at issue in this document sold by TI to Customer on an annual basis.

OTHER QUALIFIED VERSIONS OF TMS320C40 :

● Catalog: [SM320C40](#)

● Military: [SMJ320C40](#)

NOTE: Qualified Version Definitions:

- Catalog - TI's standard catalog product
- Military - QML certified for Military and Defense Applications

GF (S-CPGA-P325)

CERAMIC PIN GRID ARRAY

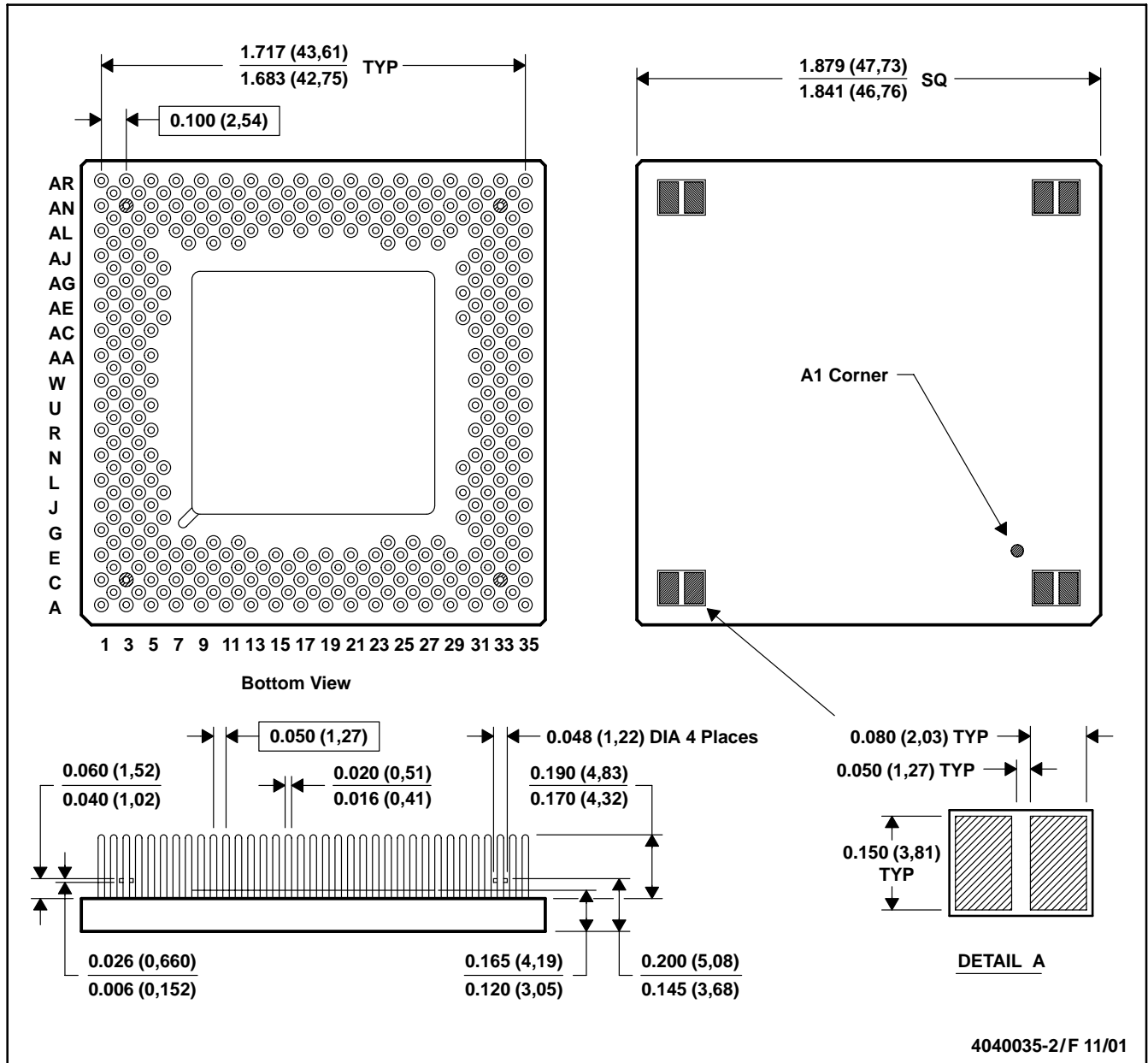

- NOTES:
- A. All linear dimensions are in inches (millimeters).
 - B. This drawing is subject to change without notice.
 - C. Index mark can appear on top or bottom, depending on package vendor.
 - D. Pins are located within 0.010 (0,25) diameter of true position relative to each other at maximum material condition and within 0.030 (0,76) diameter relative to the edge of the ceramic.
 - E. This package can be hermetically sealed with metal lids or with ceramic lids using glass frit.
 - F. The pins can be gold-plated or solder-dipped.
 - G. Package thickness of 0.165 (4,19) / 0.120 (3,05) includes package body and lid.
 - H. Falls within JEDEC MO-128AK

IMPORTANT NOTICE

Texas Instruments Incorporated and its subsidiaries (TI) reserve the right to make corrections, modifications, enhancements, improvements, and other changes to its products and services at any time and to discontinue any product or service without notice. Customers should obtain the latest relevant information before placing orders and should verify that such information is current and complete. All products are sold subject to TI's terms and conditions of sale supplied at the time of order acknowledgment.

TI warrants performance of its hardware products to the specifications applicable at the time of sale in accordance with TI's standard warranty. Testing and other quality control techniques are used to the extent TI deems necessary to support this warranty. Except where mandated by government requirements, testing of all parameters of each product is not necessarily performed.

TI assumes no liability for applications assistance or customer product design. Customers are responsible for their products and applications using TI components. To minimize the risks associated with customer products and applications, customers should provide adequate design and operating safeguards.

TI does not warrant or represent that any license, either express or implied, is granted under any TI patent right, copyright, mask work right, or other TI intellectual property right relating to any combination, machine, or process in which TI products or services are used. Information published by TI regarding third-party products or services does not constitute a license from TI to use such products or services or a warranty or endorsement thereof. Use of such information may require a license from a third party under the patents or other intellectual property of the third party, or a license from TI under the patents or other intellectual property of TI.

Reproduction of TI information in TI data books or data sheets is permissible only if reproduction is without alteration and is accompanied by all associated warranties, conditions, limitations, and notices. Reproduction of this information with alteration is an unfair and deceptive business practice. TI is not responsible or liable for such altered documentation. Information of third parties may be subject to additional restrictions.

Resale of TI products or services with statements different from or beyond the parameters stated by TI for that product or service voids all express and any implied warranties for the associated TI product or service and is an unfair and deceptive business practice. TI is not responsible or liable for any such statements.

TI products are not authorized for use in safety-critical applications (such as life support) where a failure of the TI product would reasonably be expected to cause severe personal injury or death, unless officers of the parties have executed an agreement specifically governing such use. Buyers represent that they have all necessary expertise in the safety and regulatory ramifications of their applications, and acknowledge and agree that they are solely responsible for all legal, regulatory and safety-related requirements concerning their products and any use of TI products in such safety-critical applications, notwithstanding any applications-related information or support that may be provided by TI. Further, Buyers must fully indemnify TI and its representatives against any damages arising out of the use of TI products in such safety-critical applications.

TI products are neither designed nor intended for use in military/aerospace applications or environments unless the TI products are specifically designated by TI as military-grade or "enhanced plastic." Only products designated by TI as military-grade meet military specifications. Buyers acknowledge and agree that any such use of TI products which TI has not designated as military-grade is solely at the Buyer's risk, and that they are solely responsible for compliance with all legal and regulatory requirements in connection with such use.

TI products are neither designed nor intended for use in automotive applications or environments unless the specific TI products are designated by TI as compliant with ISO/TS 16949 requirements. Buyers acknowledge and agree that, if they use any non-designated products in automotive applications, TI will not be responsible for any failure to meet such requirements.

Following are URLs where you can obtain information on other Texas Instruments products and application solutions:

Products

Audio	www.ti.com/audio
Amplifiers	amplifier.ti.com
Data Converters	dataconverter.ti.com
DLP® Products	www.dlp.com
DSP	dsp.ti.com
Clocks and Timers	www.ti.com/clocks
Interface	interface.ti.com
Logic	logic.ti.com
Power Mgmt	power.ti.com
Microcontrollers	microcontroller.ti.com
RFID	www.ti-rfid.com
OMAP Mobile Processors	www.ti.com/omap
Wireless Connectivity	www.ti.com/wirelessconnectivity

Applications

Automotive and Transportation	www.ti.com/automotive
Communications and Telecom	www.ti.com/communications
Computers and Peripherals	www.ti.com/computers
Consumer Electronics	www.ti.com/consumer-apps
Energy and Lighting	www.ti.com/energy
Industrial	www.ti.com/industrial
Medical	www.ti.com/medical
Security	www.ti.com/security
Space, Avionics and Defense	www.ti.com/space-avionics-defense
Video and Imaging	www.ti.com/video

TI E2E Community Home Page

e2e.ti.com

Mailing Address: Texas Instruments, Post Office Box 655303, Dallas, Texas 75265
Copyright © 2012, Texas Instruments Incorporated

Looking for pricing, stock, or lifecycle information?

Click below to explore more details on WIN SOURCE:

 [View TMS320C40GFL40 on WIN SOURCE](#)

 [Texas Instruments](#) Information

Optimize Your Supply Chain with WIN SOURCE Solutions

-  Global Sourcing Solution
-  Obsolete Management
-  Cost Control Management
-  Shortage Management
-  Alternative Solution
-  Excess Inventory Management