

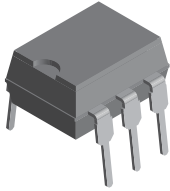


**THE DATASHEET OF
ILD66-4**

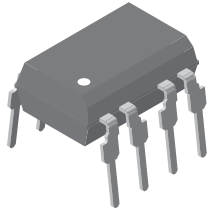


Optocoupler, Photodarlington Output, with Internal RBE (Single, Dual, Quad Channel)

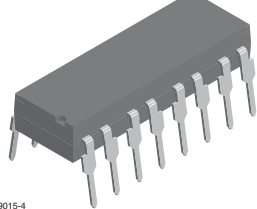
Single Channel



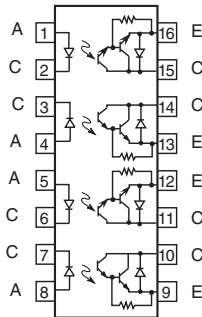
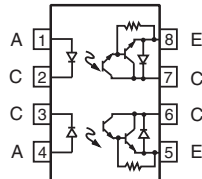
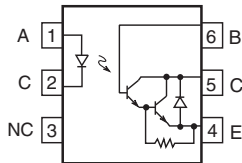
Dual Channel



Quad Channel



1179015-4



FEATURES

- Internal RBE for high stability
- Four available CTR categories per package type
- $BV_{CEO} > 60\text{ V}$
- Standard DIP packages
- Compliant to RoHS Directive 2002/95/EC and in accordance with WEEE 2002/96/EC



RoHS COMPLIANT

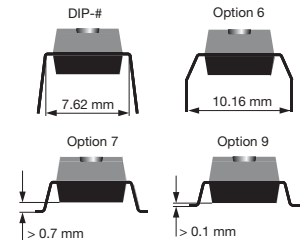
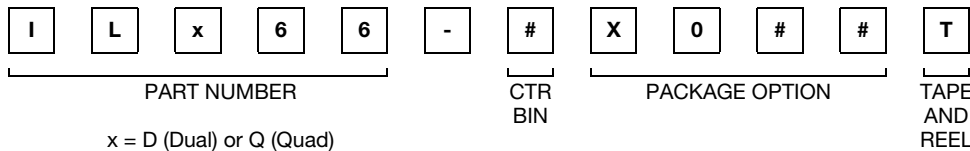
DESCRIPTION

IL66, ILD66, and ILQ66 are optically coupled isolators employing gallium arsenide infrared emitters and silicon photodarlington detectors. Switching can be accomplished while maintaining a high degree of isolation between driving and load circuits, with no crosstalk between channels.

AGENCY APPROVALS

- UL1577, file no. E52744 system code H, double protection
- cUL tested to CSA 22.2 bulletin 5A
- DIN EN 60747-5-2 (VDE 0884)/DIN EN 60747-5-5 pending available with option 1
- BSI IEC 60950; IEC 60065

ORDERING INFORMATION



AGENCY CERTIFIED/PACKAGE	SINGLE CHANNEL		DUAL CHANNEL		QUAD CHANNEL			
	CTR (%)							
	2 mA				0.7 mA		2 mA	
UL, cUL, BSI	≥ 100	≥ 300	≥ 300	≥ 500	≥ 100	≥ 300	≥ 400	≥ 500
DIP-4	IL66-1	IL66-2	-	-	-	-	-	-
DIP-8	-	-	ILD66-2	ILD66-4	-	-	-	-
SMD-8, option 7	-	-	-	ILD66-4X007T	-	-	-	-
SMD-8, option 9	-	-	-	ILD66-4X009	-	-	-	-
DIP-16	-	-	-	-	ILQ66-1	ILQ66-2	ILQ66-3	ILQ66-4
SMD-16, option 7	-	-	-	-	-	-	-	ILQ66-4X007T
SMD-16, option 9	-	-	-	-	-	-	-	ILQ66-4X009T
VDE, UL, cUL, BSI	≥ 100	≥ 300	≥ 300	≥ 500	≥ 100	≥ 300	≥ 400	≥ 500
DIP-4, 400 mil, option 6	IL66-1X016							
DIP-16								ILQ66-4X001

Note

- Additional option may be possible, please contact sales office.



ABSOLUTE MAXIMUM RATINGS ($T_{amb} = 25\text{ }^{\circ}\text{C}$, unless otherwise specified)					
PARAMETER	TEST CONDITION	PART	SYMBOL	VALUE	UNIT
INPUT					
Peak reverse voltage			V_{RM}	6.0	V
Forward continuous current			I_F	60	mA
Power dissipation			P_{diss}	100	mW
Derate linearly from 25 °C				1.33	mW/°C
OUTPUT					
Power dissipation			P_{diss}	150	mW
Derate from 25 °C				2.0	mW/°C
COUPLER					
Isolation test voltage	$t = 1.0\text{ s}$		V_{ISO}	5300	V_{RMS}
Total package power dissipation		IL66	P_{tot}	250	mW
		ILD66	P_{tot}	400	mW
		ILQ66	P_{tot}	500	mW
Derate linearly from 25 °C		IL66		3.3	mW/°C
		ILD66		5.33	mW/°C
		ILQ66		6.67	mW/°C
Creepage distance				≥ 7.0	mm
Clearance distance				≥ 7.0	mm
Comparative tracking index			CTI	175	
Isolation resistance	$V_{IO} = 500\text{ V}, T_{amb} = 25\text{ }^{\circ}\text{C}$		R_{IO}	$\geq 10^{12}$	Ω
	$V_{IO} = 500\text{ V}, T_{amb} = 100\text{ }^{\circ}\text{C}$		R_{IO}	$\geq 10^{11}$	Ω
Storage temperature			T_{stg}	- 55 to + 125	°C
Operating temperature			T_{amb}	- 55 to + 100	°C
Lead soldering time at 260 °C				10	s

Note

- Stresses in excess of the absolute maximum ratings can cause permanent damage to the device. Functional operation of the device is not implied at these or any other conditions in excess of those given in the operational sections of this document. Exposure to absolute maximum ratings for extended periods of the time can adversely affect reliability.

ELECTRICAL CHARACTERISTICS ($T_{amb} = 25\text{ }^{\circ}\text{C}$, unless otherwise specified)						
PARAMETER	TEST CONDITION	SYMBOL	MIN.	TYP.	MAX.	UNIT
INPUT						
Forward voltage	$I_F = 20\text{ mA}$	V_F		1.25	1.5	V
Reverse current	$V_R = 6.0\text{ V}$	I_R		0.1	10	μA
Capacitance	$V_R = 0\text{ V}$	C_O		25		pF
OUTPUT						
Collector emitter breakdown voltage	$I_C = 1.0\text{ mA}, I_F = 0\text{ A}$	BV_{CEO}	60			V
Collector base breakdown voltage (IL66)	$I_C = 10\text{ }\mu\text{A}$	BV_{CBO}	60			V
Collector emitter leakage current	$V_{CE} = 50\text{ V}, I_F = 0\text{ A}$	I_{CEO}		1.0	100	nA
Capacitance collector emitter	$V_{CE} = 10\text{ V}$			3.4		pF
COUPLER						
Saturation voltage, collector emitter	$I_C = 10\text{ mA}, I_F = 10\text{ mA}$	V_{CEsat}		0.9	1.0	V

Note

- Minimum and maximum values are testing requirements. Typical values are characteristics of the device and are the result of engineering evaluation. Typical values are for information only and are not part of the testing requirements.

CURRENT TRANSFER RATIO ($T_{amb} = 25\text{ }^{\circ}\text{C}$, unless otherwise specified)							
PARAMETER	TEST CONDITION	PART	SYMBOL	MIN.	TYP.	MAX.	UNIT
Current transfer ratio	$I_F = 2.0\text{ mA}$, $V_{CE} = 10\text{ V}$	IL(D,Q)66-1	CTR	100	400		%
		IL(D,Q)66-2	CTR	300	500		%
	$I_F = 0.7\text{ mA}$, $V_{CE} = 10\text{ V}$	IL(D,Q)66-3	CTR	400	500		%
	$I_F = 2.0\text{ mA}$, $V_{CE} = 5.0\text{ V}$	IL(D,Q)66-4	CTR	500	750		%

SWITCHING CHARACTERISTICS ($T_{amb} = 25\text{ }^{\circ}\text{C}$, unless otherwise specified)							
PARAMETER	TEST CONDITION	SYMBOL	MIN.	TYP.	MAX.	UNIT	
NON SATURATED							
Rise time -1, -2, -4	$V_{CC} = 10\text{ V}$, $I_F = 2.0\text{ mA}$, $R_L = 100\text{ }\Omega$	t_r			200	μs	
Fall time -1, -2, -4	$V_{CC} = 10\text{ V}$, $I_F = 2.0\text{ mA}$, $R_L = 100\text{ }\Omega$	t_f			200	μs	
Rise time -3	$V_{CC} = 10\text{ V}$, $I_F = 0.7\text{ mA}$, $R_L = 100\text{ }\Omega$	t_r			200	μs	
Fall time -3	$V_{CC} = 10\text{ V}$, $I_F = 0.7\text{ mA}$, $R_L = 100\text{ }\Omega$	t_f			200	μs	

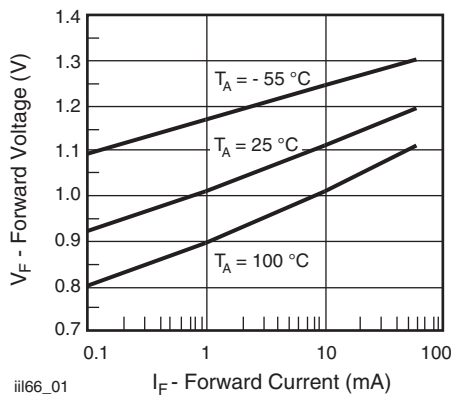
TYPICAL CHARACTERISTICS ($T_{amb} = 25\text{ }^{\circ}\text{C}$, unless otherwise specified)


Fig. 1 - Forward Voltage vs. Forward Current

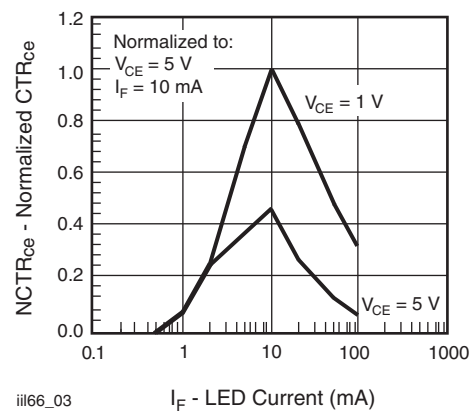
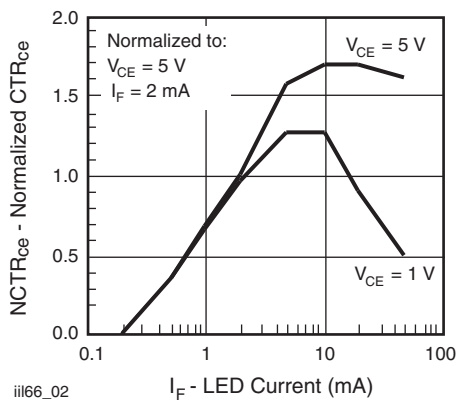
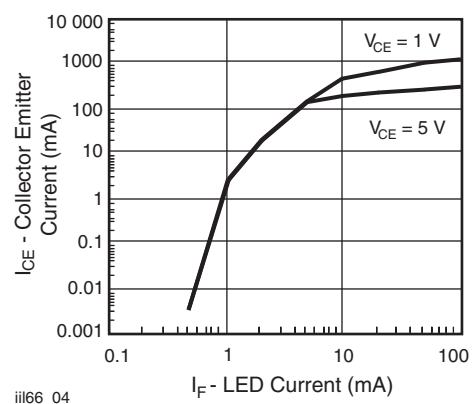

 Fig. 3 - Normalized Non-Saturated and Saturated CTR_{ce} vs. LED Current

 Fig. 2 - Normalized Non-Saturated and Saturated CTR_{ce} vs. LED Current


Fig. 4 - Non-Saturated and Saturated Collector Emitter Current vs. LED Current

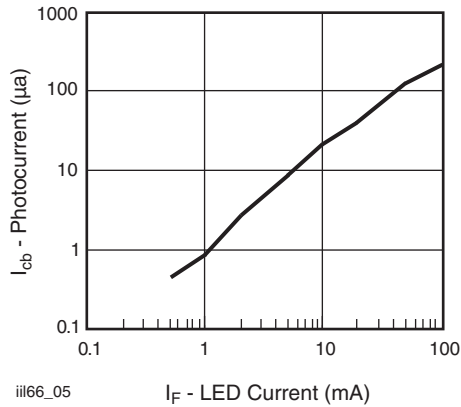


Fig. 5 - Collector Base Photocurrent vs. LED Current

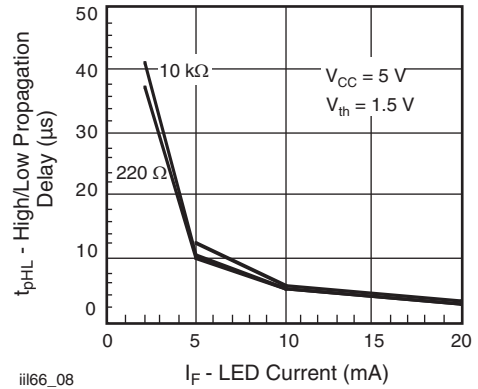


Fig. 8 - High to Low Propagation Delay vs. Collector Load Resistance and LED Current

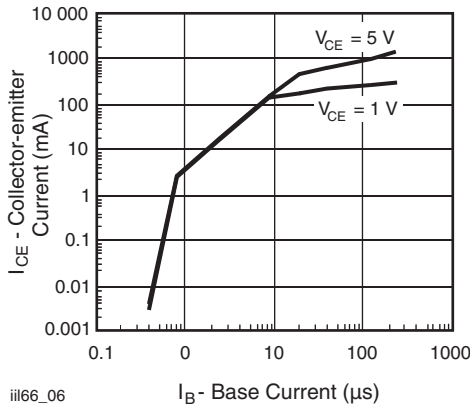


Fig. 6 - Collector Emitter Current vs. LED Current

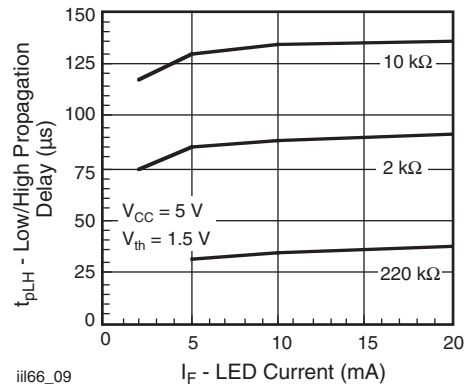


Fig. 9 - Low to High Propagation Delay vs. Collector Load Resistance and LED Current

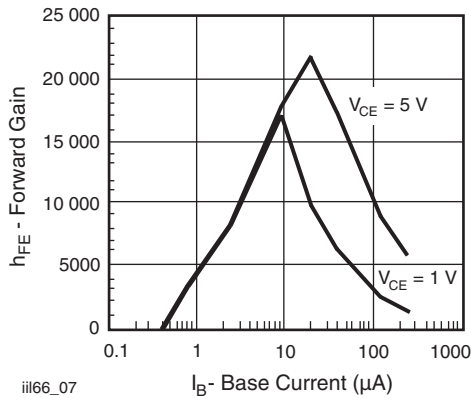


Fig. 7 - Non-Saturated and Saturated h_{FE} vs. LED Current

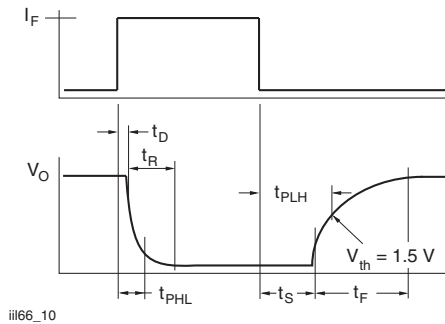


Fig. 10 - Switching Waveform

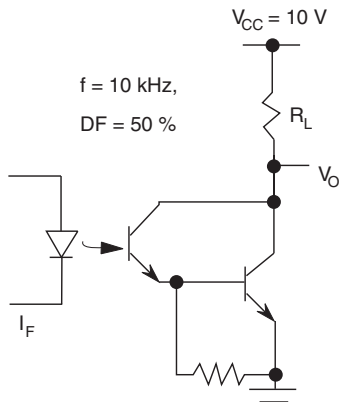
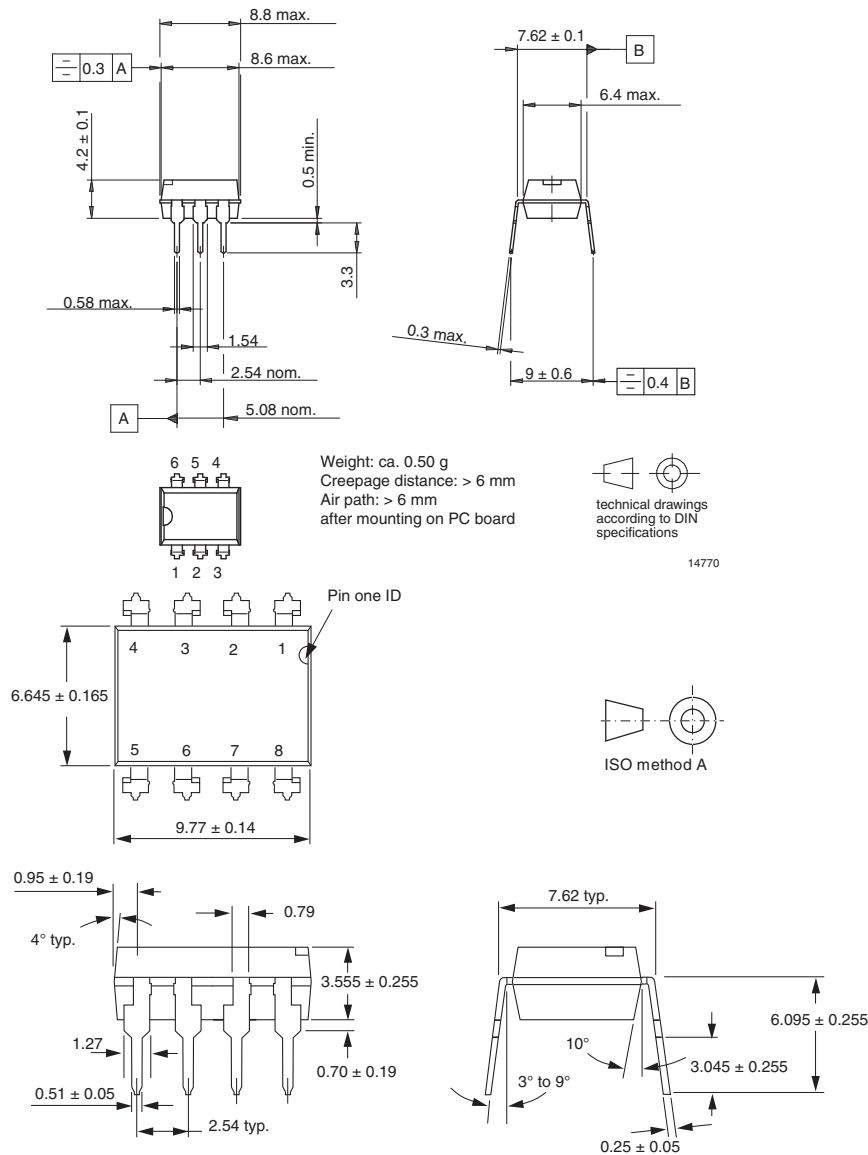
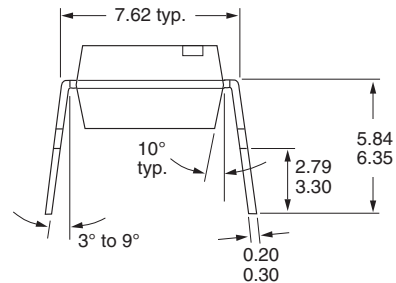
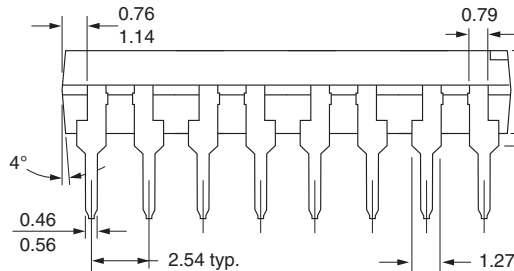
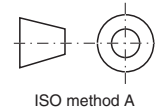
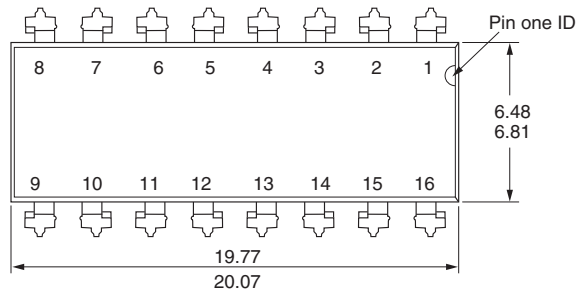


Fig. 11 - Switching Schematic

PACKAGE DIMENSIONS in millimeters

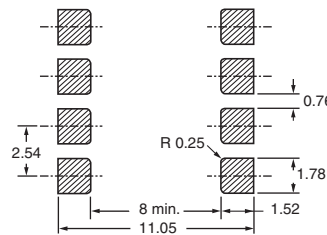
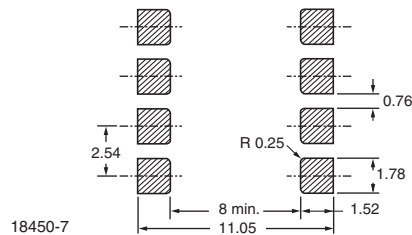
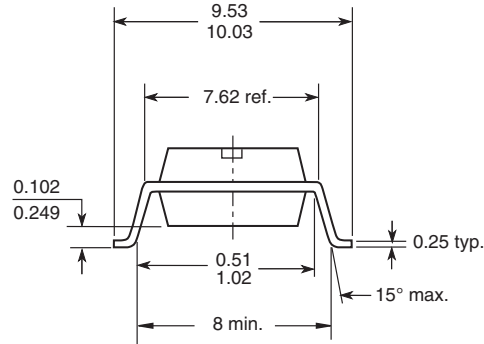
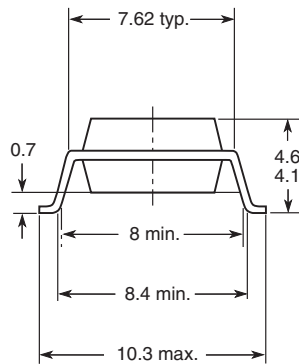




i178007

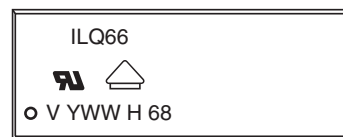
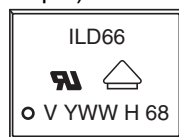
Option 7

Option 9



18450-7

PACKAGE MARKING (example)

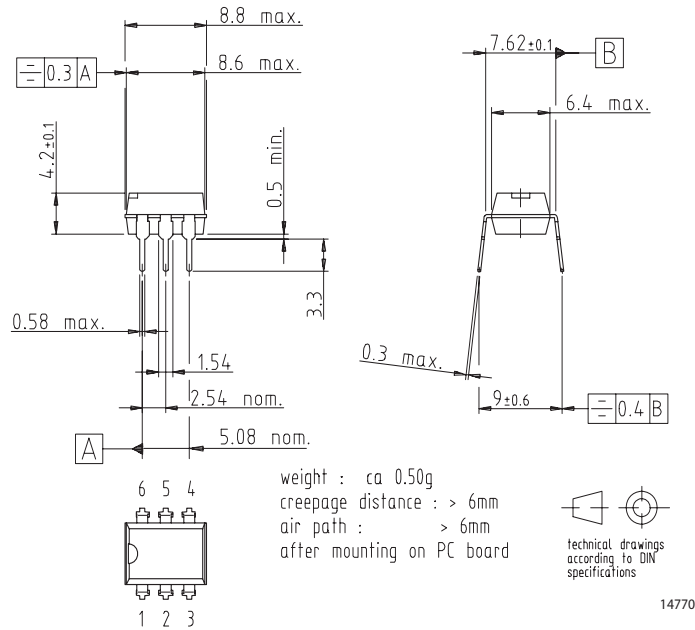


Notes

- Only options 1 and 7 reflected in the package marking
- The VDE logo is only marked on option 1 parts
- Tape and reel suffix (T) is not part of the package marking

DIL300-6

Package Dimensions in mm



Ozone Depleting Substances Policy Statement

It is the policy of **Vishay Semiconductor GmbH** to

1. Meet all present and future national and international statutory requirements.
2. Regularly and continuously improve the performance of our products, processes, distribution and operating systems with respect to their impact on the health and safety of our employees and the public, as well as their impact on the environment.

It is particular concern to control or eliminate releases of those substances into the atmosphere which are known as ozone depleting substances (ODSs).

The Montreal Protocol (1987) and its London Amendments (1990) intend to severely restrict the use of ODSs and forbid their use within the next ten years. Various national and international initiatives are pressing for an earlier ban on these substances.

Vishay Semiconductor GmbH has been able to use its policy of continuous improvements to eliminate the use of ODSs listed in the following documents.

1. Annex A, B and list of transitional substances of the Montreal Protocol and the London Amendments respectively
2. Class I and II ozone depleting substances in the Clean Air Act Amendments of 1990 by the Environmental Protection Agency (EPA) in the USA
3. Council Decision 88/540/EEC and 91/690/EEC Annex A, B and C (transitional substances) respectively.

Vishay Semiconductor GmbH can certify that our semiconductors are not manufactured with ozone depleting substances and do not contain such substances.

**We reserve the right to make changes to improve technical design
and may do so without further notice.**

Parameters can vary in different applications. All operating parameters must be validated for each customer application by the customer. Should the buyer use Vishay Semiconductors products for any unintended or unauthorized application, the buyer shall indemnify Vishay Semiconductors against all claims, costs, damages, and expenses, arising out of, directly or indirectly, any claim of personal damage, injury or death associated with such unintended or unauthorized use.

Vishay Semiconductor GmbH, P.O.B. 3535, D-74025 Heilbronn, Germany
Telephone: 49 (0)7131 67 2831, Fax number: 49 (0)7131 67 2423

Ozone Depleting Substances Policy Statement

It is the policy of **Vishay Semiconductor GmbH** to

1. Meet all present and future national and international statutory requirements.
2. Regularly and continuously improve the performance of our products, processes, distribution and operating systems with respect to their impact on the health and safety of our employees and the public, as well as their impact on the environment.

It is particular concern to control or eliminate releases of those substances into the atmosphere which are known as ozone depleting substances (ODSs).

The Montreal Protocol (1987) and its London Amendments (1990) intend to severely restrict the use of ODSs and forbid their use within the next ten years. Various national and international initiatives are pressing for an earlier ban on these substances.

Vishay Semiconductor GmbH has been able to use its policy of continuous improvements to eliminate the use of ODSs listed in the following documents.

1. Annex A, B and list of transitional substances of the Montreal Protocol and the London Amendments respectively
2. Class I and II ozone depleting substances in the Clean Air Act Amendments of 1990 by the Environmental Protection Agency (EPA) in the USA
3. Council Decision 88/540/EEC and 91/690/EEC Annex A, B and C (transitional substances) respectively.

Vishay Semiconductor GmbH can certify that our semiconductors are not manufactured with ozone depleting substances and do not contain such substances.

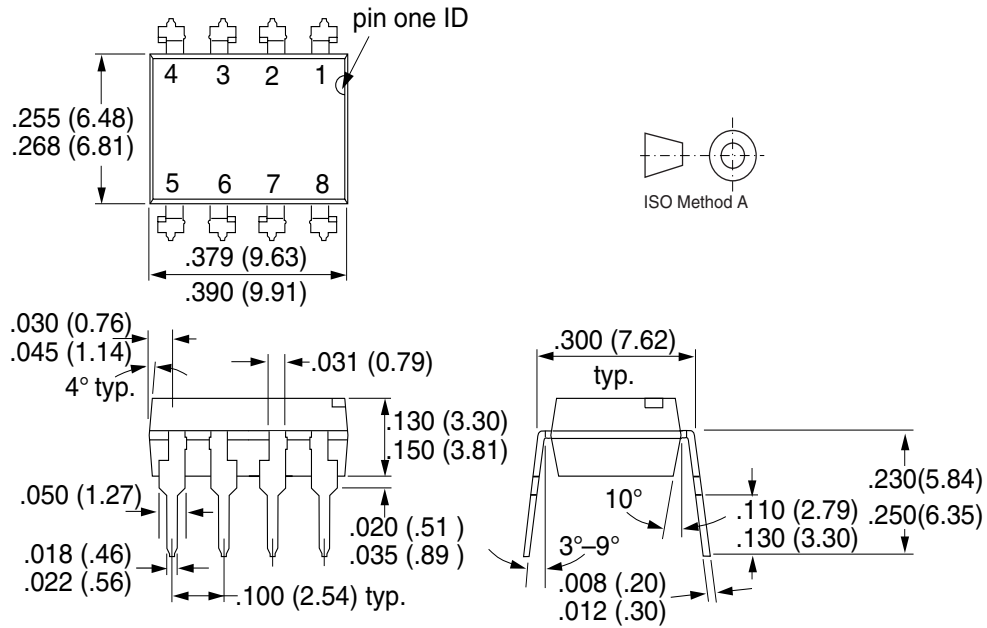
**We reserve the right to make changes to improve technical design
and may do so without further notice.**

Parameters can vary in different applications. All operating parameters must be validated for each customer application by the customer. Should the buyer use Vishay Semiconductors products for any unintended or unauthorized application, the buyer shall indemnify Vishay Semiconductors against all claims, costs, damages, and expenses, arising out of, directly or indirectly, any claim of personal damage, injury or death associated with such unintended or unauthorized use.

Vishay Semiconductor GmbH, P.O.B. 3535, D-74025 Heilbronn, Germany
Telephone: 49 (0)7131 67 2831, Fax number: 49 (0)7131 67 2423

DIP-8

Package Dimensions in Inches (mm)



i178006

Ozone Depleting Substances Policy Statement

It is the policy of **Vishay Semiconductor GmbH** to

1. Meet all present and future national and international statutory requirements.
2. Regularly and continuously improve the performance of our products, processes, distribution and operating systems with respect to their impact on the health and safety of our employees and the public, as well as their impact on the environment.

It is particular concern to control or eliminate releases of those substances into the atmosphere which are known as ozone depleting substances (ODSs).

The Montreal Protocol (1987) and its London Amendments (1990) intend to severely restrict the use of ODSs and forbid their use within the next ten years. Various national and international initiatives are pressing for an earlier ban on these substances.

Vishay Semiconductor GmbH has been able to use its policy of continuous improvements to eliminate the use of ODSs listed in the following documents.

1. Annex A, B and list of transitional substances of the Montreal Protocol and the London Amendments respectively
2. Class I and II ozone depleting substances in the Clean Air Act Amendments of 1990 by the Environmental Protection Agency (EPA) in the USA
3. Council Decision 88/540/EEC and 91/690/EEC Annex A, B and C (transitional substances) respectively.

Vishay Semiconductor GmbH can certify that our semiconductors are not manufactured with ozone depleting substances and do not contain such substances.

**We reserve the right to make changes to improve technical design
and may do so without further notice.**

Parameters can vary in different applications. All operating parameters must be validated for each customer application by the customer. Should the buyer use Vishay Semiconductors products for any unintended or unauthorized application, the buyer shall indemnify Vishay Semiconductors against all claims, costs, damages, and expenses, arising out of, directly or indirectly, any claim of personal damage, injury or death associated with such unintended or unauthorized use.

Vishay Semiconductor GmbH, P.O.B. 3535, D-74025 Heilbronn, Germany
Telephone: 49 (0)7131 67 2831, Fax number: 49 (0)7131 67 2423

Footprints

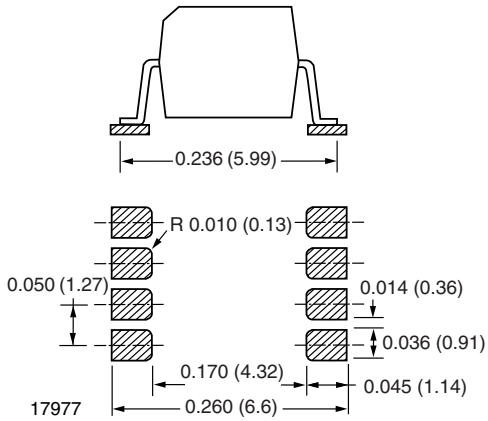
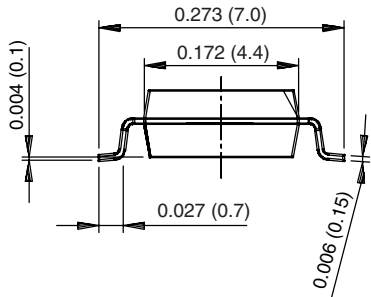
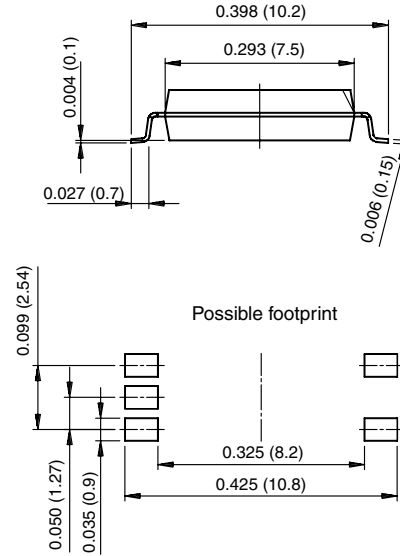


Fig. 1 - SO8A and DSO8A SMD



18403

Fig. 2 - SOP-4, Miniflat



18406

Fig. 3 - SOP-6, 5 Pin Wide Body

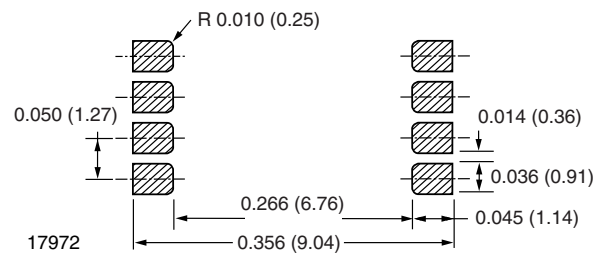
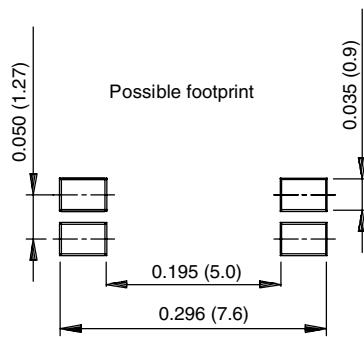


Fig. 4 - 8 Pin PCMCIA

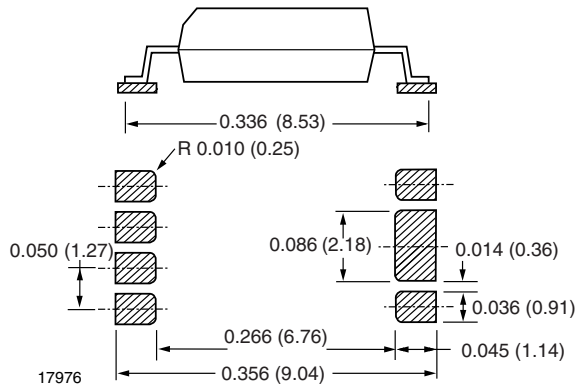


Fig. 5 - 8 Pin PCMCIA, Heat Sink

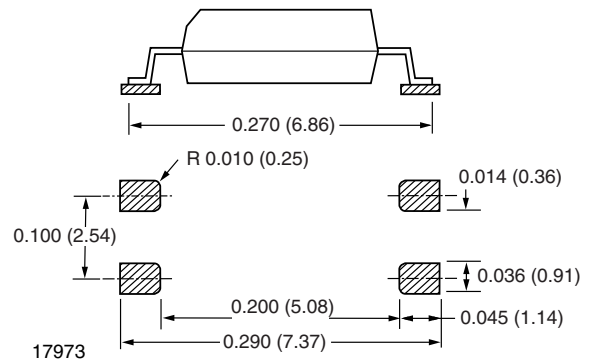


Fig. 8 - 4 Pin Mini-Flat

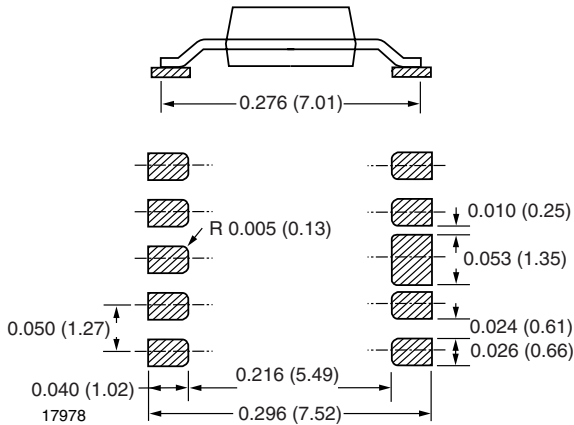


Fig. 6 - Mini Coupler

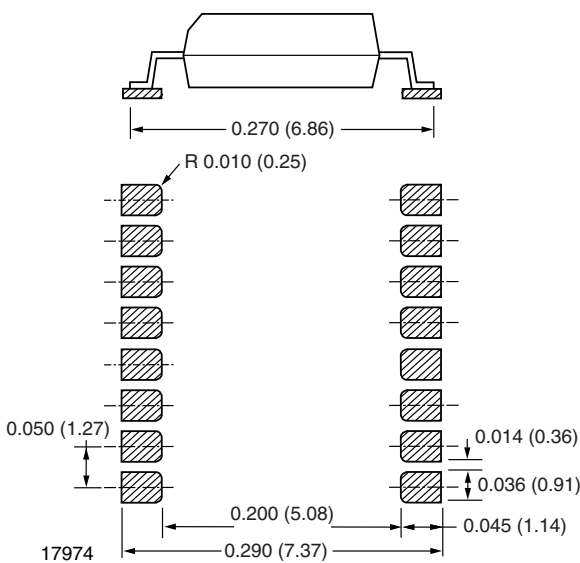


Fig. 7 - SOP-16

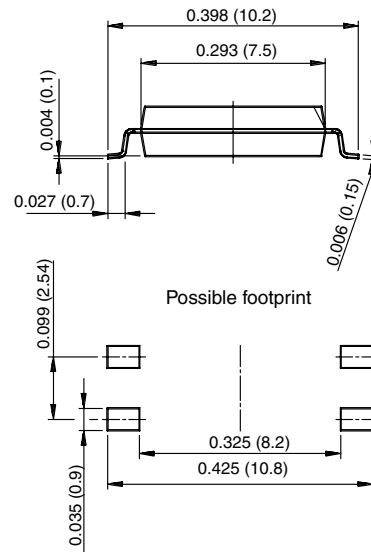


Fig. 9 - SOP-6, 4 Pin Wide Body

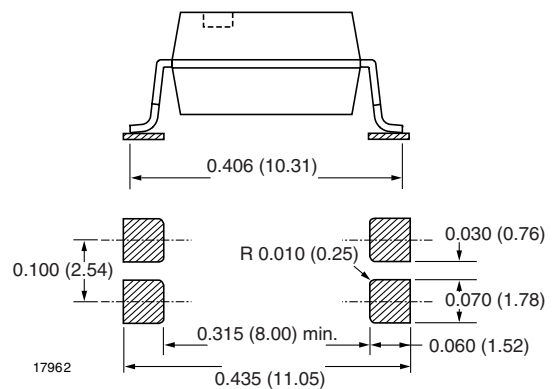


Fig. 10 - 4 Pin SMD Option 7

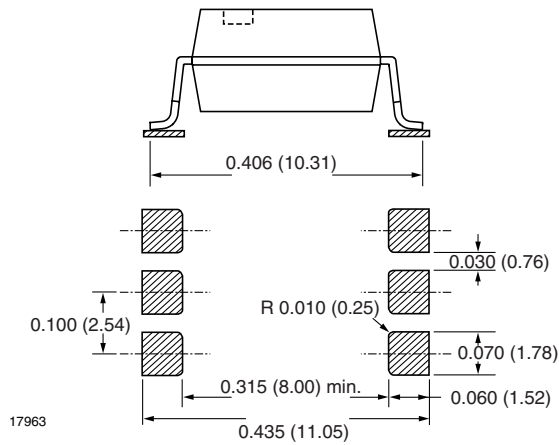


Fig. 11 - 6 Pin SMD Option 7

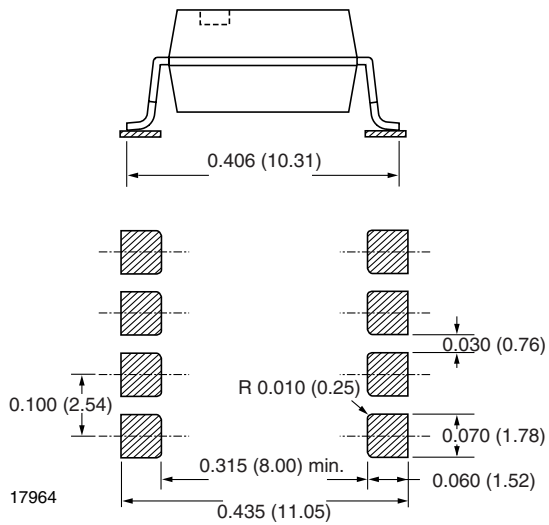


Fig. 12 - 8 Pin SMD Option 7

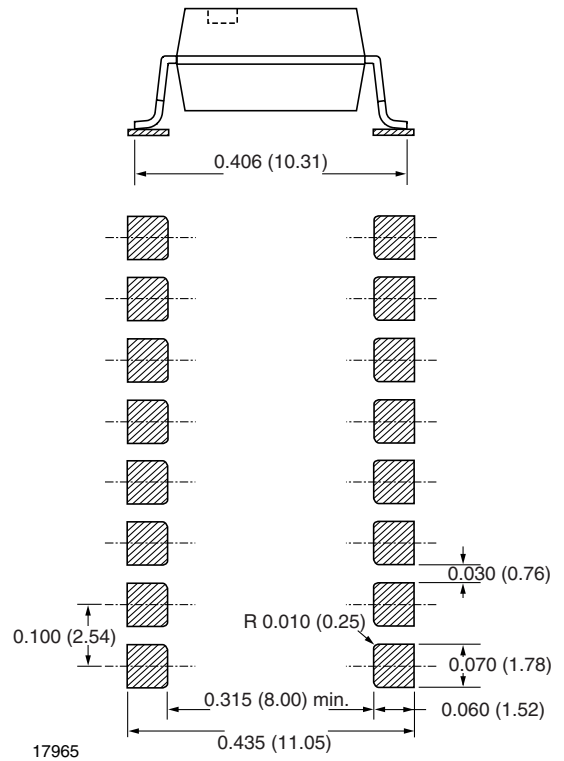


Fig. 13 - 16 Pin SMD Option 7

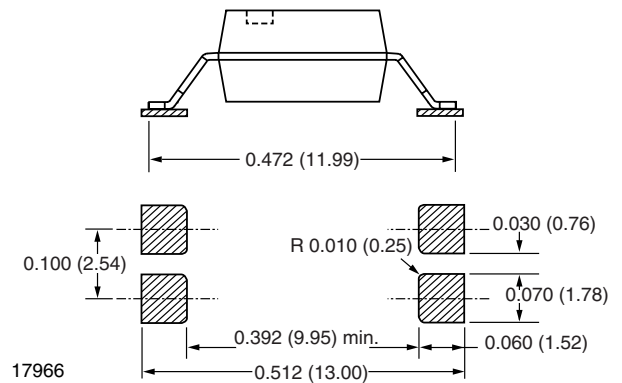


Fig. 14 - 4 Pin SMD Option 8

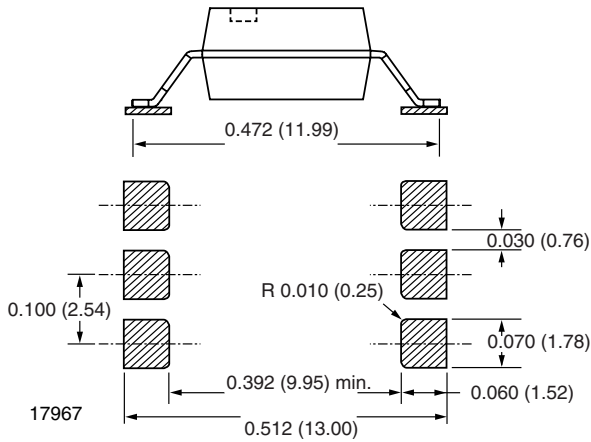


Fig. 15 - 6 Pin SMD Option 8

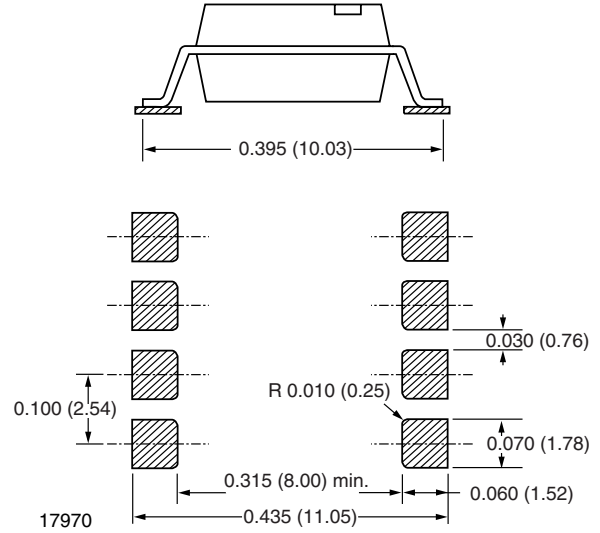


Fig. 18 - 8 Pin SMD Option 9

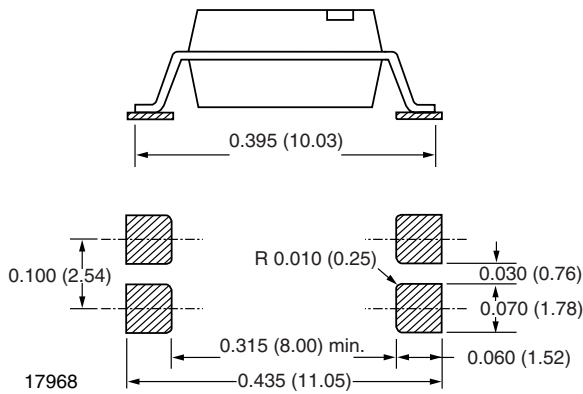


Fig. 16 - 4 Pin SMD Option 9

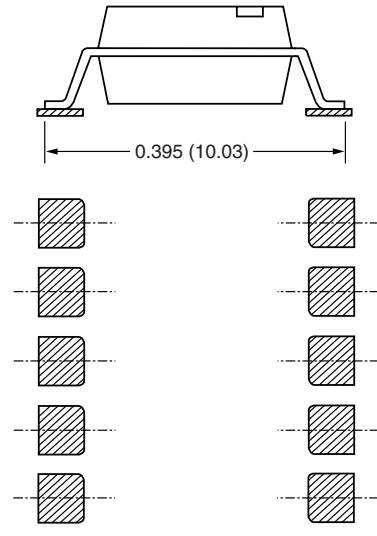


Fig. 19 - 16 Pin SMD Option 9

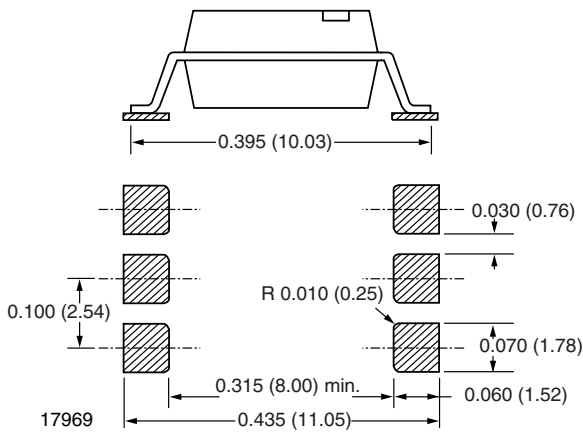


Fig. 17 - 6 Pin SMD Option 9

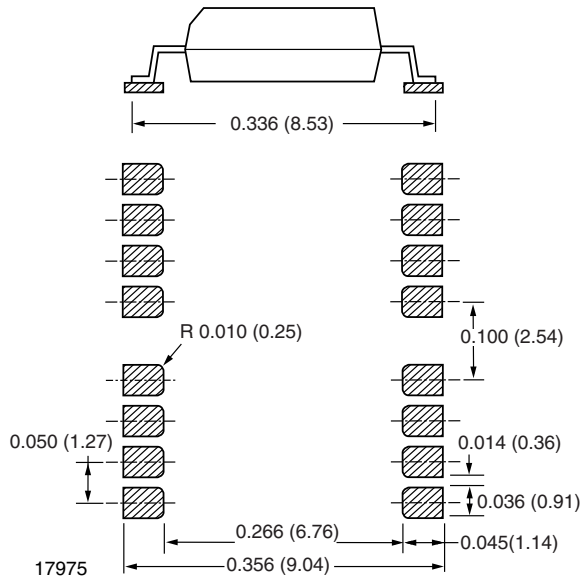


Fig. 20 - 16 Pin PCMCIA



Disclaimer

ALL PRODUCT, PRODUCT SPECIFICATIONS AND DATA ARE SUBJECT TO CHANGE WITHOUT NOTICE TO IMPROVE RELIABILITY, FUNCTION OR DESIGN OR OTHERWISE.

Vishay Intertechnology, Inc., its affiliates, agents, and employees, and all persons acting on its or their behalf (collectively, "Vishay"), disclaim any and all liability for any errors, inaccuracies or incompleteness contained in any datasheet or in any other disclosure relating to any product.

Vishay makes no warranty, representation or guarantee regarding the suitability of the products for any particular purpose or the continuing production of any product. To the maximum extent permitted by applicable law, Vishay disclaims (i) any and all liability arising out of the application or use of any product, (ii) any and all liability, including without limitation special, consequential or incidental damages, and (iii) any and all implied warranties, including warranties of fitness for particular purpose, non-infringement and merchantability.


Statements regarding the suitability of products for certain types of applications are based on Vishay's knowledge of typical requirements that are often placed on Vishay products in generic applications. Such statements are not binding statements about the suitability of products for a particular application. It is the customer's responsibility to validate that a particular product with the properties described in the product specification is suitable for use in a particular application. Parameters provided in datasheets and/or specifications may vary in different applications and performance may vary over time. All operating parameters, including typical parameters, must be validated for each customer application by the customer's technical experts. Product specifications do not expand or otherwise modify Vishay's terms and conditions of purchase, including but not limited to the warranty expressed therein.

Except as expressly indicated in writing, Vishay products are not designed for use in medical, life-saving, or life-sustaining applications or for any other application in which the failure of the Vishay product could result in personal injury or death. Customers using or selling Vishay products not expressly indicated for use in such applications do so at their own risk and agree to fully indemnify and hold Vishay and its distributors harmless from and against any and all claims, liabilities, expenses and damages arising or resulting in connection with such use or sale, including attorneys fees, even if such claim alleges that Vishay or its distributor was negligent regarding the design or manufacture of the part. Please contact authorized Vishay personnel to obtain written terms and conditions regarding products designed for such applications.

No license, express or implied, by estoppel or otherwise, to any intellectual property rights is granted by this document or by any conduct of Vishay. Product names and markings noted herein may be trademarks of their respective owners.

Looking for pricing, stock, or lifecycle information?

Click below to explore more details on WIN SOURCE:

 [View ILD66-4 on WIN SOURCE](#)

 [Vishay Information](#)

Optimize Your Supply Chain with WIN SOURCE Solutions

-  Global Sourcing Solution
-  Obsolete Management
-  Cost Control Management
-  Shortage Management
-  Alternative Solution
-  Excess Inventory Management