



**THE DATASHEET OF
TLV2775CN**



TLV277x, TLV277xA

FAMILY OF 2.7-V HIGH-SLEW-RATE RAIL-TO-RAIL OUTPUT OPERATIONAL AMPLIFIERS WITH SHUTDOWN

SLOS209G – JANUARY 1998 – REVISED FEBRUARY 2004

- High Slew Rate . . . 10.5 V/μs Typ
- High-Gain Bandwidth . . . 5.1 MHz Typ
- Supply Voltage Range 2.5 V to 5.5 V
- Rail-to-Rail Output
- 360 μV Input Offset Voltage
- Low Distortion Driving 600-Ω
0.005% THD+N
- 1 mA Supply Current (Per Channel)
- 17 nV/√Hz Input Noise Voltage
- 2 pA Input Bias Current
- Characterized From T_A = –55°C to 125°C
- Available in MSOP and SOT-23 Packages
- Micropower Shutdown Mode . . . I_{DD} < 1 μA
- Available in Q-Temp Automotive
High Reliability Automotive Applications
Configuration Control / Print Support
Qualification to Automotive Standards

description

The TLV277x CMOS operational amplifier family combines high slew rate and bandwidth, rail-to-rail output swing, high output drive, and excellent dc precision. The device provides 10.5 V/μs of slew rate and 5.1 MHz of bandwidth while only consuming 1 mA of supply current per channel. This ac performance is much higher than current competitive CMOS amplifiers. The rail-to-rail output swing and high output drive make these devices a good choice for driving the analog input or reference of analog-to-digital converters. These devices also have low distortion while driving a 600-Ω load for use in telecom systems.

These amplifiers have a 360-μV input offset voltage, a 17 nV/√Hz input noise voltage, and a 2-pA input bias current for measurement, medical, and industrial applications. The TLV277x family is also specified across an extended temperature range (–40°C to 125°C), making it useful for automotive systems, and the military temperature range (–55°C to 125°C), for military systems.

These devices operate from a 2.5-V to 5.5-V single supply voltage and are characterized at 2.7 V and 5 V. The single-supply operation and low power consumption make these devices a good solution for portable applications. The following table lists the packages available.

FAMILY PACKAGE TABLE

| DEVICE | NUMBER OF CHANNELS | PACKAGE TYPES | | | | | | | | SHUTDOWN | UNIVERSAL EVM BOARD |
|---------|--------------------|---------------|------|------|--------|-------|------|------|------|----------|---|
| | | PDIP | CDIP | SOIC | SOT-23 | TSSOP | MSOP | LCCC | CPAK | | |
| TLV2770 | 1 | 8 | — | 8 | — | — | 8 | — | — | Yes | Refer to the EVM Selection Guide (Lit# SLOU060) |
| TLV2771 | 1 | — | — | 8 | 5 | — | — | — | — | — | |
| TLV2772 | 2 | 8 | 8 | 8 | — | 8 | 8 | 20 | 10 | — | |
| TLV2773 | 2 | 14 | — | 14 | — | — | 10 | — | — | Yes | |
| TLV2774 | 4 | 14 | — | 14 | — | 14 | — | — | — | — | |
| TLV2775 | 4 | 16 | — | 16 | — | 16 | — | — | — | Yes | |

A SELECTION OF SINGLE-SUPPLY OPERATIONAL AMPLIFIER PRODUCTS†

| DEVICE | V _{DD} (V) | BW (MHz) | SLEW RATE (V/μs) | I _{DD} (per channel) (μA) | RAIL-TO-RAIL |
|---------|---------------------|----------|------------------|------------------------------------|--------------|
| TLV277X | 2.5 – 6.0 | 5.1 | 10.5 | 1000 | O |
| TLV247X | 2.7 – 6.0 | 2.8 | 1.5 | 600 | I/O |
| TLV245X | 2.7 – 6.0 | 0.22 | 0.11 | 23 | I/O |
| TLV246X | 2.7 – 6.0 | 6.4 | 1.6 | 550 | I/O |

† All specifications measured at 5 V.



Please be aware that an important notice concerning availability, standard warranty, and use in critical applications of Texas Instruments semiconductor products and disclaimers thereto appears at the end of this data sheet.

This document contains information on products in more than one phase of development. The status of each device is indicated on the page(s) specifying its electrical characteristics.



Copyright © 1998–2004, Texas Instruments Incorporated
On products compliant to MIL-PRF-38535, all parameters are tested unless otherwise noted. On all other products, production processing does not necessarily include testing of all parameters.

TLV277x, TLV277xA

FAMILY OF 2.7-V HIGH-SLEW-RATE RAIL-TO-RAIL OUTPUT OPERATIONAL AMPLIFIERS WITH SHUTDOWN

SLOS209G – JANUARY 1998 – REVISED FEBRUARY 2004

TLV2770 and TLV2771 AVAILABLE OPTIONS

| T _A | V _{IO} max AT 25°C (mV) | PACKAGED DEVICES | | | |
|----------------|----------------------------------|--------------------------|------------------|-------------------|-----------------|
| | | SMALL OUTLINE (D) | SOT-23 (DBV) | MSOP (DGK) | PLASTIC DIP (P) |
| 0°C to 70°C | 2.5 | TLV2770CD TLV2771CD | — TLV2771CDBV | TLV2770CDGK† — | TLV2770CP — |
| –40°C to 125°C | 2.5 | TLV2770ID TLV2771ID | — TLV2771IDBV | TLV2770IDGK† — | TLV2770IP — |
| | 1.6 | TLV2770AID TLV2771AID | — — | — — | TLV2770AIP — |

† This device is in the Product Preview stage of development. Please contact your local TI sales office for availability.

TLV2772 and TLV2773 AVAILABLE OPTIONS

| T _A | V _{IO} max AT 25°C (mV) | PACKAGED DEVICES | | | | |
|----------------|----------------------------------|--------------------------|------------------|------------------|-----------------|-----------------|
| | | SMALL OUTLINE (D) | MSOP (DGK) | MSOP (DGS) | PLASTIC DIP (N) | PLASTIC DIP (P) |
| 0°C to 70°C | 2.5 | TLV2772CD TLV2773CD | TLV2772CDGK — | — TLV2773CDGS | — TLV2773CN | TLV2772CP — |
| –40°C to 125°C | 2.5 | TLV2772ID TLV2773ID | TLV2772IDGK — | — TLV2773IDGS | — TLV2773IN | TLV2772IP — |
| | 1.6 | TLV2772AID TLV2773AID | — — | — — | — TLV2773AIN | TLV2772AIP — |

TLV2774 and TLV2775 AVAILABLE OPTIONS

| T _A | V _{IO} max AT 25°C (mV) | PACKAGED DEVICES | | | |
|----------------|----------------------------------|--------------------------|-----------------|-----------------|----------------------------|
| | | SMALL OUTLINE (D) | PLASTIC DIP (N) | PLASTIC DIP (P) | TSSOP (PW) |
| 0°C to 70°C | 2.7 | TLV2774CD TLV2775CD | — TLV2775CN | TLV2774CP — | TLV2774CPW TLV2775CPW |
| –40°C to 125°C | 2.7 | TLV2774ID TLV2775ID | — TLV2775IN | TLV2774IP — | TLV2774IPW TLV2775IPW |
| | 2.1 | TLV2774AID TLV2775AID | — TLV2775AIN | TLV2774AIP — | TLV2774AIPW TLV2775AIPW |

TLV2772M/Q AND TLV2772AM/Q AVAILABLE OPTIONS

| T _A | V _{IO} max AT 25°C (mV) | PACKAGED DEVICES | | | | |
|----------------|----------------------------------|-------------------|-------------------|------------------|----------------------|--------------|
| | | SMALL OUTLINE (D) | CHIP CARRIER (FK) | CERAMIC DIP (JG) | CERAMIC FLATPACK (U) | TSSOP (PW) |
| –40°C to 125°C | 2.5 | TLV2772QD‡ | — | — | — | TLV2772QPW‡ |
| | 1.6 | TLV2772AQD‡ | — | — | — | TLV2772AQPW‡ |
| –55°C to 125°C | 2.5 | TLV2772MD | TLV2772MFK | TLV2772MJG | TLV2772MU | — |
| | 1.6 | TLV2772AMD | TLV2772AMFK | TLV2772AMJG | TLV2772AMU | — |

‡ Available in tape and reel

TLV277x, TLV277xA

FAMILY OF 2.7-V HIGH-SLEW-RATE RAIL-TO-RAIL OUTPUT OPERATIONAL AMPLIFIERS WITH SHUTDOWN

SLOS209G – JANUARY 1998 – REVISED FEBRUARY 2004

TLV277x PACKAGE PINOUTS(1)

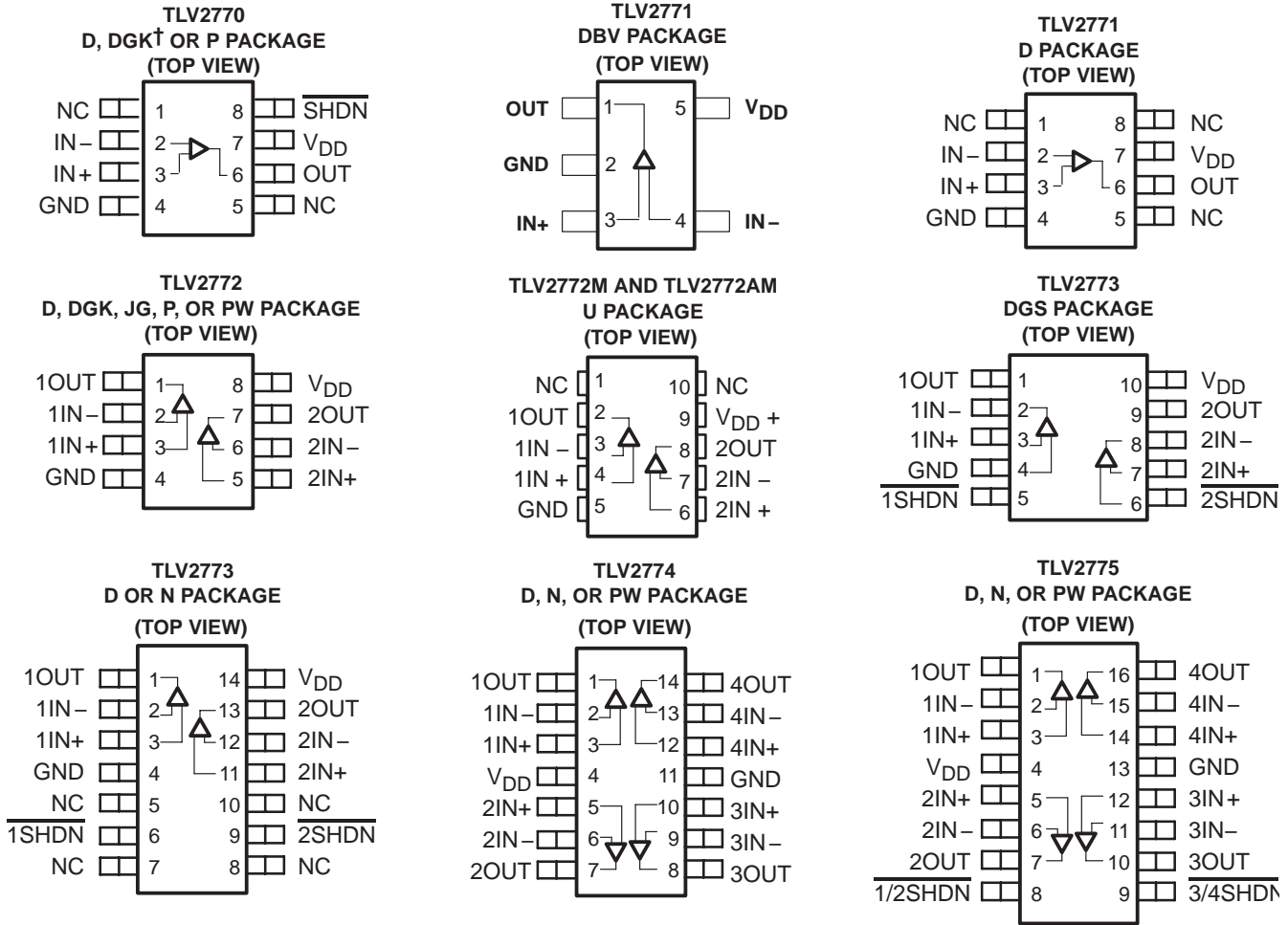

† This device is in the Product Preview stage of development. Please contact your local TI sales office for availability.
(1) SOT-23 may or may not be indicated

TYPICAL PIN 1 INDICATORS

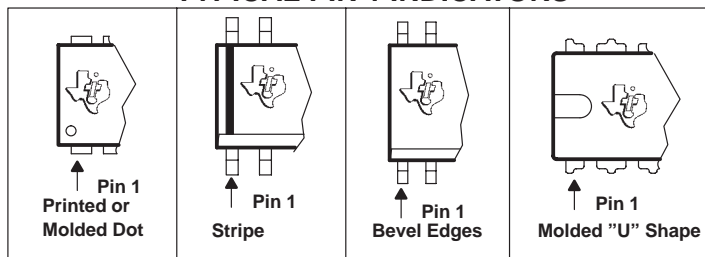

TLV277x, TLV277xA

FAMILY OF 2.7-V HIGH-SLEW-RATE RAIL-TO-RAIL OUTPUT OPERATIONAL AMPLIFIERS WITH SHUTDOWN

SLOS209G – JANUARY 1998 – REVISED FEBRUARY 2004

absolute maximum ratings over operating free-air temperature range (unless otherwise noted)†

| | |
|---|------------------------------|
| Supply voltage, V_{DD} (see Note 1) | 7 V |
| Differential input voltage, V_{ID} (see Note 2) | $\pm V_{DD}$ |
| Input voltage range, V_I (any input, see Note 1) | –0.3 V to V_{DD} |
| Input current, I_I (any input) | ± 4 mA |
| Output current, I_O | ± 50 mA |
| Total current into V_{DD+} | ± 50 mA |
| Total current out of GND | ± 50 mA |
| Duration of short-circuit current (at or below) 25°C (see Note 3) | unlimited |
| Continuous total power dissipation | See Dissipation Rating Table |
| Operating free-air temperature range, T_A : C suffix | 0°C to 70°C |
| I suffix | –40°C to 125°C |
| Q suffix | –40°C to 125°C |
| M suffix | –55°C to 125°C |
| Storage temperature range, T_{stg} | –65°C to 150°C |
| Lead temperature 1,6 mm (1/16 inch) from case for 10 seconds | 260°C |

† Stresses beyond those listed under “absolute maximum ratings” may cause permanent damage to the device. These are stress ratings only, and functional operation of the device at these or any other conditions beyond those indicated under “recommended operating conditions” is not implied. Exposure to absolute-maximum-rated conditions for extended periods may affect device reliability.

- NOTES:
1. All voltage values, except differential voltages, are with respect to GND.
 2. Differential voltages are at the noninverting input with respect to the inverting input. Excessive current flows when input is brought below GND – 0.3 V.
 3. The output may be shorted to either supply. Temperature and/or supply voltages must be limited to ensure that the maximum dissipation rating is not exceeded.

DISSIPATION RATING TABLE

| PACKAGE | $T_A \leq 25^\circ\text{C}$ POWER RATING | DERATING FACTOR ABOVE $T_A = 25^\circ\text{C}$ | $T_A = 70^\circ\text{C}$ POWER RATING | $T_A = 85^\circ\text{C}$ POWER RATING | $T_A = 125^\circ\text{C}$ POWER RATING |
|---------|---|---|--|--|---|
| D | 725 mW | 5.8 mW/°C | 464 mW | 377 mW | 145 mW |
| DBV | 437 mW | 3.5 mW/°C | 280 mW | 227 mW | 87 mW |
| DGK | 424 mW | 3.4 mW/°C | 271 mW | 220 mW | 85 mW |
| DGS | 424 mW | 3.4 mW/°C | 271 mW | 220 mW | 85 mW |
| FK | 1375 mW | 11.0 mW/°C | 672 mW | 546 mW | 210 mW |
| JG | 1050 mW | 8.4 mW/°C | 880 mW | 714 mW | 275 mW |
| N | 1150 mW | 9.2 mW/°C | 736 mW | 598 mW | 230 mW |
| P | 1000 mW | 8.0 mW/°C | 640 mW | 520 mW | 200 mW |
| PW | 700 mW | 5.6 mW/°C | 448 mW | 364 mW | 140 mW |
| U | 675 mW | 5.4 mW/°C | 432 mW | 350 mW | 135 mW |

recommended operating conditions

| | C SUFFIX | | I SUFFIX | | Q SUFFIX | | M SUFFIX | | UNIT |
|---------------------------------------|----------|-----------------|----------|-----------------|----------|-----------------|----------|-----------------|------|
| | MIN | MAX | MIN | MAX | MIN | MAX | MIN | MAX | |
| Supply voltage, V_{DD} | 2.5 | 6 | 2.5 | 6 | 2.5 | 6 | 2.5 | 6 | V |
| Input voltage range, V_I | GND | $V_{DD+} - 1.3$ | GND | $V_{DD+} - 1.3$ | GND | $V_{DD+} - 1.3$ | GND | $V_{DD+} - 1.3$ | V |
| Common-mode input voltage, V_{IC} | GND | $V_{DD+} - 1.3$ | GND | $V_{DD+} - 1.3$ | GND | $V_{DD+} - 1.3$ | GND | $V_{DD+} - 1.3$ | V |
| Operating free-air temperature, T_A | 0 | 70 | –40 | 125 | –40 | 125 | –55 | 125 | °C |

TLV277x, TLV277xA
FAMILY OF 2.7-V HIGH-SLEW-RATE RAIL-TO-RAIL OUTPUT
OPERATIONAL AMPLIFIERS WITH SHUTDOWN

SLOS209G – JANUARY 1998 – REVISED FEBRUARY 2004

electrical characteristics at specified free-air temperature, $V_{DD} = 2.7\text{ V}$ (unless otherwise noted)

| PARAMETER | | TEST CONDITIONS | T_A † | TLV277xC | | | UNIT |
|----------------|--|--|---|---------------|------------------|-----|------------------------------|
| | | | | MIN | TYP | MAX | |
| V_{IO} | Input offset voltage | $V_{IC} = 0,$ $R_S = 50\ \Omega,$ No load | $V_O = 0,$ $V_{DD} = \pm 1.35\text{ V},$ | 25°C | 0.48 | 2.5 | mV |
| | | | | Full range | 0.53 | 2.7 | |
| | | | | 25°C | 0.8 | 2.7 | |
| | | | | Full range | 0.86 | 2.9 | |
| α_{VIO} | Temperature coefficient of input offset voltage | | | 25°C to 125°C | 2 | | $\mu\text{V}/^\circ\text{C}$ |
| I_{IO} | Input offset current | $V_{IC} = 0,$ $R_S = 50\ \Omega$ | $V_O = 0,$ $V_{DD} = \pm 1.35\text{ V}$ | 25°C | 1 | 60 | pA |
| | | | | Full range | 2 | 100 | |
| I_{IB} | Input bias current | | | 25°C | 2 | 60 | pA |
| | | | | Full range | 6 | 100 | |
| V_{OH} | High-level output voltage | $I_{OH} = -0.675\text{ mA}$ | | 25°C | 2.6 | | V |
| | | | | Full range | 2.5 | | |
| | | $I_{OH} = -2.2\text{ mA}$ | | 25°C | 2.4 | | |
| | | | | Full range | 2.1 | | |
| V_{OL} | Low-level output voltage | $V_{IC} = 1.35\text{ V},$ | $I_{OL} = 0.675\text{ mA}$ | 25°C | 0.1 | | V |
| | | | | Full range | 0.2 | | |
| | | $V_{IC} = 1.35\text{ V},$ | $I_{OL} = 2.2\text{ mA}$ | 25°C | 0.21 | | |
| | | | | Full range | 0.6 | | |
| A_{VD} | Large-signal differential voltage amplification | $V_{IC} = 1.35\text{ V},$ $V_O = 0.6\text{ V to } 2.1\text{ V}$ | $R_L = 10\text{ k}\Omega,$ | 25°C | 20 | 380 | V/mV |
| | | | | Full range | 13 | | |
| $r_{i(d)}$ | Differential input resistance | | | 25°C | 10 ¹² | | Ω |
| $c_{i(c)}$ | Common-mode input capacitance | $f = 10\text{ kHz}$ | | 25°C | 8 | | pF |
| z_o | Closed-loop output impedance | $f = 100\text{ kHz},$ | $A_V = 10$ | 25°C | 25 | | Ω |
| CMRR | Common-mode rejection ratio | $V_{IC} = 0\text{ to } 1.5\text{ V},$ $R_S = 50\ \Omega$ | $V_O = V_{DD}/2,$ | 25°C | 60 | 84 | dB |
| | | | | Full range | 60 | 82 | |
| k_{SVR} | Supply voltage rejection ratio ($\Delta V_{DD} / \Delta V_{IO}$) | $V_{DD} = 2.7\text{ V to } 5\text{ V},$ No load | $V_{IC} = V_{DD}/2,$ | 25°C | 70 | 89 | dB |
| | | | | Full range | 70 | 84 | |
| I_{DD} | Supply current (per channel) | $V_O = V_{DD}/2,$ | No load | 25°C | 1 | 2 | mA |
| | | | | Full range | 2 | | |
| $I_{DD(SHDN)}$ | Supply current in shutdown (per channel) | | | 25°C | 0.8 | 1.5 | μA |
| | | | | Full range | 1.3 | 2 | |
| $V_{(ON)}$ | Turnon voltage level | $A_V = 5$ | | 25°C | 1.47 | | V |
| | | | | | 1.43 | | |
| | | | | | 1.40 | | |
| $V_{(OFF)}$ | Turnoff voltage level | $A_V = 5$ | | 25°C | 1.27 | | V |
| | | | | | 1.21 | | |
| | | | | | 1.20 | | |

† Full range is 0°C to 70°C.

TLV277x, TLV277xA
FAMILY OF 2.7-V HIGH-SLEW-RATE RAIL-TO-RAIL OUTPUT
OPERATIONAL AMPLIFIERS WITH SHUTDOWN

SLOS209G – JANUARY 1998 – REVISED FEBRUARY 2004

operating characteristics at specified free-air temperature, $V_{DD} = 2.7\text{ V}$ (unless otherwise noted)

| PARAMETER | | TEST CONDITIONS | | T_A † | TLV277xC | | | UNIT |
|------------------------|---|---|--|-------------------------------|-------------|---------|------------------------|---------------|
| | | | | | MIN | TYP | MAX | |
| SR | Slew rate at unity gain | $V_{O(PP)} = 0.8\text{ V}$, $R_L = 10\text{ k}\Omega$ | $C_L = 100\text{ pF}$ | 25°C | 5 | 9 | V/ μs | |
| | | | | Full range | 4.7 | 6 | | |
| V_n | Equivalent input noise voltage | | | 25°C | 21 | | nV/ $\sqrt{\text{Hz}}$ | |
| | | | | 25°C | 17 | | | |
| $V_{N(PP)}$ | Peak-to-peak equivalent input noise voltage | | | 25°C | 0.33 | | μV | |
| | | | | | 0.86 | | | |
| I_n | Equivalent input noise current | | $f = 100\text{ Hz}$ | 25°C | 0.6 | | fA/ $\sqrt{\text{Hz}}$ | |
| THD + N | Total harmonic distortion plus noise | $R_L = 600\ \Omega$, $f = 1\text{ kHz}$ | | 25°C | $A_V = 1$ | 0.0085% | | |
| | | | | | $A_V = 10$ | 0.025% | | |
| | | | | | $A_V = 100$ | 0.12% | | |
| Gain-bandwidth product | | | $f = 10\text{ kHz}$, $C_L = 100\text{ pF}$ | $R_L = 600\ \Omega$, 25°C | 4.8 | | MHz | |
| t_s | Settling time | $A_V = -1$, Step = 1 V, $R_L = 600\ \Omega$, $C_L = 100\text{ pF}$ | | 0.1% | 25°C | 0.186 | | μs |
| | | | | 0.01% | 25°C | 0.3 | | |
| ϕ_m | Phase margin at unity gain | | | 25°C | 46° | | | |
| | Gain margin | $R_L = 600\ \Omega$, | $C_L = 100\text{ pF}$ | 25°C | 12 | | dB | |

† Full range is 0°C to 70°C.

TLV277x, TLV277xA FAMILY OF 2.7-V HIGH-SLEW-RATE RAIL-TO-RAIL OUTPUT OPERATIONAL AMPLIFIERS WITH SHUTDOWN

SLOS209G – JANUARY 1998 – REVISED FEBRUARY 2004

electrical characteristics at specified free-air temperature, $V_{DD} = 5\text{ V}$ (unless otherwise noted)

| PARAMETER | | TEST CONDITIONS | T_A † | TLV277xC | | | UNIT |
|----------------|--|--|--|---------------|------------------|-----|------------------------------|
| | | | | MIN | TYP | MAX | |
| V_{IO} | Input offset voltage | $V_{IC} = 0,$ $R_S = 50\ \Omega,$ No load | $V_O = 0,$ $V_{DD} = \pm 2.5\text{ V},$ | 25°C | 0.5 | 2.5 | mV |
| | | | | Full range | 0.6 | 2.7 | |
| | | | | 25°C | 0.7 | 2.5 | |
| | | | | Full range | 0.78 | 2.7 | |
| α_{VIO} | Temperature coefficient of input offset voltage | | | 25°C to 125°C | 2 | | $\mu\text{V}/^\circ\text{C}$ |
| I_{IO} | Input offset current | $V_{IC} = 0,$ $R_S = 50\ \Omega$ | $V_O = 0,$ $V_{DD} = \pm 2.5\text{ V}$ | 25°C | 1 | 60 | pA |
| | | | | Full range | 2 | 100 | |
| I_{IB} | Input bias current | | | 25°C | 2 | 60 | pA |
| | | | | Full range | 6 | 100 | |
| V_{OH} | High-level output voltage | $I_{OH} = -1.3\text{ mA}$ | | 25°C | 4.9 | V | |
| | | | | Full range | 4.8 | | |
| | | $I_{OH} = -4.2\text{ mA}$ | | 25°C | 4.7 | | |
| | | | | Full range | 4.4 | | |
| V_{OL} | Low-level output voltage | $V_{IC} = 2.5\text{ V},$ | $I_{OL} = 1.3\text{ mA}$ | 25°C | 0.1 | V | |
| | | | | Full range | 0.2 | | |
| | | $V_{IC} = 2.5\text{ V},$ | $I_{OL} = 4.2\text{ mA}$ | 25°C | 0.21 | | |
| | | | | Full range | 0.6 | | |
| A_{VD} | Large-signal differential voltage amplification | $V_{IC} = 2.5\text{ V},$ $V_O = 1\text{ V to }4\text{ V}$ | $R_L = 10\text{ k}\Omega,$ | 25°C | 20 | 450 | V/mV |
| | | | | Full range | 13 | | |
| $r_{i(d)}$ | Differential input resistance | | | 25°C | 10 ¹² | | Ω |
| $c_{i(c)}$ | Common-mode input capacitance | $f = 10\text{ kHz}$ | | 25°C | 8 | | pF |
| z_o | Closed-loop output impedance | $f = 100\text{ kHz},$ | $A_V = 10$ | 25°C | 20 | | Ω |
| CMRR | Common-mode rejection ratio | $V_{IC} = 0\text{ to }3.7\text{ V},$ $R_S = 50\ \Omega$ | $V_O = V_{DD}/2,$ | 25°C | 70 | 96 | dB |
| | | | | Full range | 70 | 93 | |
| k_{SVR} | Supply voltage rejection ratio ($\Delta V_{DD} / \Delta V_{IO}$) | $V_{DD} = 2.7\text{ V to }5\text{ V},$ No load | $V_{IC} = V_{DD}/2,$ | 25°C | 70 | 89 | dB |
| | | | | Full range | 70 | 84 | |
| I_{DD} | Supply current (per channel) | $V_O = V_{DD}/2,$ | No load | 25°C | 1 | 2 | mA |
| | | | | Full range | | 2 | |
| $I_{DD(SHDN)}$ | Supply current in shutdown (per channel) | | | 25°C | 0.8 | 1.5 | μA |
| | | | | Full range | 1.3 | 2 | |
| $V_{(ON)}$ | Turnon voltage level | TLV2770 | $A_V = 5$ | 25°C | 2.59 | | V |
| | | TLV2773 | | | 2.47 | | |
| | | TLV2775 | | | 2.48 | | |
| $V_{(OFF)}$ | Turnoff voltage level | TLV2770 | $A_V = 5$ | 25°C | 2.41 | | V |
| | | TLV2773 | | | 2.32 | | |
| | | TLV2775 | | | 2.29 | | |

† Full range is 0°C to 70°C.

TLV277x, TLV277xA
FAMILY OF 2.7-V HIGH-SLEW-RATE RAIL-TO-RAIL OUTPUT
OPERATIONAL AMPLIFIERS WITH SHUTDOWN

SLOS209G – JANUARY 1998 – REVISED FEBRUARY 2004

operating characteristics at specified free-air temperature, $V_{DD} = 5\text{ V}$ (unless otherwise noted)

| PARAMETER | | TEST CONDITIONS | | T_A † | TLV277xC | | | UNIT |
|------------------------|---|---|---|-------------|----------|--------|------------------------|---------------|
| | | | | | MIN | TYP | MAX | |
| SR | Slew rate at unity gain | $V_{O(PP)} = 2\text{ V}$, $R_L = 10\text{ k}\Omega$ | $C_L = 100\text{ pF}$ | 25°C | 5 | 10.5 | V/ μs | |
| | | | | Full range | 4.7 | 6 | | |
| V_n | Equivalent input noise voltage | f = 1 kHz | | 25°C | 17 | | nV/ $\sqrt{\text{Hz}}$ | |
| | | f = 10 kHz | | 25°C | 12 | | | |
| $V_{N(PP)}$ | Peak-to-peak equivalent input noise voltage | f = 0.1 Hz to 1 Hz | | 25°C | 0.33 | | μV | |
| | | f = 0.1 Hz to 10 Hz | | | 0.86 | | | |
| I_n | Equivalent input noise current | f = 100 Hz | | 25°C | 0.6 | | fA/ $\sqrt{\text{Hz}}$ | |
| THD + N | Total harmonic distortion plus noise | $R_L = 600\ \Omega$, f = 1 kHz | | $A_V = 1$ | 25°C | 0.005% | | |
| | | | | $A_V = 10$ | | 0.016% | | |
| | | | | $A_V = 100$ | | 0.095% | | |
| Gain-bandwidth product | | f = 10 kHz, $C_L = 100\text{ pF}$ | $R_L = 600\ \Omega$ | 25°C | 5.1 | | MHz | |
| t_s | Settling time | $A_V = -1$, Step = 2 V, $R_L = 600\ \Omega$, $C_L = 100\text{ pF}$ | | 0.1% | 25°C | 0.335 | | μs |
| | | | | 0.01% | 25°C | 0.6 | | |
| ϕ_m | Phase margin at unity gain | $R_L = 600\ \Omega$, $C_L = 100\text{ pF}$ | | 25°C | 46° | | | |
| | Gain margin | | | 25°C | 12 | | dB | |
| $t_{(ON)}$ | Amplifier turnon time | TLV2770 | $A_V = 5$, $R_L = \text{Open}$, Measured to 50% point | 25°C | 1.2 | | μs | |
| | | TLV2773 | | | 2.4 | | | |
| | | TLV2775 | | | 1.9 | | | |
| $t_{(OFF)}$ | Amplifier turnoff time | TLV2770 | $A_V = 5$, $R_L = \text{Open}$, Measured to 50% point | 25°C | 335 | | ns | |
| | | TLV2773 | | | 444 | | | |
| | | TLV2775 | | | 345 | | | |

† Full range is 0°C to 70°C.

TLV277x, TLV277xA

FAMILY OF 2.7-V HIGH-SLEW-RATE RAIL-TO-RAIL OUTPUT OPERATIONAL AMPLIFIERS WITH SHUTDOWN

SLOS209G – JANUARY 1998 – REVISED FEBRUARY 2004

electrical characteristics at specified free-air temperature, $V_{DD} = 2.7\text{ V}$ (unless otherwise noted)

| PARAMETER | | TEST CONDITIONS | T_A † | TLV277xI | | | TLV277xAI | | | UNIT |
|----------------|--|--|---------------|-----------|-----|-----|-----------|-----|---------------|------------------------------|
| | | | | MIN | TYP | MAX | MIN | TYP | MAX | |
| V_{IO} | Input offset voltage | $V_{IC} = 0, V_O = 0,$ $R_S = 50\ \Omega$ $V_{DD} = \pm 1.35\text{ V},$ No load | 25°C | 0.48 | 2.5 | | 0.48 | 1.6 | mV | |
| | | | Full range | 0.53 | 2.7 | | 0.53 | 1.9 | | |
| | | | 25°C | 0.8 | 2.7 | | 0.8 | 2.1 | | |
| | | | Full range | 0.86 | 2.9 | | 0.86 | 2.2 | | |
| α_{VIO} | Temperature coefficient of input offset voltage | | 25°C to 125°C | 2 | | | 2 | | | $\mu\text{V}/^\circ\text{C}$ |
| I_{IO} | Input offset current | $V_{IC} = 0, V_O = 0,$ $R_S = 50\ \Omega$ | 25°C | 1 | 60 | | 1 | 60 | pA | |
| | | | Full range | 2 | 125 | | 2 | 125 | | |
| I_{IB} | Input bias current | | 25°C | 2 | 60 | | 2 | 60 | pA | |
| | | | Full range | 6 | 350 | | 6 | 350 | | |
| V_{OH} | High-level output voltage | $I_{OH} = -0.675\text{ mA}$ | 25°C | 2.6 | | | 2.6 | | | V |
| | | | Full range | 2.5 | | | 2.5 | | | |
| | | $I_{OH} = -2.2\text{ mA}$ | 25°C | 2.4 | | | 2.4 | | | |
| | | | Full range | 2.1 | | | 2.1 | | | |
| V_{OL} | Low-level output voltage | $V_{IC} = 1.35\text{ V},$ $I_{OL} = 0.675\text{ mA}$ | 25°C | 0.1 | | | 0.1 | | | V |
| | | | Full range | 0.2 | | | 0.2 | | | |
| | | $V_{IC} = 1.35\text{ V},$ $I_{OL} = 2.2\text{ mA}$ | 25°C | 0.21 | | | 0.21 | | | |
| | | | Full range | 0.6 | | | 0.6 | | | |
| A_{VD} | Large-signal differential voltage amplification | $V_{IC} = 1.35\text{ V},$ $R_L = 10\text{ k}\Omega,$ $V_O = 0.6\text{ V to } 2.1\text{ V}$ | 25°C | 20 | 380 | | 20 | 380 | V/mV | |
| | | | Full range | 13 | | | 13 | | | |
| $r_{i(d)}$ | Differential input resistance | | 25°C | 10^{12} | | | 10^{12} | | | Ω |
| $c_{i(c)}$ | Common-mode input capacitance | $f = 10\text{ kHz},$ | 25°C | 8 | | | 8 | | | pF |
| z_o | Closed-loop output impedance | $f = 100\text{ kHz},$ $A_V = 10$ | 25°C | 25 | | | 25 | | | Ω |
| CMRR | Common-mode rejection ratio | $V_{IC} = 0\text{ to } 1.5\text{ V},$ $V_O = V_{DD}/2,$ $R_S = 50\ \Omega$ | 25°C | 60 | 84 | | 60 | 84 | dB | |
| | | | Full range | 60 | 82 | | 60 | 82 | | |
| k_{SVR} | Supply voltage rejection ratio ($\Delta V_{DD} / \Delta V_{IO}$) | $V_{DD} = 2.7\text{ V to } 5\text{ V},$ $V_{IC} = V_{DD}/2,$ No load | 25°C | 70 | 89 | | 70 | 89 | dB | |
| | | | Full range | 70 | 84 | | 70 | 84 | | |
| I_{DD} | Supply current (per channel) | $V_O = V_{DD}/2,$ No load | 25°C | 1 | 2 | | 1 | 2 | mA | |
| | | | Full range | 2 | | | 2 | | | |
| $I_{DD(SHDN)}$ | Supply current in shutdown (per channel) | | 25°C | 0.8 | 1.5 | | 0.8 | 1.5 | μA | |
| | | | Full range | 1.3 | 2 | | 1.3 | 2 | | |

† Full range is -40°C to 125°C .

TLV277x, TLV277xA
FAMILY OF 2.7-V HIGH-SLEW-RATE RAIL-TO-RAIL OUTPUT
OPERATIONAL AMPLIFIERS WITH SHUTDOWN

SLOS209G – JANUARY 1998 – REVISED FEBRUARY 2004

electrical characteristics at specified free-air temperature, $V_{DD} = 2.7\text{ V}$ (unless otherwise noted)
(continued)

| PARAMETER | | TEST CONDITIONS | T_A^\dagger | TLV277xI | | | TLV277xAI | | | UNIT | |
|-------------|-----------------------|-----------------|---------------|----------|------|-----|-----------|------|-----|------|---|
| | | | | MIN | TYP | MAX | MIN | TYP | MAX | | |
| $V_{(ON)}$ | Turnon voltage level | TLV2770 | $A_V = 5$ | 25°C | 1.47 | | | 1.47 | | | V |
| | | TLV2773 | | | 1.43 | | | 1.43 | | | |
| | | TLV2775 | | | 1.40 | | | 1.4 | | | |
| $V_{(OFF)}$ | Turnoff voltage level | TLV2770 | $A_V = 5$ | 25°C | 1.27 | | | 1.27 | | | V |
| | | TLV2773 | | | 1.21 | | | 1.21 | | | |
| | | TLV2775 | | | 1.20 | | | 1.2 | | | |

† Full range is -40°C to 125°C .

operating characteristics at specified free-air temperature, $V_{DD} = 2.7\text{ V}$ (unless otherwise noted)

| PARAMETER | | TEST CONDITIONS | | T_A^\dagger | TLV277xI | | | TLV277xAI | | | UNIT | |
|-------------|---|---|---------------------|---------------|----------|---------|-----|-----------|---------|-----|------------------------|---------------|
| | | | | | MIN | TYP | MAX | MIN | TYP | MAX | | |
| SR | Slew rate at unity gain | $V_{O(PP)} = 0.8\text{ V}$, $C_L = 100\text{ pF}$, $R_L = 10\text{ k}\Omega$ | | 25°C | 5 | 9 | | 5 | 9 | | V/ μs | |
| | | | | Full range | 4.7 | 6 | | 4.7 | 6 | | | |
| V_n | Equivalent input noise voltage | f = 1 kHz | | 25°C | 21 | | | 21 | | | nV/ $\sqrt{\text{Hz}}$ | |
| | | f = 10 kHz | | 25°C | 17 | | | 17 | | | | |
| $V_{N(PP)}$ | Peak-to-peak equivalent input noise voltage | f = 0.1 Hz to 1 Hz | | 25°C | 0.33 | | | 0.33 | | | μV | |
| | | f = 0.1 Hz to 10 Hz | | 25°C | 0.86 | | | 0.86 | | | μV | |
| I_n | Equivalent input noise current | f = 100 Hz | | 25°C | 0.6 | | | 0.6 | | | fA/ $\sqrt{\text{Hz}}$ | |
| THD + N | Total harmonic distortion plus noise | $R_L = 600\ \Omega$, f = 1 kHz | | $A_V = 1$ | 25°C | 0.0085% | | | 0.0085% | | | |
| | | | | $A_V = 10$ | | 0.025% | | | 0.025% | | | |
| | | | | $A_V = 100$ | | 0.12% | | | 0.12% | | | |
| | Gain-bandwidth product | f = 10 kHz, $C_L = 100\text{ pF}$ | $R_L = 600\ \Omega$ | 25°C | 4.8 | | | 4.8 | | | MHz | |
| t_s | Settling time | $A_V = -1$, Step = 0.85 V to 1.85 V, $R_L = 600\ \Omega$, $C_L = 100\text{ pF}$ | | 0.1% | 25°C | 0.186 | | | 0.186 | | | μs |
| | | | | 0.01% | 25°C | 3.92 | | | 3.92 | | | |
| ϕ_m | Phase margin at unity gain | $R_L = 600\ \Omega$, $C_L = 100\text{ pF}$ | | 25°C | 46° | | | 46° | | | | |
| | Gain margin | | | 25°C | 12 | | | 12 | | | | dB |

† Full range is -40°C to 125°C .

TLV277x, TLV277xA

FAMILY OF 2.7-V HIGH-SLEW-RATE RAIL-TO-RAIL OUTPUT OPERATIONAL AMPLIFIERS WITH SHUTDOWN

SLOS209G – JANUARY 1998 – REVISED FEBRUARY 2004

electrical characteristics at specified free-air temperature, $V_{DD} = 5\text{ V}$ (unless otherwise noted)

| PARAMETER | | TEST CONDITIONS | T_A † | TLV277xI | | | TLV277xAI | | | UNIT |
|----------------|--|--|---------------|-----------|-----|-----------|-----------|------------------------------|-----|------|
| | | | | MIN | TYP | MAX | MIN | TYP | MAX | |
| V_{IO} | Input offset voltage | $V_{IC} = 0$, No load $V_O = 0$, $R_S = 50\ \Omega$, $V_{DD} = \pm 2.5\text{ V}$ | 25°C | 0.5 | 2.5 | 0.5 | 1.6 | mV | | |
| | | | Full range | 0.6 | 2.7 | 0.6 | 1.9 | | | |
| | | | 25°C | 0.7 | 2.5 | 0.7 | 2.1 | | | |
| | | | Full range | 0.78 | 2.7 | 0.78 | 2.2 | | | |
| α_{VIO} | Temperature coefficient of input offset voltage | | 25°C to 125°C | 2 | | 2 | | $\mu\text{V}/^\circ\text{C}$ | | |
| I_{IO} | Input offset current | $V_{IC} = 0$, $V_O = 0$, $R_S = 50\ \Omega$, $V_{DD} = \pm 2.5\text{ V}$ | 25°C | 1 | 60 | 1 | 60 | pA | | |
| | | | Full range | 2 | 125 | 2 | 125 | | | |
| I_{IB} | Input bias current | $V_{IC} = 0$, $V_O = 0$, $R_S = 50\ \Omega$, $V_{DD} = \pm 2.5\text{ V}$ | 25°C | 2 | 60 | 2 | 60 | pA | | |
| | | | Full range | 6 | 350 | 6 | 350 | | | |
| V_{OH} | High-level output voltage | $I_{OH} = -1.3\text{ mA}$ | 25°C | 4.9 | | 4.9 | | V | | |
| | | | Full range | 4.8 | | 4.8 | | | | |
| | | | 25°C | 4.7 | | 4.7 | | | | |
| | | | Full range | 4.4 | | 4.4 | | | | |
| V_{OL} | Low-level output voltage | $V_{IC} = 2.5\text{ V}$, $I_{OL} = 1.3\text{ mA}$ | 25°C | 0.1 | | 0.1 | | V | | |
| | | | Full range | 0.2 | | 0.2 | | | | |
| | | | 25°C | 0.21 | | 0.21 | | | | |
| | | | Full range | 0.6 | | 0.6 | | | | |
| A_{VD} | Large-signal differential voltage amplification | $V_{IC} = 2.5\text{ V}$, $R_L = 10\text{ k}\Omega$, $V_O = 1\text{ V to }4\text{ V}$ | 25°C | 20 | 450 | 20 | 450 | V/mV | | |
| | | | Full range | 13 | | 13 | | | | |
| $r_{i(d)}$ | Differential input resistance | | 25°C | 10^{12} | | 10^{12} | | Ω | | |
| $C_{i(c)}$ | Common-mode input capacitance | $f = 10\text{ kHz}$ | 25°C | 8 | | 8 | | pF | | |
| z_o | Closed-loop output impedance | $f = 100\text{ kHz}$, $A_V = 10$ | 25°C | 20 | | 20 | | Ω | | |
| CMRR | Common-mode rejection ratio | $V_{IC} = 0\text{ to }3.7\text{ V}$, $V_O = V_{DD}/2$, $R_S = 50\ \Omega$ | 25°C | 60 | 96 | 70 | 96 | dB | | |
| | | | Full range | 60 | 93 | 70 | 93 | | | |
| k_{SVR} | Supply voltage rejection ratio ($\Delta V_{DD} / \Delta V_{IO}$) | $V_{DD} = 2.7\text{ V to }5\text{ V}$, $V_{IC} = V_{DD}/2$, No load | 25°C | 70 | 89 | 70 | 89 | dB | | |
| | | | Full range | 70 | 84 | 70 | 84 | | | |
| I_{DD} | Supply current (per channel) | $V_O = V_{DD}/2$, No load | 25°C | 1 | 2 | 1 | 2 | mA | | |
| | | | Full range | 2 | | 2 | | | | |
| $I_{DD(SHDN)}$ | Supply current shutdown (per channel) | | 25°C | 0.8 | 1.5 | 0.8 | 1.5 | μA | | |
| | | | Full range | 1.3 | 2 | 1.3 | 2 | | | |

† Full range is -40°C to 125°C .

TLV277x, TLV277xA
FAMILY OF 2.7-V HIGH-SLEW-RATE RAIL-TO-RAIL OUTPUT
OPERATIONAL AMPLIFIERS WITH SHUTDOWN

SLOS209G – JANUARY 1998 – REVISED FEBRUARY 2004

electrical characteristics at specified free-air temperature, $V_{DD} = 5\text{ V}$ (unless otherwise noted)
(continued)

| PARAMETER | | TEST CONDITIONS | T_A^\dagger | TLV277xI | | | TLV277xAI | | | UNIT | |
|-------------|-----------------------|-----------------|---------------|----------|------|-----|-----------|------|-----|------|---|
| | | | | MIN | TYP | MAX | MIN | TYP | MAX | | |
| $V_{(ON)}$ | Turnon voltage level | TLV2770 | $A_V = 5$ | 25°C | 2.59 | | | 2.59 | | | V |
| | | TLV2773 | | | 2.47 | | | 2.47 | | | |
| | | TLV2775 | | | 2.48 | | | 2.48 | | | |
| $V_{(OFF)}$ | Turnoff voltage level | TLV2770 | $A_V = 5$ | 25°C | 2.41 | | | 2.41 | | | V |
| | | TLV2773 | | | 2.32 | | | 2.32 | | | |
| | | TLV2775 | | | 2.29 | | | 2.29 | | | |

† Full range is -40°C to 125°C .

operating characteristics at specified free-air temperature, $V_{DD} = 5\text{ V}$ (unless otherwise noted)

| PARAMETER | | TEST CONDITIONS | | T_A^\dagger | TLV277xI | | | TLV277xAI | | | UNIT | |
|------------------------|---|---|---|---------------|----------|-------|-----|-----------|-------|-----|------------------------|---------------|
| | | | | | MIN | TYP | MAX | MIN | TYP | MAX | | |
| SR | Slew rate at unity gain | $V_{O(PP)} = 1.5\text{ V}$, $C_L = 100\text{ pF}$, $R_L = 10\text{ k}\Omega$ | | 25°C | 5 | 10.5 | | 5 | 10.5 | | V/ μs | |
| | | | | Full range | 4.7 | 6 | | 4.7 | 6 | | | |
| V_n | Equivalent input noise voltage | f = 1 kHz | | 25°C | 17 | | | 17 | | | nV/ $\sqrt{\text{Hz}}$ | |
| | | f = 10 kHz | | 25°C | 12 | | | 12 | | | | |
| $V_{N(PP)}$ | Peak-to-peak equivalent input noise voltage | f = 0.1 Hz to 1 Hz | | 25°C | 0.33 | | | 0.33 | | | μV | |
| | | f = 0.1 Hz to 10 Hz | | 25°C | 0.86 | | | 0.86 | | | μV | |
| I_n | Equivalent input noise current | f = 100 Hz | | 25°C | 0.6 | | | 0.6 | | | fA/ $\sqrt{\text{Hz}}$ | |
| THD + N | Total harmonic distortion plus noise | $R_L = 600\ \Omega$, f = 1 kHz | $A_V = 1$ | 25°C | 0.005% | | | 0.005% | | | | |
| | | | $A_V = 10$ | | 0.016% | | | 0.016% | | | | |
| | | | $A_V = 100$ | | 0.095% | | | 0.095% | | | | |
| Gain-bandwidth product | | f = 10 kHz, $C_L = 100\text{ pF}$ | $R_L = 600\ \Omega$ | 25°C | 5.1 | | | 5.1 | | | MHz | |
| t_s | Settling time | $A_V = -1$, Step = 1.5 V to 3.5 V, $R_L = 600\ \Omega$, $C_L = 100\text{ pF}$ | | 0.1% | 25°C | 0.134 | | | 0.134 | | | μs |
| | | | | 0.01% | 25°C | 1.97 | | | 1.97 | | | |
| ϕ_m | Phase margin at unity gain | $R_L = 600\ \Omega$, $C_L = 100\text{ pF}$ | | 25°C | 46° | | | 46° | | | | |
| | Gain margin | | | 25°C | 12 | | | 12 | | | dB | |
| $t_{(ON)}$ | Amplifier turnon time | TLV2770 | $A_V = 5$, $R_L = \text{Open}$, Measured to 50% point | 25°C | 1.2 | | | 1.2 | | | μs | |
| | | TLV2773 | | | 2.4 | | | 2.4 | | | | |
| | | TLV2775 | | | 1.9 | | | 1.9 | | | | |
| $t_{(OFF)}$ | Amplifier turnoff time | TLV2770 | $A_V = 5$, $R_L = \text{Open}$, Measured to 50% point | 25°C | 335 | | | 335 | | | ns | |
| | | TLV2773 | | | 444 | | | 444 | | | | |
| | | TLV2775 | | | 345 | | | 345 | | | | |

† Full range is -40°C to 125°C .

TLV277x, TLV277xA
FAMILY OF 2.7-V HIGH-SLEW-RATE RAIL-TO-RAIL OUTPUT
OPERATIONAL AMPLIFIERS WITH SHUTDOWN

SLOS209G – JANUARY 1998 – REVISED FEBRUARY 2004

electrical characteristics at specified free-air temperature, $V_{DD} = 2.7\text{ V}$ (unless otherwise noted)

| PARAMETER | TEST CONDITIONS | T_A † | TLV2772Q TLV2772M | | | TLV2772AQ TLV2772AM | | | UNIT |
|--|--|-------------------------------------|----------------------|-------------|-----|------------------------|-------------|-----|------------------------------|
| | | | MIN | TYP | MAX | MIN | TYP | MAX | |
| V_{IO} Input offset voltage | | 25°C | 0.44 | 2.5 | | 0.44 | 1.6 | mV | |
| | | Full range | 0.47 | 2.7 | | 0.47 | 1.9 | | |
| α_{VIO} Temperature coefficient of input offset voltage | $V_{DD} = \pm 1.35\text{ V}$, $V_{IC} = 0$, $R_S = 50\ \Omega$ | $V_O = 0$, 25°C to 125°C | 2 | | | 2 | | | $\mu\text{V}/^\circ\text{C}$ |
| I_{IO} Input offset current | | 25°C | 1 | 60 | | 1 | 60 | pA | |
| | Full range | 2 | 125 | | 2 | 125 | | | |
| I_{IB} Input bias current | | 25°C | 2 | 60 | | 2 | 60 | pA | |
| | | Full range | 6 | 350 | | 6 | 350 | | |
| V_{ICR} Common-mode input voltage range | CMRR > 60 dB, $R_S = 50\ \Omega$ | 25°C | 0 to 1.4 | -0.3 to 1.7 | | 0 to 1.4 | -0.3 to 1.7 | V | |
| | | Full range | 0 to 1.4 | -0.3 to 1.7 | | 0 to 1.4 | -0.3 to 1.7 | | |
| V_{OH} High-level output voltage | $I_{OH} = -0.675\text{ mA}$ | 25°C | 2.6 | | | 2.6 | | | V |
| | | Full range | 2.45 | | | 2.45 | | | |
| | $I_{OH} = -2.2\text{ mA}$ | 25°C | 2.4 | | | 2.4 | | | |
| | | Full range | 2.1 | | | 2.1 | | | |
| V_{OL} Low-level output voltage | $V_{IC} = 1.35\text{ V}$, $I_{OL} = 0.675\text{ mA}$ | 25°C | 0.1 | | | 0.1 | | | V |
| | | Full range | 0.2 | | | 0.2 | | | |
| | $V_{IC} = 1.35\text{ V}$, $I_{OL} = 2.2\text{ mA}$ | 25°C | 0.21 | | | 0.21 | | | |
| | | Full range | 0.6 | | | 0.6 | | | |
| A_{VD} Large-signal differential voltage amplification | $V_{IC} = 1.35\text{ V}$, $V_O = 0.6\text{ V to } 2.1\text{ V}$ | $R_L = 10\text{ k}\Omega, \ddagger$ | 25°C | 20 | 380 | | 20 | 380 | V/mV |
| | | | Full range | 13 | | | 13 | | |
| $r_{i(d)}$ Differential input resistance | | 25°C | 10^{12} | | | 10^{12} | | | Ω |
| $C_{i(c)}$ Common-mode input capacitance | $f = 10\text{ kHz}$, | 25°C | 8 | | | 8 | | | pF |
| z_o Closed-loop output impedance | $f = 100\text{ kHz}$, $A_V = 10$ | 25°C | 25 | | | 25 | | | Ω |
| CMRR Common-mode rejection ratio | $V_{IC} = V_{ICR}(\text{min})$, $R_S = 50\ \Omega$ | $V_O = 1.5\text{ V}$, | 25°C | 60 | 84 | | 60 | 84 | dB |
| | | | Full range | 60 | 82 | | 60 | 82 | |
| k_{SVR} Supply voltage rejection ratio ($\Delta V_{DD} / \Delta V_{IO}$) | $V_{DD} = 2.7\text{ V to } 5\text{ V}$, No load | $V_{IC} = V_{DD}/2$, | 25°C | 70 | 89 | | 70 | 89 | dB |
| | | | Full range | 70 | 84 | | 70 | 84 | |
| I_{DD} Supply current (per channel) | $V_O = 1.5\text{ V}$, No load | 25°C | 1 | 2 | | 1 | 2 | mA | |
| | | Full range | | 2 | | | 2 | | |

† Full range is -40°C to 125°C for Q level part, -55°C to 125°C for M level part.

‡ Referenced to 1.35 V

TLV277x, TLV277xA
FAMILY OF 2.7-V HIGH-SLEW-RATE RAIL-TO-RAIL OUTPUT
OPERATIONAL AMPLIFIERS WITH SHUTDOWN

SLOS209G – JANUARY 1998 – REVISED FEBRUARY 2004

operating characteristics at specified free-air temperature, $V_{DD} = 2.7\text{ V}$ (unless otherwise noted)

| PARAMETER | TEST CONDITIONS | T_A † | TLV2772Q TLV2772M | | | TLV2772AQ TLV2772AM | | | UNIT | |
|-------------|---|---|-------------------------------|-------------|-----|------------------------|---------|-----|------------------|------------------------|
| | | | MIN | TYP | MAX | MIN | TYP | MAX | | |
| SR | Slew rate at unity gain | $V_{O(PP)} = 0.8\text{ V}$, $C_L = 100\text{ pF}$, $R_L = 10\text{ k}\Omega$ | 25°C | 5 | 9 | | 5 | 9 | V/ μs | |
| | | | Full range | 4.7 | 6 | | 4.7 | 6 | | |
| V_n | Equivalent input noise voltage | | 25°C | 21 | | | 21 | | | nV/ $\sqrt{\text{Hz}}$ |
| | | | 25°C | 17 | | | 17 | | | |
| $V_{N(PP)}$ | Peak-to-peak equivalent input noise voltage | | 25°C | 0.33 | | | 0.33 | | | μV |
| | | | 25°C | 0.86 | | | 0.86 | | | μV |
| I_n | Equivalent input noise current | | 25°C | 0.6 | | | 0.6 | | | fA/ $\sqrt{\text{Hz}}$ |
| THD + N | Total harmonic distortion plus noise | $R_L = 600\ \Omega$, $f = 1\text{ kHz}$ | 25°C | $A_V = 1$ | | | 0.0085% | | | |
| | | | | $A_V = 10$ | | | 0.025% | | | |
| | | | | $A_V = 100$ | | | 0.12% | | | |
| | Gain-bandwidth product | $f = 10\text{ kHz}$, $C_L = 100\text{ pF}$ | $R_L = 600\ \Omega$, 25°C | 4.8 | | | 4.8 | | | MHz |
| t_s | Settling time | $A_V = -1$, Step = 0.85 V to 1.85 V, $R_L = 600\ \Omega$, $C_L = 100\text{ pF}$ | 25°C | 0.1% | | | 0.186 | | | μs |
| | | | 25°C | 0.01% | | | 3.92 | | | |
| ϕ_m | Phase margin at unity gain | $R_L = 600\ \Omega$, $C_L = 100\text{ pF}$ | 25°C | 46° | | | 46° | | | |
| | Gain margin | | 25°C | 12 | | | 12 | | | |

† Full range is -40°C to 125°C for Q level part, -55°C to 125°C for M level part.

TLV277x, TLV277xA

FAMILY OF 2.7-V HIGH-SLEW-RATE RAIL-TO-RAIL OUTPUT OPERATIONAL AMPLIFIERS WITH SHUTDOWN

SLOS209G – JANUARY 1998 – REVISED FEBRUARY 2004

electrical characteristics at specified free-air temperature, $V_{DD} = 5\text{ V}$ (unless otherwise noted)

| PARAMETER | TEST CONDITIONS | T_A † | TLV2772Q TLV2772M | | | TLV2772AQ TLV2772AM | | | UNIT |
|--|--|-------------------------------------|----------------------|-------------|-----|------------------------|-------------|-----|------------------------------|
| | | | MIN | TYP | MAX | MIN | TYP | MAX | |
| V_{IO} Input offset voltage | $V_{DD} = \pm 2.5\text{ V}$, $V_{IC} = 0$, $V_O = 0$, $R_S = 50\ \Omega$ | 25°C | 0.36 | 2.5 | | 0.36 | 1.6 | mV | |
| | | Full range | 0.4 | 2.7 | | 0.4 | 1.9 | | |
| α_{VIO} Temperature coefficient of input offset voltage | | 25°C to 125°C | 2 | | | 2 | | | $\mu\text{V}/^\circ\text{C}$ |
| I_{IO} Input offset current | | 25°C | 1 | 60 | | 1 | 60 | pA | |
| | | Full range | 2 | 125 | | 2 | 125 | | |
| I_{IB} Input bias current | | 25°C | 2 | 60 | | 2 | 60 | pA | |
| | Full range | 6 | 350 | | 6 | 350 | | | |
| V_{ICR} Common-mode input voltage range | CMRR > 60 dB, $R_S = 50\ \Omega$ | 25°C | 0 to 3.7 | -0.3 to 3.8 | | 0 to 3.7 | -0.3 to 3.8 | V | |
| | | Full range | 0 to 3.7 | -0.3 to 3.8 | | 0 to 3.7 | -0.3 to 3.8 | | |
| V_{OH} High-level output voltage | $I_{OH} = -1.3\text{ mA}$ | 25°C | 4.9 | | | 4.9 | | | V |
| | | Full range | 4.8 | | | 4.8 | | | |
| | $I_{OH} = -4.2\text{ mA}$ | 25°C | 4.7 | | | 4.7 | | | |
| | | Full range | 4.4 | | | 4.4 | | | |
| V_{OL} Low-level output voltage | $V_{IC} = 2.5\text{ V}$, $I_{OL} = 1.3\text{ mA}$ | 25°C | 0.1 | | | 0.1 | | | V |
| | | Full range | 0.2 | | | 0.2 | | | |
| | $V_{IC} = 2.5\text{ V}$, $I_{OL} = 4.2\text{ mA}$ | 25°C | 0.21 | | | 0.21 | | | |
| | | Full range | 0.6 | | | 0.6 | | | |
| A_{VD} Large-signal differential voltage amplification | $V_{IC} = 2.5\text{ V}$, $V_O = 1\text{ V to }4\text{ V}$ | $R_L = 10\text{ k}\Omega, \ddagger$ | 25°C | 20 | 450 | | 20 | 450 | V/mV |
| | | | Full range | 13 | | | 13 | | |
| $r_{i(d)}$ Differential input resistance | | 25°C | 10^{12} | | | 10^{12} | | | Ω |
| $C_{i(c)}$ Common-mode input capacitance | $f = 10\text{ kHz}$, | 25°C | 8 | | | 8 | | | pF |
| z_o Closed-loop output impedance | $f = 100\text{ kHz}$, $A_V = 10$ | 25°C | 20 | | | 20 | | | Ω |
| CMRR Common-mode rejection ratio | $V_{IC} = V_{ICR}(\text{min})$, $R_S = 50\ \Omega$ | $V_O = 3.7\text{ V}$, | 25°C | 60 | 96 | | 60 | 96 | dB |
| | | | Full range | 60 | 93 | | 60 | 93 | |
| k_{SVR} Supply voltage rejection ratio ($\Delta V_{DD} / \Delta V_{IO}$) | $V_{DD} = 2.7\text{ V to }5\text{ V}$, No load | $V_{IC} = V_{DD}/2$, | 25°C | 70 | 89 | | 70 | 89 | dB |
| | | | Full range | 70 | 84 | | 70 | 84 | |
| I_{DD} Supply current (per channel) | $V_O = 1.5\text{ V}$, No load | 25°C | 1 | 2 | | 1 | 2 | mA | |
| | | Full range | | 2 | | | 2 | | |

† Full range is -40°C to 125°C for Q level part, -55°C to 125°C for M level part.

‡ Referenced to 2.5 V

TLV277x, TLV277xA
FAMILY OF 2.7-V HIGH-SLEW-RATE RAIL-TO-RAIL OUTPUT
OPERATIONAL AMPLIFIERS WITH SHUTDOWN

SLOS209G – JANUARY 1998 – REVISED FEBRUARY 2004

operating characteristics at specified free-air temperature, $V_{DD} = 5\text{ V}$ (unless otherwise noted)

| PARAMETER | TEST CONDITIONS | T_A † | TLV2772Q TLV2772M | | | TLV2772AQ TLV2772AM | | | UNIT | |
|-------------|---|---|-------------------------------|-------------|------|------------------------|--------|------|------------------|------------------------|
| | | | MIN | TYP | MAX | MIN | TYP | MAX | | |
| SR | Slew rate at unity gain | $V_{O(PP)} = 1.5\text{ V}$, $C_L = 100\text{ pF}$, $R_L = 10\text{ k}\Omega$ | 25°C | 5 | 10.5 | | 5 | 10.5 | V/ μs | |
| | | | Full range | 4.7 | 6 | | 4.7 | 6 | | |
| V_n | Equivalent input noise voltage | | 25°C | 17 | | | 17 | | | nV/ $\sqrt{\text{Hz}}$ |
| | | | 25°C | 12 | | | 12 | | | |
| $V_{N(PP)}$ | Peak-to-peak equivalent input noise voltage | | 25°C | 0.33 | | | 0.33 | | | μV |
| | | | 25°C | 0.86 | | | 0.86 | | | μV |
| I_n | Equivalent input noise current | | 25°C | 0.6 | | | 0.6 | | | fA/ $\sqrt{\text{Hz}}$ |
| THD + N | Total harmonic distortion plus noise | $R_L = 600\ \Omega$, $f = 1\text{ kHz}$ | 25°C | $A_V = 1$ | | | 0.005% | | | |
| | | | | $A_V = 10$ | | | 0.016% | | | |
| | | | | $A_V = 100$ | | | 0.095% | | | |
| | Gain-bandwidth product | $f = 10\text{ kHz}$, $C_L = 100\text{ pF}$ | $R_L = 600\ \Omega$, 25°C | 5.1 | | | 5.1 | | | MHz |
| t_s | Settling time | $A_V = -1$, Step = 1.5 V to 3.5 V, $R_L = 600\ \Omega$, $C_L = 100\text{ pF}$ | 25°C | 0.134 | | | 0.134 | | | μs |
| | | | 25°C | 1.97 | | | 1.97 | | | |
| ϕ_m | Phase margin at unity gain | $R_L = 600\ \Omega$, $C_L = 100\text{ pF}$ | 25°C | 46° | | | 46° | | | |
| | Gain margin | | 25°C | 12 | | | 12 | | | |

† Full range is -40°C to 125°C for Q level part, -55°C to 125°C for M level part.

TLV277x, TLV277xA
FAMILY OF 2.7-V HIGH-SLEW-RATE RAIL-TO-RAIL OUTPUT
OPERATIONAL AMPLIFIERS WITH SHUTDOWN

SLOS209G – JANUARY 1998 – REVISED FEBRUARY 2004

TYPICAL CHARACTERISTICS

Table of Graphs

| | | | FIGURE |
|-----------------|--|-----------------------------------|-------------------------|
| V_{IO} | Input offset voltage | Distribution | 1,2 |
| | | vs Common-mode input voltage | 3,4 |
| | | Distribution | 5,6 |
| I_{IB}/I_{IO} | Input bias and input offset currents | vs Free-air temperature | 7 |
| V_{OH} | High-level output voltage | vs High-level output current | 8,9 |
| V_{OL} | Low-level output voltage | vs Low-level output current | 10,11 |
| $V_{O(PP)}$ | Maximum peak-to-peak output voltage | vs Frequency | 12,13 |
| I_{OS} | Short-circuit output current | vs Supply voltage | 14 |
| | | vs Free-air temperature | 15 |
| V_O | Output voltage | vs Differential input voltage | 16 |
| A_{VD} | Large-signal differential voltage amplification and phase margin | vs Frequency | 17,18 |
| A_{VD} | Differential voltage amplification | vs Load resistance | 19 |
| | | vs Free-air temperature | 20,21 |
| z_o | Output impedance | vs Frequency | 22,23 |
| CMRR | Common-mode rejection ratio | vs Frequency | 24 |
| | | vs Free-air temperature | 25 |
| k_{SVR} | Supply-voltage rejection ratio | vs Frequency | 26,27 |
| I_{DD} | Supply current (per channel) | vs Supply voltage | 28 |
| SR | Slew rate | vs Load capacitance | 29 |
| | | vs Free-air temperature | 30 |
| V_O | Voltage-follower small-signal pulse response | | 31,32 |
| V_O | Voltage-follower large-signal pulse response | | 33,34 |
| V_O | Inverting small-signal pulse response | | 35,36 |
| V_O | Inverting large-signal pulse response | | 37,38 |
| V_n | Equivalent input noise voltage | vs Frequency | 39,40 |
| | | Noise voltage (referred to input) | Over a 10-second period |
| THD + N | Total harmonic distortion plus noise | vs Frequency | 42,43 |
| | | Gain-bandwidth product | vs Supply voltage |
| B_1 | Unity-gain bandwidth | vs Load capacitance | 45 |
| ϕ_m | Phase margin | vs Load capacitance | 46 |
| | | Gain margin | vs Load capacitance |
| | Amplifier with shutdown pulse turnon/off characteristics | | 48 – 50 |
| | Supply current with shutdown pulse turnon/off characteristics | | 51 – 53 |
| | Shutdown supply current | vs Free-air temperature | 54 |
| | Shutdown forward/reverse isolation | vs Frequency | 55, 56 |

TLV277x, TLV277xA
FAMILY OF 2.7-V HIGH-SLEW-RATE RAIL-TO-RAIL OUTPUT
OPERATIONAL AMPLIFIERS WITH SHUTDOWN

SLOS209G – JANUARY 1998 – REVISED FEBRUARY 2004

TYPICAL CHARACTERISTICS

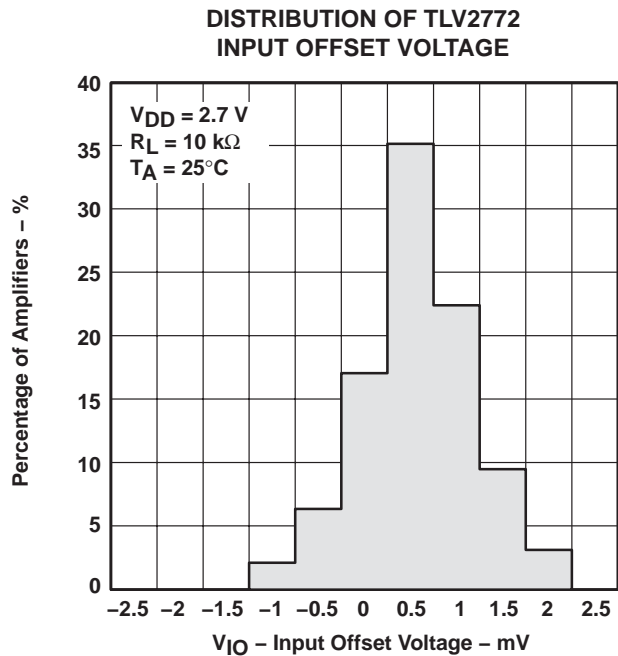

Figure 1



Figure 2

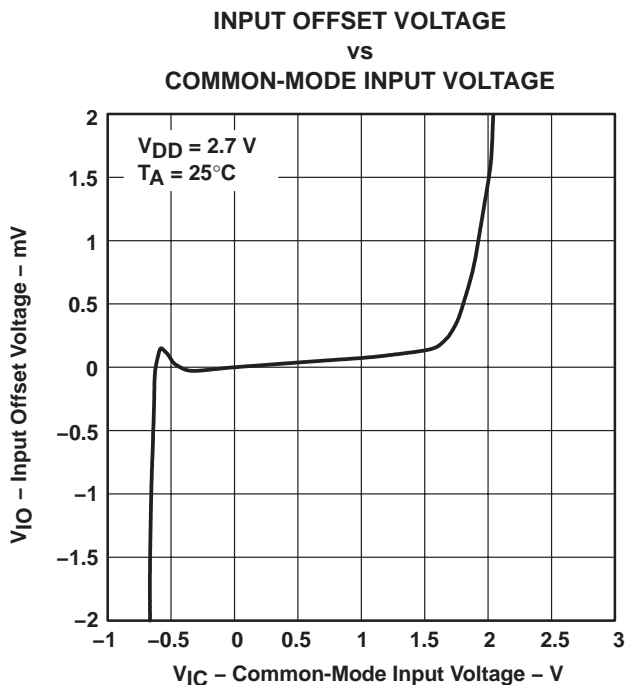

Figure 3



Figure 4

TLV277x, TLV277xA FAMILY OF 2.7-V HIGH-SLEW-RATE RAIL-TO-RAIL OUTPUT OPERATIONAL AMPLIFIERS WITH SHUTDOWN

SLOS209G – JANUARY 1998 – REVISED FEBRUARY 2004

TYPICAL CHARACTERISTICS

DISTRIBUTION OF TLV2772
INPUT OFFSET VOLTAGE

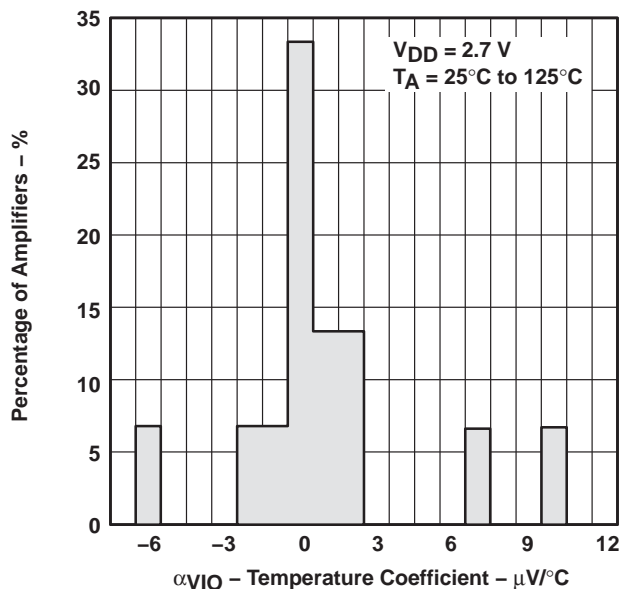

Figure 5

DISTRIBUTION OF TLV2772
INPUT OFFSET VOLTAGE

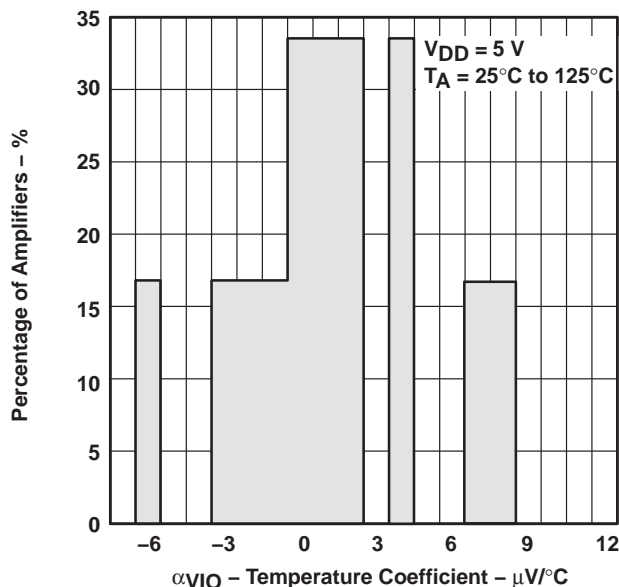

Figure 6

INPUT BIAS AND OFFSET CURRENT
vs
FREE-AIR TEMPERATURE



Figure 7

HIGH-LEVEL OUTPUT VOLTAGE
vs
HIGH-LEVEL OUTPUT CURRENT

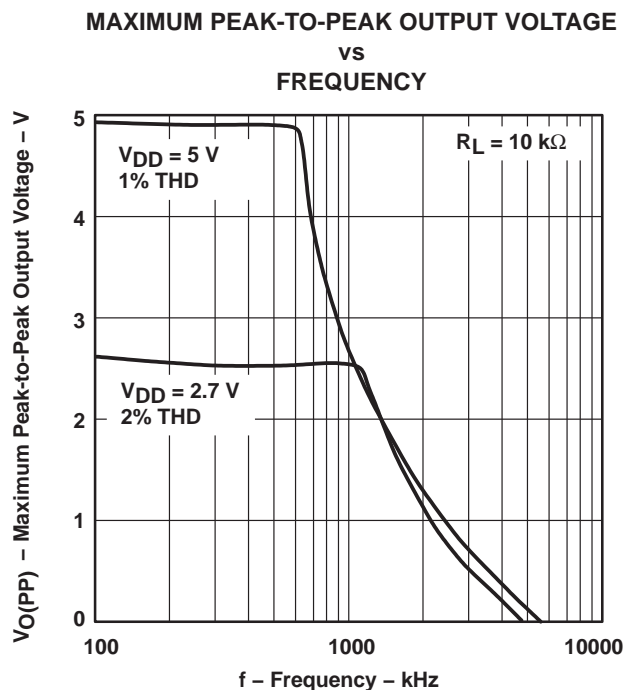
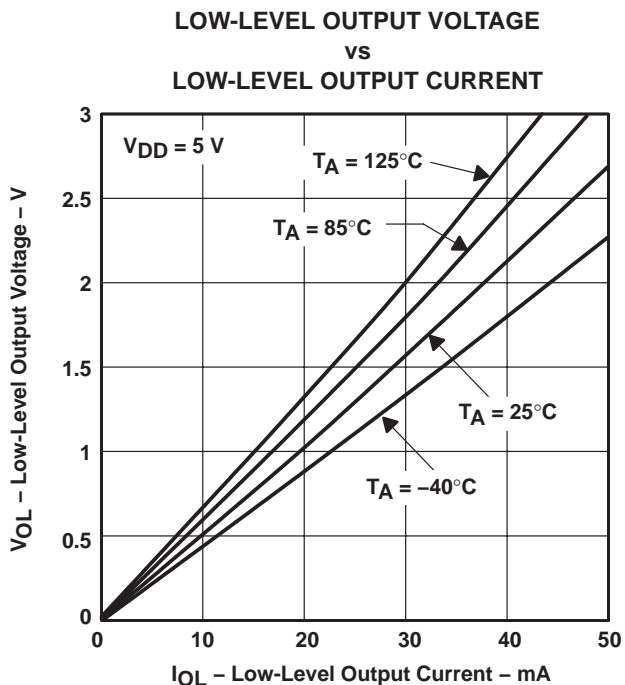
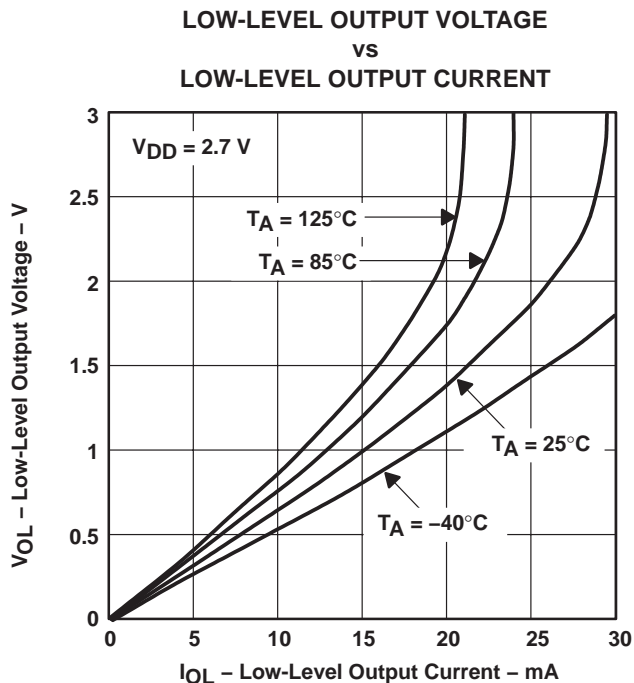
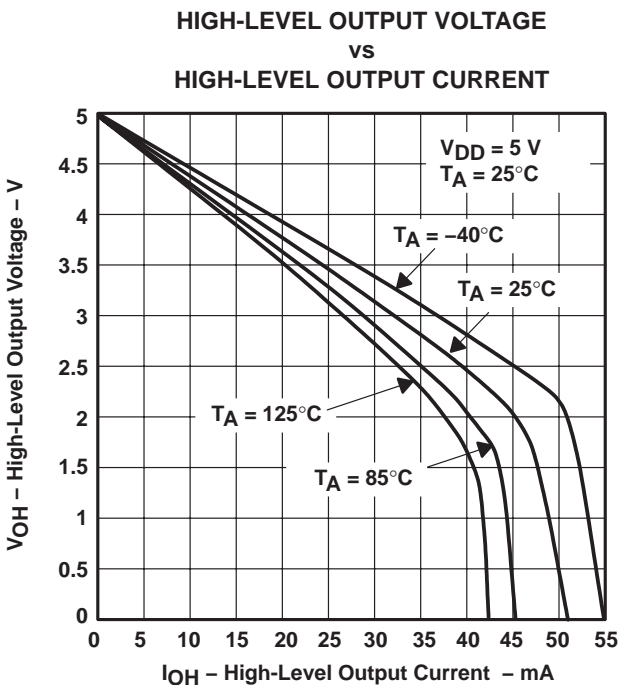

Figure 8

TLV277x, TLV277xA FAMILY OF 2.7-V HIGH-SLEW-RATE RAIL-TO-RAIL OUTPUT OPERATIONAL AMPLIFIERS WITH SHUTDOWN

SLOS209G – JANUARY 1998 – REVISED FEBRUARY 2004

TYPICAL CHARACTERISTICS



TLV277x, TLV277xA

FAMILY OF 2.7-V HIGH-SLEW-RATE RAIL-TO-RAIL OUTPUT OPERATIONAL AMPLIFIERS WITH SHUTDOWN

SLOS209G – JANUARY 1998 – REVISED FEBRUARY 2004

TYPICAL CHARACTERISTICS

MAXIMUM PEAK-TO-PEAK OUTPUT VOLTAGE
vs
FREQUENCY



Figure 13

SHORT-CIRCUIT OUTPUT CURRENT
vs
SUPPLY VOLTAGE

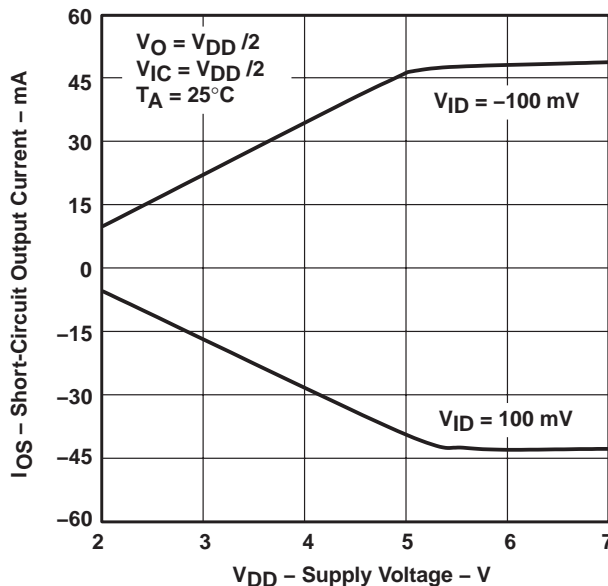

Figure 14

SHORT-CIRCUIT OUTPUT CURRENT
vs
FREE-AIR TEMPERATURE

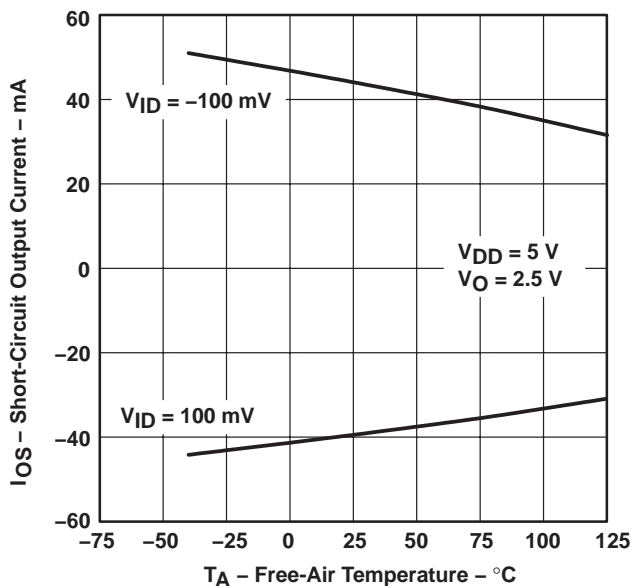

Figure 15

OUTPUT VOLTAGE
vs
DIFFERENTIAL INPUT VOLTAGE



Figure 16

TLV277x, TLV277xA
FAMILY OF 2.7-V HIGH-SLEW-RATE RAIL-TO-RAIL OUTPUT
OPERATIONAL AMPLIFIERS WITH SHUTDOWN

SLOS209G – JANUARY 1998 – REVISED FEBRUARY 2004

TYPICAL CHARACTERISTICS

LARGE-SIGNAL DIFFERENTIAL VOLTAGE AMPLIFICATION
AND PHASE MARGIN

vs
FREQUENCY

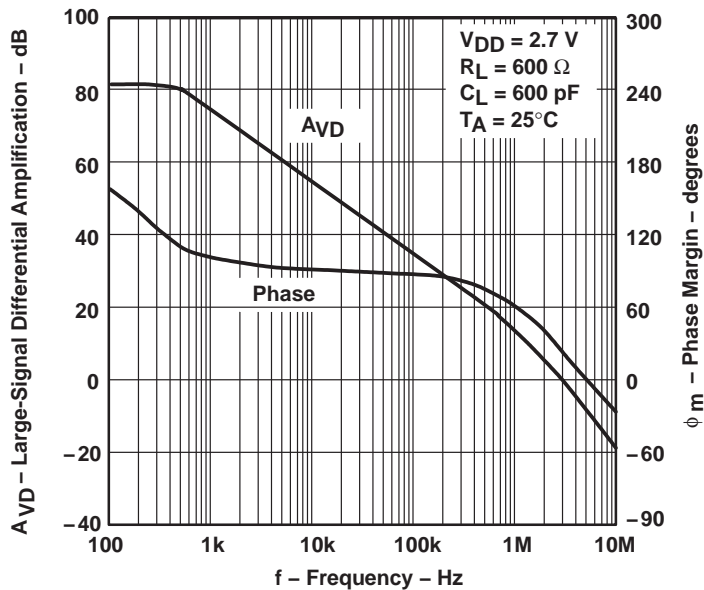

Figure 17

LARGE-SIGNAL DIFFERENTIAL VOLTAGE AMPLIFICATION
AND PHASE MARGIN

vs
FREQUENCY

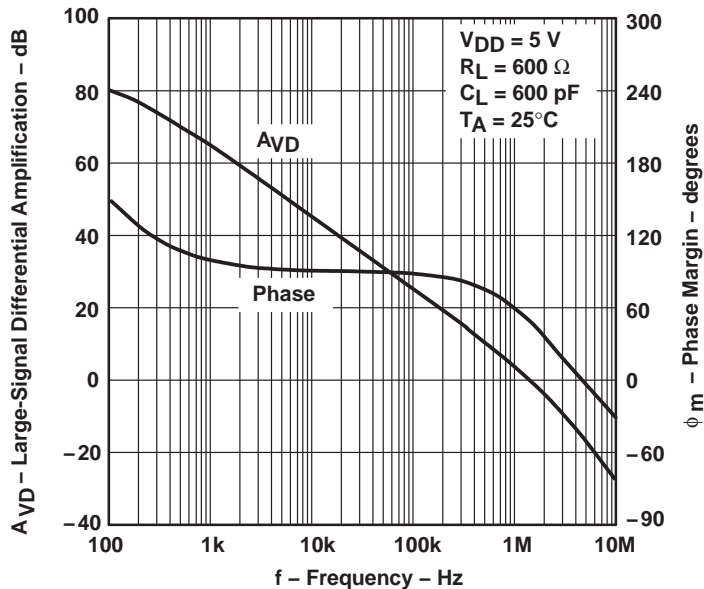

Figure 18

TLV277x, TLV277xA
FAMILY OF 2.7-V HIGH-SLEW-RATE RAIL-TO-RAIL OUTPUT
OPERATIONAL AMPLIFIERS WITH SHUTDOWN

SLOS209G – JANUARY 1998 – REVISED FEBRUARY 2004

TYPICAL CHARACTERISTICS

DIFFERENTIAL VOLTAGE AMPLIFICATION
vs
LOAD RESISTANCE



Figure 19

DIFFERENTIAL VOLTAGE AMPLIFICATION
vs
FREE-AIR TEMPERATURE

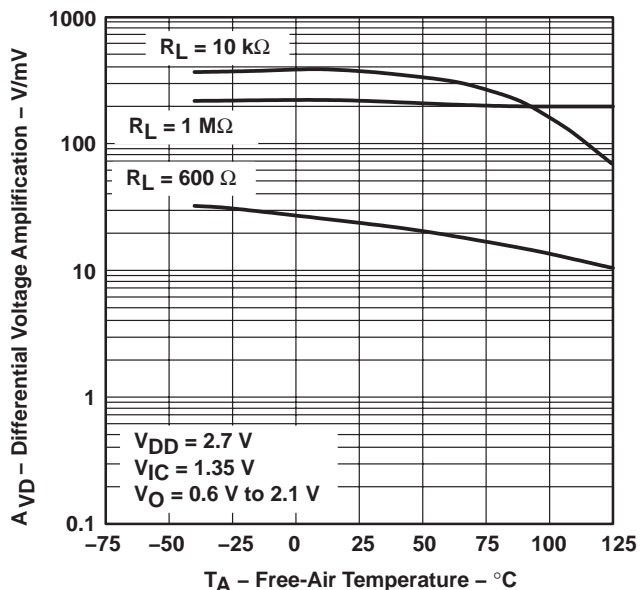

Figure 20

DIFFERENTIAL VOLTAGE AMPLIFICATION
vs
FREE-AIR TEMPERATURE

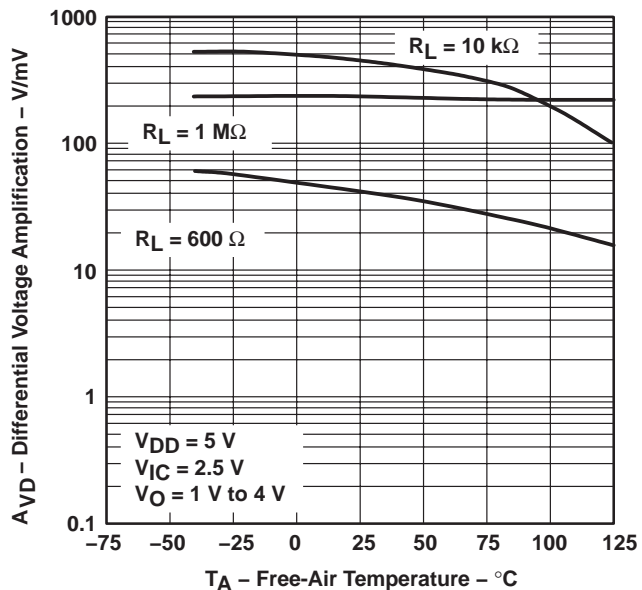

Figure 21

OUTPUT IMPEDANCE
vs
FREQUENCY

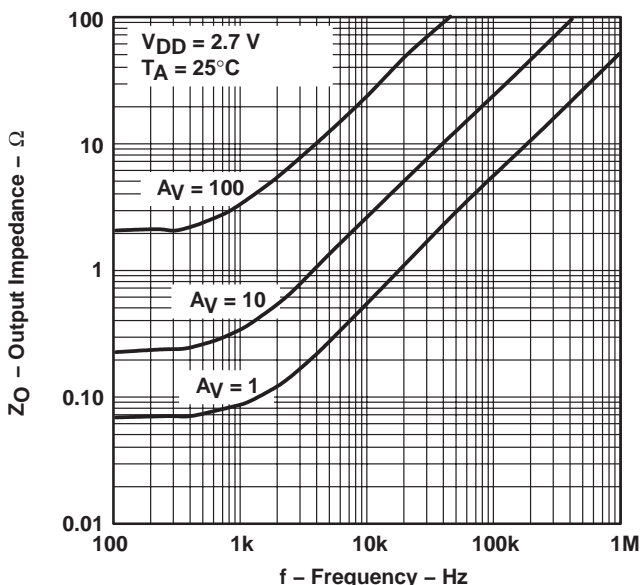

Figure 22

TLV277x, TLV277xA
FAMILY OF 2.7-V HIGH-SLEW-RATE RAIL-TO-RAIL OUTPUT
OPERATIONAL AMPLIFIERS WITH SHUTDOWN

SLOS209G – JANUARY 1998 – REVISED FEBRUARY 2004

TYPICAL CHARACTERISTICS

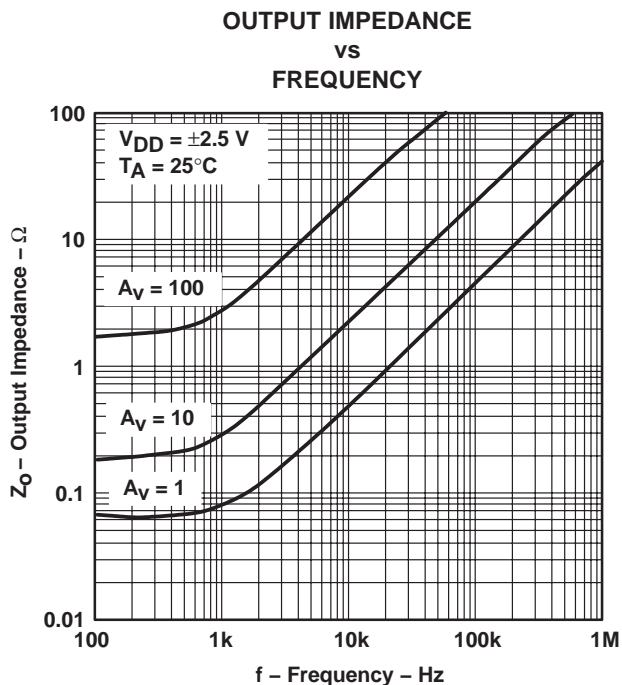

Figure 23

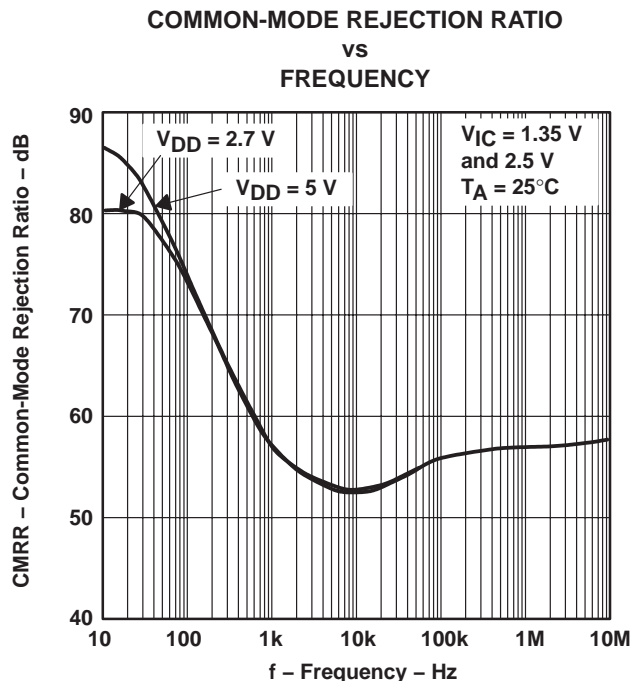

Figure 24

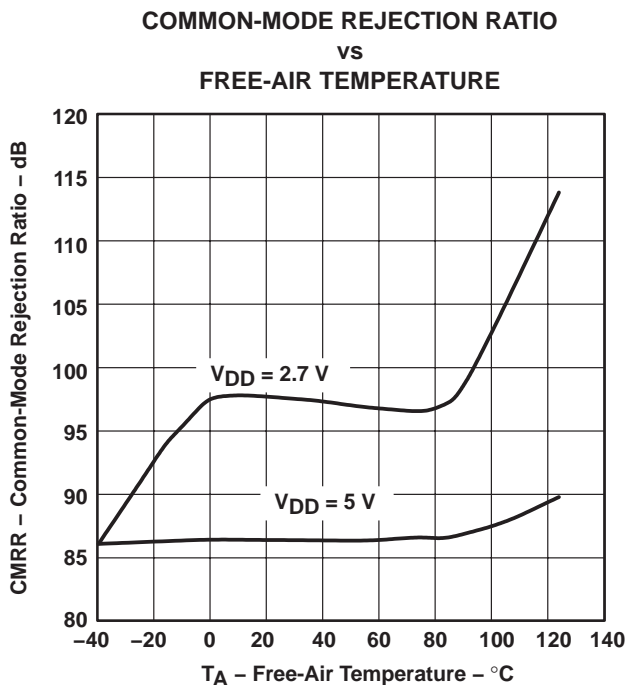

Figure 25

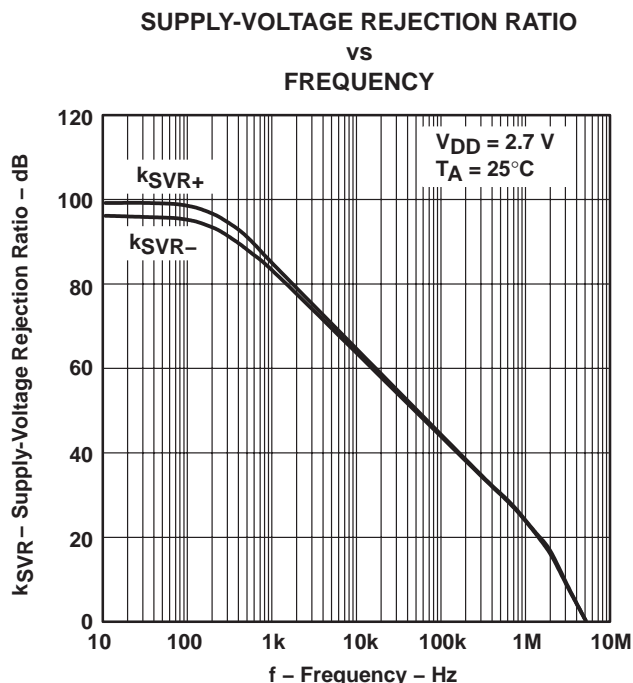

Figure 26

TLV277x, TLV277xA

FAMILY OF 2.7-V HIGH-SLEW-RATE RAIL-TO-RAIL OUTPUT OPERATIONAL AMPLIFIERS WITH SHUTDOWN

SLOS209G – JANUARY 1998 – REVISED FEBRUARY 2004

TYPICAL CHARACTERISTICS

SUPPLY VOLTAGE REJECTION RATIO
vs
FREQUENCY

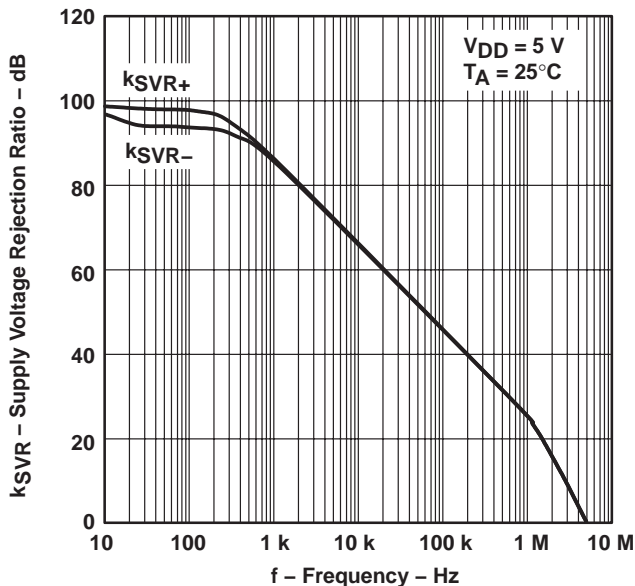

Figure 27

SUPPLY CURRENT (PER CHANNEL)
vs
SUPPLY VOLTAGE



Figure 28

SLEW RATE
vs
LOAD CAPACITANCE



Figure 29

SLEW RATE
vs
FREE-AIR TEMPERATURE

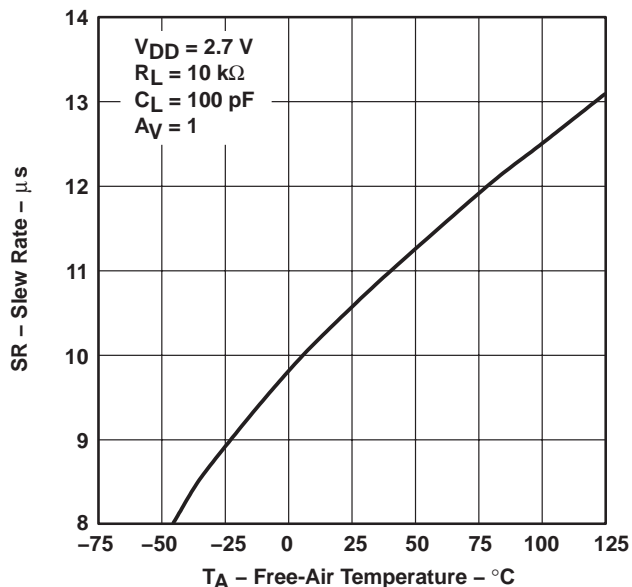

Figure 30

TLV277x, TLV277xA
FAMILY OF 2.7-V HIGH-SLEW-RATE RAIL-TO-RAIL OUTPUT
OPERATIONAL AMPLIFIERS WITH SHUTDOWN

SLOS209G – JANUARY 1998 – REVISED FEBRUARY 2004

TYPICAL CHARACTERISTICS

**VOLTAGE-FOLLOWER
SMALL-SIGNAL PULSE RESPONSE**

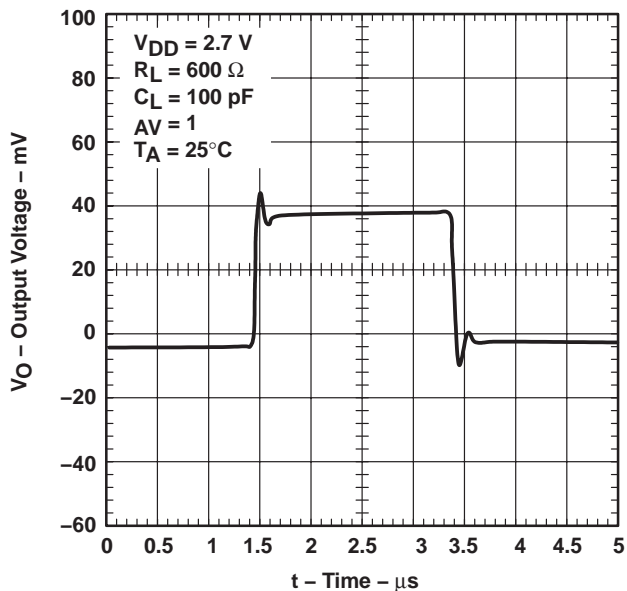

Figure 31

**VOLTAGE-FOLLOWER
SMALL-SIGNAL PULSE RESPONSE**

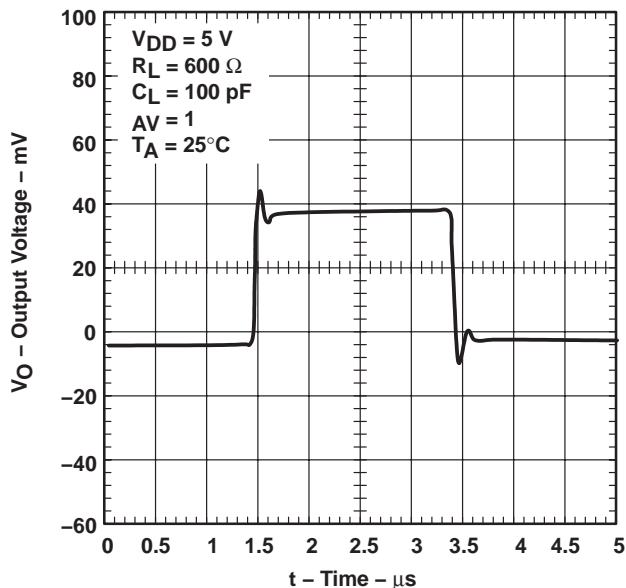

Figure 32

**VOLTAGE-FOLLOWER
LARGE-SIGNAL PULSE RESPONSE**

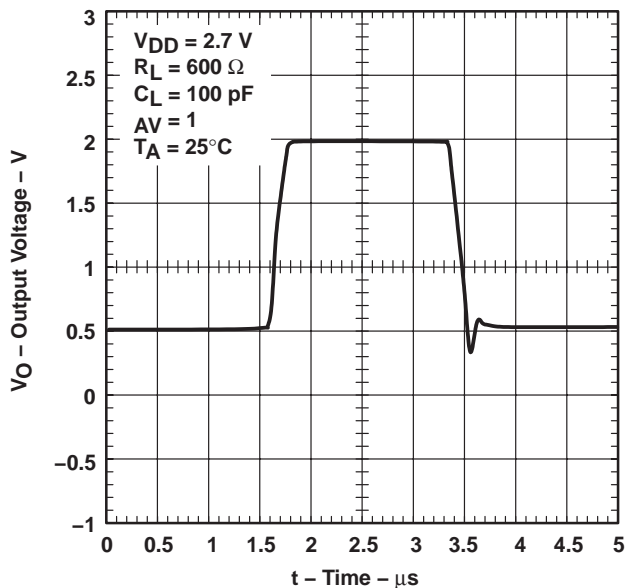

Figure 33

**VOLTAGE-FOLLOWER
LARGE-SIGNAL PULSE RESPONSE**

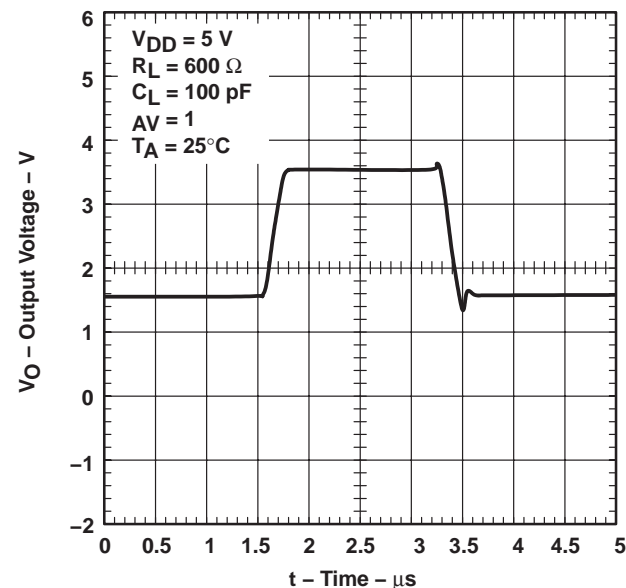

Figure 34

TLV277x, TLV277xA
FAMILY OF 2.7-V HIGH-SLEW-RATE RAIL-TO-RAIL OUTPUT
OPERATIONAL AMPLIFIERS WITH SHUTDOWN

SLOS209G – JANUARY 1998 – REVISED FEBRUARY 2004

TYPICAL CHARACTERISTICS

INVERTING SMALL-SIGNAL PULSE RESPONSE



Figure 35

INVERTING SMALL-SIGNAL PULSE RESPONSE



Figure 36

INVERTING LARGE-SIGNAL PULSE RESPONSE



Figure 37

INVERTING LARGE-SIGNAL PULSE RESPONSE

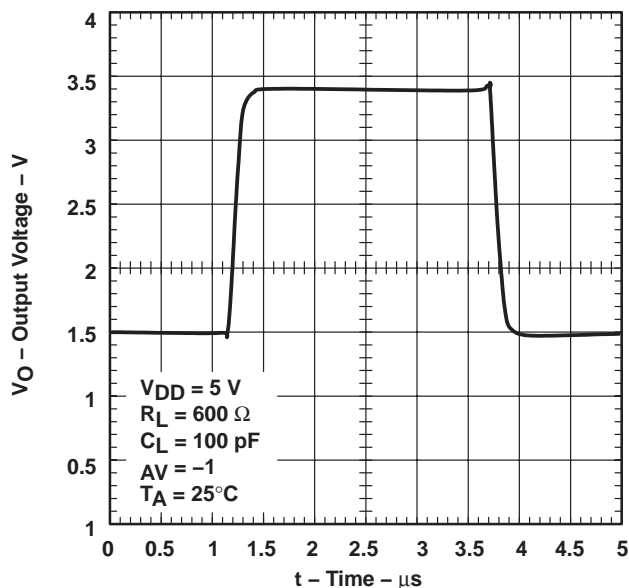

Figure 38

TLV277x, TLV277xA
FAMILY OF 2.7-V HIGH-SLEW-RATE RAIL-TO-RAIL OUTPUT
OPERATIONAL AMPLIFIERS WITH SHUTDOWN

SLOS209G – JANUARY 1998 – REVISED FEBRUARY 2004

TYPICAL CHARACTERISTICS

**EQUIVALENT INPUT NOISE VOLTAGE
vs
FREQUENCY**

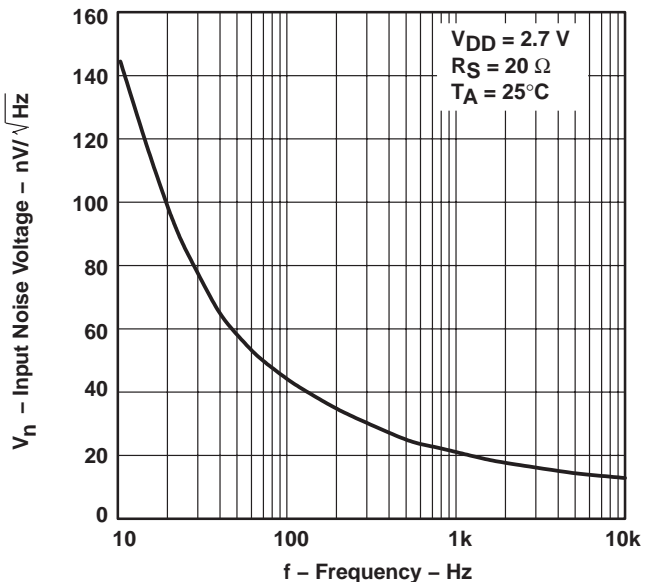

Figure 39

**EQUIVALENT INPUT NOISE VOLTAGE
vs
FREQUENCY**

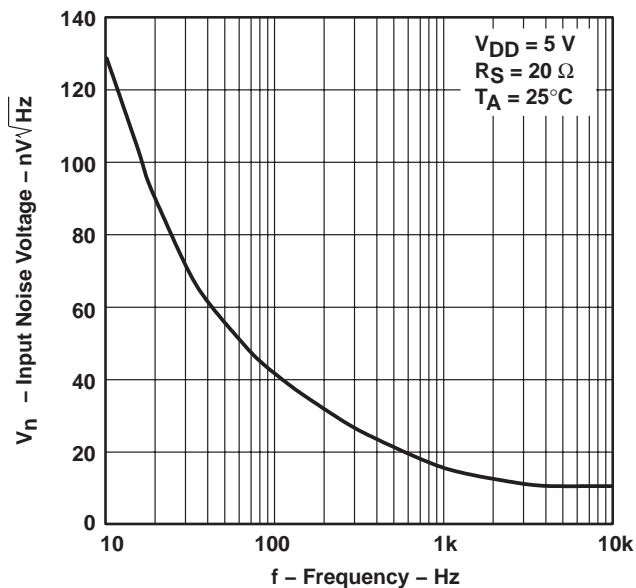

Figure 40

**NOISE VOLTAGE
OVER A 10 SECOND PERIOD**



Figure 41

TLV277x, TLV277xA
FAMILY OF 2.7-V HIGH-SLEW-RATE RAIL-TO-RAIL OUTPUT
OPERATIONAL AMPLIFIERS WITH SHUTDOWN

SLOS209G – JANUARY 1998 – REVISED FEBRUARY 2004

TYPICAL CHARACTERISTICS

TOTAL HARMONIC DISTORTION PLUS NOISE
vs
FREQUENCY



Figure 42

TOTAL HARMONIC DISTORTION PLUS NOISE
vs
FREQUENCY



Figure 43

GAIN-BANDWIDTH PRODUCT
vs
SUPPLY VOLTAGE

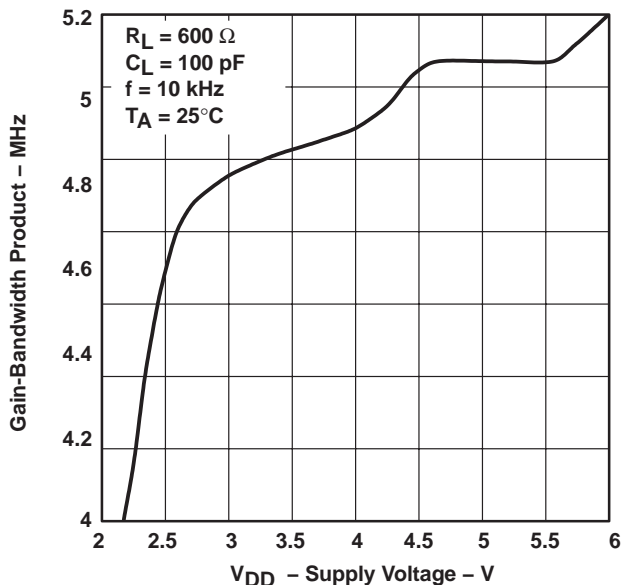

Figure 44

UNITY-GAIN BANDWIDTH
vs
LOAD CAPACITANCE



Figure 45

TLV277x, TLV277xA FAMILY OF 2.7-V HIGH-SLEW-RATE RAIL-TO-RAIL OUTPUT OPERATIONAL AMPLIFIERS WITH SHUTDOWN

SLOS209G – JANUARY 1998 – REVISED FEBRUARY 2004

TYPICAL CHARACTERISTICS



Figure 46

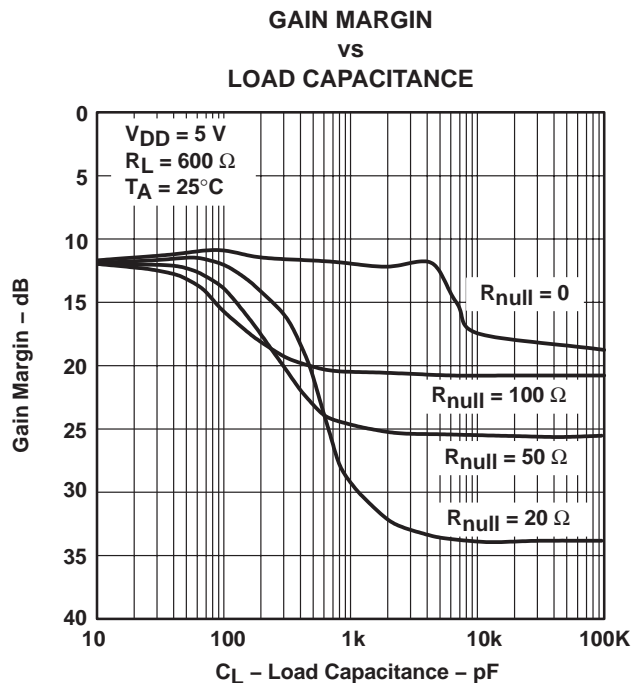

Figure 47

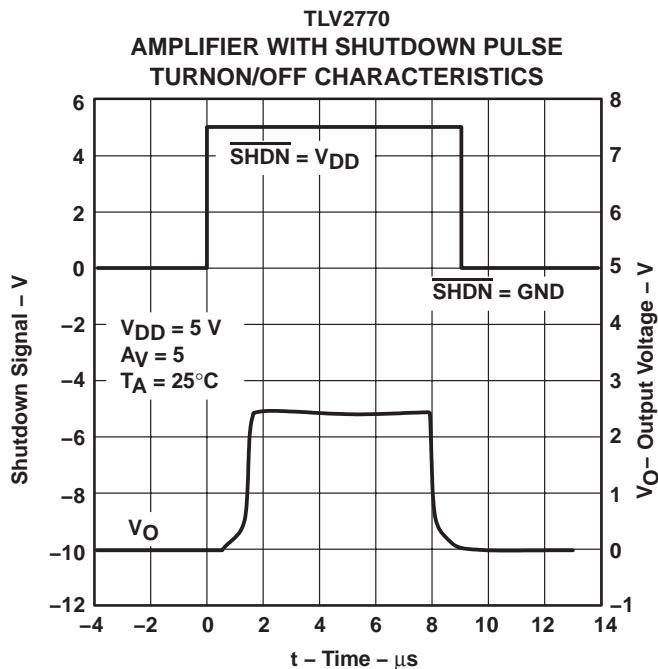

Figure 48

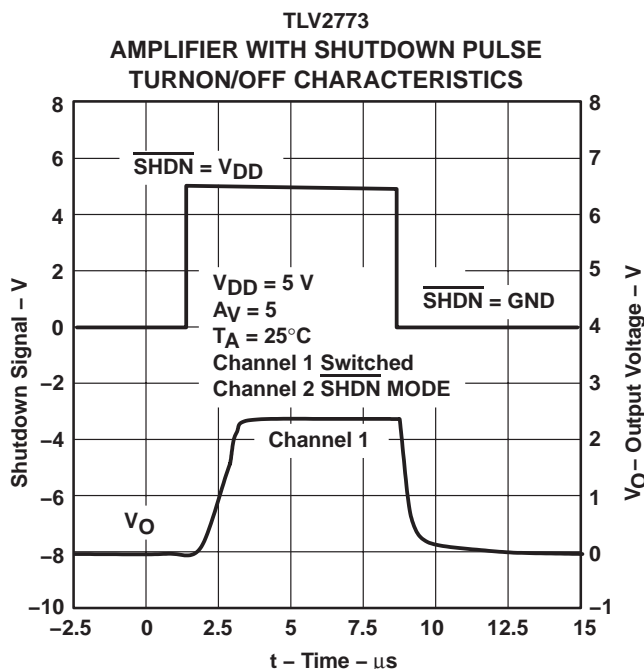

Figure 49

TLV277x, TLV277xA
FAMILY OF 2.7-V HIGH-SLEW-RATE RAIL-TO-RAIL OUTPUT
OPERATIONAL AMPLIFIERS WITH SHUTDOWN

SLOS209G – JANUARY 1998 – REVISED FEBRUARY 2004

TYPICAL CHARACTERISTICS

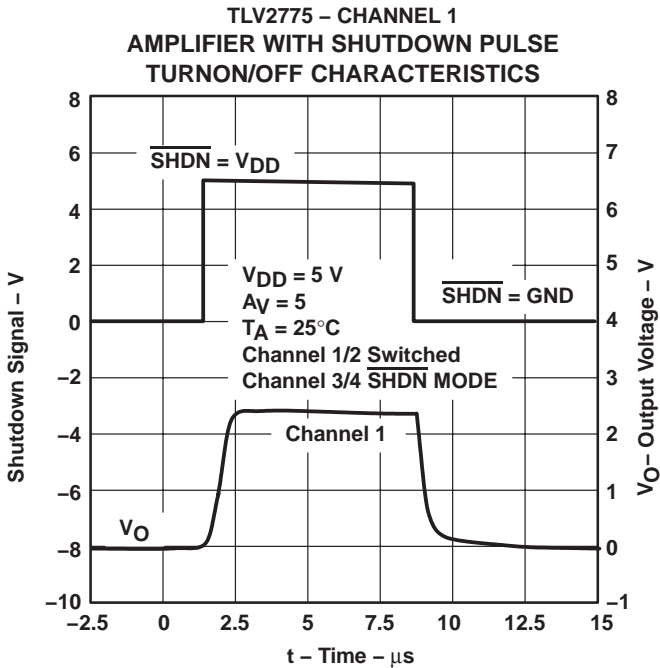

Figure 50

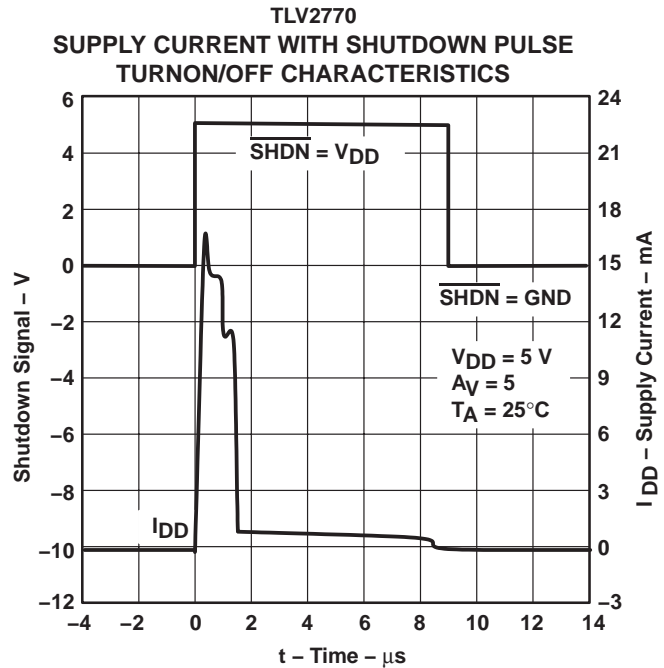

Figure 51

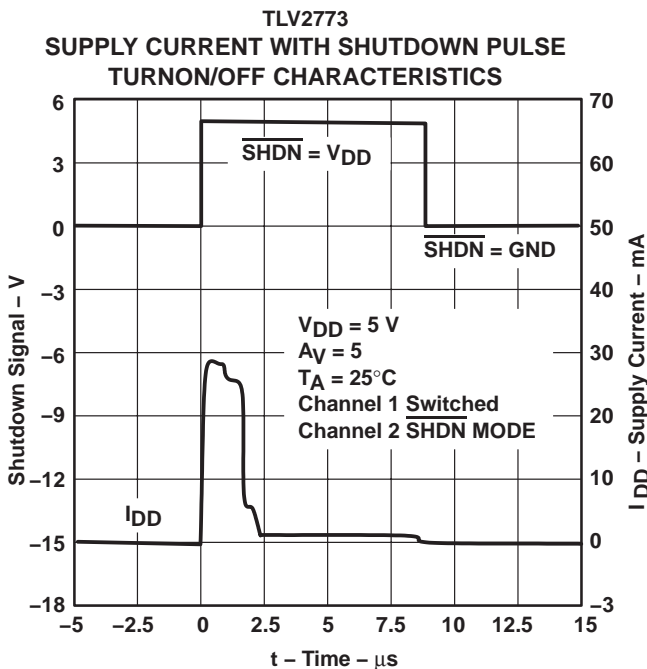

Figure 52

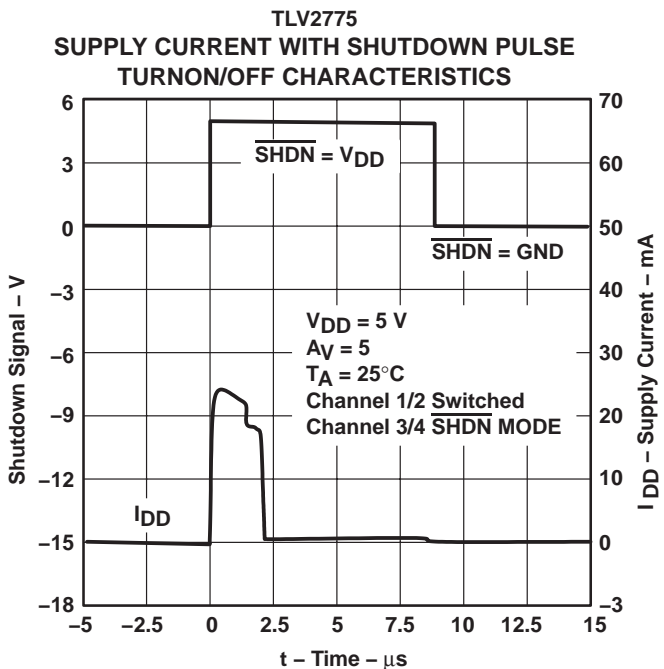

Figure 53

TLV277x, TLV277xA

FAMILY OF 2.7-V HIGH-SLEW-RATE RAIL-TO-RAIL OUTPUT OPERATIONAL AMPLIFIERS WITH SHUTDOWN

SLOS209G – JANUARY 1998 – REVISED FEBRUARY 2004

TYPICAL CHARACTERISTICS

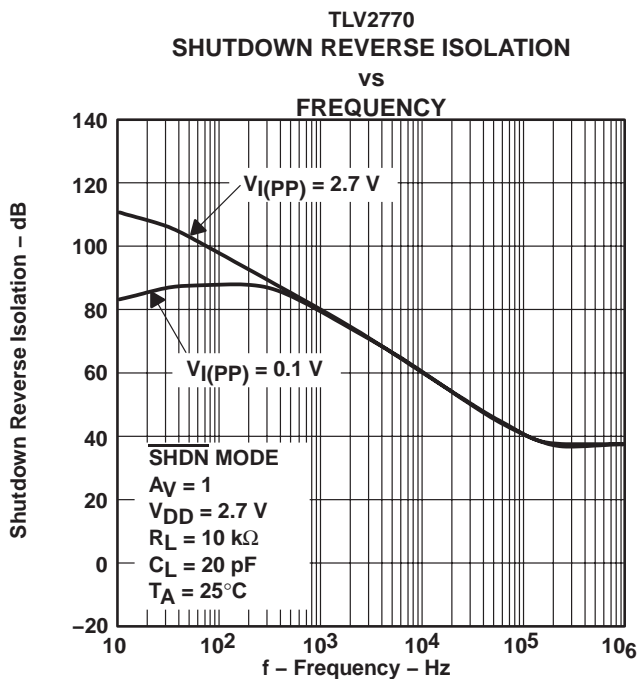
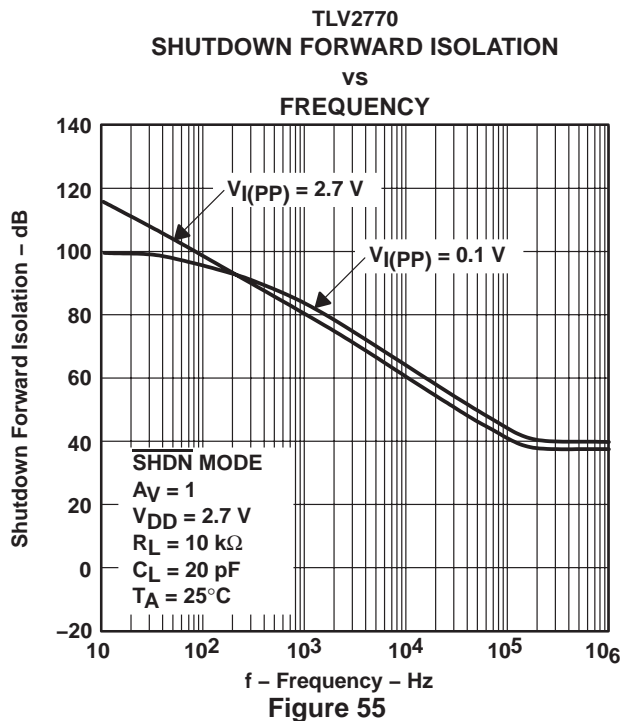

TLV277x, TLV277xA FAMILY OF 2.7-V HIGH-SLEW-RATE RAIL-TO-RAIL OUTPUT OPERATIONAL AMPLIFIERS WITH SHUTDOWN

SLOS209G – JANUARY 1998 – REVISED FEBRUARY 2004

PARAMETER MEASUREMENT INFORMATION

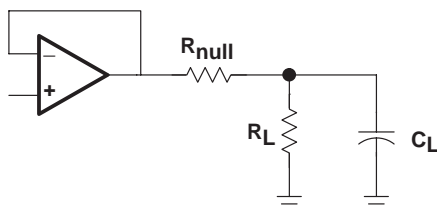

Figure 57

driving a capacitive load

When the amplifier is configured in this manner, capacitive loading directly on the output will decrease the device's phase margin leading to high frequency ringing or oscillations. Therefore, for capacitive loads of greater than 10 pF, it is recommended that a resistor be placed in series (R_{NULL}) with the output of the amplifier, as shown in Figure 58. A minimum value of 20 Ω should work well for most applications.

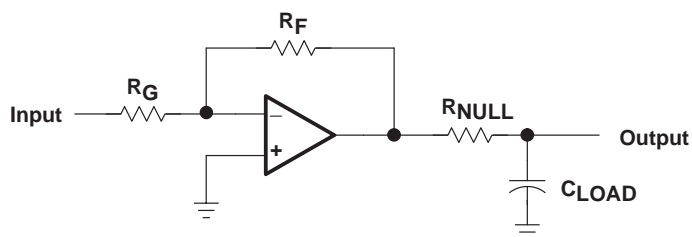

Figure 58. Driving a Capacitive Load

APPLICATION INFORMATION

offset voltage

The output offset voltage, (V_{OO}) is the sum of the input offset voltage (V_{IO}) and both input bias currents (I_{IB}) times the corresponding gains. The following schematic and formula can be used to calculate the output offset voltage:

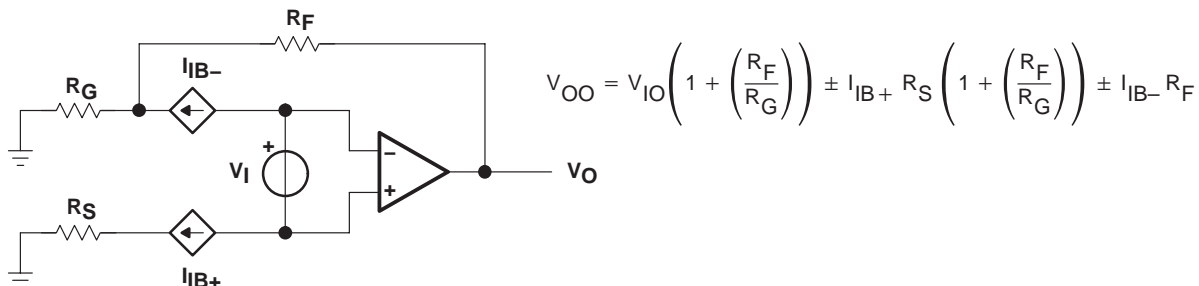

Figure 59. Output Offset Voltage Model

general configurations

When receiving low-level signals, limiting the bandwidth of the incoming signals into the system is often required. The simplest way to accomplish this is to place an RC filter at the noninverting terminal of the amplifier (see Figure 60).

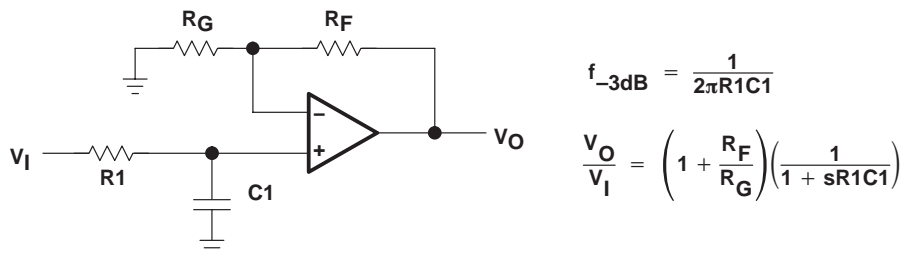

Figure 60. Single-Pole Low-Pass Filter

If even more attenuation is needed, a multiple pole filter is required. The Sallen-Key filter can be used for this task. For best results, the amplifier should have a bandwidth that is 8 to 10 times the filter frequency bandwidth. Failure to do this can result in phase shift of the amplifier.

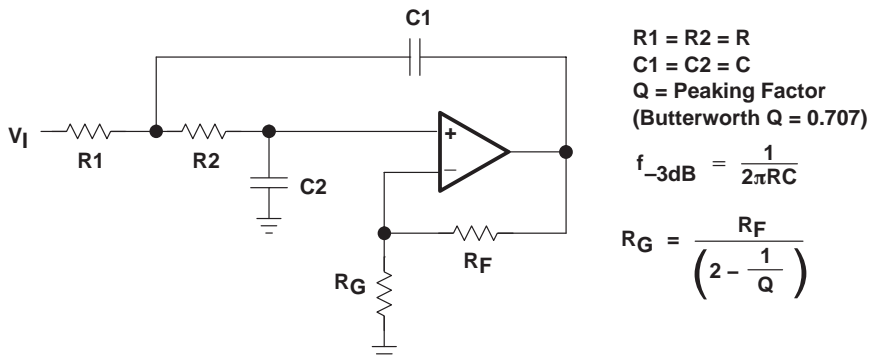

Figure 61. 2-Pole Low-Pass Sallen-Key Filter

TLV277x, TLV277xA FAMILY OF 2.7-V HIGH-SLEW-RATE RAIL-TO-RAIL OUTPUT OPERATIONAL AMPLIFIERS WITH SHUTDOWN

SLOS209G – JANUARY 1998 – REVISED FEBRUARY 2004

APPLICATION INFORMATION

using the TLV2772 as an accelerometer interface

The schematic, shown in Figure 62, shows the ACH04-08-05 interfaced to the TLV1544 10-bit analog-to-digital converter (ADC).

The ACH04-08-05 is a shock sensor designed to convert mechanical acceleration into electrical signals. The sensor contains three piezoelectric sensing elements oriented to simultaneously measure acceleration in three orthogonal, linear axes (x, y, z). The operating frequency is 0.5 Hz to 5 kHz. The output is buffered with an internal JFET and has a typical output voltage of 1.80 mV/g for the x and y axis and 1.35 mV/g for the z axis.

Amplification and frequency shaping of the shock sensor output is done by the TLV2772 rail-to-rail operational amplifier. The TLV2772 is ideal for this application as it offers high input impedance, good slew rate, and excellent dc precision. The rail-to-rail output swing and high output drive are perfect for driving the analog input of the TLV1544 ADC.



Figure 62. Accelerometer Interface Schematic

The sensor signal must be amplified and frequency-shaped to provide a signal the ADC can properly convert into the digital domain. Figure 62 shows the topology used in this application for one axis of the sensor. This system is powered from a single 3-V supply. Configuring the TLV431 with a 2.2-kΩ resistor produces a reference voltage of 1.23 V. This voltage is used to bias the operational amplifier and the internal JFETs in the shock sensor.

APPLICATION INFORMATION

gain calculation

Since the TLV2772 is capable of rail-to-rail output using a 3-V supply, $V_O = 0$ (min) to 3 V (max). With no signal from the sensor, nominal $V_O =$ reference voltage = 1.23 V. Therefore, the maximum negative swing from nominal is $0\text{ V} - 1.23\text{ V} = -1.23\text{ V}$ and the maximum positive swing is $3\text{ V} - 1.23\text{ V} = 1.77\text{ V}$. By modeling the shock sensor as a low impedance voltage source with output of 2.25 mV/g (max) in the x and y axis and 1.70 mV/g (max) in the z axis, the gain of the circuit is calculated by equation 1.

$$\text{Gain} = \frac{\text{Output Swing}}{\text{Sensor Signal} \times \text{Acceleration}} \quad (1)$$

To avoid saturation of the operational amplifier, the gain calculations are based on the maximum negative swing of -1.23 V and the maximum sensor output of 2.25 mV/g (x and y axis) and 1.70 mV/g (z axis).

$$\text{Gain (x, y)} = \frac{-1.23\text{ V}}{2.25\text{ mV/g} \times -50\text{ g}} = 10.9 \quad (2)$$

and

$$\text{Gain (z)} = \frac{-1.23\text{ V}}{1.70\text{ mV/g} \times -50\text{ g}} = 14.5 \quad (3)$$

By selecting $R_3 = 10\text{ k}\Omega$ and $R_4 = 100\text{ k}\Omega$, in the x and y channels, a gain of 11 is realized. By selecting $R_3 = 7.5\text{ k}\Omega$ and $R_4 = 100\text{ k}\Omega$, in the z channel, a gain of 14.3 is realized. The schematic shows the configuration for either the x- or y-axis.

bandwidth calculation

To calculate the component values for the frequency shaping characteristics of the signal conditioning circuit, 1 Hz and 500 Hz are selected as the minimum required 3-dB bandwidth.

To minimize the value of the input capacitor (C1) required to set the lower cutoff frequency requires a large value resistor for R2 is required. A 1-M Ω resistor is used in this example. To set the lower cutoff frequency, the required capacitor value for C1 is:

$$C1 = \frac{1}{2\pi f_{\text{LOW}} R_2} = 0.159\text{ }\mu\text{F} \quad (4)$$

Using a value of 0.22 μF , a more common value of capacitor, the lower cutoff frequency is 0.724 Hz.

To minimize the phase shift in the feedback loop caused by the input capacitance of the TLV2772, it is best to minimize the value of the feedback resistor R4. However, to reduce the required capacitance in the feedback loop a large value for R4 is required. Therefore, a compromise for the value of R4 must be made. In this circuit, a value of 100 k Ω has been selected. To set the upper cutoff frequency, the required capacitor value for C2 is:

$$C2 = \frac{1}{2\pi f_{\text{HIGH}} R_4} = 3.18\text{ }\mu\text{F} \quad (5)$$

Using a 2.2-nF capacitor, the upper cutoff frequency is 724 Hz.

R5 and C3 also cause the signal response to roll off. Therefore, it is beneficial to design this roll-off point to begin at the upper cutoff frequency. Assuming a value of 1 k Ω for R5, the value for C3 is calculated to be 0.22 μF .

TLV277x, TLV277xA

FAMILY OF 2.7-V HIGH-SLEW-RATE RAIL-TO-RAIL OUTPUT OPERATIONAL AMPLIFIERS WITH SHUTDOWN

SLOS209G – JANUARY 1998 – REVISED FEBRUARY 2004

APPLICATION INFORMATION

circuit layout considerations

To achieve the levels of high performance of the TLV277x, follow proper printed-circuit board design techniques. A general set of guidelines is given in the following.

- Ground planes—It is highly recommended that a ground plane be used on the board to provide all components with a low inductive ground connection. However, in the areas of the amplifier inputs and output, the ground plane can be removed to minimize the stray capacitance.
- Proper power supply decoupling—Use a 6.8- μ F tantalum capacitor in parallel with a 0.1- μ F ceramic capacitor on each supply terminal. It may be possible to share the tantalum among several amplifiers depending on the application, but a 0.1- μ F ceramic capacitor should always be used on the supply terminal of every amplifier. In addition, the 0.1- μ F capacitor should be placed as close as possible to the supply terminal. As this distance increases, the inductance in the connecting trace makes the capacitor less effective. The designer should strive for distances of less than 0.1 inches between the device power terminals and the ceramic capacitors.
- Sockets—Sockets can be used but are not recommended. The additional lead inductance in the socket pins will often lead to stability problems. Surface-mount packages soldered directly to the printed-circuit board is the best implementation.
- Short trace runs/compact part placements—Optimum high performance is achieved when stray series inductance has been minimized. To realize this, the circuit layout should be made as compact as possible, thereby minimizing the length of all trace runs. Particular attention should be paid to the inverting input of the amplifier. Its length should be kept as short as possible. This will help to minimize stray capacitance at the input of the amplifier.
- Surface-mount passive components—Using surface-mount passive components is recommended for high performance amplifier circuits for several reasons. First, because of the extremely low lead inductance of surface-mount components, the problem with stray series inductance is greatly reduced. Second, the small size of surface-mount components naturally leads to a more compact layout thereby minimizing both stray inductance and capacitance. If leaded components are used, it is recommended that the lead lengths be kept as short as possible.

APPLICATION INFORMATION

general power dissipation considerations

For a given θ_{JA} , the maximum power dissipation is shown in Figure 63 and is calculated by the following formula:

$$P_D = \left(\frac{T_{MAX} - T_A}{\theta_{JA}} \right)$$

Where:

- P_D = Maximum power dissipation of TLV277x IC (watts)
- T_{MAX} = Absolute maximum junction temperature (150°C)
- T_A = Free-ambient air temperature (°C)
- $\theta_{JA} = \theta_{JC} + \theta_{CA}$
- θ_{JC} = Thermal coefficient from junction to case
- θ_{CA} = Thermal coefficient from case to ambient air (°C/W)

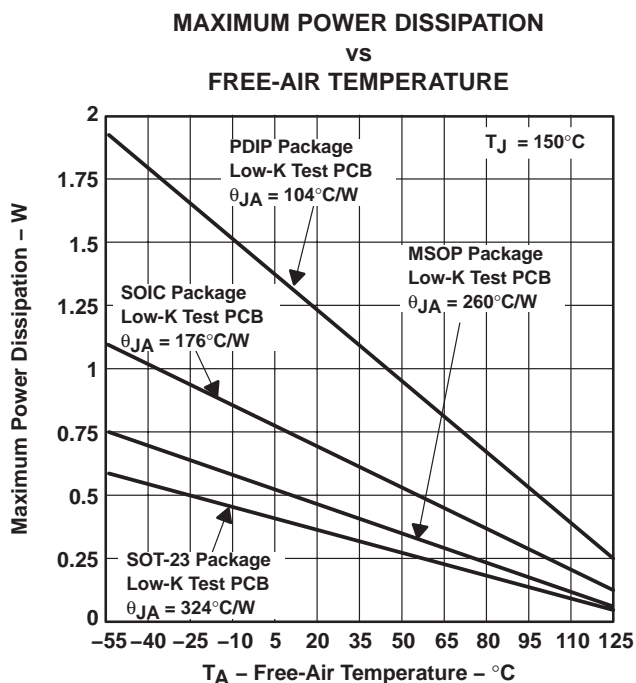

NOTE A: Results are with no air flow and using JEDEC Standard Low-K test PCB.

Figure 63. Maximum Power Dissipation vs Free-Air Temperature

TLV277x, TLV277xA

FAMILY OF 2.7-V HIGH-SLEW-RATE RAIL-TO-RAIL OUTPUT OPERATIONAL AMPLIFIERS WITH SHUTDOWN

SLOS209G – JANUARY 1998 – REVISED FEBRUARY 2004

APPLICATION INFORMATION

shutdown function

Three members of the TLV277x family (TLV2770/3/5) have a shutdown terminal for conserving battery life in portable applications. When the shutdown terminal is tied low, the supply current is reduced to $0.8 \mu\text{A}/\text{channel}$, the amplifier is disabled, and the outputs are placed in a high impedance mode. To enable the amplifier, the shutdown terminal can either be left floating or pulled high. When the shutdown terminal is left floating, care needs to be taken to ensure that parasitic leakage current at the shutdown terminal does not inadvertently place the operational amplifier into shutdown. The shutdown terminal threshold is always referenced to $V_{DD}/2$. Therefore, when operating the device with split supply voltages (e.g. $\pm 2.5 \text{ V}$), the shutdown terminal needs to be pulled to V_{DD-} (not GND) to disable the operational amplifier.

The amplifier's output with a shutdown pulse is shown in Figures 48, 49, and 50. The amplifier is powered with a single 5-V supply and configured as a noninverting configuration with a gain of 5. The amplifier turnon and turnoff times are measured from the 50% point of the shutdown pulse to the 50% point of the output waveform. The times for the single, dual, and quad are listed in the data tables. The *bump* on the rising edge of the TLV2770 output waveform is due to the start-up circuit on the bias generator. For the dual and quad (TLV2773/5), this *bump* is attributed to the bias generator's start-up circuit as well as the crosstalk between the other channel(s), which are in shutdown.

Figures 55 and 56 show the amplifier's forward and reverse isolation in shutdown. The operational amplifier is powered by $\pm 1.35\text{-V}$ supplies and configured as a voltage follower ($A_V = 1$). The isolation performance is plotted across frequency for both 0.1 V_{PP} and 2.7 V_{PP} input signals. During normal operation, the amplifier would not be able to handle a 2.7-V_{PP} input signal with a supply voltage of $\pm 1.35 \text{ V}$ since it exceeds the common-mode input voltage range (V_{ICR}). However, this curve illustrates that the amplifier remains in shutdown even under a worst case scenario.

TLV277x, TLV277xA

FAMILY OF 2.7-V HIGH-SLEW-RATE RAIL-TO-RAIL OUTPUT OPERATIONAL AMPLIFIERS WITH SHUTDOWN

SLOS209G – JANUARY 1998 – REVISED FEBRUARY 2004

APPLICATION INFORMATION

macromodel information

Macromodel information provided was derived using Microsim *Parts*™ Release 8, the model generation software used with Microsim *PSpice*™. The Boyle macromodel (see Note 4) and subcircuit in Figure 64 are generated using the TLV2772 typical electrical and operating characteristics at $T_A = 25^\circ\text{C}$. Using this information, output simulations of the following key parameters can be generated to a tolerance of 20% (in most cases):

- Maximum positive output voltage swing
- Maximum negative output voltage swing
- Slew rate
- Quiescent power dissipation
- Input bias current
- Open-loop voltage amplification
- Unity-gain frequency
- Common-mode rejection ratio
- Phase margin
- DC output resistance
- AC output resistance
- Short-circuit output current limit

NOTE 4: G. R. Boyle, B. M. Cohn, D. O. Pederson, and J. E. Solomon, "Macromodeling of Integrated Circuit Operational Amplifiers", *IEEE Journal of Solid-State Circuits*, SC-9, 353 (1974).

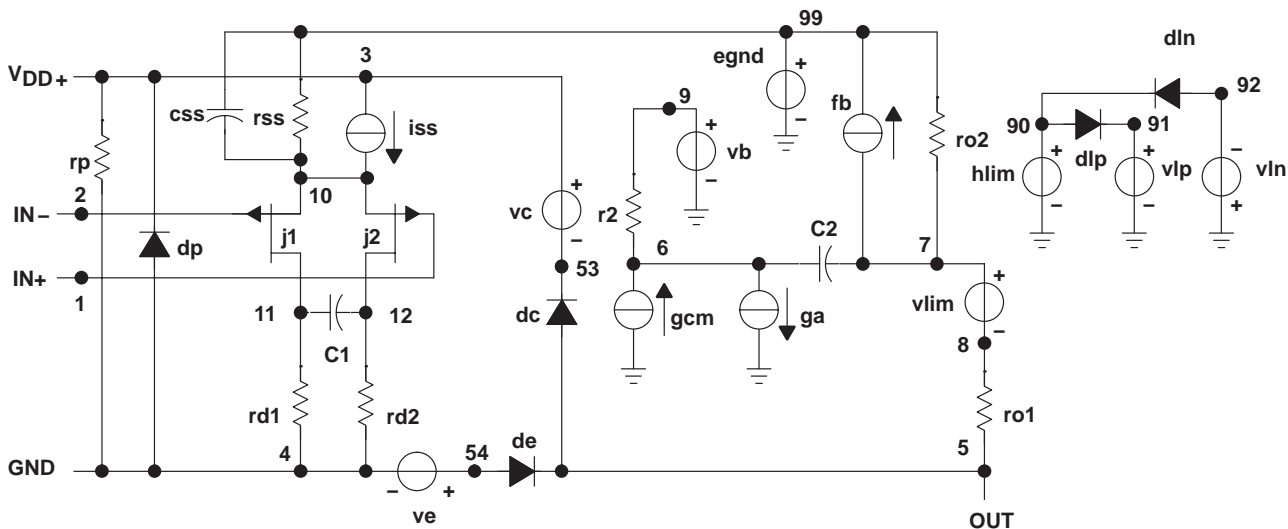

* TLV2772 operational amplifier macromodel subcircuit
 * created using Parts release 8.0 on 12/12/97 at 10:08
 * Parts is a MicroSim product.

* connections: noninverting input
 * |
 * | inverting input
 * | | positive power supply
 * | | | negative power supply
 * | | | | output
 * | | | | |

.subckt TLV2772

```

1 2 3 4 5
*
c1      11 12  2.8868E-12
c2      6  7  10.000E-12
css     10 99  2.6302E-12
dc      5  53 dy
de      54 5  dy
dlp     90 91 dx
dln     92 90 dx
dp      4  3  dx
egnd    99 0  poly(2) (3,0) (4,0) 0 .5 .5
fb      7  99 poly(5) vb vc ve vlp vln 0
        15.513E6 -1E3 1E3 16E6 -16E6
ga      6  0  11 12 188.50E-6
gcm     0  6  10 99 9.4472E-9
    
```

```

iss      3 10  dc 145.50E-6
hlim     90 0  vlim 1K
j1       11 2  10 jx1
j2       12 1  10 jx2
r2       6  9  100.00E3
rd1      4 11  5.3052E3
rd2      4 12  5.3052E3
ro1      8  5  17.140
ro2      7 99  17.140
rp       3  4  4.5455E3
rss      10 99  1.3746E6
vb       9  0  dc 0
vc       3 53  dc .82001
ve       54 4  dc .82001
vlim     7  8  dc 0
vlp     91 0  dc 47
vln     92 0  dc 47
.model  dx D(Is=800.00E-18)
.model  dy D(Is=800.00E-18 Rs=1m Cjo=10p)
.model  jx1 PjF(Is=2.2500E-12 Beta=244.20E-6
              + Vto=-.99765)
.model  jx2 PjF(Is=1.7500E-12 Beta=244.20E-6
              + Vto=-1.002350)
.ends
    
```

*\$

Figure 64. Boyle Macromodel and Subcircuit

PSpice and *Parts* are trademarks of MicroSim Corporation.

PACKAGING INFORMATION

| Orderable Device | Status (1) | Package Type | Package Drawing | Pins | Package Qty | Eco Plan (2) | Lead/Ball Finish (6) | MSL Peak Temp (3) | Op Temp (°C) | Device Marking (4/5) | Samples |
|------------------|---------------|--------------|-----------------|------|-------------|----------------------------|-------------------------|----------------------|--------------|-------------------------|-------------------------|
| 5962-9858802QPA | ACTIVE | CDIP | JG | 8 | 1 | TBD | A42 | N / A for Pkg Type | -55 to 125 | 9858802QPA TLV2772AM | Samples |
| TLV2770AID | ACTIVE | SOIC | D | 8 | 75 | Green (RoHS & no Sb/Br) | CU NIPDAU | Level-1-260C-UNLIM | -40 to 125 | 2770AI | Samples |
| TLV2770AIP | ACTIVE | PDIP | P | 8 | 50 | Green (RoHS & no Sb/Br) | CU NIPDAU | N / A for Pkg Type | -40 to 125 | TLV2770AI | Samples |
| TLV2770CD | ACTIVE | SOIC | D | 8 | 75 | Green (RoHS & no Sb/Br) | CU NIPDAU | Level-1-260C-UNLIM | 0 to 70 | 2770C | Samples |
| TLV2770CDR | ACTIVE | SOIC | D | 8 | 2500 | Green (RoHS & no Sb/Br) | CU NIPDAU | Level-1-260C-UNLIM | 0 to 70 | 2770C | Samples |
| TLV2770CP | ACTIVE | PDIP | P | 8 | 50 | Green (RoHS & no Sb/Br) | CU NIPDAU | N / A for Pkg Type | 0 to 70 | TLV2770C | Samples |
| TLV2770IDGKR | ACTIVE | VSSOP | DGK | 8 | 2500 | Green (RoHS & no Sb/Br) | CU NIPDAU | Level-1-260C-UNLIM | -40 to 125 | ABP | Samples |
| TLV2770IDR | ACTIVE | SOIC | D | 8 | 2500 | Green (RoHS & no Sb/Br) | CU NIPDAU | Level-1-260C-UNLIM | -40 to 125 | 2770I | Samples |
| TLV2770IP | ACTIVE | PDIP | P | 8 | 50 | Green (RoHS & no Sb/Br) | CU NIPDAU | N / A for Pkg Type | -40 to 125 | TLV2770I | Samples |
| TLV2771AIDR | ACTIVE | SOIC | D | 8 | 2500 | Green (RoHS & no Sb/Br) | CU NIPDAU | Level-1-260C-UNLIM | -40 to 125 | 2771AI | Samples |
| TLV2771CD | ACTIVE | SOIC | D | 8 | 75 | Green (RoHS & no Sb/Br) | CU NIPDAU | Level-1-260C-UNLIM | 0 to 70 | 2771C | Samples |
| TLV2771CDBVR | ACTIVE | SOT-23 | DBV | 5 | 3000 | Green (RoHS & no Sb/Br) | CU NIPDAU | Level-1-260C-UNLIM | 0 to 70 | VAMC | Samples |
| TLV2771CDBVRG4 | ACTIVE | SOT-23 | DBV | 5 | 3000 | Green (RoHS & no Sb/Br) | CU NIPDAU | Level-1-260C-UNLIM | 0 to 70 | VAMC | Samples |
| TLV2771CDBVT | ACTIVE | SOT-23 | DBV | 5 | 250 | Green (RoHS & no Sb/Br) | CU NIPDAU | Level-1-260C-UNLIM | 0 to 70 | VAMC | Samples |
| TLV2771CDR | ACTIVE | SOIC | D | 8 | 2500 | Green (RoHS & no Sb/Br) | CU NIPDAU | Level-1-260C-UNLIM | 0 to 70 | 2771C | Samples |
| TLV2771ID | ACTIVE | SOIC | D | 8 | 75 | Green (RoHS & no Sb/Br) | CU NIPDAU | Level-1-260C-UNLIM | -40 to 125 | 2771I | Samples |
| TLV2771IDBVR | ACTIVE | SOT-23 | DBV | 5 | 3000 | Green (RoHS & no Sb/Br) | CU NIPDAU | Level-1-260C-UNLIM | -40 to 125 | VAMI | Samples |

| Orderable Device | Status (1) | Package Type | Package Drawing | Pins | Package Qty | Eco Plan (2) | Lead/Ball Finish (6) | MSL Peak Temp (3) | Op Temp (°C) | Device Marking (4/5) | Samples |
|------------------|---------------|--------------|-----------------|------|-------------|-------------------------|----------------------------|----------------------|--------------|-------------------------|-------------------------|
| TLV27711DBVT | ACTIVE | SOT-23 | DBV | 5 | 250 | Green (RoHS & no Sb/Br) | CU NIPDAU | Level-1-260C-UNLIM | -40 to 125 | VAMI | Samples |
| TLV27711DR | ACTIVE | SOIC | D | 8 | 2500 | Green (RoHS & no Sb/Br) | CU NIPDAU | Level-1-260C-UNLIM | -40 to 125 | 2771I | Samples |
| TLV2772AID | ACTIVE | SOIC | D | 8 | 75 | Green (RoHS & no Sb/Br) | CU NIPDAU | Level-1-260C-UNLIM | -40 to 125 | 2772AI | Samples |
| TLV2772AIDR | ACTIVE | SOIC | D | 8 | 2500 | Green (RoHS & no Sb/Br) | CU NIPDAU | Level-1-260C-UNLIM | -40 to 125 | 2772AI | Samples |
| TLV2772AIDRG4 | ACTIVE | SOIC | D | 8 | 2500 | Green (RoHS & no Sb/Br) | CU NIPDAU | Level-1-260C-UNLIM | -40 to 125 | 2772AI | Samples |
| TLV2772AIP | ACTIVE | PDIP | P | 8 | 50 | Green (RoHS & no Sb/Br) | CU NIPDAU | N / A for Pkg Type | -40 to 125 | TLV2772AI | Samples |
| TLV2772AMD | ACTIVE | SOIC | D | 8 | 75 | Green (RoHS & no Sb/Br) | CU NIPDAU | Level-1-260C-UNLIM | -55 to 125 | 2772AM | Samples |
| TLV2772AMDG4 | ACTIVE | SOIC | D | 8 | 75 | Green (RoHS & no Sb/Br) | CU NIPDAU | Level-1-260C-UNLIM | | 2772AM | Samples |
| TLV2772AMJGB | ACTIVE | CDIP | JG | 8 | 1 | TBD | A42 | N / A for Pkg Type | -55 to 125 | 9858802QPA TLV2772AM | Samples |
| TLV2772AQPW | ACTIVE | TSSOP | PW | 8 | 150 | Green (RoHS & no Sb/Br) | CU NIPDAU | Level-1-260C-UNLIM | -40 to 125 | 2772AQ | Samples |
| TLV2772CD | ACTIVE | SOIC | D | 8 | 75 | Green (RoHS & no Sb/Br) | CU NIPDAU | Level-1-260C-UNLIM | 0 to 70 | 2772C | Samples |
| TLV2772CDGK | ACTIVE | VSSOP | DGK | 8 | 80 | Green (RoHS & no Sb/Br) | CU NIPDAU CU NIPDAUAG | Level-1-260C-UNLIM | 0 to 70 | AAF | Samples |
| TLV2772CDGKR | ACTIVE | VSSOP | DGK | 8 | 2500 | Green (RoHS & no Sb/Br) | CU NIPDAU CU NIPDAUAG | Level-1-260C-UNLIM | 0 to 70 | AAF | Samples |
| TLV2772CDR | ACTIVE | SOIC | D | 8 | 2500 | Green (RoHS & no Sb/Br) | CU NIPDAU | Level-1-260C-UNLIM | 0 to 70 | 2772C | Samples |
| TLV2772CP | ACTIVE | PDIP | P | 8 | 50 | Green (RoHS & no Sb/Br) | CU NIPDAU | N / A for Pkg Type | 0 to 70 | TLV2772C | Samples |
| TLV2772ID | ACTIVE | SOIC | D | 8 | 75 | Green (RoHS & no Sb/Br) | CU NIPDAU | Level-1-260C-UNLIM | -40 to 125 | 2772I | Samples |
| TLV2772IDGK | ACTIVE | VSSOP | DGK | 8 | 80 | Green (RoHS & no Sb/Br) | CU NIPDAU CU NIPDAUAG | Level-1-260C-UNLIM | -40 to 125 | AAG | Samples |
| TLV2772IDGKR | ACTIVE | VSSOP | DGK | 8 | 2500 | Green (RoHS & no Sb/Br) | CU NIPDAU CU NIPDAUAG | Level-1-260C-UNLIM | -40 to 125 | AAG | Samples |

| Orderable Device | Status (1) | Package Type | Package Drawing | Pins | Package Qty | Eco Plan (2) | Lead/Ball Finish (6) | MSL Peak Temp (3) | Op Temp (°C) | Device Marking (4/5) | Samples |
|------------------|---------------|--------------|-----------------|------|-------------|-------------------------|-------------------------|----------------------|--------------|-------------------------|-------------------------|
| TLV2772IDR | ACTIVE | SOIC | D | 8 | 2500 | Green (RoHS & no Sb/Br) | CU NIPDAU | Level-1-260C-UNLIM | -40 to 125 | 2772I | Samples |
| TLV2772IP | ACTIVE | PDIP | P | 8 | 50 | Green (RoHS & no Sb/Br) | CU NIPDAU | N / A for Pkg Type | -40 to 125 | TLV2772IP | Samples |
| TLV2772MD | ACTIVE | SOIC | D | 8 | 75 | Green (RoHS & no Sb/Br) | CU NIPDAU | Level-1-260C-UNLIM | -55 to 125 | 2772M | Samples |
| TLV2772MDR | ACTIVE | SOIC | D | 8 | 2500 | Green (RoHS & no Sb/Br) | CU NIPDAU | Level-1-260C-UNLIM | -55 to 125 | 2772M | Samples |
| TLV2772QD | ACTIVE | SOIC | D | 8 | 75 | Green (RoHS & no Sb/Br) | CU NIPDAU | Level-1-260C-UNLIM | -40 to 125 | 2772Q | Samples |
| TLV2772QPW | ACTIVE | TSSOP | PW | 8 | 150 | Green (RoHS & no Sb/Br) | CU NIPDAU | Level-1-260C-UNLIM | -40 to 125 | 2772Q | Samples |
| TLV2772QPWR | ACTIVE | TSSOP | PW | 8 | 2000 | Green (RoHS & no Sb/Br) | CU NIPDAU | Level-1-260C-UNLIM | -40 to 125 | 2772Q | Samples |
| TLV2772QPWRG4 | ACTIVE | TSSOP | PW | 8 | 2000 | Green (RoHS & no Sb/Br) | CU NIPDAU | Level-1-260C-UNLIM | | 2772Q | Samples |
| TLV2773AIN | ACTIVE | PDIP | N | 14 | 25 | Green (RoHS & no Sb/Br) | CU NIPDAU | N / A for Pkg Type | -40 to 125 | TLV2773AI | Samples |
| TLV2773CDGS | ACTIVE | VSSOP | DGS | 10 | 80 | Green (RoHS & no Sb/Br) | CU NIPDAU | Level-1-260C-UNLIM | 0 to 70 | ABQ | Samples |
| TLV2773CDGSG4 | ACTIVE | VSSOP | DGS | 10 | 80 | Green (RoHS & no Sb/Br) | CU NIPDAU | Level-1-260C-UNLIM | 0 to 70 | ABQ | Samples |
| TLV2773IDGSR | ACTIVE | VSSOP | DGS | 10 | 2500 | Green (RoHS & no Sb/Br) | CU NIPDAU | Level-1-260C-UNLIM | -40 to 125 | ABR | Samples |
| TLV2774AID | ACTIVE | SOIC | D | 14 | 50 | Green (RoHS & no Sb/Br) | CU NIPDAU | Level-1-260C-UNLIM | -40 to 125 | TLV2774A | Samples |
| TLV2774AIDR | ACTIVE | SOIC | D | 14 | 2500 | Green (RoHS & no Sb/Br) | CU NIPDAU | Level-1-260C-UNLIM | -40 to 125 | TLV2774A | Samples |
| TLV2774AIN | ACTIVE | PDIP | N | 14 | 25 | Green (RoHS & no Sb/Br) | CU NIPDAU | N / A for Pkg Type | -40 to 125 | TLV2774A | Samples |
| TLV2774AIPW | ACTIVE | TSSOP | PW | 14 | 90 | Green (RoHS & no Sb/Br) | CU NIPDAU | Level-1-260C-UNLIM | -40 to 125 | TY2774A | Samples |
| TLV2774CD | ACTIVE | SOIC | D | 14 | 50 | Green (RoHS & no Sb/Br) | CU NIPDAU | Level-1-260C-UNLIM | 0 to 70 | TLV2774C | Samples |
| TLV2774CDG4 | ACTIVE | SOIC | D | 14 | 50 | Green (RoHS & no Sb/Br) | CU NIPDAU | Level-1-260C-UNLIM | 0 to 70 | TLV2774C | Samples |

| Orderable Device | Status (1) | Package Type | Package Drawing | Pins | Package Qty | Eco Plan (2) | Lead/Ball Finish (6) | MSL Peak Temp (3) | Op Temp (°C) | Device Marking (4/5) | Samples |
|------------------|---------------|--------------|-----------------|------|-------------|-------------------------|-------------------------|----------------------|--------------|-------------------------|-------------------------|
| TLV2774CDR | ACTIVE | SOIC | D | 14 | 2500 | Green (RoHS & no Sb/Br) | CU NIPDAU | Level-1-260C-UNLIM | 0 to 70 | TLV2774C | Samples |
| TLV2774CN | ACTIVE | PDIP | N | 14 | 25 | Green (RoHS & no Sb/Br) | CU NIPDAU | N / A for Pkg Type | 0 to 70 | TLV2774C | Samples |
| TLV2774CPW | ACTIVE | TSSOP | PW | 14 | 90 | Green (RoHS & no Sb/Br) | CU NIPDAU | Level-1-260C-UNLIM | 0 to 70 | 2774C | Samples |
| TLV2774CPWR | ACTIVE | TSSOP | PW | 14 | 2000 | Green (RoHS & no Sb/Br) | CU NIPDAU | Level-1-260C-UNLIM | 0 to 70 | TV2774 | Samples |
| TLV2774ID | ACTIVE | SOIC | D | 14 | 50 | Green (RoHS & no Sb/Br) | CU NIPDAU | Level-1-260C-UNLIM | -40 to 125 | TLV2774I | Samples |
| TLV2774IDG4 | ACTIVE | SOIC | D | 14 | 50 | Green (RoHS & no Sb/Br) | CU NIPDAU | Level-1-260C-UNLIM | -40 to 125 | TLV2774I | Samples |
| TLV2774IDR | ACTIVE | SOIC | D | 14 | 2500 | Green (RoHS & no Sb/Br) | CU NIPDAU | Level-1-260C-UNLIM | -40 to 125 | TLV2774I | Samples |
| TLV2774IN | ACTIVE | PDIP | N | 14 | 25 | Green (RoHS & no Sb/Br) | CU NIPDAU | N / A for Pkg Type | -40 to 125 | TLV2774I | Samples |
| TLV2774IPW | ACTIVE | TSSOP | PW | 14 | 90 | Green (RoHS & no Sb/Br) | CU NIPDAU | Level-1-260C-UNLIM | -40 to 125 | TY2774 | Samples |
| TLV2774IPWR | ACTIVE | TSSOP | PW | 14 | 2000 | Green (RoHS & no Sb/Br) | CU NIPDAU | Level-1-260C-UNLIM | -40 to 125 | TY2774 | Samples |
| TLV2774IPWRG4 | ACTIVE | TSSOP | PW | 14 | 2000 | Green (RoHS & no Sb/Br) | CU NIPDAU | Level-1-260C-UNLIM | -40 to 125 | TY2774 | Samples |
| TLV2775AIN | ACTIVE | PDIP | N | 16 | 25 | Green (RoHS & no Sb/Br) | CU NIPDAU | N / A for Pkg Type | -40 to 125 | TLV2775A | Samples |
| TLV2775AIPW | ACTIVE | TSSOP | PW | 16 | 90 | Green (RoHS & no Sb/Br) | CU NIPDAU | Level-1-260C-UNLIM | -40 to 125 | 2775AI | Samples |
| TLV2775CN | ACTIVE | PDIP | N | 16 | 25 | Green (RoHS & no Sb/Br) | CU NIPDAU | N / A for Pkg Type | 0 to 70 | TLV2775C | Samples |
| TLV2775ID | ACTIVE | SOIC | D | 16 | 40 | Green (RoHS & no Sb/Br) | CU NIPDAU | Level-1-260C-UNLIM | -40 to 125 | TLV2775I | Samples |
| TLV2775IDR | ACTIVE | SOIC | D | 16 | 2500 | Green (RoHS & no Sb/Br) | CU NIPDAU | Level-1-260C-UNLIM | -40 to 125 | TLV2775I | Samples |
| TLV2775IPWR | ACTIVE | TSSOP | PW | 16 | 2000 | Green (RoHS & no Sb/Br) | CU NIPDAU | Level-1-260C-UNLIM | -40 to 125 | 2775I | Samples |
| TLV2775IPWRG4 | ACTIVE | TSSOP | PW | 16 | 2000 | Green (RoHS & no Sb/Br) | CU NIPDAU | Level-1-260C-UNLIM | -40 to 125 | 2775I | Samples |

(1) The marketing status values are defined as follows:

ACTIVE: Product device recommended for new designs.

LIFEBUY: TI has announced that the device will be discontinued, and a lifetime-buy period is in effect.

NRND: Not recommended for new designs. Device is in production to support existing customers, but TI does not recommend using this part in a new design.

PREVIEW: Device has been announced but is not in production. Samples may or may not be available.

OBSOLETE: TI has discontinued the production of the device.

(2) **RoHS:** TI defines "RoHS" to mean semiconductor products that are compliant with the current EU RoHS requirements for all 10 RoHS substances, including the requirement that RoHS substance do not exceed 0.1% by weight in homogeneous materials. Where designed to be soldered at high temperatures, "RoHS" products are suitable for use in specified lead-free processes. TI may reference these types of products as "Pb-Free".

RoHS Exempt: TI defines "RoHS Exempt" to mean products that contain lead but are compliant with EU RoHS pursuant to a specific EU RoHS exemption.

Green: TI defines "Green" to mean the content of Chlorine (Cl) and Bromine (Br) based flame retardants meet JS709B low halogen requirements of ≤ 1000 ppm threshold. Antimony trioxide based flame retardants must also meet the ≤ 1000 ppm threshold requirement.

(3) MSL, Peak Temp. - The Moisture Sensitivity Level rating according to the JEDEC industry standard classifications, and peak solder temperature.

(4) There may be additional marking, which relates to the logo, the lot trace code information, or the environmental category on the device.

(5) Multiple Device Markings will be inside parentheses. Only one Device Marking contained in parentheses and separated by a "~" will appear on a device. If a line is indented then it is a continuation of the previous line and the two combined represent the entire Device Marking for that device.

(6) Lead/Ball Finish - Orderable Devices may have multiple material finish options. Finish options are separated by a vertical ruled line. Lead/Ball Finish values may wrap to two lines if the finish value exceeds the maximum column width.

Important Information and Disclaimer: The information provided on this page represents TI's knowledge and belief as of the date that it is provided. TI bases its knowledge and belief on information provided by third parties, and makes no representation or warranty as to the accuracy of such information. Efforts are underway to better integrate information from third parties. TI has taken and continues to take reasonable steps to provide representative and accurate information but may not have conducted destructive testing or chemical analysis on incoming materials and chemicals. TI and TI suppliers consider certain information to be proprietary, and thus CAS numbers and other limited information may not be available for release.

In no event shall TI's liability arising out of such information exceed the total purchase price of the TI part(s) at issue in this document sold by TI to Customer on an annual basis.

OTHER QUALIFIED VERSIONS OF TLV2771, TLV2772, TLV2772A, TLV2772AM, TLV2774, TLV2774A :

● Catalog: [TLV2772A](#)

● Automotive: [TLV2771-Q1](#), [TLV2772-Q1](#), [TLV2772A-Q1](#), [TLV2772A-Q1](#)

● Enhanced Product: [TLV2772A-EP](#), [TLV2772A-EP](#), [TLV2774-EP](#), [TLV2774A-EP](#)

- Military: [TLV2772AM](#)

NOTE: Qualified Version Definitions:

- Catalog - TI's standard catalog product
- Automotive - Q100 devices qualified for high-reliability automotive applications targeting zero defects
- Enhanced Product - Supports Defense, Aerospace and Medical Applications
- Military - QML certified for Military and Defense Applications

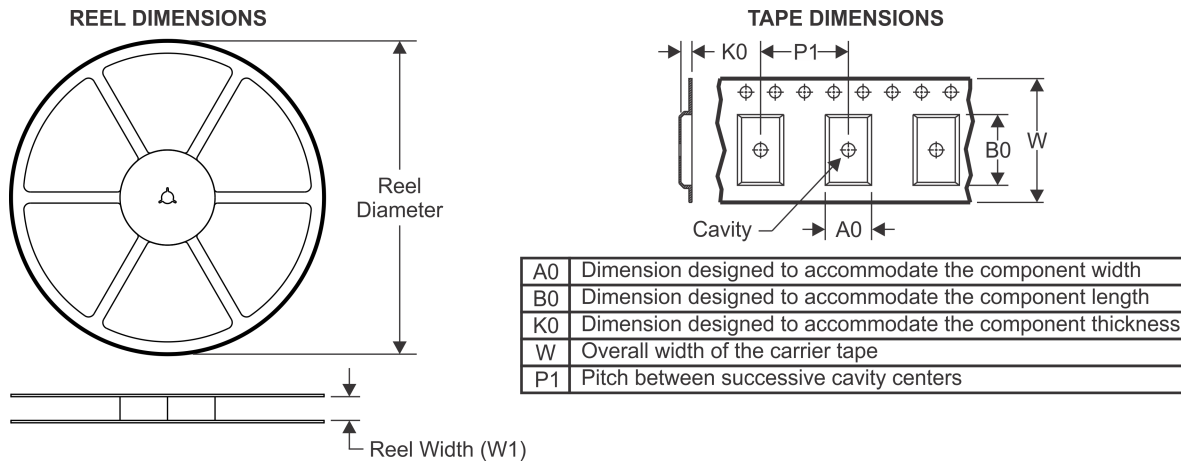
TAPE AND REEL INFORMATION

QUADRANT ASSIGNMENTS FOR PIN 1 ORIENTATION IN TAPE

*All dimensions are nominal

| Device | Package Type | Package Drawing | Pins | SPQ | Reel Diameter (mm) | Reel Width W1 (mm) | A0 (mm) | B0 (mm) | K0 (mm) | P1 (mm) | W (mm) | Pin1 Quadrant |
|--------------|--------------|-----------------|------|------|--------------------|--------------------|---------|---------|---------|---------|--------|---------------|
| TLV2770CDR | SOIC | D | 8 | 2500 | 330.0 | 12.4 | 6.4 | 5.2 | 2.1 | 8.0 | 12.0 | Q1 |
| TLV2770IDGKR | VSSOP | DGK | 8 | 2500 | 330.0 | 12.4 | 5.3 | 3.4 | 1.4 | 8.0 | 12.0 | Q1 |
| TLV2770IDR | SOIC | D | 8 | 2500 | 330.0 | 12.4 | 6.4 | 5.2 | 2.1 | 8.0 | 12.0 | Q1 |
| TLV2771AIDR | SOIC | D | 8 | 2500 | 330.0 | 12.4 | 6.4 | 5.2 | 2.1 | 8.0 | 12.0 | Q1 |
| TLV2771CDBVR | SOT-23 | DBV | 5 | 3000 | 178.0 | 9.0 | 3.3 | 3.2 | 1.4 | 4.0 | 8.0 | Q3 |
| TLV2771CDBVT | SOT-23 | DBV | 5 | 250 | 178.0 | 9.0 | 3.3 | 3.2 | 1.4 | 4.0 | 8.0 | Q3 |
| TLV2771CDR | SOIC | D | 8 | 2500 | 330.0 | 12.4 | 6.4 | 5.2 | 2.1 | 8.0 | 12.0 | Q1 |
| TLV2771IDBVR | SOT-23 | DBV | 5 | 3000 | 178.0 | 9.0 | 3.3 | 3.2 | 1.4 | 4.0 | 8.0 | Q3 |
| TLV2771IDBVT | SOT-23 | DBV | 5 | 250 | 178.0 | 9.0 | 3.3 | 3.2 | 1.4 | 4.0 | 8.0 | Q3 |
| TLV2771IDR | SOIC | D | 8 | 2500 | 330.0 | 12.4 | 6.4 | 5.2 | 2.1 | 8.0 | 12.0 | Q1 |
| TLV2772AIDR | SOIC | D | 8 | 2500 | 330.0 | 12.4 | 6.4 | 5.2 | 2.1 | 8.0 | 12.0 | Q1 |
| TLV2772CDGKR | VSSOP | DGK | 8 | 2500 | 330.0 | 12.4 | 5.3 | 3.4 | 1.4 | 8.0 | 12.0 | Q1 |
| TLV2772CDGKR | VSSOP | DGK | 8 | 2500 | 330.0 | 12.4 | 5.3 | 3.4 | 1.4 | 8.0 | 12.0 | Q1 |
| TLV2772CDR | SOIC | D | 8 | 2500 | 330.0 | 12.4 | 6.4 | 5.2 | 2.1 | 8.0 | 12.0 | Q1 |
| TLV2772IDGKR | VSSOP | DGK | 8 | 2500 | 330.0 | 12.4 | 5.3 | 3.4 | 1.4 | 8.0 | 12.0 | Q1 |
| TLV2772IDGKR | VSSOP | DGK | 8 | 2500 | 330.0 | 12.4 | 5.3 | 3.4 | 1.4 | 8.0 | 12.0 | Q1 |
| TLV2772IDR | SOIC | D | 8 | 2500 | 330.0 | 12.4 | 6.4 | 5.2 | 2.1 | 8.0 | 12.0 | Q1 |
| TLV2772MDR | SOIC | D | 8 | 2500 | 330.0 | 12.4 | 6.4 | 5.2 | 2.1 | 8.0 | 12.0 | Q1 |

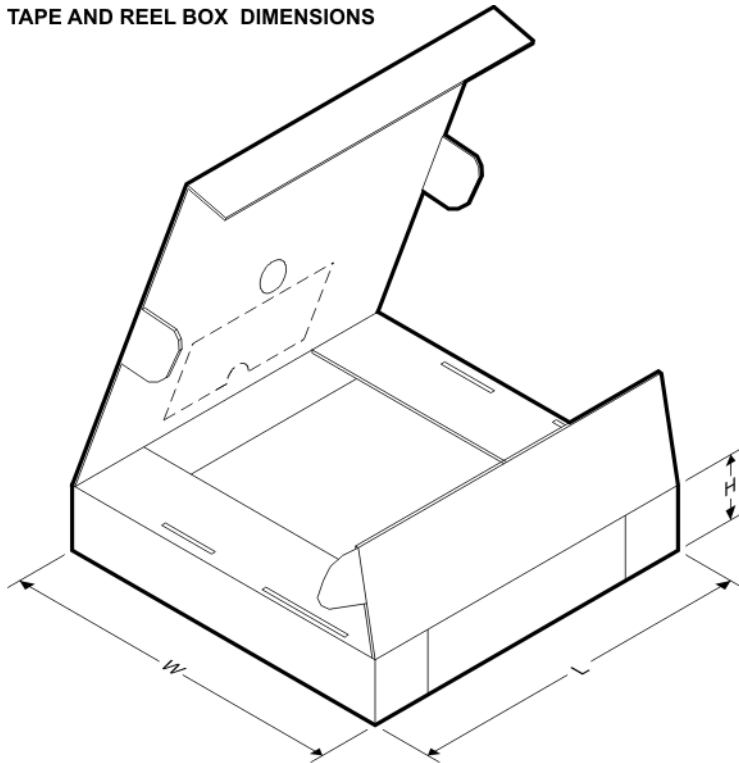
| Device | Package Type | Package Drawing | Pins | SPQ | Reel Diameter (mm) | Reel Width W1 (mm) | A0 (mm) | B0 (mm) | K0 (mm) | P1 (mm) | W (mm) | Pin1 Quadrant |
|---------------|--------------|-----------------|------|------|--------------------|--------------------|---------|---------|---------|---------|--------|---------------|
| TLV2772QPWR | TSSOP | PW | 8 | 2000 | 330.0 | 12.4 | 7.0 | 3.6 | 1.6 | 8.0 | 12.0 | Q1 |
| TLV2772QPWRG4 | TSSOP | PW | 8 | 2000 | 330.0 | 12.4 | 7.0 | 3.6 | 1.6 | 8.0 | 12.0 | Q1 |
| TLV2773IDGSR | VSSOP | DGS | 10 | 2500 | 330.0 | 12.4 | 5.3 | 3.4 | 1.4 | 8.0 | 12.0 | Q1 |
| TLV2774AIDR | SOIC | D | 14 | 2500 | 330.0 | 16.4 | 6.5 | 9.0 | 2.1 | 8.0 | 16.0 | Q1 |
| TLV2774CDR | SOIC | D | 14 | 2500 | 330.0 | 16.4 | 6.5 | 9.0 | 2.1 | 8.0 | 16.0 | Q1 |
| TLV2774CPWR | TSSOP | PW | 14 | 2000 | 330.0 | 12.4 | 6.9 | 5.6 | 1.6 | 8.0 | 12.0 | Q1 |
| TLV2774IDR | SOIC | D | 14 | 2500 | 330.0 | 16.4 | 6.5 | 9.0 | 2.1 | 8.0 | 16.0 | Q1 |
| TLV2774IPWR | TSSOP | PW | 14 | 2000 | 330.0 | 12.4 | 6.9 | 5.6 | 1.6 | 8.0 | 12.0 | Q1 |
| TLV2775IDR | SOIC | D | 16 | 2500 | 330.0 | 16.4 | 6.5 | 10.3 | 2.1 | 8.0 | 16.0 | Q1 |
| TLV2775IPWR | TSSOP | PW | 16 | 2000 | 330.0 | 12.4 | 6.9 | 5.6 | 1.6 | 8.0 | 12.0 | Q1 |

TAPE AND REEL BOX DIMENSIONS

*All dimensions are nominal

| Device | Package Type | Package Drawing | Pins | SPQ | Length (mm) | Width (mm) | Height (mm) |
|--------------|--------------|-----------------|------|------|-------------|------------|-------------|
| TLV2770CDR | SOIC | D | 8 | 2500 | 340.5 | 338.1 | 20.6 |
| TLV2770IDGKR | VSSOP | DGK | 8 | 2500 | 358.0 | 335.0 | 35.0 |
| TLV2770IDR | SOIC | D | 8 | 2500 | 340.5 | 338.1 | 20.6 |
| TLV2771AIDR | SOIC | D | 8 | 2500 | 340.5 | 338.1 | 20.6 |
| TLV2771CDBVR | SOT-23 | DBV | 5 | 3000 | 180.0 | 180.0 | 18.0 |
| TLV2771CDBVT | SOT-23 | DBV | 5 | 250 | 180.0 | 180.0 | 18.0 |
| TLV2771CDR | SOIC | D | 8 | 2500 | 340.5 | 338.1 | 20.6 |

| Device | Package Type | Package Drawing | Pins | SPQ | Length (mm) | Width (mm) | Height (mm) |
|---------------|--------------|-----------------|------|------|-------------|------------|-------------|
| TLV2771IDBVR | SOT-23 | DBV | 5 | 3000 | 180.0 | 180.0 | 18.0 |
| TLV2771IDBVT | SOT-23 | DBV | 5 | 250 | 180.0 | 180.0 | 18.0 |
| TLV2771IDR | SOIC | D | 8 | 2500 | 340.5 | 338.1 | 20.6 |
| TLV2772AIDR | SOIC | D | 8 | 2500 | 340.5 | 338.1 | 20.6 |
| TLV2772CDGKR | VSSOP | DGK | 8 | 2500 | 358.0 | 335.0 | 35.0 |
| TLV2772CDGKR | VSSOP | DGK | 8 | 2500 | 364.0 | 364.0 | 27.0 |
| TLV2772CDR | SOIC | D | 8 | 2500 | 340.5 | 338.1 | 20.6 |
| TLV2772IDGKR | VSSOP | DGK | 8 | 2500 | 358.0 | 335.0 | 35.0 |
| TLV2772IDGKR | VSSOP | DGK | 8 | 2500 | 364.0 | 364.0 | 27.0 |
| TLV2772IDR | SOIC | D | 8 | 2500 | 340.5 | 338.1 | 20.6 |
| TLV2772MDR | SOIC | D | 8 | 2500 | 350.0 | 350.0 | 43.0 |
| TLV2772QPWR | TSSOP | PW | 8 | 2000 | 367.0 | 367.0 | 35.0 |
| TLV2772QPWRG4 | TSSOP | PW | 8 | 2000 | 367.0 | 367.0 | 35.0 |
| TLV2773IDGSR | VSSOP | DGS | 10 | 2500 | 358.0 | 335.0 | 35.0 |
| TLV2774AIDR | SOIC | D | 14 | 2500 | 350.0 | 350.0 | 43.0 |
| TLV2774CDR | SOIC | D | 14 | 2500 | 350.0 | 350.0 | 43.0 |
| TLV2774CPWR | TSSOP | PW | 14 | 2000 | 367.0 | 367.0 | 35.0 |
| TLV2774IDR | SOIC | D | 14 | 2500 | 350.0 | 350.0 | 43.0 |
| TLV2774IPWR | TSSOP | PW | 14 | 2000 | 367.0 | 367.0 | 35.0 |
| TLV2775IDR | SOIC | D | 16 | 2500 | 350.0 | 350.0 | 43.0 |
| TLV2775IPWR | TSSOP | PW | 16 | 2000 | 367.0 | 367.0 | 35.0 |

D (R-PDSO-G16)

PLASTIC SMALL OUTLINE

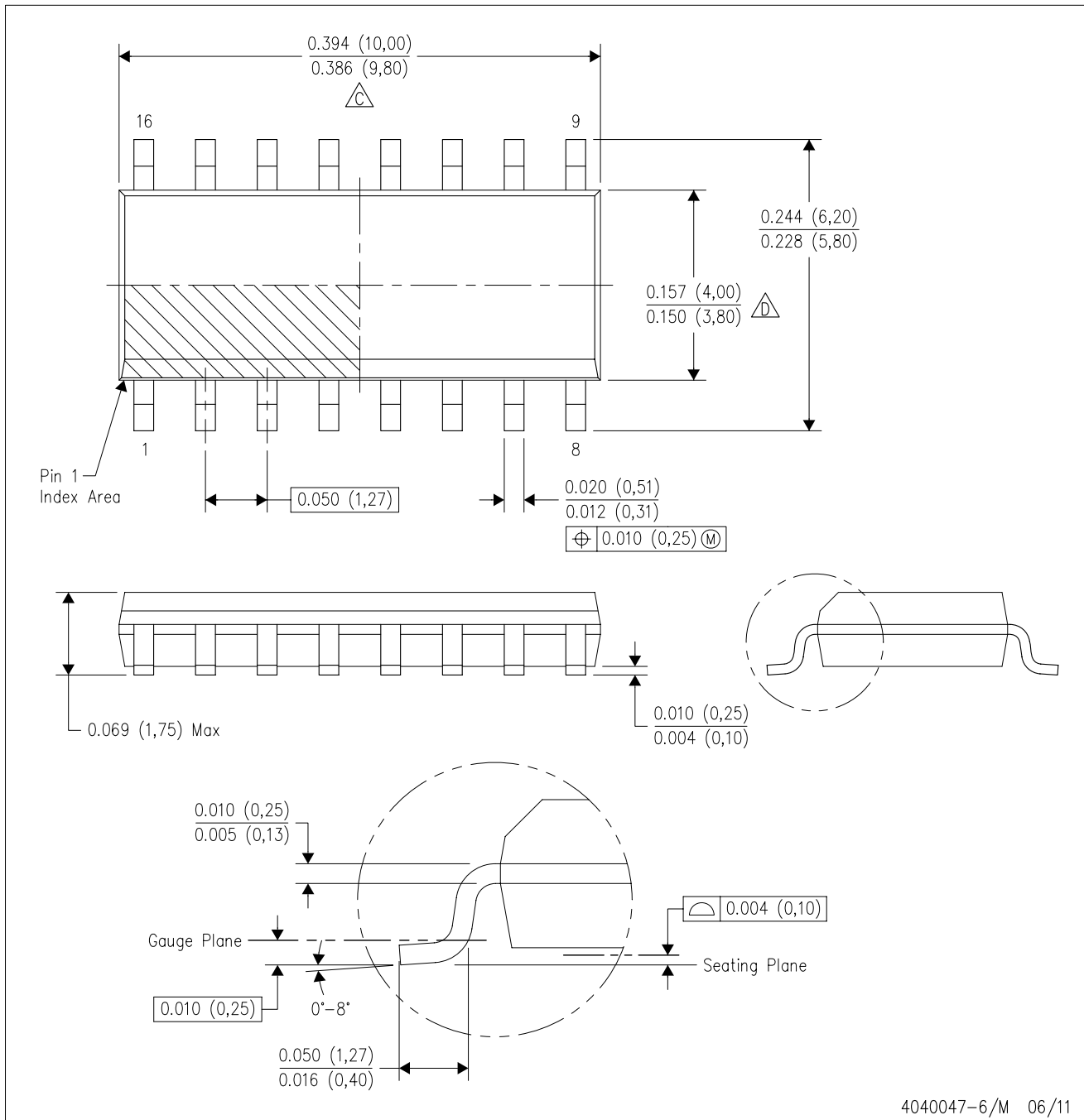

- NOTES:
- A. All linear dimensions are in inches (millimeters).
 - B. This drawing is subject to change without notice.
 - C. Body length does not include mold flash, protrusions, or gate burrs. Mold flash, protrusions, or gate burrs shall not exceed 0.006 (0,15) each side.
 - D. Body width does not include interlead flash. Interlead flash shall not exceed 0.017 (0,43) each side.
 - E. Reference JEDEC MS-012 variation AC.

D (R-PDSO-G16)

PLASTIC SMALL OUTLINE

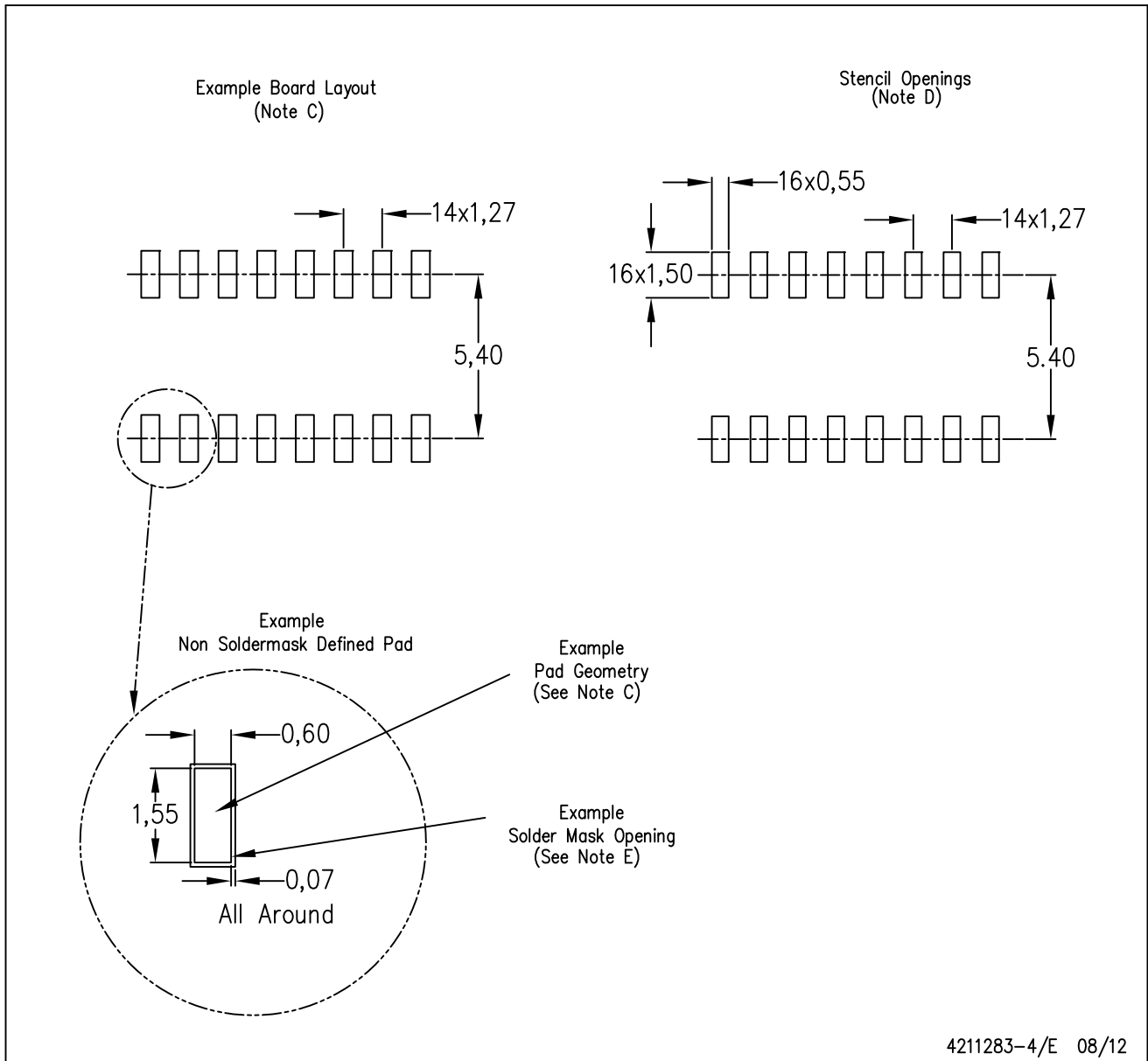

- NOTES:
- All linear dimensions are in millimeters.
 - This drawing is subject to change without notice.
 - Publication IPC-7351 is recommended for alternate designs.
 - Laser cutting apertures with trapezoidal walls and also rounding corners will offer better paste release. Customers should contact their board assembly site for stencil design recommendations. Refer to IPC-7525 for other stencil recommendations.
 - Customers should contact their board fabrication site for solder mask tolerances between and around signal pads.

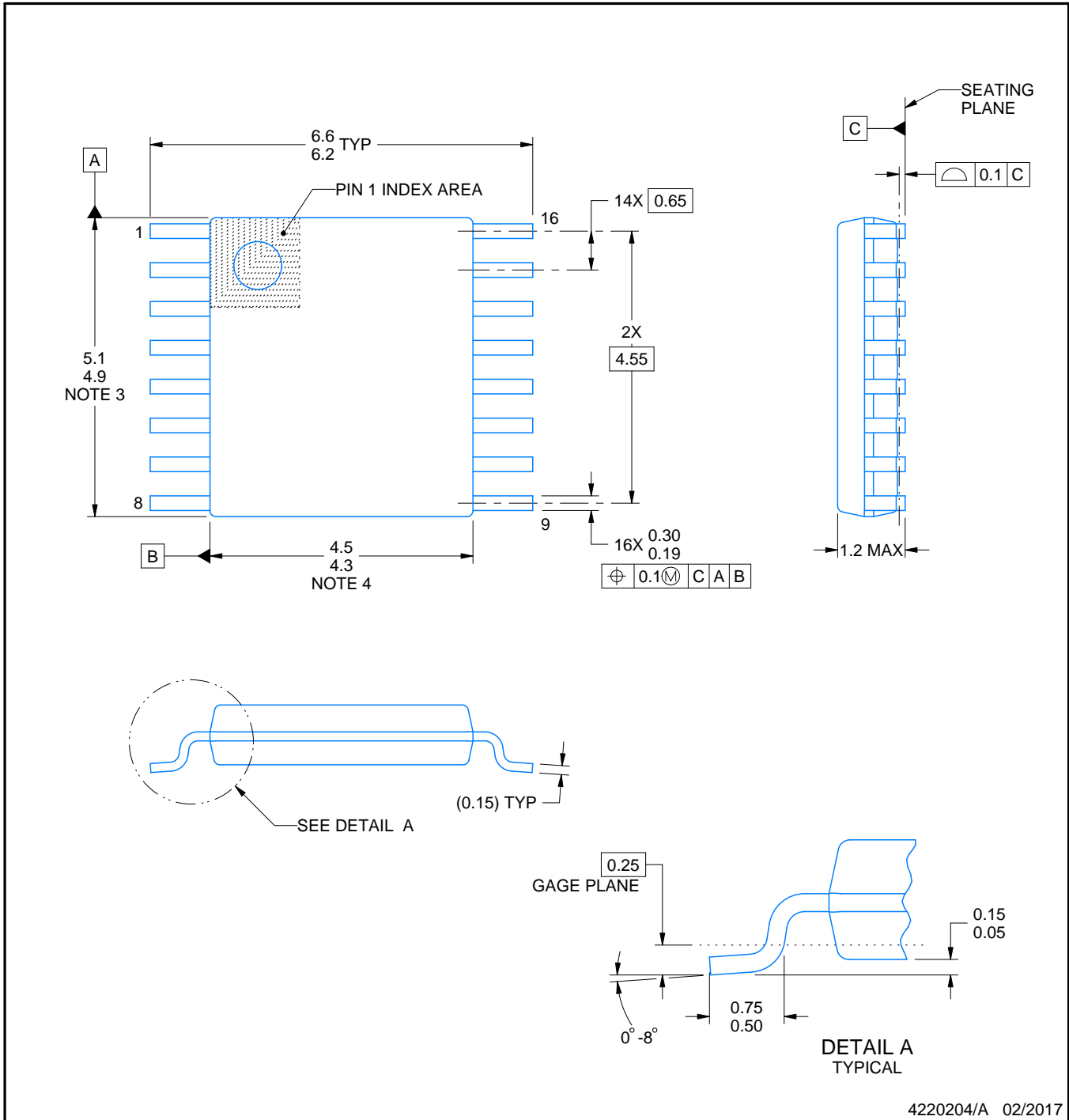
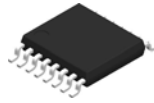

NOTES:

1. All linear dimensions are in millimeters. Any dimensions in parenthesis are for reference only. Dimensioning and tolerancing per ASME Y14.5M.
2. This drawing is subject to change without notice.
3. This dimension does not include mold flash, protrusions, or gate burrs. Mold flash, protrusions, or gate burrs shall not exceed 0.15 mm per side.
4. This dimension does not include interlead flash. Interlead flash shall not exceed 0.25 mm per side.
5. Reference JEDEC registration MO-153.

EXAMPLE BOARD LAYOUT

PW0016A

TSSOP - 1.2 mm max height

SMALL OUTLINE PACKAGE

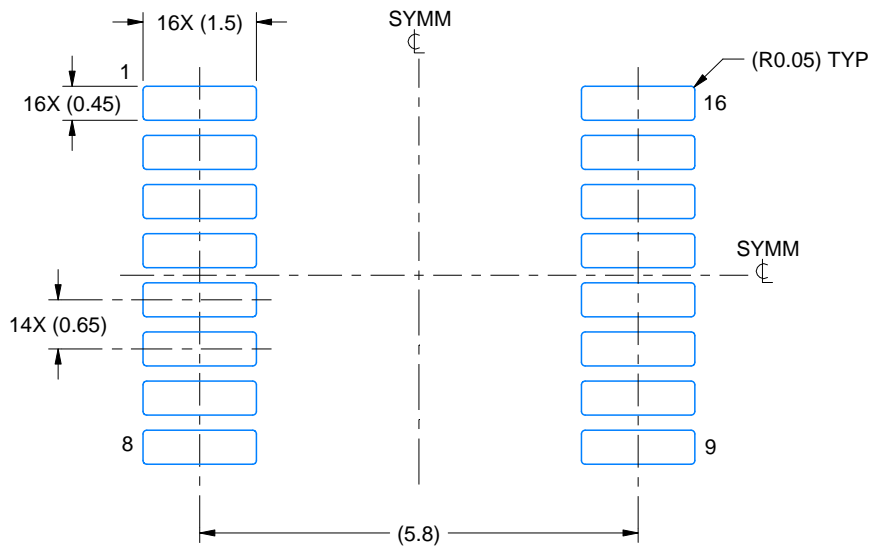

LAND PATTERN EXAMPLE
EXPOSED METAL SHOWN
SCALE: 10X

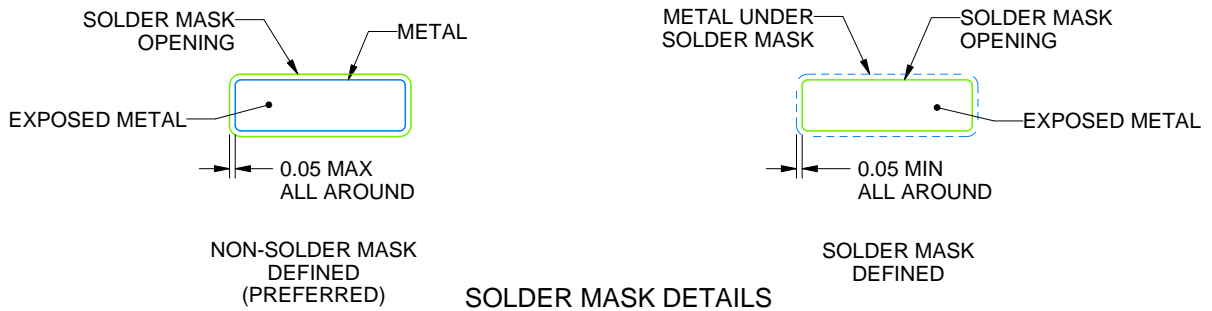

4220204/A 02/2017

NOTES: (continued)

- 6. Publication IPC-7351 may have alternate designs.
- 7. Solder mask tolerances between and around signal pads can vary based on board fabrication site.

EXAMPLE STENCIL DESIGN

PW0016A

TSSOP - 1.2 mm max height

SMALL OUTLINE PACKAGE

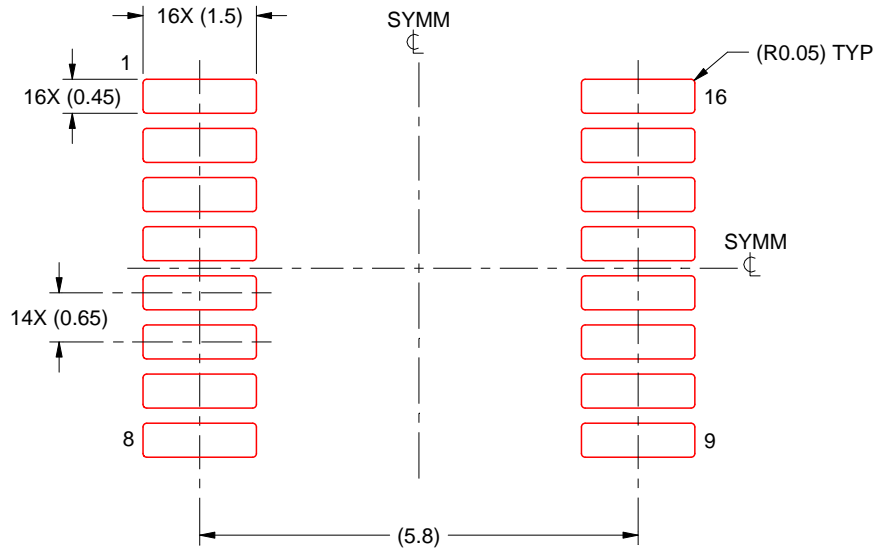

SOLDER PASTE EXAMPLE
BASED ON 0.125 mm THICK STENCIL
SCALE: 10X

4220204/A 02/2017

NOTES: (continued)

8. Laser cutting apertures with trapezoidal walls and rounded corners may offer better paste release. IPC-7525 may have alternate design recommendations.
9. Board assembly site may have different recommendations for stencil design.

DGS0010A



PACKAGE OUTLINE

VSSOP - 1.1 mm max height

SMALL OUTLINE PACKAGE

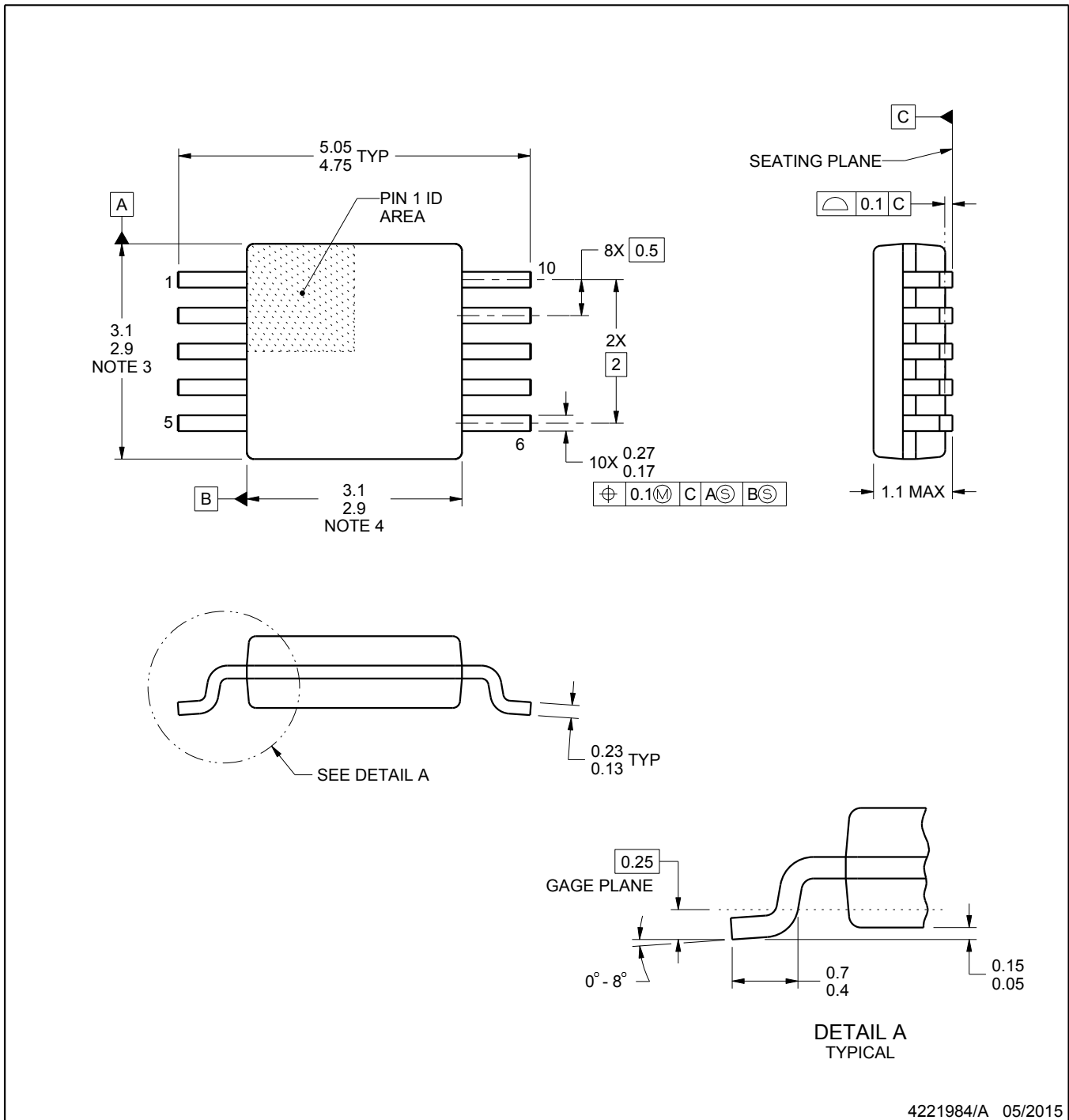

4221984/A 05/2015

NOTES:

1. All linear dimensions are in millimeters. Any dimensions in parenthesis are for reference only. Dimensioning and tolerancing per ASME Y14.5M.
2. This drawing is subject to change without notice.
3. This dimension does not include mold flash, protrusions, or gate burrs. Mold flash, protrusions, or gate burrs shall not exceed 0.15 mm per side.
4. This dimension does not include interlead flash. Interlead flash shall not exceed 0.25 mm per side.
5. Reference JEDEC registration MO-187, variation BA.

EXAMPLE BOARD LAYOUT

DGS0010A

VSSOP - 1.1 mm max height

SMALL OUTLINE PACKAGE

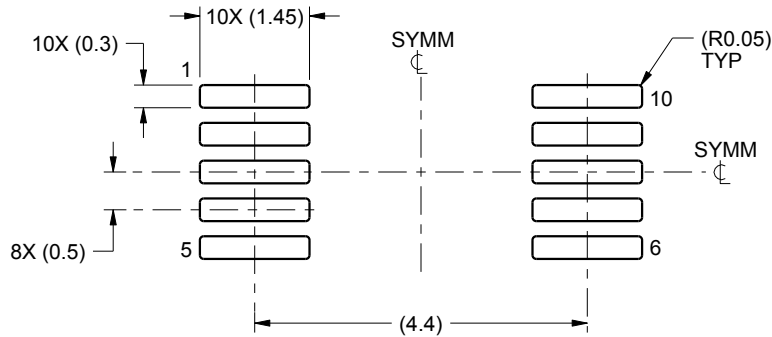

LAND PATTERN EXAMPLE
SCALE:10X

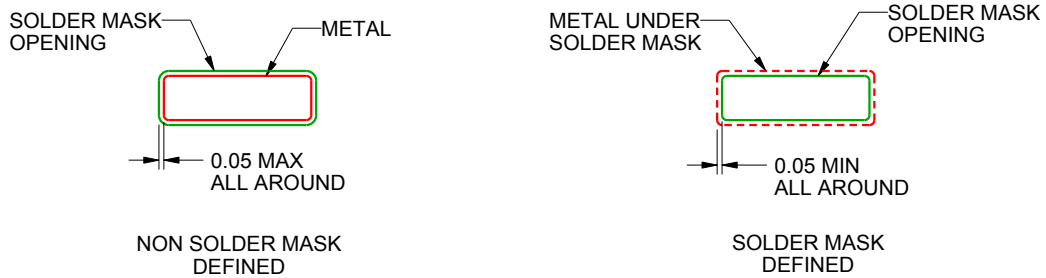

SOLDER MASK DETAILS
NOT TO SCALE

4221984/A 05/2015

NOTES: (continued)

- 6. Publication IPC-7351 may have alternate designs.
- 7. Solder mask tolerances between and around signal pads can vary based on board fabrication site.

EXAMPLE STENCIL DESIGN

DGS0010A

VSSOP - 1.1 mm max height

SMALL OUTLINE PACKAGE

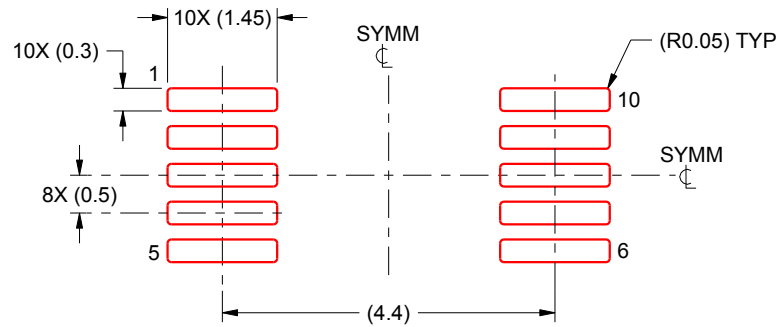

SOLDER PASTE EXAMPLE
BASED ON 0.125 mm THICK STENCIL
SCALE:10X

4221984/A 05/2015

NOTES: (continued)

8. Laser cutting apertures with trapezoidal walls and rounded corners may offer better paste release. IPC-7525 may have alternate design recommendations.
9. Board assembly site may have different recommendations for stencil design.

D (R-PDSO-G14)

PLASTIC SMALL OUTLINE

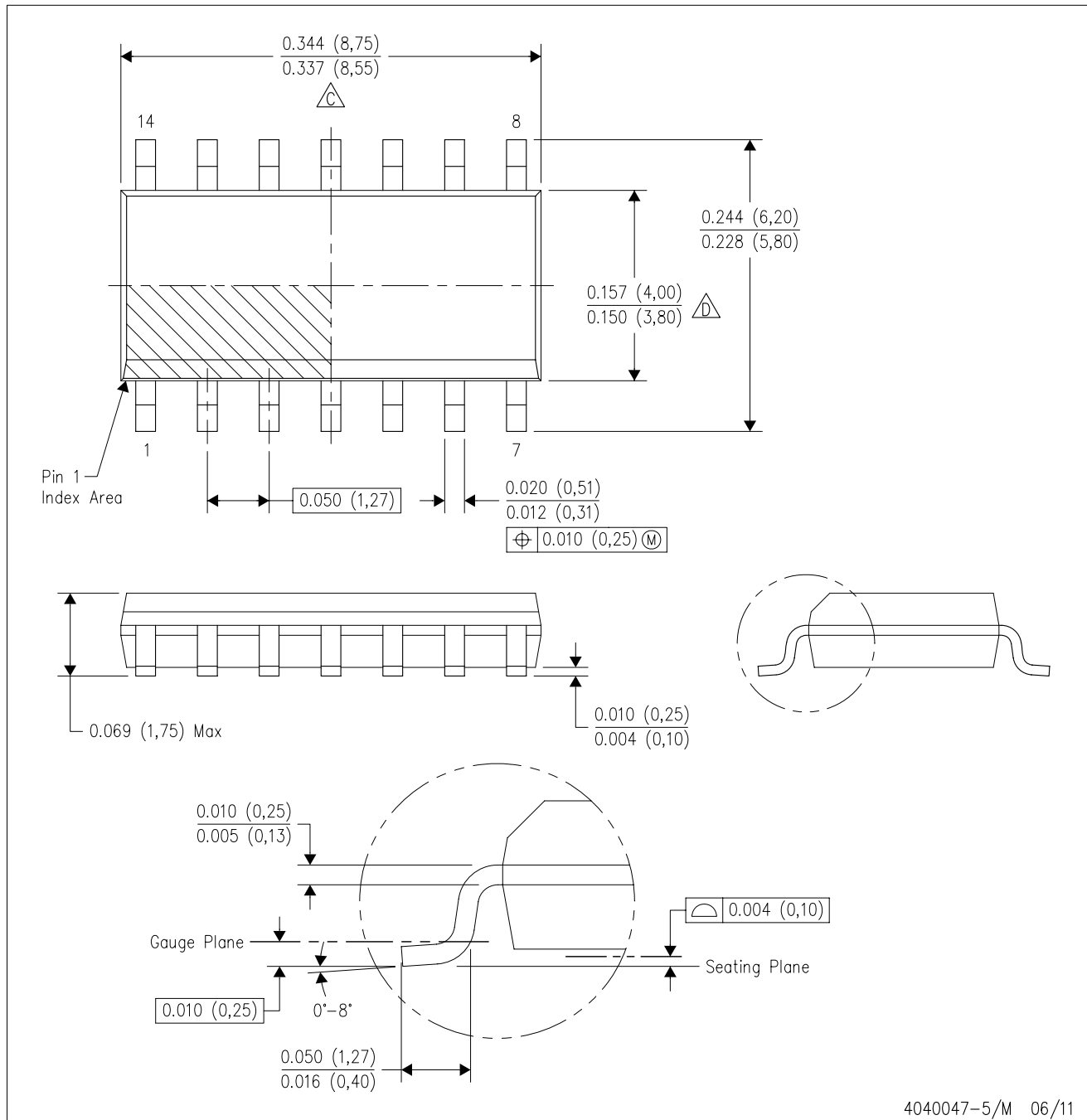

- NOTES:
- A. All linear dimensions are in inches (millimeters).
 - B. This drawing is subject to change without notice.
 - $\triangle C$ Body length does not include mold flash, protrusions, or gate burrs. Mold flash, protrusions, or gate burrs shall not exceed 0.006 (0,15) each side.
 - $\triangle D$ Body width does not include interlead flash. Interlead flash shall not exceed 0.017 (0,43) each side.
 - E. Reference JEDEC MS-012 variation AB.

D (R-PDSO-G14)

PLASTIC SMALL OUTLINE



4211283-3/E 08/12

- NOTES:
- All linear dimensions are in millimeters.
 - This drawing is subject to change without notice.
 - Publication IPC-7351 is recommended for alternate designs.
 - Laser cutting apertures with trapezoidal walls and also rounding corners will offer better paste release. Customers should contact their board assembly site for stencil design recommendations. Refer to IPC-7525 for other stencil recommendations.
 - Customers should contact their board fabrication site for solder mask tolerances between and around signal pads.

PW (R-PDSO-G14)

PLASTIC SMALL OUTLINE

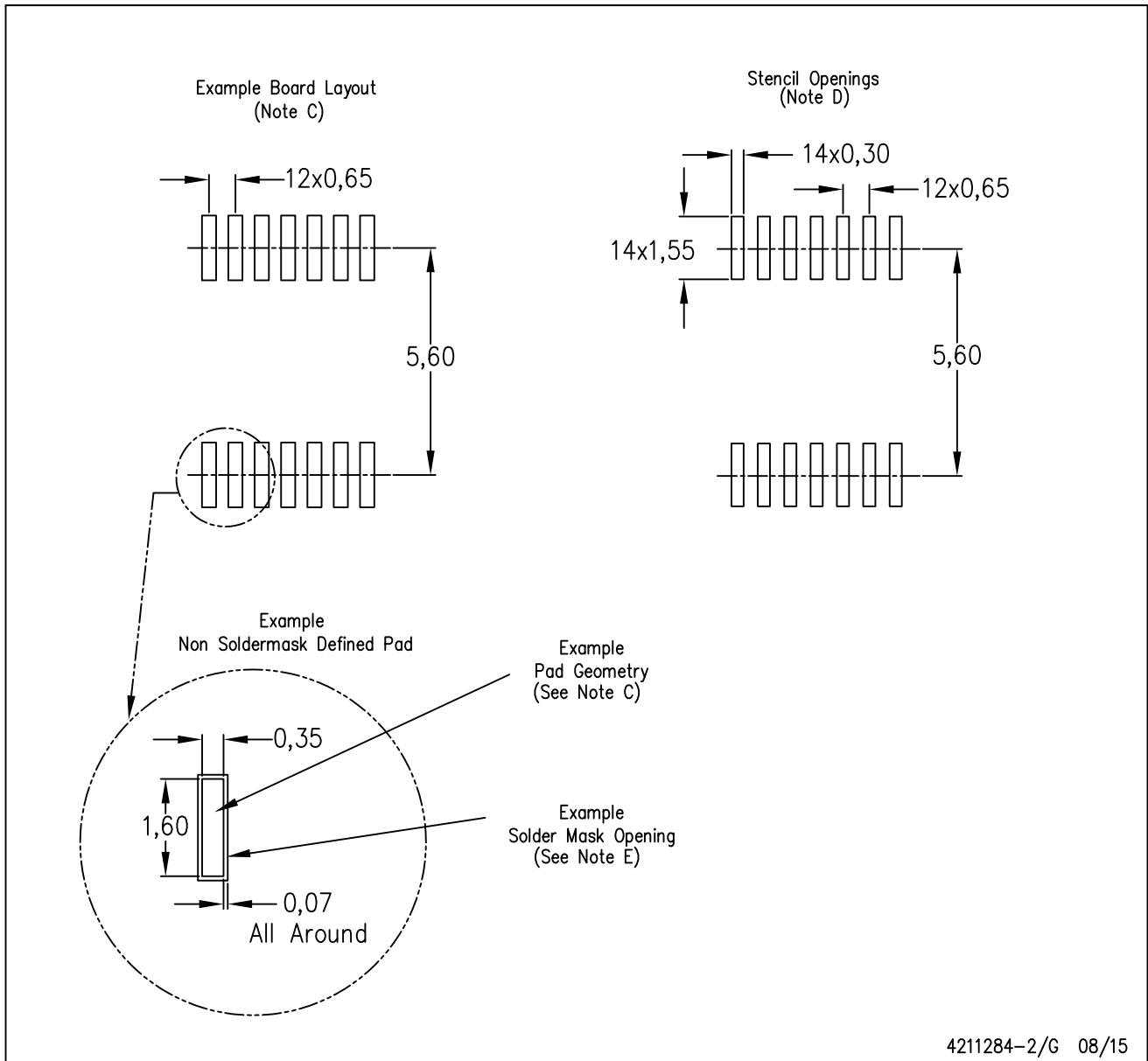

- NOTES:
- All linear dimensions are in millimeters.
 - This drawing is subject to change without notice.
 - Publication IPC-7351 is recommended for alternate designs.
 - Laser cutting apertures with trapezoidal walls and also rounding corners will offer better paste release. Customers should contact their board assembly site for stencil design recommendations. Refer to IPC-7525 for other stencil recommendations.
 - Customers should contact their board fabrication site for solder mask tolerances between and around signal pads.



D0008A

PACKAGE OUTLINE

SOIC - 1.75 mm max height

SMALL OUTLINE INTEGRATED CIRCUIT



4214825/C 02/2019

NOTES:

1. Linear dimensions are in inches [millimeters]. Dimensions in parenthesis are for reference only. Controlling dimensions are in inches. Dimensioning and tolerancing per ASME Y14.5M.
2. This drawing is subject to change without notice.
3. This dimension does not include mold flash, protrusions, or gate burrs. Mold flash, protrusions, or gate burrs shall not exceed $.006$ [0.15] per side.
4. This dimension does not include interlead flash.
5. Reference JEDEC registration MS-012, variation AA.

EXAMPLE BOARD LAYOUT

D0008A

SOIC - 1.75 mm max height

SMALL OUTLINE INTEGRATED CIRCUIT



LAND PATTERN EXAMPLE
 EXPOSED METAL SHOWN
 SCALE:8X



SOLDER MASK DETAILS

4214825/C 02/2019

NOTES: (continued)

- 6. Publication IPC-7351 may have alternate designs.
- 7. Solder mask tolerances between and around signal pads can vary based on board fabrication site.

EXAMPLE STENCIL DESIGN

D0008A

SOIC - 1.75 mm max height

SMALL OUTLINE INTEGRATED CIRCUIT



SOLDER PASTE EXAMPLE
BASED ON .005 INCH [0.125 MM] THICK STENCIL
SCALE:8X

4214825/C 02/2019

NOTES: (continued)

8. Laser cutting apertures with trapezoidal walls and rounded corners may offer better paste release. IPC-7525 may have alternate design recommendations.
9. Board assembly site may have different recommendations for stencil design.

JG (R-GDIP-T8)

CERAMIC DUAL-IN-LINE

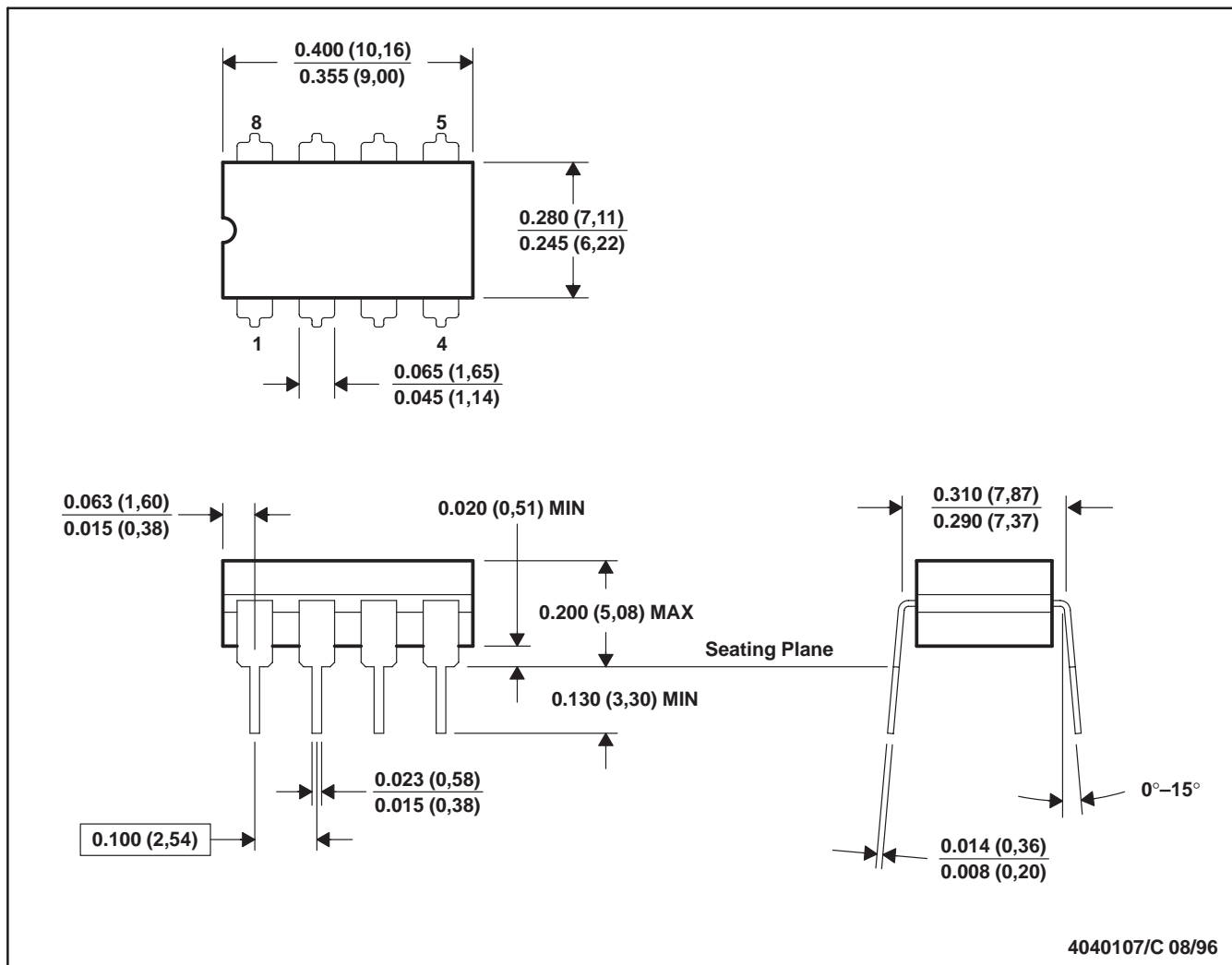

- NOTES: A. All linear dimensions are in inches (millimeters).
 B. This drawing is subject to change without notice.
 C. This package can be hermetically sealed with a ceramic lid using glass frit.
 D. Index point is provided on cap for terminal identification.
 E. Falls within MIL STD 1835 GDIP1-T8

P (R-PDIP-T8)

PLASTIC DUAL-IN-LINE PACKAGE

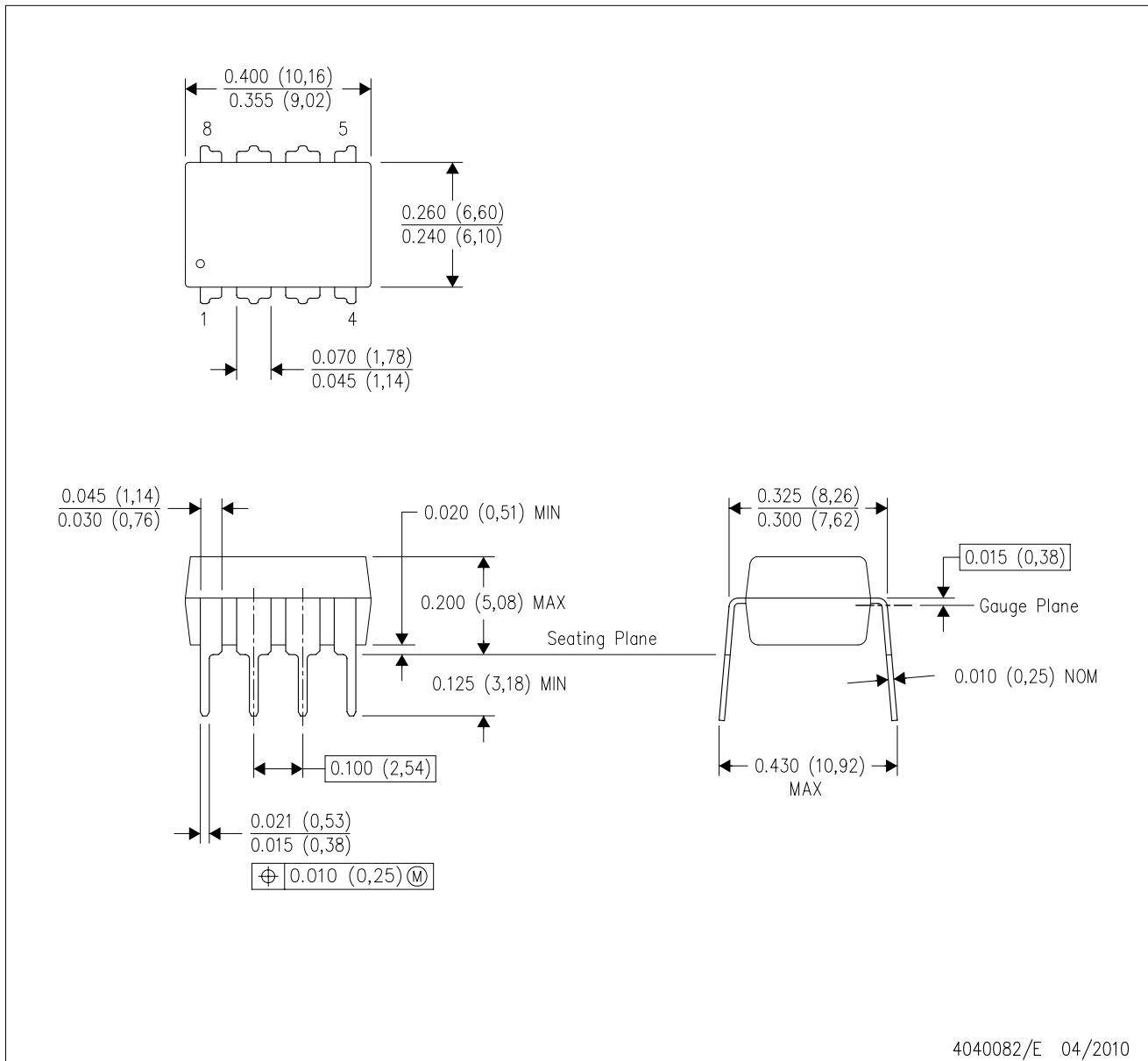

- NOTES:
- A. All linear dimensions are in inches (millimeters).
 - B. This drawing is subject to change without notice.
 - C. Falls within JEDEC MS-001 variation BA.

N (R-PDIP-T**)

PLASTIC DUAL-IN-LINE PACKAGE

16 PINS SHOWN

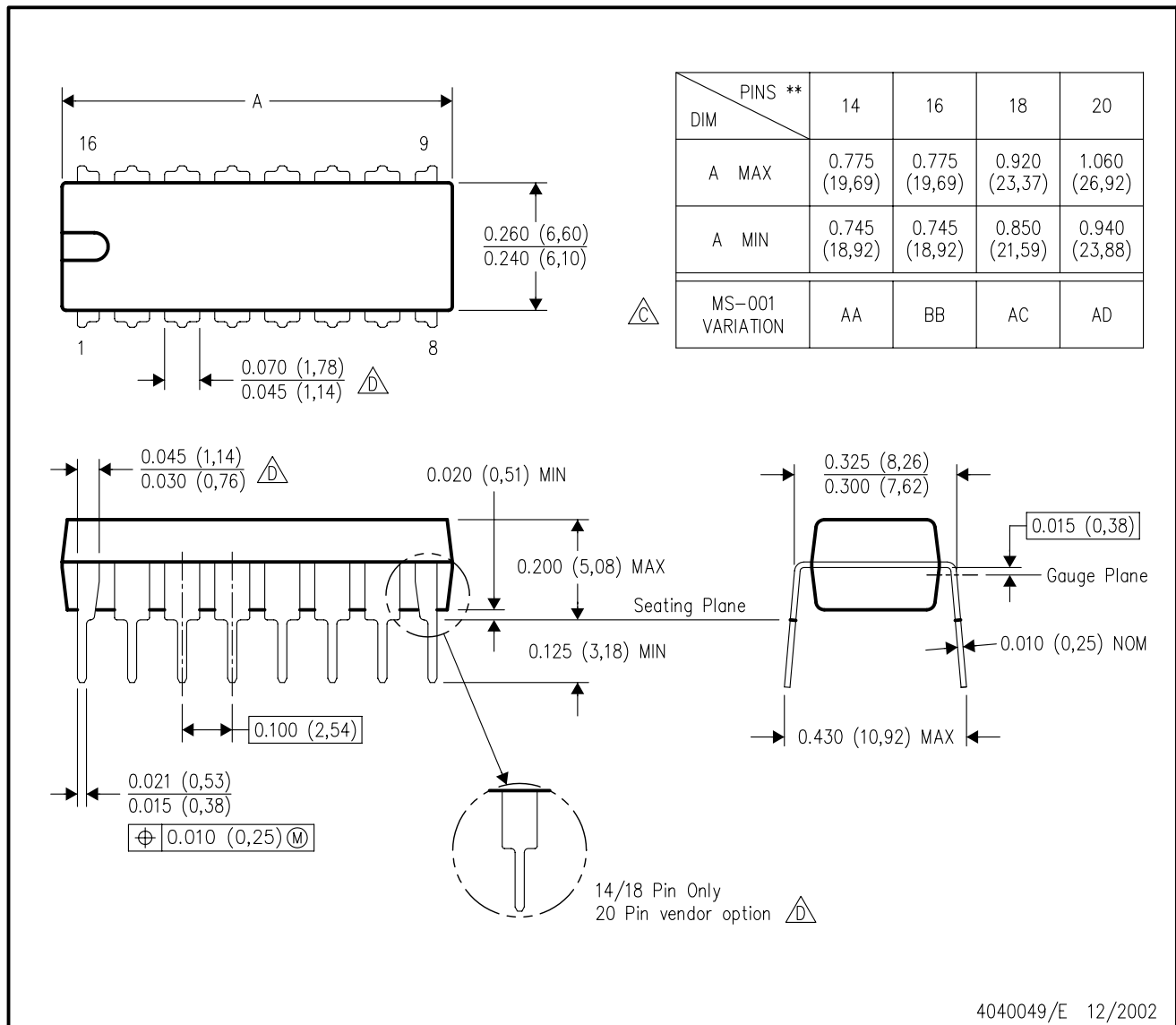

- NOTES:
- A. All linear dimensions are in inches (millimeters).
 - B. This drawing is subject to change without notice.
 - $\triangle C$ Falls within JEDEC MS-001, except 18 and 20 pin minimum body length (Dim A).
 - $\triangle D$ The 20 pin end lead shoulder width is a vendor option, either half or full width.

EXAMPLE BOARD LAYOUT

DBV0005A

SOT-23 - 1.45 mm max height

SMALL OUTLINE TRANSISTOR

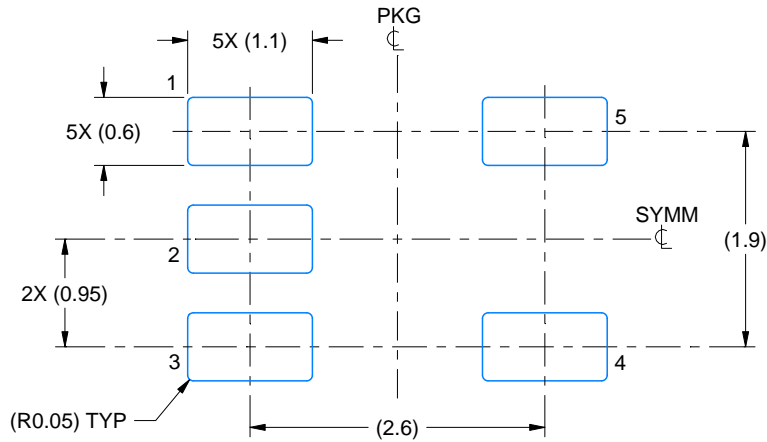

LAND PATTERN EXAMPLE
EXPOSED METAL SHOWN
SCALE:15X

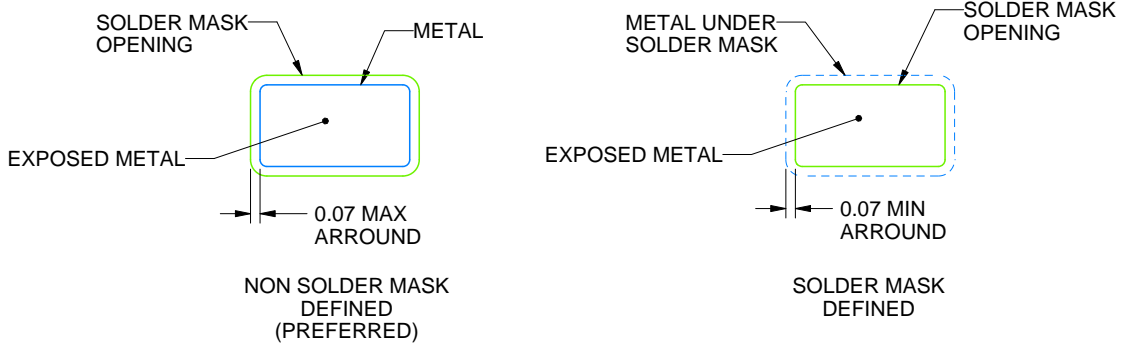

SOLDER MASK DETAILS

4214839/D 11/2018

NOTES: (continued)

- 5. Publication IPC-7351 may have alternate designs.
- 6. Solder mask tolerances between and around signal pads can vary based on board fabrication site.

EXAMPLE STENCIL DESIGN

DBV0005A

SOT-23 - 1.45 mm max height

SMALL OUTLINE TRANSISTOR

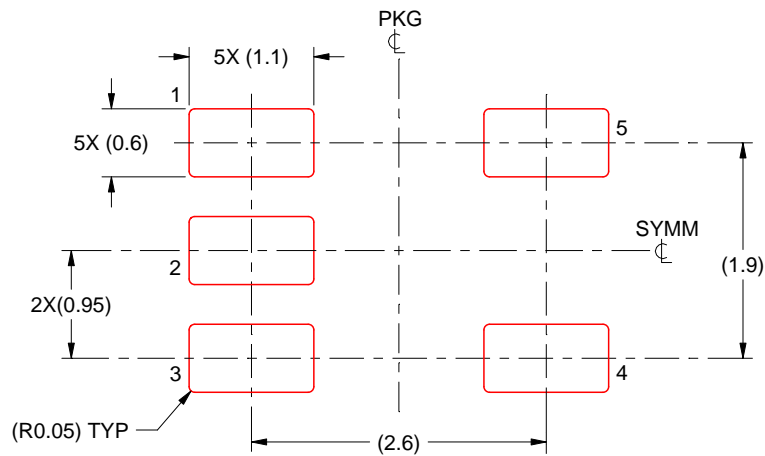

SOLDER PASTE EXAMPLE
BASED ON 0.125 mm THICK STENCIL
SCALE:15X

4214839/D 11/2018

NOTES: (continued)

7. Laser cutting apertures with trapezoidal walls and rounded corners may offer better paste release. IPC-7525 may have alternate design recommendations.
8. Board assembly site may have different recommendations for stencil design.

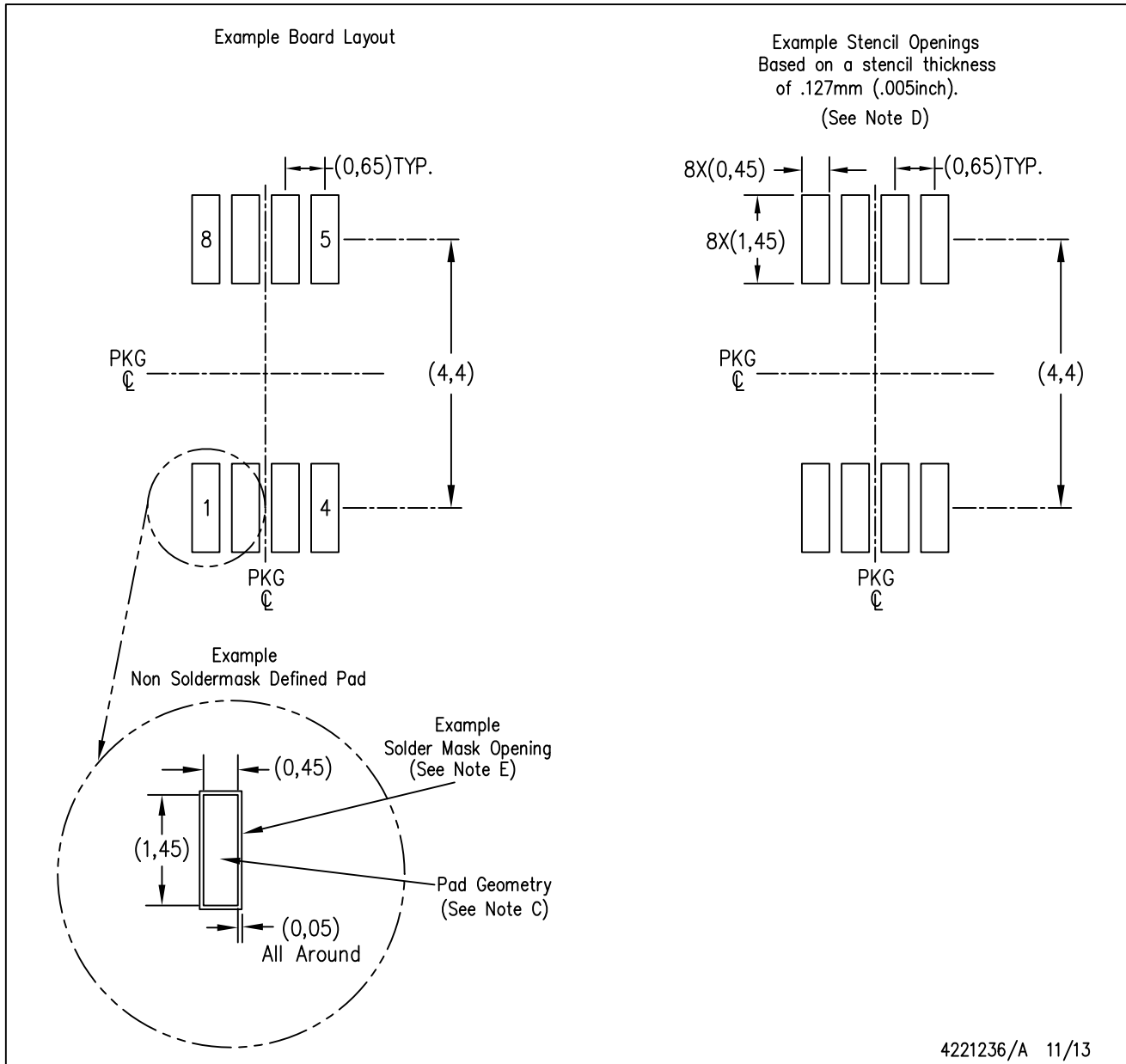

- NOTES:
- A. All linear dimensions are in millimeters.
 - B. This drawing is subject to change without notice.
 - C. Publication IPC-7351 is recommended for alternate designs.
 - D. Laser cutting apertures with trapezoidal walls and also rounding corners will offer better paste release. Customers should contact their board assembly site for stencil design recommendations. Refer to IPC-7525 for other stencil recommendations.
 - E. Customers should contact their board fabrication site for solder mask tolerances between and around signal pads.

PW0008A



PACKAGE OUTLINE
TSSOP - 1.2 mm max height

SMALL OUTLINE PACKAGE

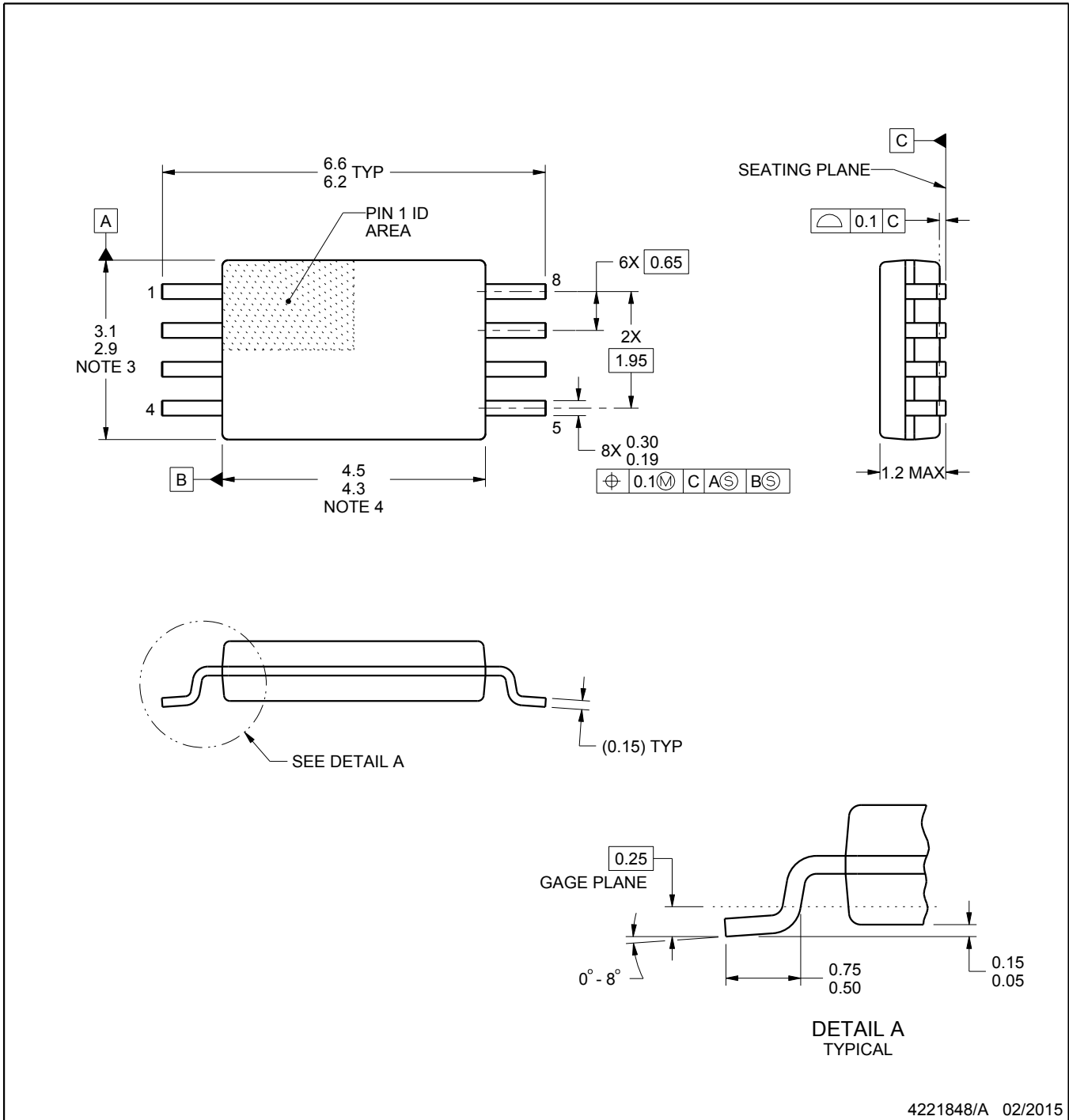

NOTES:

1. All linear dimensions are in millimeters. Any dimensions in parenthesis are for reference only. Dimensioning and tolerancing per ASME Y14.5M.
2. This drawing is subject to change without notice.
3. This dimension does not include mold flash, protrusions, or gate burrs. Mold flash, protrusions, or gate burrs shall not exceed 0.15 mm per side.
4. This dimension does not include interlead flash. Interlead flash shall not exceed 0.25 mm per side.
5. Reference JEDEC registration MO-153, variation AA.

EXAMPLE BOARD LAYOUT

PW0008A

TSSOP - 1.2 mm max height

SMALL OUTLINE PACKAGE



LAND PATTERN EXAMPLE
SCALE:10X

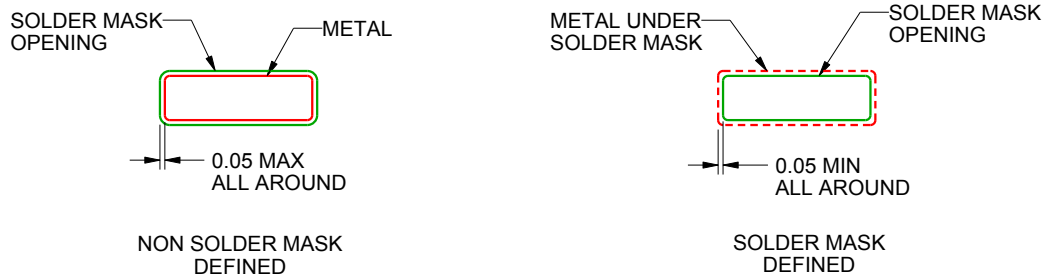

SOLDER MASK DETAILS
NOT TO SCALE

4221848/A 02/2015

NOTES: (continued)

- 6. Publication IPC-7351 may have alternate designs.
- 7. Solder mask tolerances between and around signal pads can vary based on board fabrication site.

EXAMPLE STENCIL DESIGN

PW0008A

TSSOP - 1.2 mm max height

SMALL OUTLINE PACKAGE



SOLDER PASTE EXAMPLE
BASED ON 0.125 mm THICK STENCIL
SCALE:10X

4221848/A 02/2015

NOTES: (continued)

8. Laser cutting apertures with trapezoidal walls and rounded corners may offer better paste release. IPC-7525 may have alternate design recommendations.
9. Board assembly site may have different recommendations for stencil design.

IMPORTANT NOTICE AND DISCLAIMER

TI PROVIDES TECHNICAL AND RELIABILITY DATA (INCLUDING DATASHEETS), DESIGN RESOURCES (INCLUDING REFERENCE DESIGNS), APPLICATION OR OTHER DESIGN ADVICE, WEB TOOLS, SAFETY INFORMATION, AND OTHER RESOURCES "AS IS" AND WITH ALL FAULTS, AND DISCLAIMS ALL WARRANTIES, EXPRESS AND IMPLIED, INCLUDING WITHOUT LIMITATION ANY IMPLIED WARRANTIES OF MERCHANTABILITY, FITNESS FOR A PARTICULAR PURPOSE OR NON-INFRINGEMENT OF THIRD PARTY INTELLECTUAL PROPERTY RIGHTS.

These resources are intended for skilled developers designing with TI products. You are solely responsible for (1) selecting the appropriate TI products for your application, (2) designing, validating and testing your application, and (3) ensuring your application meets applicable standards, and any other safety, security, or other requirements. These resources are subject to change without notice. TI grants you permission to use these resources only for development of an application that uses the TI products described in the resource. Other reproduction and display of these resources is prohibited. No license is granted to any other TI intellectual property right or to any third party intellectual property right. TI disclaims responsibility for, and you will fully indemnify TI and its representatives against, any claims, damages, costs, losses, and liabilities arising out of your use of these resources.

TI's products are provided subject to TI's Terms of Sale (www.ti.com/legal/termsofsale.html) or other applicable terms available either on ti.com or provided in conjunction with such TI products. TI's provision of these resources does not expand or otherwise alter TI's applicable warranties or warranty disclaimers for TI products.

Mailing Address: Texas Instruments, Post Office Box 655303, Dallas, Texas 75265
Copyright © 2019, Texas Instruments Incorporated

Looking for pricing, stock, or lifecycle information?

Click below to explore more details on WIN SOURCE:

 [View TLV2775CN](#) on WIN SOURCE

 [Texas Instruments](#) Information

Optimize Your Supply Chain with WIN SOURCE Solutions

-  Global Sourcing Solution
-  Obsolete Management
-  Cost Control Management
-  Shortage Management
-  Alternative Solution
-  Excess Inventory Management