

Chip tantalum capacitors (Fail-safe open structure type)

TCFG Series B Case

●Features

- 1) Safety design by open function built - in.
- 2) Wide capacitance range
- 3) Screening by thermal shock.

●Dimensions (Unit : mm)

(Unit : mm)	
Dimensions	Size
L	3.5±0.2
W ₁	2.8±0.2
W ₂	1.9±0.2
H	1.9±0.2
S	0.8±0.3

●Product No. Explanation

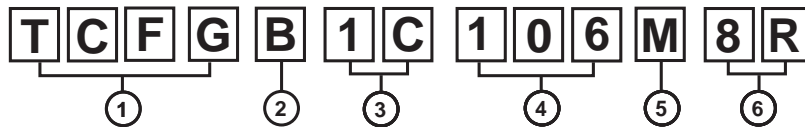

① Series name
TCFG

② Case code
B

③ Rated voltage

Rated voltage (V)	2.5	4	6.3	10	16	20	25
CODE	0E	0G	0J	1A	1C	1D	1E

④ Capacitance
Nominal capacitance in pF in 3 digits : 2significant figure representing the number of 0's.

⑤ Capacitance tolerance
M : ±20%

⑥ Taping
8 : Reel width (8mm)
R : Positive electrode on the side opposite to sprocket hole

●Capacitance range

(μF)	Rated voltage (V.DC)						
	2.5	4	6.3	10	16	20	25
3.3 (335)					B	B *	B
4.7 (475)				B	B	B	B
6.8 (685)				B	B	B *	
10 (106)			B	B	B	B *	
15 (156)		B	B	B	B		
22 (226)		B	B	B	B		
33 (336)		B	B	B	B		
47 (476)		B	B	B			
68 (686)		B	B	B			
100 (107)		B	B	B			
150 (157)		B	B	B			
220 (227)	B	B	B				
330 (337)	B *	B *					

Remark) Case size codes (B) in the above show each size products line-up.
 * : Under development

●Marking

The indications listed below should be given on the surface of a capacitor.

- ① Polarity : The polarity should be shown by □ bar. (on the anode side)
- ② Rated DC voltage : Due to the small size of A case, a voltage code is used as shown below.
- ③ Nominal capacitance

[B Case] note 1) Visual typical example (1) voltage code (2) capacitance code

10 16V
 (1) (2)

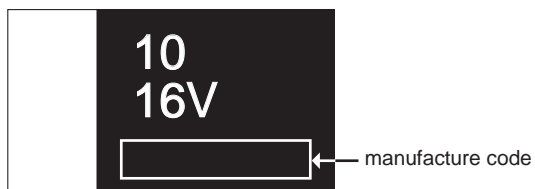

note 2) voltage code and capacitance code are variable with parts number

●Characteristics

Item		Performance	Test conditions (based on JIS C5101-1 and JIS C5101-3)															
Operating Temperature		-55 °C to +125 °C	Voltage reduction when temperature exceeds +85°C															
Maximum operating temperature with no voltage derating		+85 °C																
Rated Voltage (V.DC)		2.5 4 6.3 10 16 20 25	at 85°C															
Category Voltage (V.DC)		1.6 2.5 4 6.3 10 13 16	at 125°C															
Surge Voltage		3.2 5.0 8 13 20 26 32	at 85°C															
DC leakage current		0.5μA or 0.01CV whichever is greater (Shown in "Standard list")	As per 4.9 JIS C 5101-1 As per 4.5.1 JIS C 5101-3 Voltage : Rated voltage for 1 min															
Capacitance tolerance		Shall be satisfied allowance range. ±20%	As per 4.7 JIS C 5101-1 As per 4.5.2 JIS C 5101-3 Measuring frequency : 120±12Hz Measuring voltage : 0.5Vrms, +1.5V.DC Measuring circuit : DC Equivalent series circuit															
Tangent of loss angle (Df, tanδ)		Shall be satisfied the voltage on "Standard list"	As per 4.8 JIS C 5101-1 As per 4.5.3 JIS C 5101-3 Measuring frequency : 120±12Hz Measuring voltage : 0.5Vrms, +1.5V.DC Measuring circuit : DC Equivalent series circuit															
Impedance		Shall be satisfied the voltage on "Standard list"	As per 4.10 JIS C 5101-1 As per 4.5.4 JIS C 5101-3 Measuring frequency : 100±10kHz Measuring voltage : 0.5Vrms or less Measuring circuit : DC Equivalent series circuit															
Resistance to soldering heat	Appearance	There should be no significant abnormality. The indications should be clear.	As per 4.14 JIS C 5101-1 As per 4.6 JIS C 5101-3 Dip in the solder bath Solder temp : 260±5°C Duration : 5±0.5s Repetition : 1 After the specimens, leave it at room temperature for over 24h and then measure the sample.															
	L.C	TCFGB0G227M8R : Less than 150% of initial limit TCFGB0J227M8R : Less than 150% of initial limit TCFGB1A157M8R : Less than 150% of initial limit TCFGB1A107M8R : Less than 150% of initial limit TCFGB1E475M8R : Less than 150% of initial limit Others : Less than initial limit																
	ΔC / C	TCFGB0G227M8R : Within ±15% of initial value TCFGB0J227M8R : Within ±15% of initial value TCFGB1A157M8R : Within ±15% of initial value TCFGB1A107M8R : Within ±15% of initial value TCFGB1E475M8R : Within ±10% of initial value Others : Within ± 5% of initial value																
	tanδ	3.3 to 33μF : Less than initial limit 47 to 150μF : Less than 150% of initial limit TCFGB0E227M8R : Less than 200% of initial limit TCFGB0G227M8R : Less than 150% of initial limit TCFGB0J227M8R : Less than 150% of initial limit TCFGB1A157M8R : Less than 150% of initial limit TCFGB1A107M8R : Less than 150% of initial limit TCFGB1C336M8R : Less than 150% of initial limit																
Fail-Safe open unit actuation		Within 320°C – 20s	Dip in the solder bath Solder temp : 320±5°C															
Temperature cycle	Appearance	There should be no significant abnormality.	As per 4.16 JIS C 5101-1 As per 4.10 JIS C 5101-3 Repetition : 5 cycles (1 cycle : steps 1 to 4) without discontinuation. <table border="1"> <thead> <tr> <th>Step</th> <th>Temp.</th> <th>Time</th> </tr> </thead> <tbody> <tr> <td>1</td> <td>-55±3°C</td> <td>30±3min</td> </tr> <tr> <td>2</td> <td>Room temp.</td> <td>3min. or less</td> </tr> <tr> <td>3</td> <td>125±2°C</td> <td>30±3min</td> </tr> <tr> <td>4</td> <td>Room temp.</td> <td>3min. or less</td> </tr> </tbody> </table> After the specimens, leave it at room temperature for over 24h and then measure the sample.	Step	Temp.	Time	1	-55±3°C	30±3min	2	Room temp.	3min. or less	3	125±2°C	30±3min	4	Room temp.	3min. or less
	Step	Temp.		Time														
	1	-55±3°C		30±3min														
	2	Room temp.		3min. or less														
3	125±2°C	30±3min																
4	Room temp.	3min. or less																
L.C	TCFGB0G227M8R : Less than 150% of initial limit TCFGB0J227M8R : Less than 200% of initial limit TCFGB1A157M8R : Less than 200% of initial limit TCFGB1A107M8R : Less than 200% of initial limit TCFGB1E475M8R : Less than 150% of initial limit Others : Less than initial limit																	
ΔC / C	TCFGB0E227M8R : Within ±15% of initial value TCFGB0G227M8R : Within ±15% of initial value TCFGB0J227M8R : Within ±20% of initial value TCFGB1A157M8R : Within ±20% of initial value TCFGB1A107M8R : Within ±20% of initial value Others : Within ±10% of initial value																	
tanδ	3.3 to 33μF : Less than initial limit 47 to 150μF : Less than 150% of initial limit TCFGB0G227M8R : Less than 150% of initial limit TCFGB0J227M8R : Less than 200% of initial limit TCFGB1A157M8R : Less than 200% of initial limit TCFGB1A107M8R : Less than 200% of initial limit TCFGB1C336M8R : Less than 150% of initial limit																	
Moisture resistance	Appearance	There should be no significant abnormality. The indications should be clear.	As per 4.22 JIS C 5101-1 As per 4.12 JIS C 5101-3 After leaving the sample under such atmospheric condition that the temperature and humidity are 60±2°C and 90 to 95%RH, respectively, for 500±12h level it at room temperature for over 24h and then measure the sample.															
	L.C	TCFGB0G227M8R : Less than 150% of initial limit TCFGB0J227M8R : Less than 200% of initial limit TCFGB1A157M8R : Less than 200% of initial limit TCFGB1A107M8R : Less than 200% of initial limit TCFGB1E475M8R : Less than 150% of initial limit Others : Less than initial limit																
	ΔC / C	TCFGB0G227M8R : Within ±15% of initial value TCFGB0J227M8R : Within ±20% of initial value TCFGB1A157M8R : Within ±20% of initial value TCFGB1A107M8R : Within ±20% of initial value Others : Within ±10% of initial value																
	tanδ	3.3 to 33μF : Less than initial limit 47 to 150μF : Less than 150% of initial limit TCFGB0G227M8R : Less than 150% of initial limit TCFGB0J227M8R : Less than 200% of initial limit TCFGB1A157M8R : Less than 200% of initial limit TCFGB1A107M8R : Less than 200% of initial limit TCFGB1C336M8R : Less than 150% of initial limit																

Item	Performance	Test conditions (based on JIS C5101-1 and JIS C5101-3)
Temperature Stability	Temp.	-55°C
	ΔC / C	TCFGB0G227M8R : Within 0/-15% of initial value TCFGB0J227M8R : Within 0/-30% of initial value TCFGB1A157M8R : Within 0/-30% of initial value TCFGB1A107M8R : Within 0/-30% of initial value Others : Within 0/-12% of initial value
	tanδ	Shall be satisfied the value on Table5
	L.C	-
	Temp.	+85°C
	ΔC / C	TCFGB0G227M8R : Within +12/0% of initial value TCFGB0J227M8R : Within +15/0% of initial value TCFGB1A157M8R : Within +15/0% of initial value TCFGB1A107M8R : Within +15/0% of initial value Others : Within +10/0% of initial value
	tanδ	Shall be satisfied the value on Table5
	L.C	Less than 1000% of initial limit
	Temp.	+125°C
	ΔC / C	TCFGB0J227M8R : Within +20/0% of initial value TCFGB1A157M8R : Within +20/0% of initial value TCFGB1A107M8R : Within +20/0% of initial value TCFGB1C336M8R : Within +20/0% of initial value Others : Within +15/0% of initial value
Surge Voltage	Appearance	There should be no significant abnormality. The indications should be clear.
	L.C	TCFGB0G227M8R : Less than 150% of initial limit TCFGB0J227M8R : Less than 200% of initial limit TCFGB1A157M8R : Less than 200% of initial limit TCFGB1A107M8R : Less than 200% of initial limit TCFGB1E475M8R : Less than 150% of initial limit Others : Less than initial limit
	ΔC / C	TCFGB0E227M8R : Within ±12% of initial value TCFGB0G227M8R : Within ±15% of initial value TCFGB0J227M8R : Within ±20% of initial value TCFGB1A157M8R : Within ±20% of initial value TCFGB1A107M8R : Within ±20% of initial value Others : Within ±10% of initial value
	tanδ	3.3 to 33μF : Less than initial limit 47 to 150μF : Less than 150% of initial limit TCFGB0G227M8R : Less than 200% of initial limit TCFGB0J227M8R : Less than 200% of initial limit TCFGB1A157M8R : Less than 200% of initial limit TCFGB1A107M8R : Less than 200% of initial limit TCFGB1C336M8R : Less than 150% of initial limit
Loading at High temperature	Appearance	There should be no significant abnormality. The indications should be clear.
	L.C	TCFGB0E227M8R : Less than 125% of initial limit TCFGB0G227M8R : Less than 150% of initial limit TCFGB0J227M8R : Less than 200% of initial limit TCFGB1A157M8R : Less than 200% of initial limit TCFGB1A107M8R : Less than 200% of initial limit TCFGB1E475M8R : Less than 150% of initial limit Others : Less than initial limit
	ΔC / C	TCFGB0G227M8R : Within ±15% of initial value TCFGB0J227M8R : Within ±20% of initial value TCFGB1A157M8R : Within ±20% of initial value TCFGB1A107M8R : Within ±20% of initial value Others : Within ±10% of initial value
	tanδ	3.3 to 33μF : Less than initial limit 47 to 100μF : Less than 150% of initial limit TCFGB0E227M8R : Less than 150% of initial limit TCFGB0G227M8R : Less than 200% of initial limit TCFGB0J227M8R : Less than 200% of initial limit TCFGB1A157M8R : Less than 200% of initial limit TCFGB1A107M8R : Less than 200% of initial limit TCFGB1C336M8R : Less than 150% of initial limit

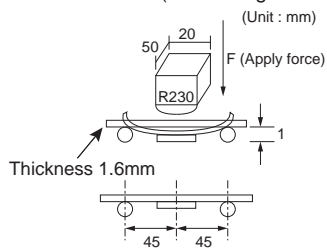
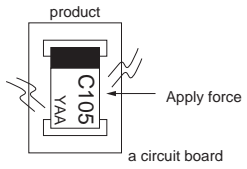
Item		Performance	Test conditions (based on JIS C5101-1 and JIS C5101-3)
Terminal Strength	Capacitance	The measured value should be stable.	As per 4.35 JIS C 5101-1 As per 4.9 JIS C 5101-3 A force is applied to the terminal until it bends to 1mm and by a prescribed tool maintain the condition for 5s. (See the figure below.) (Unit : mm) 
	Appearance	There should be no significant abnormality.	
Adhesiveness		The terminal should not come off.	As per 4.34 JIS C 5101-1 As per 4.8 JIS C 5101-3 Apply force of 5N in the two directions shown in the figure below for 10±1s after mounting the terminal on a circuit board. 
Dimensions		Be based on "External dimensions"	Measure using a caliper of JIS B 7505 Class 2 or higher grade.
Resistance to solvents		The indication should be clear.	As per 4.32 JIS C 5101-1 As per 4.18 JIS C 5101-3 Dip in the isopropyl alcohol for 30±5s, at room temperature.
Solderability		3/4 or more surface area of the solder coated terminal dipped in the soldering bath should be covered with the new solder.	As per 4.15.2 JIS C 5101-1 As per 4.7 JIS C 5101-3 Dip speed = 25±2.5mm/s Pre-treatment (accelerated aging) : Leave the sample on the boiling distilled water for 1h. Solder temp. : 245±5°C Duration : 3±0.5s Solder : M705 Flux : Rosin 25%, IPA 75%
Vibration	Capacitance	Measure value should not fluctuate during the measurement.	As per 4.17 JIS C 5101-1 Frequency : 10 to 55 to 10Hz/min. Amplitude : 1.5mm Time : 2h each in X and Y directions Mounting : The terminal is soldered on a print circuit board.
	Appearance	There should be no significant abnormality.	

●Standard list, TCFG series B Cases

Part No.	Rated Voltage @85°C (V)	Derated Voltage @125°C (V)	Surge Voltage @85°C (V)	Capacitance 120Hz (μF)	Tolerance (%)	Leakage current 25°C 1WV.60s (μA)	DF 120Hz (%)			Impedance 100kHz (Ω)	Case code
							-55°C	25°C 85°C	125°C		
TCFG B 0E 227 M8R	2.5	1.6	3.2	220	±20	5.5	34	18	22	1.5	B
TCFG B 0G 156 M8R	4	2.5	5	15	±20	0.6	12	8	10	3.0	B
TCFG B 0G 226 M8R	4	2.5	5	22	±20	0.9	12	8	10	3.0	B
TCFG B 0G 336 M8R	4	2.5	5	33	±20	1.3	12	8	10	2.5	B
TCFG B 0G 476 M8R	4	2.5	5	47	±20	1.9	14	10	12	2.0	B
TCFG B 0G 686 M8R	4	2.5	5	68	±20	2.7	14	10	12	1.9	B
TCFG B 0G 107 M8R	4	2.5	5	100	±20	4.0	30	12	16	1.6	B
TCFG B 0G 157 M8R	4	2.5	5	150	±20	6.3	34	18	22	1.3	B
TCFG B 0G 227 M8R	4	2.5	5	220	±20	8.8	40	20	30	1.3	B
TCFG B 0J 106 M8R	6.3	4	8	10	±20	0.6	12	8	10	3.0	B
TCFG B 0J 156 M8R	6.3	4	8	15	±20	0.9	12	8	10	3.0	B
TCFG B 0J 226 M8R	6.3	4	8	22	±20	1.4	12	8	10	2.5	B
TCFG B 0J 336 M8R	6.3	4	8	33	±20	2.1	12	8	10	2.0	B
TCFG B 0J 476 M8R	6.3	4	8	47	±20	3.0	14	10	12	1.9	B
TCFG B 0J 686 M8R	6.3	4	8	68	±20	4.3	30	12	16	1.6	B
TCFG B 0J 107 M8R	6.3	4	8	100	±20	6.3	30	12	16	1.5	B
TCFG B 0J 157 M8R	6.3	4	8	150	±20	9.5	34	18	22	1.5	B
TCFG B 0J 227 M8R	6.3	4	8	220	±20	70	60	30	45	1.3	B
TCFG B 1A 475 M8R	10	6.3	13	4.7	±20	0.5	10	6	8	3.0	B
TCFG B 1A 685 M8R	10	6.3	13	6.8	±20	0.7	12	8	10	3.0	B
TCFG B 1A 106 M8R	10	6.3	13	10	±20	1.0	12	8	10	3.0	B
TCFG B 1A 156 M8R	10	6.3	13	15	±20	1.5	12	8	10	2.5	B
TCFG B 1A 226 M8R	10	6.3	13	22	±20	2.2	12	8	10	2.0	B
TCFG B 1A 336 M8R	10	6.3	13	33	±20	3.3	14	10	12	1.9	B
TCFG B 1A 476 M8R	10	6.3	13	47	±20	4.7	14	10	12	1.6	B
TCFG B 1A 686 M8R	10	6.3	13	68	±20	6.8	22	12	14	1.5	B
TCFG B 1A 107 M8R	10	6.3	13	100	±20	20	40	20	30	1.5	B
TCFG B 1C 335 M8R	16	10	20	3.3	±20	0.5	10	6	8	4.2	B
TCFG B 1C 475 M8R	16	10	20	4.7	±20	0.8	10	6	8	3.0	B
TCFG B 1C 685 M8R	16	10	20	6.8	±20	1.1	10	6	8	3.0	B
TCFG B 1C 106 M8R	16	10	20	10	±20	1.6	10	6	8	2.5	B
TCFG B 1C 156 M8R	16	10	20	15	±20	2.4	10	6	8	2.0	B
TCFG B 1C 226 M8R	16	10	20	22	±20	3.5	10	6	8	1.9	B
TCFG B 1C 336 M8R	16	10	20	33	±20	5.3	16	14	16	1.9	B
TCFG B 1D 335 M8R	20	13	26	3.3	±20	0.66	10	6	8	4.2	B
* TCFG B 1D 475 M8R	20	13	26	4.7	±20	1.0	10	6	8	3.0	B
* TCFG B 1D 106 M8R	20	13	26	10	±20	2.0	12	8	10	15.0	B
TCFG B 1E 335 M8R	25	16	32	3.3	±20	0.83	10	6	8	4.2	B
TCFG B 1E 475 M8R	25	16	32	4.7	±20	1.2	10	6	8	3.0	B

* = Under development

●Packaging specifications

(Unit : mm)

Case code	A±0.1	B±0.1	t ₁ ±0.05	t ₂ ±0.1
B (3528)	3.3	3.8	0.25	2.2

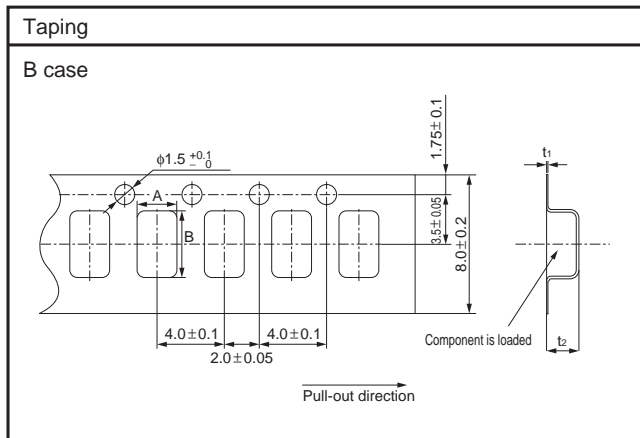

●Packaging style

Case code	Packaging	Packaging style		Symbol	Basic ordering unit
B Case	Taping	Plastic taping	φ180mm reel	8R	2,000

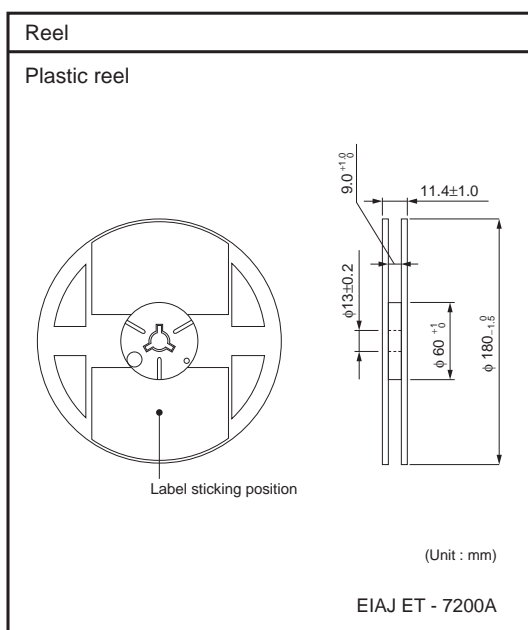

Notes

No copying or reproduction of this document, in part or in whole, is permitted without the consent of ROHM Co.,Ltd.

The content specified herein is subject to change for improvement without notice.

The content specified herein is for the purpose of introducing ROHM's products (hereinafter "Products"). If you wish to use any such Product, please be sure to refer to the specifications, which can be obtained from ROHM upon request.

Examples of application circuits, circuit constants and any other information contained herein illustrate the standard usage and operations of the Products. The peripheral conditions must be taken into account when designing circuits for mass production.

Great care was taken in ensuring the accuracy of the information specified in this document. However, should you incur any damage arising from any inaccuracy or misprint of such information, ROHM shall bear no responsibility for such damage.

The technical information specified herein is intended only to show the typical functions of and examples of application circuits for the Products. ROHM does not grant you, explicitly or implicitly, any license to use or exercise intellectual property or other rights held by ROHM and other parties. ROHM shall bear no responsibility whatsoever for any dispute arising from the use of such technical information.

The Products specified in this document are intended to be used with general-use electronic equipment or devices (such as audio visual equipment, office-automation equipment, communication devices, electronic appliances and amusement devices).

The Products specified in this document are not designed to be radiation tolerant.

While ROHM always makes efforts to enhance the quality and reliability of its Products, a Product may fail or malfunction for a variety of reasons.

Please be sure to implement in your equipment using the Products safety measures to guard against the possibility of physical injury, fire or any other damage caused in the event of the failure of any Product, such as derating, redundancy, fire control and fail-safe designs. ROHM shall bear no responsibility whatsoever for your use of any Product outside of the prescribed scope or not in accordance with the instruction manual.

The Products are not designed or manufactured to be used with any equipment, device or system which requires an extremely high level of reliability the failure or malfunction of which may result in a direct threat to human life or create a risk of human injury (such as a medical instrument, transportation equipment, aerospace machinery, nuclear-reactor controller, fuel-controller or other safety device). ROHM shall bear no responsibility in any way for use of any of the Products for the above special purposes. If a Product is intended to be used for any such special purpose, please contact a ROHM sales representative before purchasing.

If you intend to export or ship overseas any Product or technology specified herein that may be controlled under the Foreign Exchange and the Foreign Trade Law, you will be required to obtain a license or permit under the Law.



Thank you for your accessing to ROHM product informations.
More detail product informations and catalogs are available, please contact us.



ROHM Customer Support System

<http://www.rohm.com/contact/>



Looking for pricing, stock, or lifecycle information?

Click below to explore more details on WIN SOURCE:

-  [View TCFGB1C156M8R on WIN SOURCE](#)
-  [Rohm Semiconductor](#) Information

Optimize Your Supply Chain with WIN SOURCE Solutions

-  Global Sourcing Solution
-  Obsolete Management
-  Cost Control Management
-  Shortage Management
-  Alternative Solution
-  Excess Inventory Management