

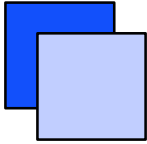

**THE DATASHEET OF  
ALD414012PJ126**





**DC-DC Converter Unit ALD-series: Brochure**

1 Name of ALD-series

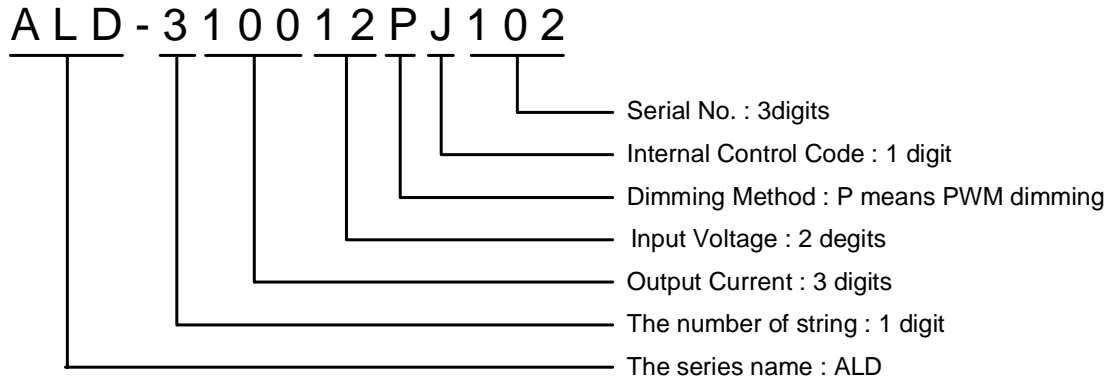

2 ALD-series Specification Parametric Table

Item Name	# of Strings	Input Voltage (Vdc)	Output Current (mA)	Burst Freq. (Hz)	Dimming		Vopen max (V)	Dimensions
					Analog (V)	PWM DC(V)		
ALD-214012PJ111	2	10.8~13.2	140	150	2.5~0	2.5~0	44	85.0(typ.)x21.5(typ.)x5.0(max)
ALD-310012PJ125	3	10.8~13.2	100	220	*1	0~2.5	42	85.0(typ.)x21.5(typ.)x5.5(max)
ALD-414012PJ126	4	10.8~13.2	140	150	2.5~0	2.5~0	44	100.0(typ.)x50.0(typ.)x5.2(max)
ALD-514012PJ127	5	10.8~13.2	140	150	2.5~0	2.5~0	44	100.0(typ.)x50.0(typ.)x5.2(max)

\*1 Though we recommend resistor dimming(Rbr), Analog amplitude dimming is acceptable in the 0V to 4V range.

Product Name	Input Connector	Corresponding	Vendor	Output Connector	Corresponding	vendor
ALD-214012PJ111	SM08B-SRSS-TB	SHR-08V-S-B	JST	SM06B-SRSS-TB	SHR-06V-S-B	JST
ALD-310012PJ125	53261-0871	51021-0800	molex	SM06B-SRSS-TB	SHR-06V-S-B	JST
ALD-414012PJ126	SM14B-SRSS-TB	SHR-14V-S-B	JST	SM10B-SRSS-TB	SHR-10V-S-B	JST
ALD-514012PJ127	SM14B-SRSS-TB	SHR-14B-S-B	JST	SM10B-SRSS-TB	SHR-10V-S-B	JST

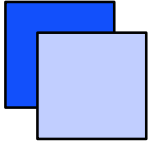

**DC-DC Converter Unit ALD-series: Brochure**

**3 ALD-series Common Functions**

- Built in circuit protector.
- Over voltage protection funtion.
- Alarm signal output fuction.
- Combined dimming is available.(Analog dimming and PWM burst dimming)

**4 Absolute Maximum Ratings**

**4-1 ALD-214012PJ111, ALD-414012PJ126, ALD-514012PJ127**

Item	Symbol	Specification	Unit	Notes
Input Voltage	Vin	13.2	Vdc	
	Vrmt	Vin	Vdc	
	Vbr	0 ~ 5	Vdc	
	ADIM	0 ~ 3	Vdc	
	Vst	This terminal is output terminal. Don't apply external voltage.		
Operating Temp. Range	Ta	-30 ~ 85	degC	
Storage Temp. Range	Ts	-40 ~ 85	degC	
Maximum Humidity	RH	95	%RH	A maximum wet ball temp is 38 degC. No dew.

**4-2 ALD-310012PJ125**

Item	Symbol	Specification	Unit	Notes
Input Voltage	Vin	13.2	Vdc	
	Vrmt	Vin	Vdc	
	Vbr	0 ~ 2.5	Vdc	
Operating Temp. Range	Ta	-30 ~ 80	degC	
Storage Temp. Range	Ts	-40 ~ 85	degC	
Maximum Humidity	RH	95	%RH	A maximum wet ball temp is 38 degC. No dew.



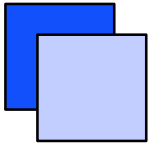

## DC-DC Converter Unit ALD-series: Brochure

Fig.5-3 ALD-414012PJ126, ALD-514012PJ127

Top View

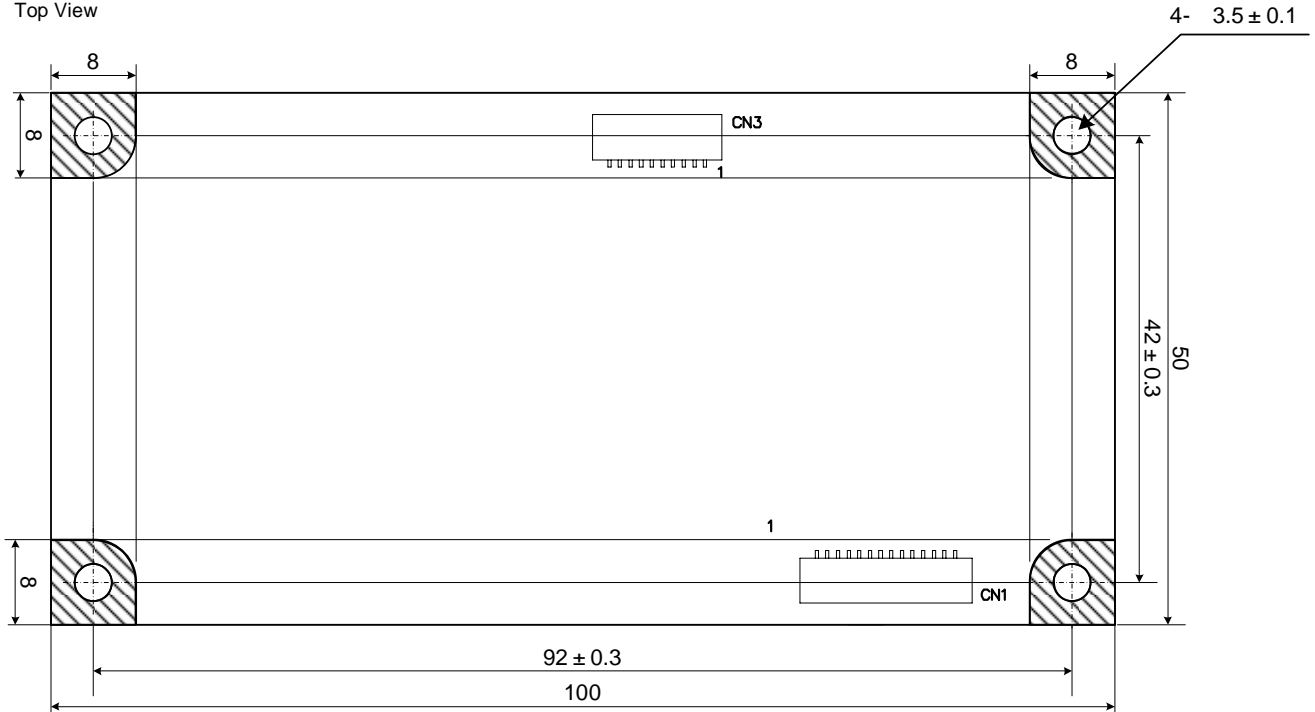

Bottom View

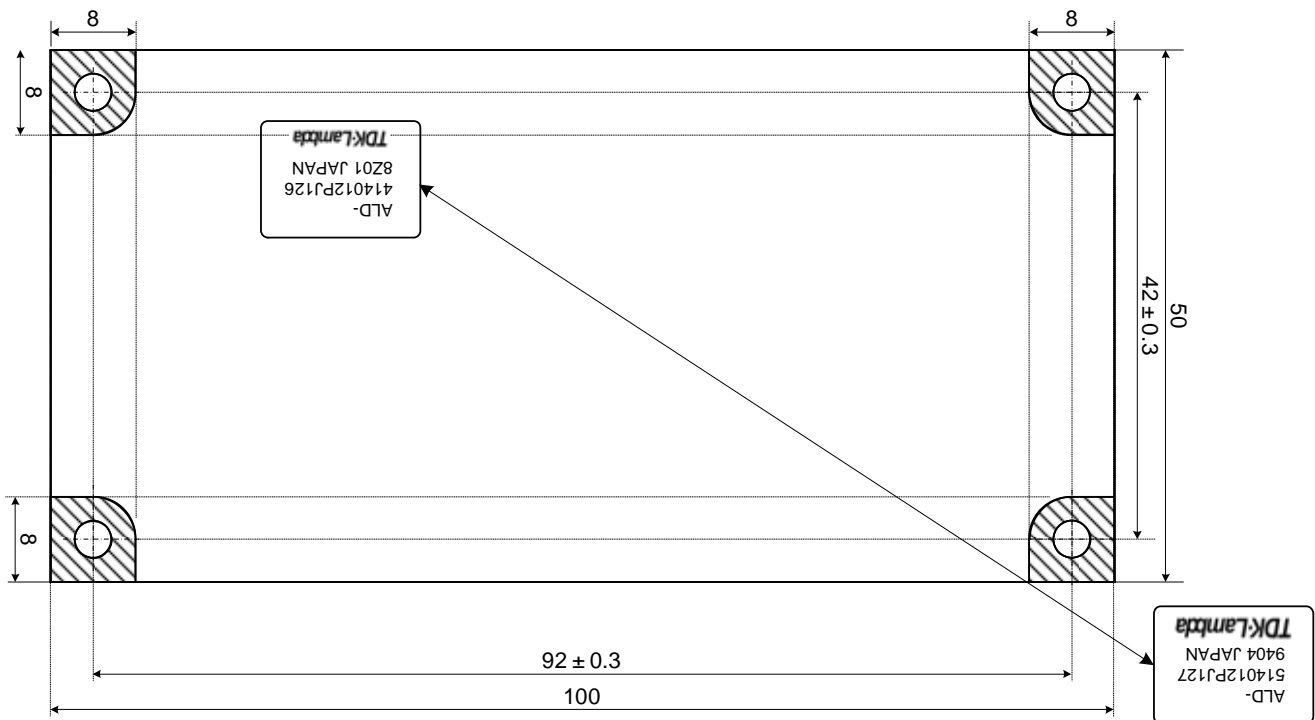

 Component and pattern prohibited area, except for GND pattern.  
tolerance is  $\pm 0.5\text{mm}$  unless otherwise specified.

unit in mm

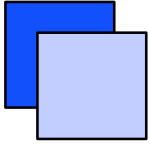

## 6 Pin Configuration

### 6-1 Input Connector Configuration

ALD series have different pin configuration for each model.

#### 6-1-1 ALD-214012PJ111

CN1: SM08B-SRSS-TB /JST

Pin	Symbol	Specification	Note
CN1-1	Vin	10.8~13.2(Vdc)	Input Voltage
CN1-2			
CN1-3	GND	0(V)	GND
CN1-4			
CN1-5	Vrmt	0~0.4(Vdc) : OFF 2.5~Vin(Vdc): ON	ON/OFF Control
CN1-6	Vbr	0~2.5(Vdc)	PWM dimming*1
	Rbr	0~50(kΩ)	
CN1-7	ADIM	0~2.5(Vdc)	Analog dimming*2
CN1-8	Vst (Output)	0(V) / 5(Vdc)	Alarm output*3

\*1 PWM dimming max. brightness is Vbr=0V or Rbr=0Ω. PWM dimming min. brightness is Vbr=2.5V or Rbr=50kΩ.

\*2 Analog dimming max. brightness is ADIM=0V and dimming min. brightness is ADIM=2.5V.

\*3 Alarm output is 0V at normal operation and 5V at abnormal operation.

#### 6-1-2 ALD-310012PJ125

CN1: 53261-0871 / MOLEX

Pin	Symbol	Specification	Note
CN1-1	Vin	10.8~13.2(Vdc)	Input Voltage
CN1-2			
CN1-3	GND	0(V)	GND
CN1-4			
CN1-5	Vrmt	0~0.4(Vdc) : OFF 2.5~Vin(Vdc): ON	ON/OFF Control
CN1-6	Vbr	0~2.5(Vdc)	PWM dimming*4
	Rbr1	0~10(kΩ)	
	PWM	0(V) : OFF / 3.3(V) : ON	
CN1-7	Rbr2	0~10(kΩ)	Analog dimming*5
CN1-8	Vst (Output)	0(V) / 5(Vdc)	Alarm output*6

\*4 PWM dimming max. brightness is Vbr=2.5V or Rbr=10kΩ. PWM dimming min. brightness is Vbr=0V, Rbr=0Ω. PWM pulse is acceptable, High active and low inactive.

\*5 Resistor dimming max. brightness is Rbr2=10kΩ. Resistor dimming min. brightness is Rbr2=0Ω. Also external DC voltage is acceptable.

Analog dimming max. brightness is Rbr=0V. Analog dimming min. brightness is Rbr=4V.

\*6 Alarm output is 0V at normal operation and 5V at abnormal operation.

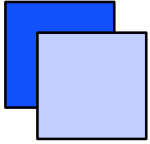

6-1-3 ALD-414012PJ126, ALD-514012PJ127

CN1: SM14B-SRSS-TB /JST

Pin	Symbol	Specification	Note
CN1-1			
CN1-2			
CN1-3	Vin	10.8~13.2(Vdc)	Input Voltage
CN1-4			
CN1-5			
CN1-6			
CN1-7			
CN1-8	GND	0(V)	GND
CN1-9			
CN1-10			
CN1-11	Vrmt	0~0.4(Vdc) : OFF 2.5~Vin(Vdc): ON	ON/OFF Control
CN1-12	Vbr Rbr	0~2.5(Vdc) 0~50(kΩ)	PWM dimming*7
CN1-13	ADIM	0~2.5(Vdc)	Analog dimming*8
CN1-14	Vst (Output)	0(V) / 5(Vdc)	Alarm output*9

\*7 PWM dimming max. brightness is Vbr=0V or Rbr=0Ω. PWM dimming min. brightness is Vbr=2.5V or Rbr=50kΩ.

\*8 Analog dimming max. brightness is ADIM=0V. Analog dimming min. brightness is ADIM=2.5V.

\*9 Alarm output is 0V at normal operation and 5V at abnormal operation.

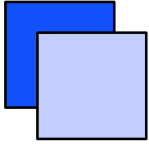

**DC-DC Converter Unit ALD-series: Brochure**

---

**6-2 Output Connector Configuration**

ALD series have different pin configuration for each model.

**6-2-1 ALD-214012PJ111**

CN3: SM06B-SRSS-1 /JST

Pin	Symbol	Note
CN3-1	LED_C2	line2-cathode side
CN3-2	LED_A2	line2-anode side
CN3-3	LED_A1	line1-anode side
CN3-4	LED_C1	line1-cathode side
CN3-5	N.C.	Not connected
CN3-6	N.A.	Tie to GND internally

**6-2-2 ALD-310012PJ125**

CN2: SM06B-SRSS-1 /JST

Pin	Symbol	Note
CN2-1	LED_A3	line3-anode side
CN2-2	LED_A2	line2-anode side
CN2-3	LED_A1	line1-anode side
CN2-4	LED_C1	line1-cathode side
CN2-5	LED_C2	line2-cathode side
CN2-6	LED_C3	line3-cathode side

**6-2-3 ALD-414012PJ126**

CN3: SM10B-SRSS-1 /JST

Pin	Symbol	Note
CN3-1	LED_C4	line4-cathode side
CN3-2	LED_A4	line4-anode side
CN3-3	LED_A3	line3-anode side
CN3-4	LED_C3	line3-cathode side
CN3-5	LED_C2	line2-cathode side
CN3-6	LED_A2	line2-anode side
CN3-7	LED_A1	line1-anode side
CN3-8	LED_C1	line1-cathode side
CN3-9	N.C.	Not Connected
CN3-10	N.C.	Not Connected

**6-2-4 ALD-514012PJ127**

CN3: SM10B-SRSS-1 /JST

Pin	Symbol	Note
CN3-1	LED_C5	line5-cathode side
CN3-2	LED_A5	line5-anode side
CN3-3	LED_A4	line4-anode side
CN3-4	LED_C4	line4-cathode side
CN3-5	LED_C3	line3-cathode side
CN3-6	LED_A3	line3-anode side
CN3-7	LED_A2	line2-anode side
CN3-8	LED_C2	line2-cathode side
CN3-9	LED_C1	line1-cathode side
CN3-10	LED_A1	line1-anode side

## Looking for pricing, stock, or lifecycle information?

Click below to explore more details on WIN SOURCE:

- ⊖ [View ALD414012PJ126 on WIN SOURCE](#)
- ⊖ [TDK-Lambda Americas Inc. Information](#)

## Optimize Your Supply Chain with WIN SOURCE Solutions

- ✓ Global Sourcing Solution
- ✓ Obsolete Management
- ✓ Cost Control Management
- ✓ Shortage Management
- ✓ Alternative Solution
- ✓ Excess Inventory Management