



# THE DATASHEET OF CDRH5D16NP-8R2NC



# SMD Power Inductor CDRH5D16



Halogen Free

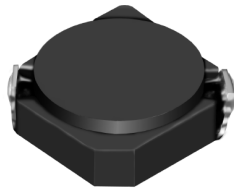

## Description

- Ferrite drum core construction.
- Magnetically shielded.
- L × W × H: 5.8 × 5.8 × 1.8 mm Max.
- Product weight: 1.88mg(Ref.)
- Moisture Sensitivity Level: 1
- RoHS compliance.
- Halogen Free available.

## Environmental Data

- Operating temperature range: -40°C~+105°C (including coil's self temperature rise)
- Storage temperature range: -40°C~+105°C
- Solder reflow temperature: 260 °C peak.

## Packaging

- Carrier tape and reel packaging
- 7.0" diameter reel
- 1000pcs per reel

## Applications

- Ideally used in Mobile phone, Notebook PC, MP3, PDA, HDD, DSC/DVC, Game machine, etc. as DC-DC converter inductors.

## Dimension - [mm]

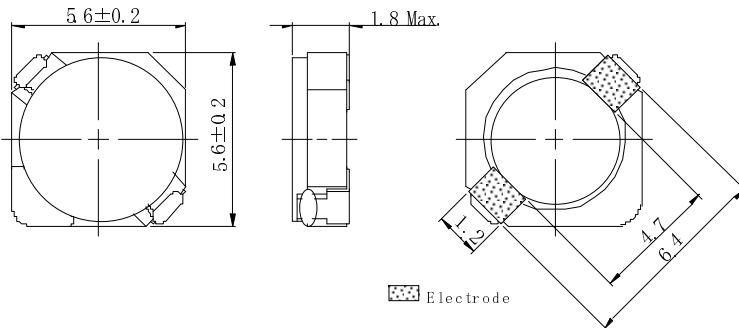

## Land pattern and Schematics - [mm]

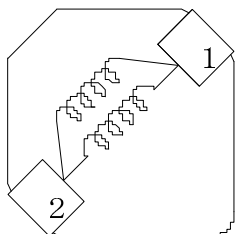
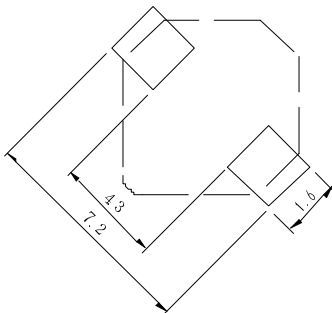

(0.90 μH ~ 10.0 μH)

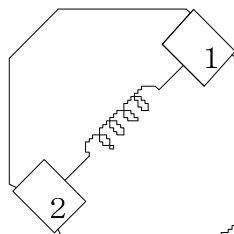

(15.0 μH ~ 100 μH)

# SMD Power Inductor CDRH5D16



## Electrical Characteristics

Part Name	Stamp	Inductance ( $\mu$ H) [within] ※1	D.C.R.( $\Omega$ ) [Max.] (Typ.) (at 20°C)	Saturation Current (A) ※2		Temperature Rise Current (A) ※3
				at 20°C	at 105°C	
CDRH5D16NP-0R9NC	0R9	0.90 $\pm$ 25%	14.6m(11.7m)	4.70	3.90	4.70
CDRH5D16NP-2R2NC	2R2	2.2 $\pm$ 25%	35.9m(28.7m)	3.00	2.45	2.90
CDRH5D16NP-3R3NC	3R3	3.3 $\pm$ 25%	44.5m(35.6m)	2.60	2.15	2.40
CDRH5D16NP-4R7NC	4R7	4.7 $\pm$ 25%	64.1m(51.3m)	2.15	1.75	2.10
CDRH5D16NP-6R8NC	6R8	6.8 $\pm$ 25%	84.3m(67.4m)	1.80	1.45	1.70
CDRH5D16NP-8R2NC	8R2	8.2 $\pm$ 25%	0.11(89.7m)	1.55	1.25	1.50
CDRH5D16NP-100MC	100	10.0 $\pm$ 20%	0.14(0.11)	1.45	1.15	1.30
CDRH5D16NP-150MC	150	15.0 $\pm$ 20%	0.20(0.16)	1.15	0.95	1.10
CDRH5D16NP-220MC	220	22.0 $\pm$ 20%	0.32(0.25)	0.95	0.80	0.80
CDRH5D16NP-330MC	330	33.0 $\pm$ 20%	0.44(0.35)	0.80	0.65	0.70
CDRH5D16NP-470MC	470	47.0 $\pm$ 20%	0.58(0.46)	0.68	0.52	0.60
CDRH5D16NP-680MC	680	68.0 $\pm$ 20%	0.86(0.69)	0.55	0.44	0.50
CDRH5D16NP-820MC	820	82.0 $\pm$ 20%	1.06(0.85)	0.50	0.40	0.42
CDRH5D16NP-101MC	101	100 $\pm$ 20%	1.41(1.13)	0.45	0.35	0.35

※1. Inductance measuring condition: at 100kHz.

※2. Saturation current: The value of D.C. current when the inductance decreases to 65% of it's nominal value.

※3. Temperature rise current: The value of D.C. current when the temperature rise is  $\Delta t=40^{\circ}\text{C}$  ( $T_a=20^{\circ}\text{C}$ ).

# SMD Power Inductor CDRH5D16



## Saturation Current & Temperature Rise Graph

— L (20°C) — L (105°C) —  $\Delta T$

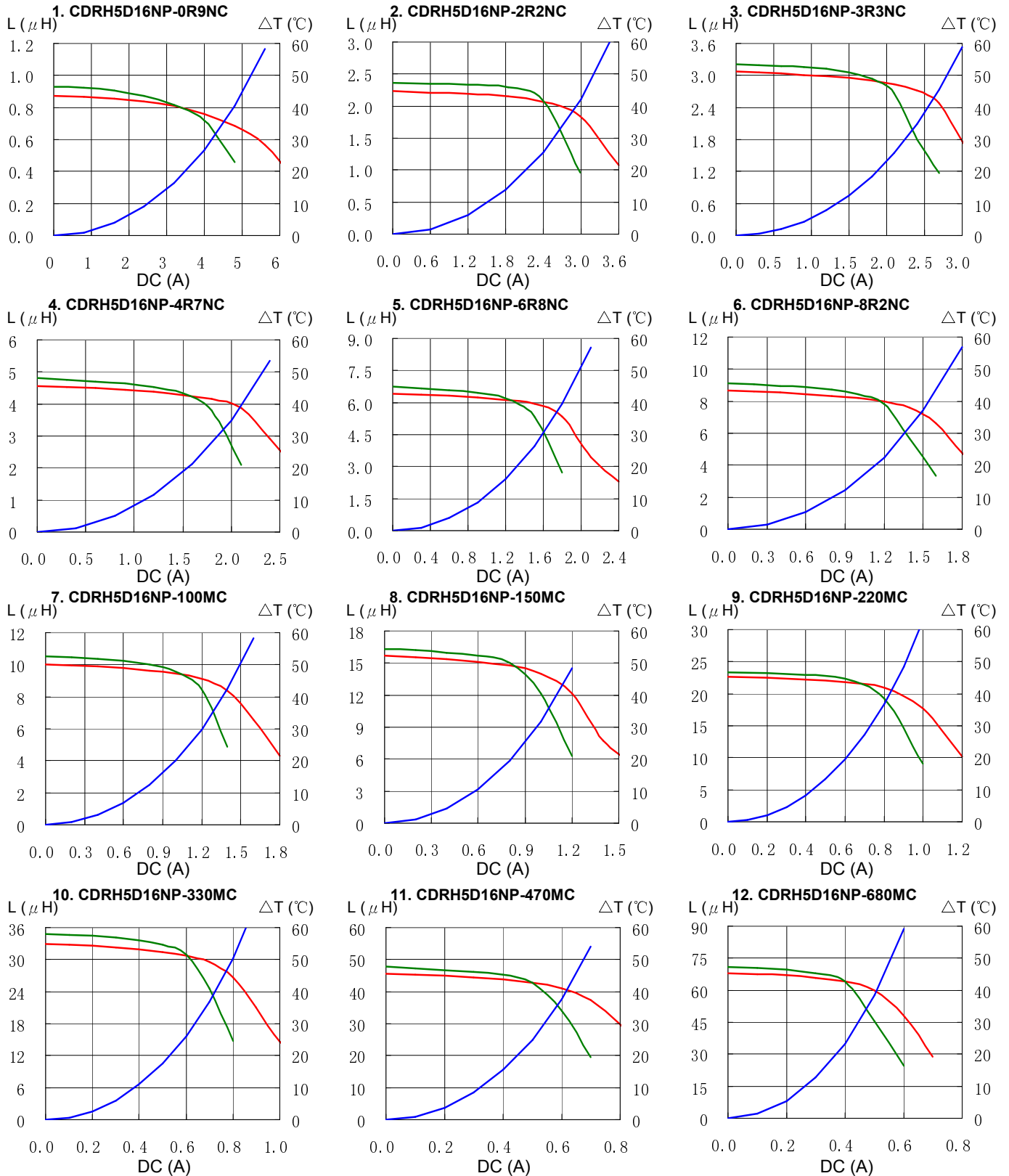

# SMD Power Inductor CDRH5D16



## Saturation Current & Temperature Rise Graph

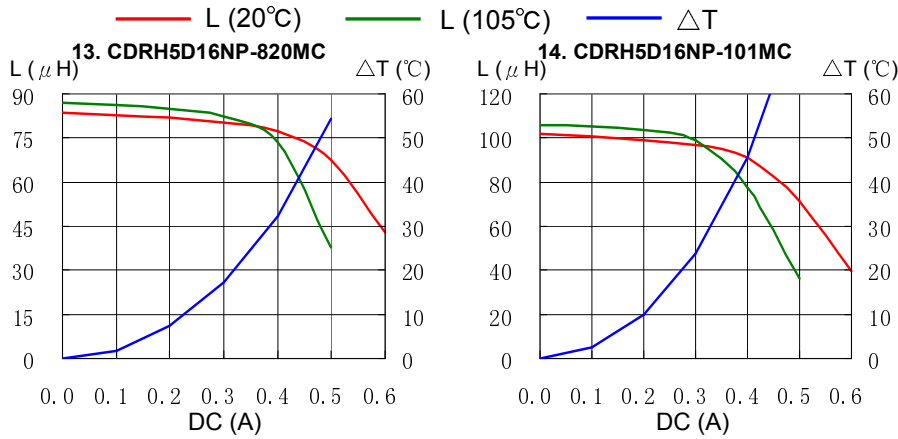

## Solder Reflow Condition

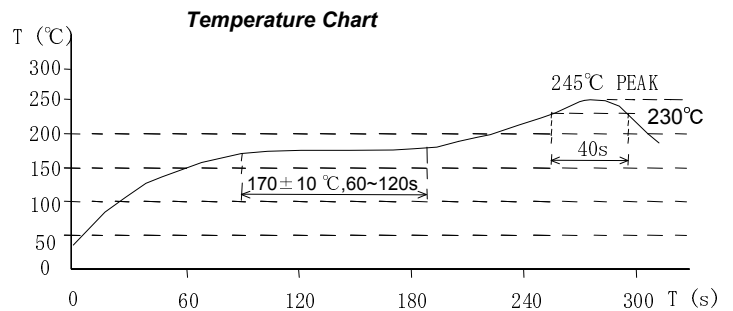
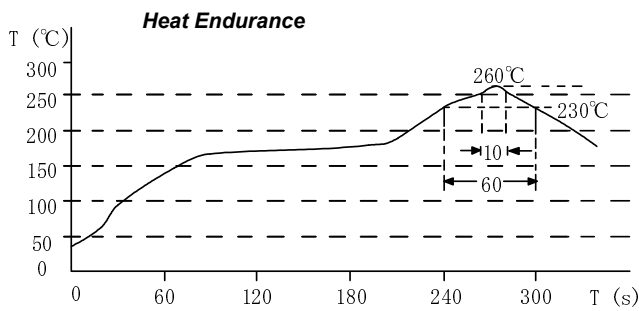

Please refer to the sales offices on our website - <http://www.sumida.com>

**Hong Kong**  
Tel.+852-2880-6781  
FAX.+852-2565-9600  
[sales@hk.sumida.com](mailto:sales@hk.sumida.com)

**Saitama(Japan)**  
Tel.+81-48-691-7300  
FAX.+81-48-691-7340  
[sales@jp.sumida.com](mailto:sales@jp.sumida.com)

**Chicago**  
Tel.+1-847-545-6700  
FAX. +1-847-545-6720  
[sales@us.sumida.com](mailto:sales@us.sumida.com)

**Shanghai**  
Tel.+86-21-5836-3299  
FAX.+86-21-5836-3266  
[shanghai.sales@cn.sumida.com](mailto:shanghai.sales@cn.sumida.com)

**Seoul**  
Tel.+82-2-6237-0777  
FAX.+82-2-6237-0778  
[sales@kr.sumida.com](mailto:sales@kr.sumida.com)

**Oberzell**  
Tel.+49-8591-937-0  
FAX. +49-8591-937-103  
[contact@eu.sumida.com](mailto:contact@eu.sumida.com)

**Shenzhen**  
Tel.+86-755-8291-0228  
FAX.+86-755-8291-0338  
[shenzhen.sales@cn.sumida.com](mailto:shenzhen.sales@cn.sumida.com)

**Singapore**  
Tel.+65-6296-3388  
FAX.+65-6841-4426  
[sales@sg.sumida.com](mailto:sales@sg.sumida.com)

**Neumarkt**  
Tel.+49-9181-4509-110  
FAX. +49-9181-4509-310  
[infocomp@eu.sumida.com](mailto:infocomp@eu.sumida.com)

**Taipei**  
Tel.+886-2-8751-2737  
FAX.+886-2-8751-2738  
[sales@tw.sumida.com](mailto:sales@tw.sumida.com)

**San Jose**  
Tel.+1-408-321-9660  
FAX.+1-408-321-9308  
[sales@us.sumida.com](mailto:sales@us.sumida.com)

## Looking for pricing, stock, or lifecycle information?

Click below to explore more details on WIN SOURCE:

- ⊖ [View CDRH5D16NP-8R2NC on WIN SOURCE](#)
- ⊖ [Sumida America Components Inc. Information](#)

## Optimize Your Supply Chain with WIN SOURCE Solutions

- ✓ Global Sourcing Solution
- ✓ Obsolete Management
- ✓ Cost Control Management
- ✓ Shortage Management
- ✓ Alternative Solution
- ✓ Excess Inventory Management