



**THE DATASHEET OF
S4006V**



Sxx06xSx & Sxx06x Series



Agency Approval

Agency	Agency File Number
	E71639*

* - L Package Only

Main Features

Symbol	Value	Unit
$I_{T(RMS)}$	6	A
V_{DRM}/V_{RRM}	400 to 1000	V
I_{GT}	0.2 to 15	mA

Additional Information



Datasheet



Resources



Samples

Description

This Sxx06x SCR series is ideal for uni-directional switch applications such as phase control, heating, motor speed controls, converters/rectifiers and capacitive discharge ignitions.

These SCRs have a low gate current trigger level of 0.2 to 15 mA at approximately 1.5V, with a sensitive version of this series having a gate trigger current less than 500µA. The sensitive gate SCR version is easily triggered by sense coils, proximity switches, and microprocessors.

Features & Benefits

- Halogen free and RoHS compliant
- Glass – passivated junctions
- Voltage capability up to 1000 V
- Surge capability up to 100 A at 60 Hz half cycle
- L-Package is UL recognized for 2500Vrms

Applications

Typical applications are capacitive discharge systems for strobe lights, nailers, staplers and gas engine ignition. Also, AC control & rectification for power tools, home/ brown goods and white goods appliances and 2-wheeler rectifier/battery regulators.

Internally constructed isolated packages are offered for ease of heat sinking with highest isolation voltage.

Schematic Symbol

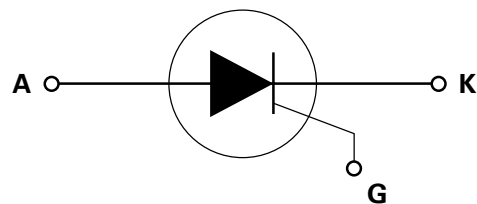

Absolute Maximum Ratings — Sensitive SCRs

Symbol	Parameter	Test Conditions		Value	Unit
$I_{T(RMS)}$	RMS on-state current	Sxx06LSy	$T_c = 80^\circ\text{C}$	6	A
		Sxx06NSy Sxx06RSy Sxx06DSy Sxx06VSy	$T_c = 95^\circ\text{C}$		
$I_{T(AV)}$	Average on-state current	Sxx06LSy	$T_c = 80^\circ\text{C}$	3.8	A
		Sxx06NSy Sxx06RSy Sxx06DSy Sxx06VSy	$T_c = 95^\circ\text{C}$		
I_{TSM}	Peak non-repetitive surge current	single half cycle; $f = 50\text{Hz}$; $T_J(\text{initial}) = 25^\circ\text{C}$		83	A
		single half cycle; $f = 60\text{Hz}$; $T_J(\text{initial}) = 25^\circ\text{C}$		100	
I^2t	I^2t Value for fusing	$t_p = 8.3\text{ ms}$		41	A^2s
di/dt	Critical rate of rise of on-state current	$f = 60\text{Hz}$; $T_J = 110^\circ\text{C}$		100	$\text{A}/\mu\text{s}$
I_{GTM}	Peak gate current	$T_J = 110^\circ\text{C}$		1	A
$P_{G(AV)}$	Average gate power dissipation	$T_J = 110^\circ\text{C}$		0.1	W
T_{stg}	Storage temperature range			-40 to 150	$^\circ\text{C}$
T_J	Operating junction temperature range			-40 to 110	$^\circ\text{C}$

Note: xx = voltage, y = sensitivity

Absolute Maximum Ratings — Standard SCRs

Symbol	Parameter	Test Conditions		Value	Unit
$I_{T(RMS)}$	RMS on-state current	Sxx06L	$T_c = 100^\circ\text{C}$	6	A
		Sxx06N Sxx06R Sxx06D Sxx06V	$T_c = 110^\circ\text{C}$		
$I_{T(AV)}$	Average on-state current	Sxx06L	$T_c = 100^\circ\text{C}$	3.8	A
		Sxx06N Sxx06R Sxx06D Sxx06V	$T_c = 110^\circ\text{C}$		
I_{TSM}	Peak non-repetitive surge current	single half cycle; $f = 50\text{Hz}$; $T_J(\text{initial}) = 25^\circ\text{C}$		83	A
		single half cycle; $f = 60\text{Hz}$; $T_J(\text{initial}) = 25^\circ\text{C}$		100	
I^2t	I^2t value for fusing	$t_p = 8.3\text{ ms}$		41	A^2s
di/dt	Critical rate-of-rise of on-state current	$f = 60\text{Hz}$; $T_J = 125^\circ\text{C}$		100	$\text{A}/\mu\text{s}$
I_{GTM}	Peak gate current	$T_J = 125^\circ\text{C}$		2	A
$P_{G(AV)}$	Average gate power dissipation	$T_J = 125^\circ\text{C}$		0.5	W
T_{stg}	Storage temperature range			-40 to 150	$^\circ\text{C}$
T_J	Operating junction temperature range			-40 to 125	$^\circ\text{C}$

Note: xx = voltage

Electrical Characteristics ($T_J = 25^\circ\text{C}$, unless otherwise specified) — Sensitive SCRs

Symbol	Test Conditions		Value		Unit
			Sxx06xS2	Sxx06xS3	
I_{GT}	$V_D = 6V$ $R_L = 100\ \Omega$	MAX.	200	500	μA
V_{GT}	$V_D = 6V$ $R_L = 100\ \Omega$	MAX.	0.8		V
dv/dt	$V_D = V_{DRM}$; $R_{GK} = 1\text{k}\Omega$; $T_J = 110^\circ\text{C}$	TYP.	8		V/ μs
V_{GD}	$V_D = V_{DRM}$ $R_L = 3.3\ \text{k}\Omega$ $T_J = 110^\circ\text{C}$	MIN.	0.2		V
V_{GRM}	$I_{GR} = 10\ \mu\text{A}$	MIN.	6		V
I_H	$I_T = 20\text{mA}$ (initial)	MAX.	6	8	mA
t_q	$I_T = 2\text{A}$; $t_p = 50\ \mu\text{s}$; $dv/dt = 5\text{V}/\mu\text{s}$; $di/dt = -30\text{A}/\mu\text{s}$	MAX.	50	45	μs
t_{gt}	$I_G = 2 \times I_{GT}$ $PW = 15\ \mu\text{s}$ $I_T = 12\text{A}$	TYP.	4	5	μs

Note: xx = voltage, x = package

Electrical Characteristics ($T_J = 25^\circ\text{C}$, unless otherwise specified) — Standard SCRs

Symbol	Test Conditions			Value	Unit
				Sxx06x	
I_{GT}	$V_D = 12V$ $R_L = 60\ \Omega$		MAX.	15	mA
V_{GT}	$V_D = 12V$ $R_L = 60\ \Omega$		MAX.	1.5	V
dv/dt	$V_D = V_{DRM}$; gate open; $T_J = 100^\circ\text{C}$	400V	MIN.	350	V/ μs
		600V		300	
		800V		250	
		1000V		100	
	$V_D = V_{DRM}$; gate open; $T_J = 125^\circ\text{C}$	400V		250	
		600V		225	
		800V		200	
V_{GD}	$V_D = V_{DRM}$ $R_L = 3.3\ \text{k}\Omega$ $T_J = 125^\circ\text{C}$		MIN.	0.2	V
I_H	$I_T = 200\text{mA}$ (initial)		MAX.	30	mA
t_q	$I_T = 2\text{A}$; $t_p = 50\ \mu\text{s}$; $dv/dt = 5\text{V}/\mu\text{s}$; $di/dt = -30\text{A}/\mu\text{s}$		MAX.	35	μs
t_{gt}	$I_G = 2 \times I_{GT}$ $PW = 15\ \mu\text{s}$ $I_T = 12\text{A}$		TYP.	2	μs

Note: xx = voltage, x = package

Static Characteristics

Symbol	Test Conditions		Value	Unit	
V_{TM}	$I_T = 12A; t_p = 380 \mu s$		MAX.	1.6 V	
I_{DRM} / I_{RRM}	Sxx06xyy	$T_J = 25^\circ C$	400 – 600V	MAX.	5
		$T_J = 110^\circ C$	400 – 600V		250
	Sxx06x	$T_J = 25^\circ C$	400 – 800V		10
			1000V		20
		$T_J = 100^\circ C$	400 – 800V		200
			1000V		3000
	$T_J = 125^\circ C$	400 – 800V	500		

Note: xx = voltage, x = package, yy = sensitivity

Thermal Resistances

Symbol	Parameter	Value	Unit	
$R_{\theta(J-C)}$	Junction to case (AC)	Sxx06RSy / Sxx06NSy	2.6	$^\circ C/W$
		Sxx06LSy	4.3	
		Sxx06VSY	2.4	
		Sxx06DSy	1.8	
		Sxx06R / Sxx06N	2.5	
		Sxx06L	4.0	
		Sxx06V	2.3	
$R_{\theta(J-A)}$	Junction to ambient	Sxx06RSy	40	$^\circ C/W$
		Sxx06LSy	65	
		Sxx06VSY	85	
		Sxx06R	40	
		Sxx06L	50	
		Sxx06V	70	

Note: xx = voltage, y = sensitivity

Figure 1: Normalized DC Gate Trigger Current vs. Junction Temperature (Sensitive SCR)



Figure 2: Normalized DC Gate Trigger Current vs. Junction Temperature (Standard SCR)



Figure 3: Normalized DC Gate Trigger Voltage vs. Junction Temperature



Figure 4: Normalized DC Holding Current vs. Junction Temperature



Figure 5: On-State Current vs. On-State Voltage (Typical)



Figure 6: Power Dissipation (Typical) vs. RMS On-State Current



Figure 7: Maximum Allowable Case Temperature vs. RMS On-State Current



Figure 8: Maximum Allowable Case Temperature vs. Average On-State Current



Figure 9: Maximum Allowable Ambient Temperature vs. RMS On-State Current

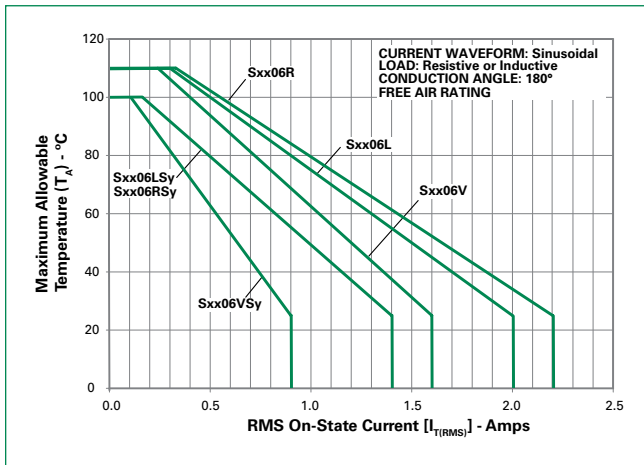
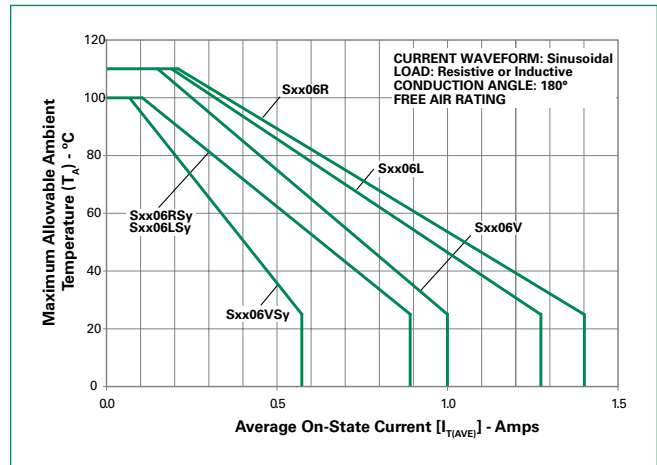

Figure 10: Maximum Allowable Ambient Temperature vs. Average On-State Current



Note: xx = voltage, y = sensitivity

Figure 11: Peak Capacitor Discharge Current

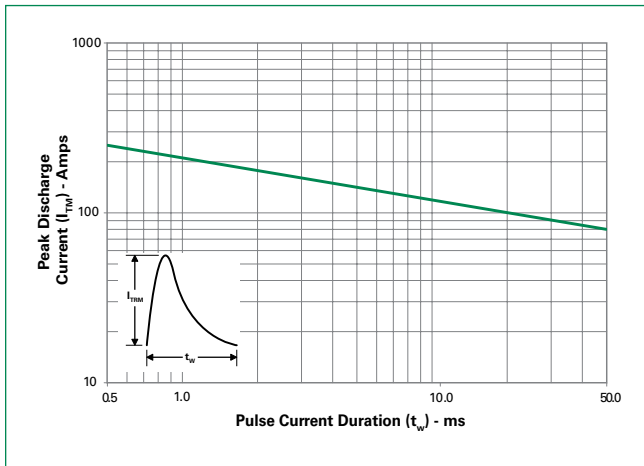

Figure 12: Peak Capacitor Discharge Current Derating

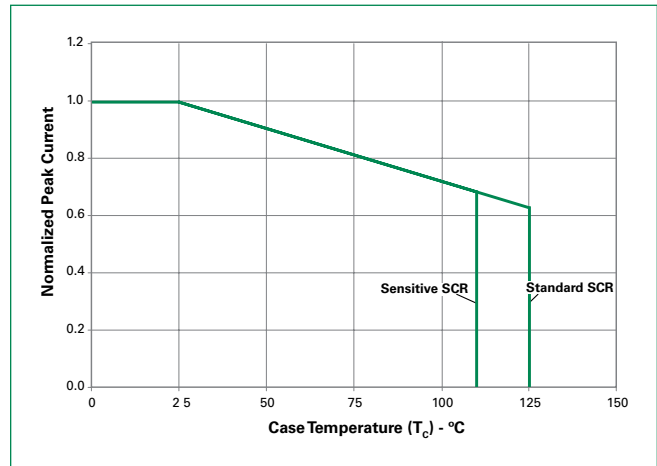

Figure 13-1: Typical DC Gate Trigger Current with R_{GK} vs. Junction Temperature for S6008DS2



Figure 13-2: Typical DC Gate Trigger Current with R_{GK} vs. Junction Temperature for SS6008DS3



Figure 14-1: Typical DC Holding Current with R_{GK} vs. Junction Temperature for S6008DS2



Figure 14-2: Typical DC Holding Current with R_{GK} vs. Junction Temperature for SS6008DS3



Figure 15-1: Typical Static dv/dt with R_{GK} vs. Junction Temperature for S6008DS2



Figure 15-2: Typical Static dv/dt with R_{GK} vs. Junction Temperature for SS6008DS3



Figure 16-1: Typical Static dv/dt with R_{GK} vs. Junction Temperature for S6008DS2



Figure 16-2 Typical Static dv/dt with R_{GK} vs. Junction Temperature for SS6008DS3



Figure 17: Surge Peak On-State Current vs. Number of Cycles



Soldering Parameters

Reflow Condition		Pb – Free assembly
Pre Heat	- Temperature Min ($T_{s(min)}$)	150°C
	- Temperature Max ($T_{s(max)}$)	200°C
	- Time (min to max) (t_s)	60 – 180 secs
Average ramp up rate (Liquidus Temp) (T_L) to peak		5°C/second max
$T_{s(max)}$ to T_L - Ramp-up Rate		5°C/second max
Reflow	- Temperature (T_L) (Liquidus)	217°C
	- Temperature (t_L)	60 – 150 seconds
Peak Temperature (T_p)		260 ^{+0/-5} °C
Time within 5°C of actual peak Temperature (t_p)		20 – 40 seconds
Ramp-down Rate		5°C/second max
Time 25°C to peak Temperature (T_p)		8 minutes Max.
Do not exceed		280°C



Physical Specifications

Terminal Finish	100% Matte Tin-plated
Body Material	UL recognized epoxy meeting flammability rating 94V-0
Lead Material	Copper Alloy

Design Considerations

Careful selection of the correct component for the application's operating parameters and environment will go a long way toward extending the operating life of the Thyristor. Good design practice should limit the maximum continuous current through the main terminals to 75% of the component rating. Other ways to ensure long life for a power discrete semiconductor are proper heat sinking and selection of voltage ratings for worst case conditions. Overheating, overvoltage (including dv/dt), and surge currents are the main killers of semiconductors. Correct mounting, soldering, and forming of the leads also help protect against component damage.

Environmental Specifications

Test	Specifications and Conditions
AC Blocking	MIL-STD-750, M-1040, Cond A Applied Peak AC voltage @ 125°C for 1008 hours
Temperature Cycling	MIL-STD-750, M-1051, 100 cycles; -40°C to +150°C; 15-min dwell-time
Temperature/Humidity	EIA / JEDEC, JESD22-A101 1008 hours; 320V - DC: 85°C; 85% rel humidity
High Temp Storage	MIL-STD-750, M-1031, 1008 hours; 150°C
Low-Temp Storage	1008 hours; -40°C
Resistance to Solder Heat	MIL-STD-750 Method 2031
Solderability	ANSI/J-STD-002, category 3, Test A
Lead Bend	MIL-STD-750, M-2036 Cond E

Product Selector

Part Number	Voltage				Gate Sensitivity	Type	Package
	400V	600V	800V	1000V			
Sxx06RS2	X	X	-	-	0.2mA	Sensitive SCR	TO-220R
Sxx06LS2	X	X	-	-	0.2mA	Sensitive SCR	TO-220L
Sxx06VS2	X	X	-	-	0.2mA	Sensitive SCR	TO-251
Sxx06DS2	X	X	-	-	0.2mA	Sensitive SCR	TO-252
Sxx06RS3	X	X	-	-	0.5mA	Sensitive SCR	TO-220R
Sxx06LS3	X	X	-	-	0.5mA	Sensitive SCR	TO-220L
Sxx06VS3	X	X	-	-	0.5mA	Sensitive SCR	TO-251
Sxx06DS3	X	X	-	-	0.5mA	Sensitive SCR	TO-252
Sxx06R	X	X	X	X	15mA	Standard SCR	TO-220R
Sxx06L	X	X	X	X	15mA	Standard SCR	TO-220L
Sxx06V	X	X	X	X	15mA	Standard SCR	TO-251
Sxx06D	X	X	X	X	15mA	Standard SCR	TO-252

Note: xx = voltage

Dimensions – TO-251AA (V/I-Package) – V/I-PAK Through Hole



Dimension	Inches			Millimeters		
	Min	Typ	Max	Min	Typ	Max
A	0.037	0.040	0.043	0.94	1.01	1.09
B	0.235	0.242	0.245	5.97	6.15	6.22
C	0.350	0.361	0.375	8.89	9.18	9.53
D	0.205	0.208	0.213	5.21	5.29	5.41
E	0.255	0.262	0.265	6.48	6.66	6.73
F	0.027	0.031	0.033	0.69	0.80	0.84
G	0.087	0.090	0.093	2.21	2.28	2.36
H	0.085	0.092	0.095	2.16	2.34	2.41
I	0.176	0.180	0.184	4.47	4.57	4.67
J	0.018	0.020	0.023	0.46	0.51	0.58
K	0.035	0.037	0.039	0.90	0.95	1.00
L	0.018	0.020	0.023	0.46	0.52	0.58
P	0.042	0.047	0.052	1.06	1.20	1.32
Q	0.034	0.039	0.044	0.86	1.00	1.11
R	0.034	0.039	0.044	0.86	1.00	1.11
S	0.074	0.079	0.084	1.86	2.00	2.11

Dimensions – TO-252AA (D-Package) – D-PAK Surface Mount



Dimension	Inches			Millimeters		
	Min	Typ	Max	Min	Typ	Max
A	0.037	0.040	0.043	0.94	1.01	1.09
B	0.235	0.243	0.245	5.97	6.16	6.22
C	0.106	0.108	0.113	2.69	2.74	2.87
D	0.205	0.208	0.213	5.21	5.29	5.41
E	0.255	0.262	0.265	6.48	6.65	6.73
F	0.027	0.031	0.033	0.69	0.80	0.84
G	0.087	0.090	0.093	2.21	2.28	2.36
H	0.085	0.092	0.095	2.16	2.33	2.41
I	0.176	0.179	0.184	4.47	4.55	4.67
J	0.018	0.020	0.023	0.46	0.51	0.58
K	0.035	0.037	0.039	0.90	0.95	1.00
L	0.018	0.020	0.023	0.46	0.51	0.58
M	0.000	0.000	0.004	0.00	0.00	0.10
N	0.021	0.026	0.027	0.53	0.67	0.69
O	0°	0°	5°	0°	0°	5°
P	0.042	0.047	0.052	1.06	1.20	1.32
Q	0.034	0.039	0.044	0.86	1.00	1.11

Dimensions — TO-220AB (R-Package) — Non-Isolated Mounting Tab Common with Center Lead

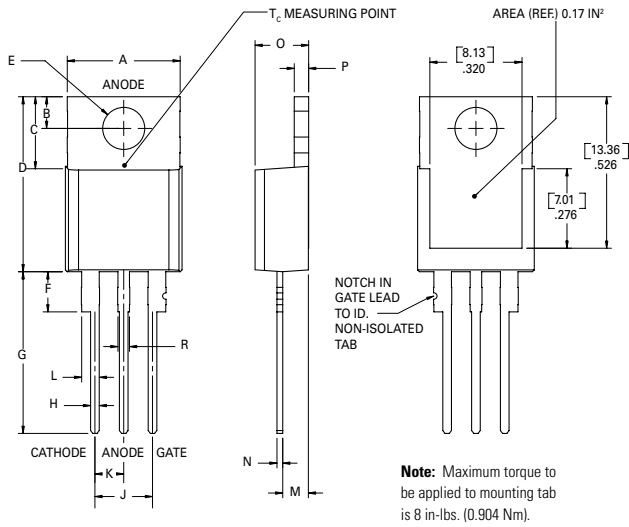

Dimension	Inches		Millimeters	
	Min	Max	Min	Max
A	0.380	0.420	9.65	10.67
B	0.105	0.115	2.67	2.92
C	0.230	0.250	5.84	6.35
D	0.590	0.620	14.99	15.75
E	0.142	0.147	3.61	3.73
F	0.110	0.130	2.79	3.30
G	0.540	0.575	13.72	14.61
H	0.025	0.035	0.64	0.89
J	0.195	0.205	4.95	5.21
K	0.095	0.105	2.41	2.67
L	0.060	0.075	1.52	1.91
M	0.085	0.095	2.16	2.41
N	0.018	0.024	0.46	0.61
O	0.178	0.188	4.52	4.78
P	0.045	0.060	1.14	1.52
R	0.038	0.048	0.97	1.22

Dimensions — TO-220AB (L-Package) — Isolated Mounting Tab



Dimension	Inches		Millimeters	
	Min	Max	Min	Max
A	0.380	0.420	9.65	10.67
B	0.105	0.115	2.67	2.92
C	0.230	0.250	5.84	6.35
D	0.590	0.620	14.99	15.75
E	0.142	0.147	3.61	3.73
F	0.110	0.130	2.79	3.30
G	0.540	0.575	13.72	14.61
H	0.025	0.035	0.64	0.89
J	0.195	0.205	4.95	5.21
K	0.095	0.105	2.41	2.67
L	0.060	0.075	1.52	1.91
M	0.085	0.095	2.16	2.41
N	0.018	0.024	0.46	0.61
O	0.178	0.188	4.52	4.78
P	0.045	0.060	1.14	1.52
R	0.038	0.048	0.97	1.22

Dimensions — TO-263 (N Package) — D²Pak Surface Mount



Dimension	Inches		Millimeters	
	Min	Max	Min	Max
A	0.360	0.370	9.14	9.40
B	0.380	0.420	9.65	10.67
C	0.178	0.188	4.52	4.78
D	0.025	0.035	0.64	0.89
E	0.045	0.060	1.14	1.52
F	0.060	0.075	1.52	1.91
G	0.095	0.105	2.41	2.67
H	0.092	0.102	2.34	2.59
J	0.018	0.024	0.46	0.61
K	0.090	0.110	2.29	2.79
S	0.590	0.625	14.99	15.88
V	0.035	0.045	0.89	1.14
U	0.002	0.010	0.05	0.25
W	0.040	0.070	1.02	1.78

Packing Options

Part Number	Marking	Weight	Packing Mode	Base Quantity
Sxx06L/RyyTP	Sxx06L/Ryy	2.2 g	Tube	1000 (50 per tube)
Sxx06DyyTP	Sxx06Dyy	0.3 g	Tube	750 (75 per tube)
Sxx06DyyRP	Sxx06Dyy	0.3 g	Embossed Carrier	2500
Sxx06VyyTP	Sxx06Vyy	0.4 g	Tube	750 (75 per tube)
Sxx06L/RTP	Sxx06L/R	2.2 g	Tube	1000 (50 per tube)
Sxx06DTP	Sxx06D	0.3 g	Tube	750 (75 per tube)
Sxx06DRP	Sxx06D	0.3 g	Embossed Carrier	2500
Sxx06VTP	Sxx06V	0.4 g	Tube	750 (75 per tube)
Sxx06NyyRP	Sxx6Nyy	1.6g	Embossed Carrier	500
Sxx06NyyTP	Sxx6Nyy	1.6g	Tube	1000 (50 per tube)
Sxx06NRP	Sxx6N	1.6g	Embossed Carrier	500
Sxx06NTP	Sxx6N	1.6g	Tube	1000 (50 per tube)

Note: xx = Voltage/10; yy = Sensitivity

TO-252 Embossed Carrier Reel Pack (RP) Specs

Meets all EIA-481-2 Standards

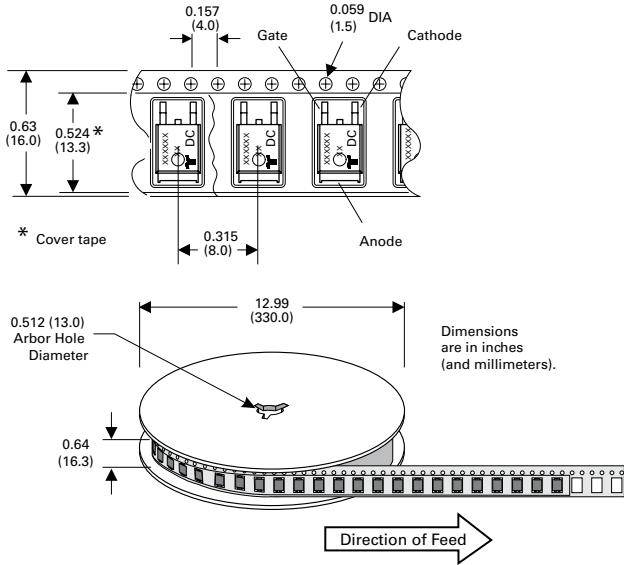

Part Marking System

TO-251AA- (V Package)
TO-252AA- (D Package)

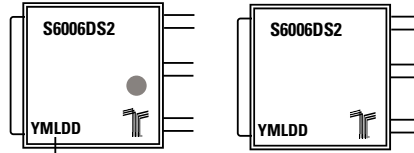

Date Code Marking
Y: Year Code
M: Month Code
L: Location Code
DD: Calendar Code

TO-263 AA - (N Package)
TO-220 AB - (L and R Package)



Date Code Marking
Y: Year Code
M: Month Code
XXX: Lot Trace Code

Part Numbering System



Looking for pricing, stock, or lifecycle information?

Click below to explore more details on WIN SOURCE:

 [View S4006V on WIN SOURCE](#)

 [Littelfuse Inc. Information](#)

Optimize Your Supply Chain with WIN SOURCE Solutions

-  Global Sourcing Solution
-  Obsolete Management
-  Cost Control Management
-  Shortage Management
-  Alternative Solution
-  Excess Inventory Management