



# THE DATASHEET OF TDA7511





## AM/FM TUNER FOR CAR RADIO AND HIFI APPLICATIONS

### FM-PART

- RF AGC GENERATION BY RF AND IF DETECTION FOR PIN DIODES AND MOSFET (PRESTAGE)
- 1<sup>ST</sup> MIXER FOR 1<sup>ST</sup> FM IF 10.7MHz WITH PROGRAMMABLE IF TANK ADJUST FOR FM AND AM UPCONVERSION
- 2 PROGRAMMABLE IF-GAIN STAGES
- 2<sup>ND</sup> MIXER FOR 2<sup>ND</sup> IF 450KHz
- INTERNAL IF BANDPASS FILTER WITH THREE BANDWIDTHS CONTROLLED BY ISS (INCLUDING WEATHER BAND)
- FULLY INTEGRATED FM-DEMODULATOR

### AM-PART

- WIDE AND NARROW AGC GENERATION
- PREAMPLIFIER AND MIXER FOR 1<sup>ST</sup> IF 10.7MHz, AM UPCONVERSION
- 2<sup>ND</sup> MIXER FOR 2<sup>ND</sup> IF 450 KHz
- INTEGRATED AM-DEMODULATOR
- OUTPUT FOR AM-STEREO-DECODER

### ADDITIONAL FEATURES

- HIGH PERFORMANCE FAST PLL FOR RDS-SYSTEM
- IF COUNTER FOR FM AND AM UPCONVERSION WITH SEARCH STOP SIGNAL
- QUALITY DETECTOR FOR LEVEL, DEVIATION, ADJACENT CHANNEL AND

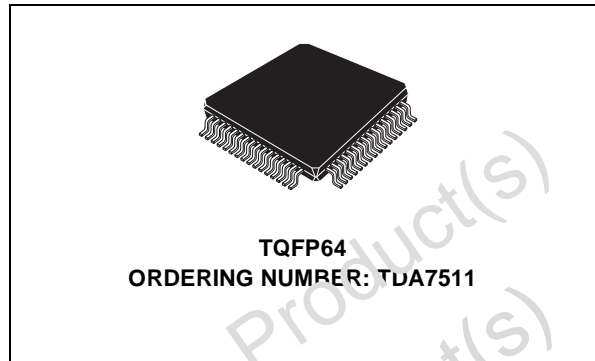

### MULTIPATH

- QUALITY DETECTION INFORMATIONS AS ANALOG SIGNALS EXTERNAL AVAILABLE
- ISS (INTELLIGENT SELECTIVITY SYSTEM) FOR CANCELLATION OF ADJACENT CHANNEL AND NOISE INFLUENCES
- ADJACENT CHANNEL MUTE
- FULLY ELECTRONIC ALIGNMENT
- ALL FUNCTIONS I<sup>2</sup>C-BUS CONTROLLED
- ISS FILTER STATUS INFORMATION I<sup>2</sup>C-BUS READABLE

### DESCRIPTION

The TDA 7511 is a high performance tuner circuit for AM/FM car radio. It contains mixers, IF amplifiers, demodulators for AM and FM, quality detection, ISS filter and PLL synthesizer with IF counter on a single chip.

Use of BICMOS technology allows the implementation of several tuning functions and a minimum of external components.

BLOCK DIAGRAM

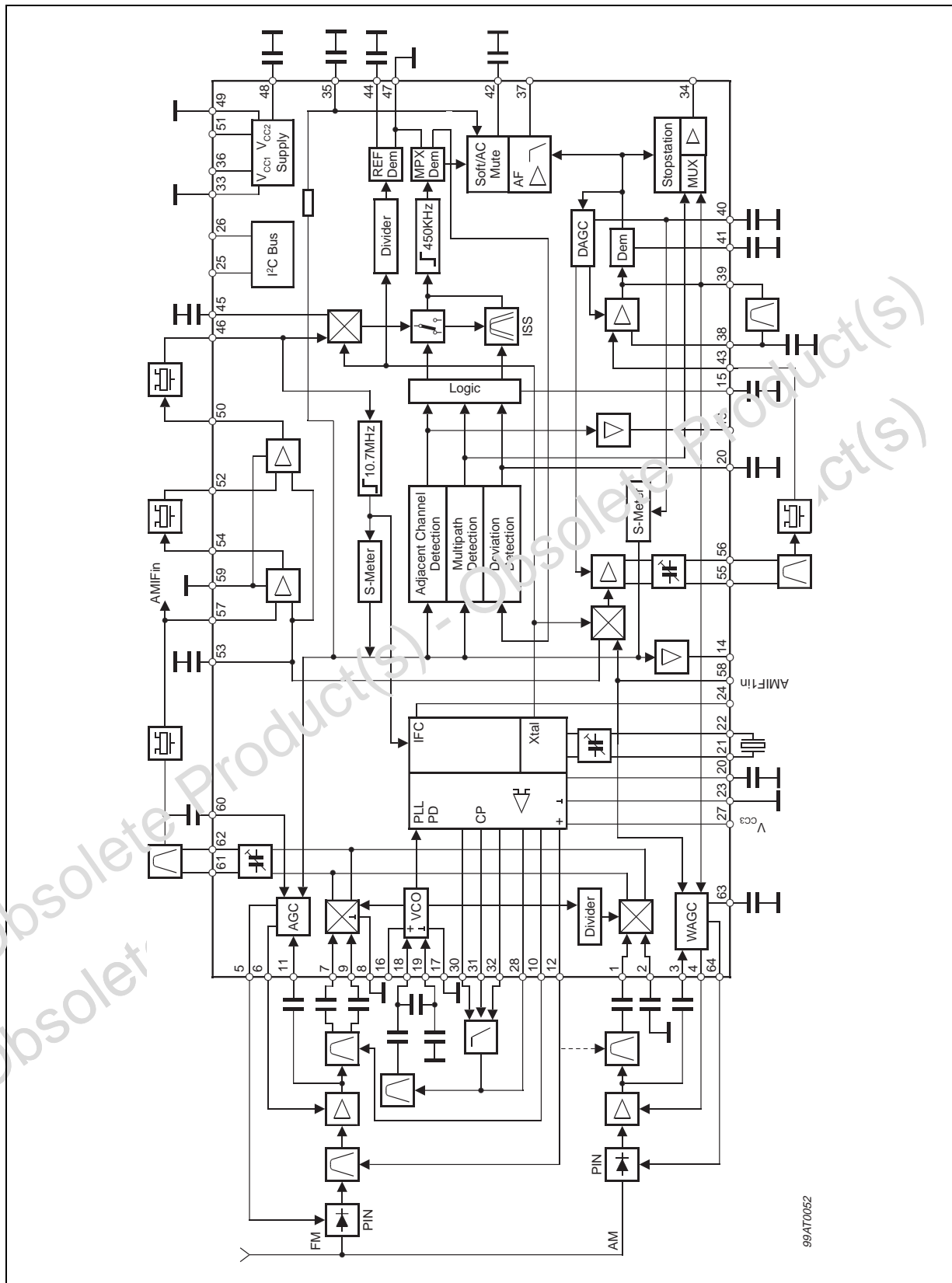

99AT0052



## PIN CONNECTION (Top view)

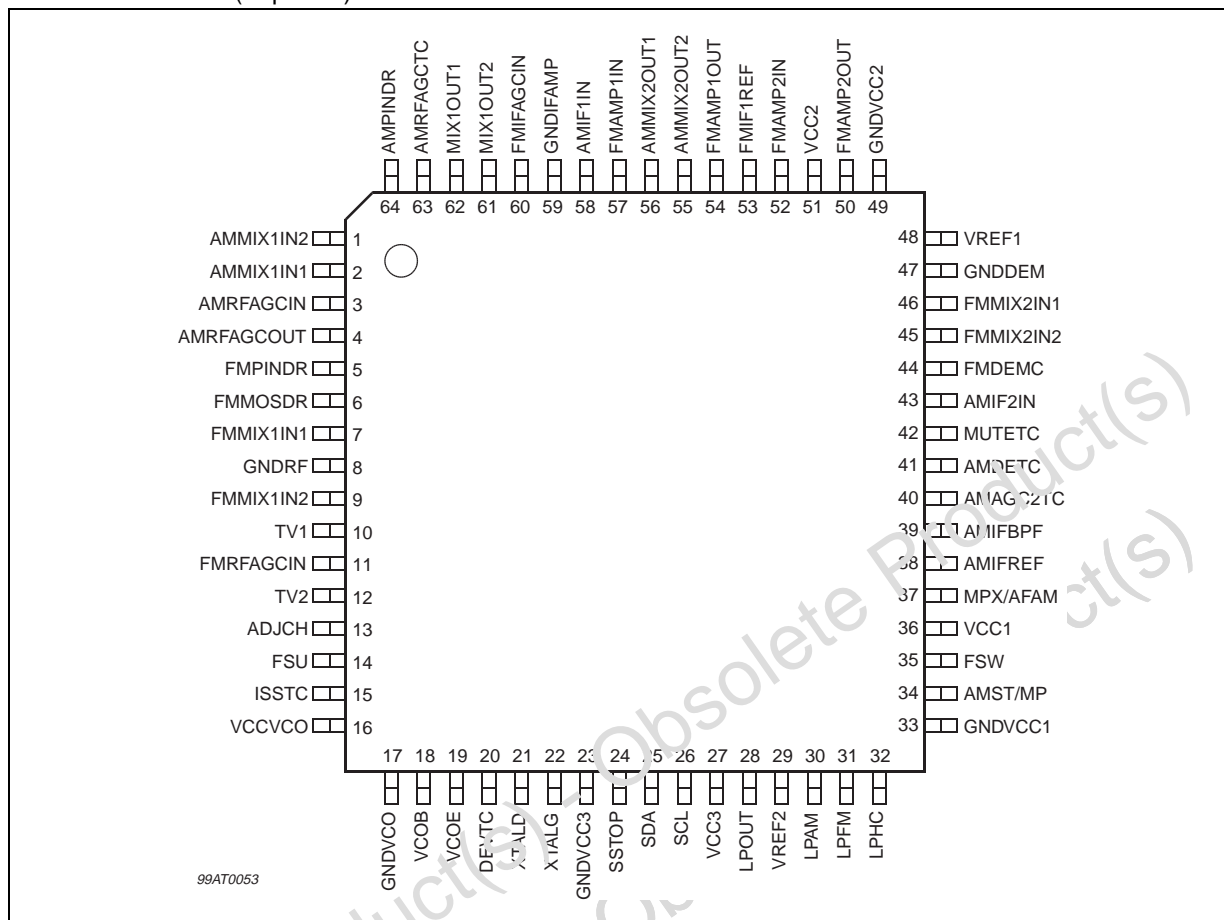

## PIN DESCRIPTION (continued)

N°	Pin	Function
1	AMMIX1IN2	AM Input2 Mixer1
2	AMMIX1IN1	AM Input1 Mixer1 Reference
3	AMRFAGCIN	Input AM RF AGC
4	AMRFAGCOUT	Output AM RF AGC
5	FMPINDR	FM PIN Diode Driver Output
6	FMMOSDR	FM MOS Driver Output
7	FMMIX1IN1	FM Input1 Mixer1
8	GNDRF	RF Ground
9	FMMIX1IN2	FM Input2 Mixer1
10	TV1	Tuning Voltage 1
11	FMRFAGCIN	FM RF AGC Input
12	TV2	Tuning Voltage 2
13	ADJCH	Ident. Adjacent Channel Output
14	FSU	Unweighted Fieldstrength Output

## PIN DESCRIPTION (continued)

N°	Pin	Function
15	ISSTC	Time Constant for ISS Filter Switch
16	VCCVCO	VCO Supply
17	GNDVCO	VCO Ground
18	VCOB	VCO Input Base
19	VCOE	VCO Output Emitter
20	DEVTC	Deviation Detector Time Constant
21	XTALD	Xtal Oscillator to MOS Drain
22	XTALG	Xtal Oscillator to MOS Gate
23	GNDVCC3	VCC3 Ground
24	SSTOP	Search Stop Output
25	SDA	I <sup>2</sup> C-Bus Data
26	SCL	I <sup>2</sup> C-Bus Clock
27	VCC3	Supply Tuning Voltage
28	LPOUT	Op Amp Output to PLL Loop Filters
29	VREF2	Voltage Reference for PLL Op Amp
30	LPAM	Op Amp Input to PLL Loop Filters AM
31	LPFM	Op Amp Input to PLL Loop Filters FM
32	LPHC	High Current PLL Loop Filter Input
33	GNDVCC1	Digital Ground
34	AMST/MP	AM Stereo Out / Ident. Multipath Output
35	FSW	Weighted Fieldstrength Output
36	VCC1	Digital Supply
37	MPX/AFAM	MPX Output / AM AF Output
38	AMIFREF	Reference Voltage AM IF Amp
39	AMIFBPF	AM IF Filter
40	AMAGC2TC	AM AGC2 Time Constant
41	AMDETC	AM Detector Capacitor
42	MUTETC	Softmute Time Constant
43	AMIF2IN	Input AM IF2
44	FMDEMC	FM Demodulator Reference
45	FMMIX2IN2	FM IF1 MIX2 Input1
46	FMMIX2IN1	FM IF1 MIX2 Input2
47	GNDDEM	Ground FM Demodulator
48	VREF1	Reference 5V
49	GNDVCC2	Analog Ground
50	FMAMP2OUT	FM IF1 Amplifier2 Output

## PIN DESCRIPTION (continued)

N°	Pin	Function
51	VCC2	Analog Supply
52	FMAMP2IN	FM IF1 Amplifier2 Input
53	FMIF1REF	FM IF1 Amplifier Reference
54	FMAMP1OUT	FM IF1 Amplifier1 Output
55	AMMIX2OUT2	AM Tank 450kHz
56	AMMIX2OUT1	AM Tank 450kHz
57	FMAMP1IN	FM IF1 Amplifier1 Input
58	AMIF1IN	AM IF1 Input
59	GNDIF1AMP	FM IF1 Amplifier Ground
60	FMIF1AGCIN	FM IF1 AGC Input
61	MIX1OUT2	MIX Tank 10.7MHz
62	MIX1OUT1	MIX Tank 10.7MHz
63	AMRFAGCTC	AM RF AGC Time Constant
64	AMPINDR	AM PIN Diode Driver Output

## ABSOLUTE MAXIMUM RATINGS

Symbol	Parameter	Value	Unit
V <sub>S</sub>	Supply Voltage	10.5	V
T <sub>amb</sub>	Ambient Temperature	-40 to 85	°C
T <sub>stg</sub>	Storage Temperature	-55 to +150	°C

## THERMAL DATA

Symbol	Parameter	Value	Unit
R <sub>Th(j-amb)</sub>	Thermal resistance	68	°C/W

## ELECTRICAL CHARACTERISTICS

T<sub>amb</sub> = +25°C, V<sub>CC1</sub> = V<sub>CC2</sub> = V<sub>CC3</sub> = V<sub>CCVCO</sub> = V<sub>CCMIX1</sub> = 8.5V, f<sub>RF</sub> = 98MHz, dev. = 40kHz, f<sub>MOD</sub> = 1kHz, f<sub>IF1</sub> = 10.7MHz, f<sub>IF2</sub> = 450KHz, f<sub>Xtal</sub> = 10.25MHz, in test or application circuit, unless otherwise specified.

Symbol	Parameter	Test Condition	Min.	Typ.	Max.	Unit
<b>Supply</b>						
V <sub>CC1</sub>	Digital supply voltage		7.5	8.5	10	V
V <sub>CC2</sub>	Analog supply voltage		7.5	8.5	10	V
V <sub>CC3</sub>	Analog tuning voltage		7.5	8.5	10	V
V <sub>CCVCO</sub>	VCO supply voltage		7.5	8.5	10	V

**ELECTRICAL CHARACTERISTICS** (continued)

$T_{amb} = +25^{\circ}\text{C}$ ,  $V_{CC1} = V_{CC2} = V_{CC3} = V_{CCVCO} = V_{CCMIX1} = 8.5\text{V}$ ,  $f_{RF} = 98\text{MHz}$ , dev. = 40kHz,  
 $f_{MOD} = 1\text{kHz}$ ,  $f_{IF1} = 10.7\text{MHz}$ ,  $f_{IF2} = 450\text{kHz}$ ,  $f_{Xtal} = 10.25\text{MHz}$ , in test or application circuit, unless otherwise specified.

Symbol	Parameter	Test Condition	Min.	Typ.	Max.	Unit
$V_{CCMIX1}$	MIX1 supply voltage		7.5	8.5	10	V
$V_{CCMIX2}$	MIX2 supply voltage		7.5	8.5	10	V
$I_{CC1}$	Supply current	FM ON		7.5		mA
$I_{CC1}$	Supply current	AM ON		10		mA
$I_{CC2}$	Supply current	FM ON		50		mA
$I_{CC2}$	Supply current	AM ON		60		mA
$I_{CC3}$	Supply current			2		mA
$I_{CCVCO}$	Supply current			2.5		mA
$I_{CCMIX1}$	Supply current	FM ON		6		mA
$I_{CCMIX1}$	Supply current	AM ON		5		mA
$I_{CCMIX2}$	Supply current	AM ON		5		mA
<b>Reference Voltages</b>						
$V_{REF1}$	Internal reference voltage	$I_{REF1} = 0\text{mA}$		5		V
$V_{REF2}$	Internal reference voltage	$I_{REF2} = 0\text{nA}$		2.5		V
<b>Wide Band RF AGC</b>						
$V_{11}$	Threshold AGC start	$V_6 = V_{CC2}/2$		80		$\text{dB}\mu\text{V}$
$R_{IN}$	Input resistance			500		$\Omega$
$C_{IN}$	Input capacitance			2.5		pF
<b>Narrow Band RF &amp; Kevir g A C C</b>						
$V_{60}$	Lower threshold	FMAGC, $V_{11} = 0\text{mV}_{RMS}$		82		$\text{dB}\mu\text{V}$
$V_{60}$	Upper threshold	FMAGC, $V_{11} = 0\text{mV}_{RMS}$		92		$\text{dB}\mu\text{V}$
$R_{IN}$	Input resistance			10		$\text{k}\Omega$
$C_{IN}$	Input capacitance			2.5		pF
<b>AGC MOSFET Driver Output</b>						
$V_6$	Max. AGC output voltage	$V_{11} = 0\text{mV}_{RMS}$	$V_{CC2} - 0.5\text{V}$			V
$V_6$	Min. AGC output voltage	$V_{11} = 50\text{mV}_{RMS}$			0.5	V
$I_6$	Min. AGC charge current	$V_{11} = 0\text{mV}_{RMS}, V_6 = V_{CC2}/2$		-12.5		$\mu\text{A}$
$I_6$	Max. AGC discharge current	$V_{11} = 50\text{mV}_{RMS}, V_6 = V_{CC2}/2$		1.25		mA
<b>AGC PIN Diode Driver Output</b>						
$I_5$	AGC OUT, current min.	$V_{11} = 0\text{mV}_{RMS}, V_5 = 2\text{V}$		50		$\mu\text{A}$
$I_5$	AGC OUT, current max.	$V_{11} = 50\text{mV}_{RMS}, V_5 = 2\text{V}$		-6		mA
<b>Mixer1 (10.7MHz)</b>						
$R_{IN}$	Input impedance	Balanced, $f = 98\text{MHz}$		9		$\Omega$

**ELECTRICAL CHARACTERISTICS** (continued)

$T_{amb} = +25^{\circ}\text{C}$ ,  $V_{CC1} = V_{CC2} = V_{CC3} = V_{CCVCO} = V_{CCMIX1} = 8.5\text{V}$ ,  $f_{RF} = 98\text{MHz}$ ,  $dev. = 40\text{kHz}$ ,  
 $f_{MOD} = 1\text{kHz}$ ,  $f_{IF1} = 10.7\text{MHz}$ ,  $f_{IF2} = 450\text{kHz}$ ,  $f_{Xtal} = 10.25\text{MHz}$ , in test or application circuit, unless otherwise specified.

Symbol	Parameter	Test Condition	Min.	Typ.	Max.	Unit
IP3	3rd order intercept point			122		$\text{dB}\mu\text{V}$
F	Noise figure			6		dB
$A_C$	Conversion gain			120		mS
<b>IF1 Amplifier1 &amp; 2 (10.7MHz)</b>						
$A_{min}$	Min. gain	IFG		9		dB
$A_{max}$	Max. gain	IFG		15		dB
$R_{IN}$	Input resistance			330		$\Omega$
$R_{OUT}$	Output resistance			300		$\Omega$
$P_{1dB}$	1dB compression point	Output referred		120		$\text{dB}\mu\text{V}$
IP3	3rd order Intercept Point	Output referred		132		$\text{dB}\mu\text{V}$
<b>Mixer2 (450kHz)</b>						
$R_{IN}$	Input impedance			330		$\Omega$
$V_{46}$	Max. input voltage			900		$\text{mV}_{RMS}$
$V_{48}$	Limiting sensitivity	S/N = 20dB		25		$\mu\text{V}$
A	Mixer gain			18		dB
<b>Limiter 1 (450kHz)</b>						
$G_{Limiter}$	Gain			80		dB
<b>Demodulator, Audio Output</b>						
THD		Dev.= 75kHz, $V_{46} = 10\text{mV}_{RMS}$			0.1	%
$V_{MPX}$	MPX output signal	Dev.= 75kHz		500		$\text{mV}_{RMS}$
$R_{OUT}$	Output resistance			350		$\Omega$
$ \Delta V _{min}$	DC offset fine adjust	DEM, MENA=1		6		mV
$ \Delta V _{max}$	DC offset fine adjust	DEM, MENA=1		186		mV
S/N		Dev.= 40kHz, $V_{46} = 10\text{mV}_{RMS}$		75		dB
<b>Quality Detection</b>						
<b>S-meter, Unweighted Fieldstrength</b>						
$V_{46}$	Min. input voltage MIX2			10		$\mu\text{V}$
$\Delta V$	Per decade	SMSL = 0		1		V
$\Delta V$	Per decade	SMSL = 1		1.5		V
$V_{14}$	Fieldstrength output	$V_{46} = 0\text{V}_{RMS}$		0.1		V
$V_{14}$	Fieldstrength output	$V_{46} = 1\text{V}_{RMS}$		4.9		V
$R_{OUT}$	Output resistance			4		$\text{k}\Omega$

**ELECTRICAL CHARACTERISTICS** (continued)

$T_{amb} = +25^{\circ}\text{C}$ ,  $V_{CC1} = V_{CC2} = V_{CC3} = V_{CCVCO} = V_{CCMIX1} = 8.5\text{V}$ ,  $f_{RF} = 98\text{MHz}$ , dev. = 40kHz,  
 $f_{MOD} = 1\text{kHz}$ ,  $f_{IF1} = 10.7\text{MHz}$ ,  $f_{IF2} = 450\text{kHz}$ ,  $f_{Xtal} = 10.25\text{MHz}$ , in test or application circuit, unless otherwise specified.

Symbol	Parameter	Test Condition	Min.	Typ.	Max.	Unit
$\Delta V_{14}$	S-meter shift voltage	SL	-1.8		1.8	V
TK	Temp coeff.			0		ppm/K
<b>S-meter, Weighted Fieldstrength</b>						
$V_{35}$	Fieldstrength output	$V_{46} = 0V_{RMS}$		2.5		V
$V_{35}$	Fieldstrength output	$V_{46} = 1V_{RMS}$		4.9		V
$R_{OUT}$	Output resistance			12		$\Omega$
<b>Adjacent Channel Gain</b>						
$A_{min}$	Gain minimum	ACG		32		dB
$A_{max}$	Gain maximum	ACG		36		dB
<b>Adjacent Channel Filter</b>						
$f_{HP}$	-3dB frequency highpass	ACF		100		kHz
$f_{BP}$	Centre frequency	ACF		100		kHz
$f_{-20dB}$	Attenuation 20dB			70		kHz
<b>Adjacent Channel Output</b>						
$V_{13}$	Output voltage low			0.1		V
$V_{13}$	Output voltage high			4.9		V
$R_{OUT}$	Output resistance			4		$k\Omega$
<b>Multipath Channel Gain</b>						
$A_{min}$	Gain minimum	MPG		12		dB
$A_{max}$	Gain maximum	MPG		23		dB
<b>Multipath Bandpass Filter</b>						
$f_{Lower}$	Centre frequency low	MPF		19		kHz
$f_{Upper}$	Centre frequency up	MPF		31		kHz
Q	Quality factor		5		10	
<b>Multipath Output</b>						
$V_{34}$	Output voltage low			0.1		V
$V_{34}$	Output voltage high			4.9		V
$R_{OUT}$	Output resistance			2.5		$k\Omega$
<b>ISS (intelligent Selectivity System)</b>						
<b>Filter 450kHz</b>						
$f_{centre}$	Centre frequency	$f_{REF\_intern} = 450\text{kHz}$		450		kHz
BW 3dB	Bandwidth, -3dB	ISS80 = 1		80		kHz
BW 20dB	Bandwidth, -20dB	ISS80 = 1		150		kHz

**ELECTRICAL CHARACTERISTICS** (continued)

$T_{amb} = +25^{\circ}\text{C}$ ,  $V_{CC1} = V_{CC2} = V_{CC3} = V_{CCVCO} = V_{CCMIX1} = 8.5\text{V}$ ,  $f_{RF} = 98\text{MHz}$ , dev. = 40kHz,  
 $f_{MOD} = 1\text{kHz}$ ,  $f_{IF1} = 10.7\text{MHz}$ ,  $f_{IF2} = 450\text{kHz}$ ,  $f_{Xtal} = 10.25\text{MHz}$ , in test or application circuit, unless otherwise specified.

Symbol	Parameter	Test Condition	Min.	Typ.	Max.	Unit
BW 3dB	Bandwidth, -3dB	ISS80 = 0		120		kHz
BW 20dB	Bandwidth, -20dB	ISS80 = 0		250		kHz
BW 3dB	Bandwidth weather band	ISS30 = 1		30		kHz
BW 20dB	-20dB weather band	ISS30 = 1		80		kHz
$\Delta f_{min}$	Fine adjust	AISS		-20		kHz
$\Delta f_{max}$	Fine adjust	AISS		10		kHz
<b>Adjacent Channel ISS Filter Threshold</b>						
$V_{NTH}$	Internal low threshold	ACNTH		0		V
$V_{NTH}$	Internal high threshold	ACNTH		0.3		V
$V_{WTH}$	Internal low threshold	ACWTH		0.25		V
$V_{WTH}$	Internal high threshold	ACWTH		0.95		V
<b>Multipath Threshold</b>						
$V_{THMP}$	Internal low threshold	MPTH		0.50		V
$V_{THMP}$	Internal high threshold	MPTH		1.25		V
<b>ISS Filter Time Constant</b>						
$I_{15}$	Charge current low mid	TISS, ISSCTL = 1		-74		$\mu\text{A}$
$I_{15}$	Charge current high mid	TISS, ISSCTL = 1		-60		$\mu\text{A}$
$I_{15}$	Charge current low narrow	TISS, ISSCTL = 1		-124		$\mu\text{A}$
$I_{15}$	Charge current high narrow	TISS, ISSCTL = 1		-110		$\mu\text{A}$
$I_{15}$	Discharge current low	TISS, ISSCTL = 0		1		$\mu\text{A}$
$I_{15}$	Discharge current high	TISS, ISSCTL = 0		15		$\mu\text{A}$
$V_{15}$	Low voltage	ISSCTL = 0		0.1		V
$V_{15}$	High voltage	ISSCTL = 1		4.9		V
<b>ISS Filter Switch Threshold</b>						
$V_{15}$	Threshold ISS on	ISSCTL = 0		3		V
$V_{15}$	Threshold ISS off	ISSCTL = 0		1		V
$V_{15}$	Threshold ISS narrow on	ISSCTL = 0		4		V
$V_{15}$	Threshold ISS narrow off	ISSCTL = 0		2		V
$I_{20}$	Charge current low	TDEV		-20		$\mu\text{A}$
$I_{20}$	Charge current high	TDEV		-34		$\mu\text{A}$
$I_{20}$	Discharge current low	TDEV		6		$\mu\text{A}$
$I_{20}$	Discharge current high	TDEV		20		$\mu\text{A}$

# TDA7511

## ELECTRICAL CHARACTERISTICS (continued)

$T_{amb} = +25^{\circ}\text{C}$ ,  $V_{CC1} = V_{CC2} = V_{CC3} = V_{CCVCO} = V_{CCMIX1} = 8.5\text{V}$ ,  $f_{RF} = 98\text{MHz}$ , dev. = 40kHz,  $f_{MOD} = 1\text{kHz}$ ,  $f_{IF1} = 10.7\text{MHz}$ ,  $f_{IF2} = 450\text{kHz}$ ,  $f_{xtal} = 10.25\text{MHz}$ , in test or application circuit, unless otherwise specified.

Symbol	Parameter	Test Condition	Min.	Typ.	Max.	Unit
DEV <sub>WTH</sub>	Internal low threshold	DWTH		30		kHz
DEV <sub>WTH</sub>	Internal high threshold	DWTH		75		kHz
RATIO <sub>min</sub>	Referred to threshold	DTH		1		
RATIO <sub>max</sub>	Referred to threshold	DTH		1.5		
<b>Softmute</b>						
V <sub>ANT</sub>	Upper startpoint	SMTH, SMD, SLOPE = 0		16		dB $\mu$ V
V <sub>ANT</sub>	lower startpoint	SMTH, SMD, SLOPE = 0				dB $\mu$ V
aSM <sub>min</sub>	Min. softmute depth	SMD, SLOPE = 0, SMTH <sub>Upper</sub>		18		dB
aSM <sub>max</sub>	Max. softmute depth	SMD, SLOPE = 0, SMTH <sub>Upper</sub>		36		dB
aSMTH <sub>S</sub>	Mute depth threshold for ISS filter on	SMCTH	0.2		2	dB
V <sub>ACTH</sub>	Internal AC mute threshold	ACM	60		220	mV
aSMAC	AC mute depth			6		dB
I <sub>42</sub>	Charge current			-47.5		$\mu$ A
I <sub>42</sub>	Discharge current			2.5		$\mu$ A
<b>S/N Over All</b>						
S/N		V <sub>IN_min</sub> = 60dB $\mu$ V, dev. = 40kHz, LP=15kHz deemphasis t = 50 $\mu$ s		66		dB

## ELECTRICAL CHARACTERISTICS

$T_{amb} = +25^{\circ}\text{C}$ ,  $V_{CC1} = V_{CC2} = V_{CC3} = V_{CCVCO} = V_{CCMIX1} = V_{CCMIX2} = 8.5\text{V}$ ,  $f_{RF} = 1\text{MHz}$ ,  $f_{MOD} = 400\text{Hz}$  at 30% AM  $f_{IF1} = 10.7\text{MHz}$ ,  $f_{IF2} = 450\text{kHz}$ ,  $f_{xtal} = 10.25\text{MHz}$ , in test or application circuit, (unless otherwise noted, V<sub>inRF</sub> antenna input).

Symbol	Parameter	Test Condition	Min.	Typ.	Max.	Unit
<b>AM SECTION</b>						
<b>Global</b>						
V <sub>INRF_min</sub>	Max. sensitivity	Ref.: V <sub>INRF</sub> = 74dB $\mu$ V, $\Delta V_{37} = -10\text{dB}$		19		dB $\mu$ V
V <sub>INRF_US</sub>	Usable sensitivity	(S+N)/N = 20 dB	30	26		dB $\mu$ V
$\Delta V_{INRF}$	AGC Range	Ref.: V <sub>INRF</sub> = 74dB $\mu$ V, $\Delta V_{37} = -10\text{dB}$	51			dB
(S+N)/N	Signal to Noise Ratio	Ref.: V <sub>INRF</sub> = 74dB $\mu$ V	49	56		dB

**ELECTRICAL CHARACTERISTICS** (continued)

$T_{amb} = +25^{\circ}\text{C}$ ,  $V_{CC1} = V_{CC2} = V_{CC3} = V_{CCVCO} = V_{CCMIX1} = V_{CCMIX2} = 8.5\text{V}$ ,  $f_{RF} = 1\text{MHz}$ ,  $f_{MOD} = 400\text{Hz}$  at 30% AM,  $f_{IF1} = 10.7\text{MHz}$ ,  $f_{IF2} = 450\text{kHz}$ ,  $f_{xtal} = 10.25\text{MHz}$ , in test or application circuit, (unless otherwise noted,  $V_{inRF}$  antenna input).

Symbol	Parameter	Test Condition	Min.	Typ.	Max.	Unit
$a_{IF}$	IF rejection	Ref: $V_{inRF} = 74\text{dB}\mu\text{V}$ , IF1 = 10.7MHz IF2 = 450kHz $\Delta V_{37} = -10\text{dB}$	100 100			dB dB
$a_{TW}$	Tweet	$C_{28} = 22\mu\text{F}$	-3	-0.7		dB
$f_{AF}$	Frequency response	Ref.: $V_{inRF} = 74\text{dB}\mu\text{V}$ , $\Delta V_{AF} = -3\text{dB}$		3.6		kHz
$V_{inRFSS}$	Seek Stop Sensitivity	AMSS	20	35	45	$\text{dB}\mu\text{V}$
THD	Total Harmonic Distortion	$V_{inRF} = 74\text{dB}\mu\text{V}$ , $m = 0.8$ $m = 0.3$ $V_{inRF} = 120\text{dB}\mu\text{V}$ , $m = 0.8$ $m = 0.3$		0.5 0.3 1.0 0.3		%
$V_{37}$	Output level	$V_{inRF} = 74\text{dB}\mu\text{V}$		220		$\text{mV}_{\text{RMS}}$
$V_{34}$	Output level	$V_{inRF} = 74\text{dB}\mu\text{V}$		190		$\text{mV}_{\text{RMS}}$
$V_3$	Min. RF AGC threshold Max. RF AGC threshold	AMAGC Wide		82 98.8		$\text{dB}\mu\text{V}$ $\text{dB}\mu\text{V}$
$V_{58}$	Min. IF AGC threshold Max. IF AGC threshold	AMAGC Middle		80.1 96.8		$\text{dB}\mu\text{V}$ $\text{dB}\mu\text{V}$
$V_3$	Min. IF AGC threshold Max. IF AGC threshold	DAGC Narrow		32.6 80.7		$\text{dB}\mu\text{V}$ $\text{dB}\mu\text{V}$
$R_{63OUT}$	Output impedance			100		$\text{k}\Omega$
$R_{40OUT}$	Output impedance	AMSEEK = 0		150		$\text{k}\Omega$
$R_{40JT}$	Output impedance	AMSEEK = 1		5		$\text{k}\Omega$
<b>A3C Voltage Driver Output</b>						
$V_4$	Max. AGC output voltage		3.5			V
$V_4$	Min. AGC output voltage				0.5	V
$ I_4 $	AGC current			100		$\mu\text{A}$
<b>AGC PIN Diode Driver Output</b>						
$I_{64}$	AGC driver current			1.5		mA
<b>AM Mixer1 (10.7MHz)</b>						
$R_{IN}$	Input impedance			1.2		$\text{k}\Omega$
IP3	3rd order intercept point			140		$\text{dB}\mu\text{V}$
F	Noise figure			7		dB

## TDA7511

### ELECTRICAL CHARACTERISTICS (continued)

$T_{amb} = +25^{\circ}\text{C}$ ,  $V_{CC1} = V_{CC2} = V_{CC3} = V_{CCVCO} = V_{CCMIX1} = V_{CCMIX2} = 8.5\text{V}$ ,  $f_{RF} = 1\text{MHz}$ ,  $f_{MOD} = 400\text{Hz}$  at 30% AM,  $f_{IF1} = 10.7\text{MHz}$ ,  $f_{IF2} = 450\text{kHz}$ ,  $f_{xtal} = 10.25\text{MHz}$ , in test or application circuit, (unless otherwise noted,  $V_{inRF}$  antenna input).

Symbol	Parameter	Test Condition	Min.	Typ.	Max.	Unit
A	Gain			6		dB
$C_{min}$	Min. capacitance step	IF1T		0.55		pF
$C_{max}$	Max. capacitance	IF1T		8.25		pF
$C_{61-62}$		IF1T		2		pF
<b>AM Mixer2 (450kHz)</b>						
$R_{IN}$	Input impedance	Dependent on application		5		k $\Omega$
IP3	3rd order intercept point			15.0		dB $\mu$ V
F	Noise figure			12		dB
A	Max. gain	Mixer2 tank output		15		dB
$\Delta A$	Gain control range			20		dB
$C_{min}$	Min. cap step	IF2T		1.6		pF
$C_{max}$	Max. cap	IF2T		24		pF
$C_{55-56}$		IF2T		2		pF

### ELECTRICAL CHARACTERISTICS

Symbol	Parameter	Test Condition	Min.	Typ.	Max.	Unit
<b>ADDITIONAL PARAMETERS</b>						
<b>Outputs of Tuning Voltage(TV1, TV2)</b>						
$V_{OUT}$	Output voltage	TVR, TVO	1		$V_{CC3}-1\text{V}$	V
$R_{OUT}$	Output impedance			20		k $\Omega$
<b>Xtal Reference Oscillator</b>						
$f_{LO}$	Reference frequency	$C_{Load} = 15\text{pF}$		10.25		MHz
$C_{Step}$	Min. cap step	XTAL		0.6		pF
$C_{max}$	Max. cap	XTAL		19.4		pF
$\Delta f/f$	Freq. deviation versus $V_{CC2}$	$\Delta V_{CC2} = 1\text{V}$		1.5		ppm/V
$\Delta f/f$	Freq. deviation versus temp	$-40^{\circ}\text{C} < T < +85^{\circ}\text{C}$		0.2		ppm/K
<b>I<sup>2</sup>C-Bus interface</b>						
$f_{SCL}$	Clock frequency				400	kHz
$V_{IL}$	Input low voltage				1	V

## ELECTRICAL CHARACTERISTICS (continued)

Symbol	Parameter	Test Condition	Min.	Typ.	Max.	Unit
$V_{IH}$	Input high voltage		3			V
$I_{IN}$	Input current		-5		5	$\mu$ A
$V_O$	Output voltage SDA acknowledge	$I_O = 1.6\text{mA}$			0.4	V
<b>Loop Filter Input/Output</b>						
$-I_{IN}$	Input leakage current	$V_{IN} = \text{GND}, \text{PD}_{OUT} = \text{Tristate}$	-0.1		0.1	$\mu$ A
$I_{IN}$	Input leakage current	$V_{IN} = V_{REF1}$ $\text{PD}_{OUT} = \text{Tristate}$	-0.1		0.1	$\mu$ A
$V_{OL}$	Output voltage Low	$I_{OUT} = -0.2\text{mA}$		0.05	0.5	V
$V_{OH}$	Output voltage High	$I_{OUT} = 0.2\text{mA}$	$V_{CC3} - 0.5$	$V_{CC3} - 0.05$		V
$I_{OUT}$	Output current, sink	$V_{OUT} = 1\text{V to } V_{CC3} - 1\text{V}$			10	mA
$I_{OUT}$	Output current, source	$V_{OUT} = 1\text{V to } V_{CC3} - 1\text{V}$	-10			mA
<b>Voltage Controlled Oscillator (VCO)</b>						
$f_{VCOmin}$	Minimum VCO frequency		50			MHz
$f_{VCOmax}$	Maximum VCO frequency				200	MHz
C/N	Carrier to Noise	1% Hz offset		85		dBc
<b>SSTOP Output</b>						
$V_{24}$	Output voltage low	$I_{24} = -20\mu\text{A}$			0.2	V
$V_{24}$	Output voltage high	$I_{24} = 20\mu\text{A}$	3			V
$V_{46}$	IF counter sensitivity	Antenna input		6		dB $\mu$ V

## 1 FUNCTIONAL DESCRIPTION

### 1.1 FM Section

#### 1.2 Mixer1, AGC and 1.IF

Mixer1 is a wide dynamic range stage with low noise and large input signal performance. The mixer1 tank can be adjusted by software (IF1T). The AGC operates on different sensitivities and bandwidths (FMAGC) in order to improve the input sensitivity and dynamic range (keying AGC). The output signals of AGC are controlled voltage and current for preamplifier and prestage pin diode attenuator. (look at Figure 4)

Two 10.7MHz programmable amplifiers (IFG1, IFG2) correct the IF ceramic insertion loss and the customer level plan application.

#### 1.3 Mixer2, Limiter and Demodulator

In this 2. mixer stage the first 10.7MHz IF is converted into the second 450kHz IF. A multi-stage limiter generates signals for the complete integrated demodulator without external tank. MPX output DC offset compensation is possible by software (DEM).

#### 1.4 Quality Detection and ISS (look at Figure 2)

##### Fieldstrength

Parallel to mixer2 input a 10.7MHz limiter generates a signal for digital IF counter and a fieldstrength output signal. This internal unweighted fieldstrength is used for keying AGC, adjacent channel and multipath detection and is available at PIN14 (FSU) after +6dB buffer stage. The behaviour of this output signal can be corrected for DC offset (SL) and slope (SMSL). The internal generated unweighted fieldstrength is filtered at PIN35 and used for softmute function and generation of ISS filter switching signal for weak input level (sm).

##### Adjacent Channel Detector

The input of the adjacent channel detector is AC coupled from internal unweighted fieldstrength. A programmable highpass or bandpass (ACF) and amplifier (ACG) as well as rectifier determines the influences. This voltage is compared with adjustable comparator1 thresholds (ACWTH, ACNTH). The output signal of this comparator generates a DC level at PIN15 by programmable time constant. Time control (TISS) for a present adjacent channel is made by charge and discharge current after comparator1 in an external capacitance. The charge current is fixed and the discharge current is controlled by I<sup>2</sup>C Bus. This level produces digital signals (ac, ac+) in an additional comparator1. The adjacent channel information is available as analog output signal after rectifier and +8dB output buffer.

##### Multipath Detector

The input of the multipath detector is AC coupled from internal unweighted fieldstrength. A programmable bandpass (MPF) and amplifier (MPG) as well as rectifier determines the influences. This voltage is compared with an adjustable comparator2 thresholds (MPTH). The output signal of this comparator2 is used for the "Milano" effect. In this case the adjacent channel detection is switched off. The "Milano" effect is selectable by I<sup>2</sup>C Bus (MPOFF). The multipath information is available as analog output signal after rectifier and +8dB output buffer.

##### 450kHz IF Narrow Bandpass Filter (ISS filter)

The device gets an additional second IF narrow bandpass filter for suppression noise and adjacent channel signal influences. This narrow filter has three switchable bandwidths, narrow range of 80kHz, mid range of 120kHz and 30kHz for weather band information. Without ISS filter the IF bandwidth (wide range) is defined only by ceramic filter chain. The filter is switched in after mixer2 before 450kHz limiter stage. The centre frequency and matching to the demodulator center frequency can be fine adjusted (AISS) by software..

##### Deviation Detector

In order to avoid distortion in audio output signal the narrow ISS filter is switched OFF for present overdeviation.

Hence the demodulator output signal is detected. A lowpass filtering and peak rectifier generates a signal that is defined by software controlled current (TDEV) in an external capacitance. This value is compared with a programmable comparator3 thresholds (DWTH, DTH) and generates two digital signals (dev, dev+).

### ISS Switch Logic

All digital signals coming from adjacent channel detector, deviation detector and softmute are acting via switching matrix on ISS filter switch. The IF bandpass switch mode is controlled by software (ISSON, ISS30, ISS80, ISSCTL). The switch ON of the IF bandpass is also available by manipulation of the voltage at PIN15. Two application modes are available (APPM). The conditions are described in table 37.

### 1.5 Soft Mute Control

The external fieldstrength signal at PIN 35 is the reference for mute control. The startpoint, mute depth and slope are programmable (SMTH, SMD, SLOPE) in a wide range. The time constant is defined by external capacitance. Additional adjacent channel mute function is supported. A highpass filter with -3dB threshold frequency of 100kHz, amplifier and peak rectifier generates an adjacent noise signal from MPX output with the same time constant for softmute. This value is compared with comparator5 thresholds (ACM). For present strong adjacent channel the MPX signal is attenuated typical 6dB.

### 1.6 AM Section

The upconversion mixer1 is combined with a gain control circuit 1 sensing three input signals, narrow band information at PIN 39, upconversion signal at PIN 58 and wide band information at PIN 3. This gain control circuit gives two output signals. The first one is a current for pin diode attenuator and the second one is a voltage for preamplifier. It is possible to put in a separate narrow bandpass filter before mixer2 at PIN 58. The intervention point for first AGC (AMAGC) is programmable by software.

The oscillator frequency for mixer1 is generated by dividing the FM VCO frequency (AMD).

In mixer2 the IF1 is downconverted into the IF2 450kHz. Before the output signal reaches the 450kHz tank an attenuator for IF gain control 2 is passed. Mixer 1 and mixer2 tanks are software controlled adjustable (IF1T, IF2T).

After filtering by ceramic filter a 450kHz amplifier with a gain control 3 is included. The gain control 2 and 3 are the second AGC and programmable too by software (DAGC). In order to avoid an oscillation in intervention point it is important to know that the DAGC threshold has to be smaller than AMAGC!

The demodulator is a peak detector. A further time constant with capacitor at pin40 produces a DC AGC reference voltage dependent on input signal. The time constant is switchable by ratio of 30. This is necessary for the station search function. The switching is software controlled (AMSEEK).

An internal comparator compares the AGC voltage with a programmable reference (AMSS). Consequently it is possible to generate a seekstop impulse over a defined range.

A separate output is available for AMIF stereo or a permanent seek stop signal(SSTSEL).

### 1.7 PLL and IF Counter Section

#### PLL Frequency Synthesizer Block

This part contains a frequency synthesizer and a loop filter for the radio tuning system. Only one VCO is required to build a complete PLL system for FM and AM upconversion. For auto search stop operation an IF counter system is available.

The counter works in a two stages configuration. The first stage is a swallow counter with a two modulus (32/33) precounter. The second stage is an 11-bit programmable counter.

The circuit receives the scaling factors for the programmable counters and the values of the reference frequencies via an I<sup>2</sup>C-Bus interface. The reference frequency is generated by an adjustable internal (XTAL) oscillator followed by the reference divider. The reference and step-frequencies are free selectable (RC, PC).

Output signals of the phase detector are switching the programmable current sources. The loop filter integrates

their currents to a DC voltage.

The values of the current sources are programmable by 6 bits also received via the I<sup>2</sup>C Bus (A, B, CURRH, LPF).

To minimize the noise induced by the digital part of the system, a special guard area is implemented.

The loop gain can be set for different conditions by setting the current values of the chargepump generator.

### Frequency Generation for Phase Comparison

The RF signals applies a two modulus counter (32/33) pre-scaler, which is controlled by a 5-bit divider(A). The 5-bit register (PC0 to PC4) controls this divider. In parallel the output of the prescaler connects to an 11-bit divider(B). The 11-bit PC register (PC5 to PC15) controls this divider

Dividing range:

$$f_{OSC} = (R+1) \times f_{REF}$$

$$f_{VCO} = [33 \times A + (B + 1 - A) \times 32] \times f_{REF}$$

$$f_{VCO} = (32 \times B + A + 32) \times f_{REF}$$

Important: For correct operation:  $A \leq 32$ ;  $B \geq A$

### Three State Phase Comparator

The phase comparator generates a phase error signal according to phase difference between  $f_{SYN}$  and  $f_{REF}$ . This phase error signal drives the charge pump current generator.

### Charge Pump Current Generator

This system generates signed pulses of current. The phase error signal decides the duration and polarity of those pulses. The current absolute values are programmable by A register for high current and B register for low current.

### Inlock Detector

Switching the chargepump in low current mode can be done either via software or automatically by the inlock detector, by setting bit LDENA to "1"

After reaching a phase difference of 10 - 40nsec and a delay of some times  $1/f_{REF}$ , the chargepump is forced in low current mode. A new PLL divider alternation by I<sup>2</sup>C-Bus will switch the chargepump in the high current mode.

Few programmable phase errors (D0, D1) are available for inlock detection

The count of detected inlock informations, to release the inlock signal is adjustable (D2, D3), to avoid a switching to low current during a frequency jump.

### Low Noise CMOS Op-amp

An internal voltage divider at pin VREF2 connects the positive input of the low noise op-amp. The charge pump output connects the negative input. This internal amplifier in cooperation with external components can provide an active filter. The negative input is switchable to three input pins, to increase the flexibility in application. This feature allows two separate active filters for different applications.

A logical "0" in the LPF register activates PIN LPFM, otherwise PIN LPAM is active. While the high current mode is activated LPHC is switched on.

### IF Counter Block

The input signal for FM and AM upconversion is the same 10.7MHz IF level after limiter. The grade of integration is adjustable by eight different measuring cycle times. The tolerance of the accepted count value is adjustable, to reach an optimum compromise for search speed and precision of the evaluation.

For the FM range the center frequency of the measured count value is adjustable in 32 steps, to get the possibility of fitting the IF-filter tolerance. In the AM upconversion range an IF frequency of 10.689MHz to 10.720MHz with 1kHz steps is available.

### The IF-Counter Mode

The IF counter works in 2 modes controlled by IFCM register.

#### Sampling Timer

A sampling timer to generate the gate signal for the main counter is build with a 14-bit programmable counter (IRC). In FM mode a 6.25kHz, in AM mode a 1kHz basically signal is generated. This is followed by an asynchronous divider to generate several sampling times.

#### Intermediate Frequency Main Counter

This counter is a 11 - 21-bit synchronous autoreload down counter. Five bits (CF) are programmable to have the possibility for an adjust to the frequency of the IF-filter. The counter length is automatic adjusted to the chosen sampling time and the counter mode (FM, AM-UPC).

At the start the counter will be loaded with a defined value which is an equivalent to the divider value ( $t_{\text{Sample}} \times f_{\text{IF}}$ ).

If a correct frequency is applied to the IF counter frequency input at the end of the sampling time the main counter is changing its state from 0h to 1FFFFFFh.

This is detected by a control logic and an external search stop output is changing from LOW to HIGH. The frequency range inside which a successful count result is adjustable by the EW bits.

$$t_{\text{TIM}} = (\text{IRC} + 1) / f_{\text{OSC}}$$

$$t_{\text{CNT}} = (\text{CF} + 1697) / f_{\text{IF}} \quad \text{FM mode}$$

$$t_{\text{CNT}} = (\text{CF} + 10689) / f_{\text{IF}} \quad \text{AM up conversion mode}$$

Counter result succeeded:

$$t_{\text{TIM}} \geq t_{\text{CNT}} - t_{\text{ERR}}$$

$$t_{\text{TIM}} \leq t_{\text{CNT}} + t_{\text{ERR}}$$

Counter result failed:

$$t_{\text{TIM}} > t_{\text{CNT}} + t_{\text{ERR}}$$

$$t_{\text{TIM}} < t_{\text{CNT}} - t_{\text{ERR}}$$

$$t_{\text{TIM}} = \text{IF timer cycle time}$$

$$t_{\text{CNT}} = \text{IF counter cycle time}$$

$$t_{\text{ERR}} = \text{discrimination window (controlled by the EW registers)}$$

The IF counter is only started by inlock information from the PLL part. It is enabled by software (IFENA).

#### Adjustment of the Measurement Sequence Time

The precision of the measurements is adjustable by controlling the discrimination window. This is adjustable by programming the control registers EW0 to EW2.

The measurement time per cycle is adjustable by setting the Register IFS0 - IFS2.

#### Adjust of the Frequency Value

The center frequency of the discrimination window is adjustable by the control register CF0 to CF4.

### 1.8 I<sup>2</sup>C-Bus Interface

The TDA 7511 supports the I<sup>2</sup>C-Bus protocol. This protocol defines any device that sends data onto the bus as a transmitter, and the receiving device as the receiver. The device that controls the transfer is a master and device being controlled is the slave. The master will always initiate data transfer and provide the clock to transmit or receive operations.

#### Data Transition

Data transition on the SDA line must only occur when the clock SCL is LOW. SDA transitions while SCL is HIGH will be interpreted as START or STOP condition.

#### Start Condition

A start condition is defined by a HIGH to LOW transition of the SDA line while SCL is at a stable HIGH level. This "START" condition must precede any command and initiate a data transfer onto the bus. The TDA 7511 continuously monitors the SDA and SCL lines for a valid START and will not response to any command if this condition has not been met.

#### Stop Condition

A STOP condition is defined by a LOW to HIGH transition of the SDA while the SCL line is at a stable HIGH level. This condition terminates the communication between the devices and forces the bus-interface of the TDA 7511 into the initial condition.

#### Acknowledge

Indicates a successful data transfer. The transmitter will release the bus after sending 8 bits of data. During the 9th clock cycle the receiver will pull the SDA line to LOW level to indicate it receive the eight bits of data.

#### Data Transfer

During data transfer the TDA 7511 samples the SDA line on the leading edge of the SCL clock. Therefore, for proper device operation the SDA line must be stable during the SCL LOW to HIGH transition.

#### Device Addressing

To start the communication between two devices, the bus master must initiate a start instruction sequence, followed by an eight bit word corresponding to the address of the device it is addressing.

The most significant 6 bits of the slave address are the device type identifier.

The TDA 7511 device type is fixed as "110001".

The next significant bit is used to address a particular device of the previous defined type connected to the bus.

The state of the hardwired PIN 41 defines the state of this address bit. So up to two devices could be connected on the same bus. When PIN 41 is connected to VCC2 the address bit "1" is selected. In this case the AM part doesn't work. Otherwise the address bit "0" is selected (FM and AM is working). Therefore a double FM tuner concept is possible.

The last bit of the start instruction defines the type of operation to be performed:

- When set to "1", a read operation is selected
- When set to "0", a write operation is selected

The TDA 7511 connected to the bus will compare their own hardwired address with the slave address being transmitted, after detecting a START condition. After this comparison, the TDA 7511 will generate an "acknowledge" on the SDA line and will do either a read or a write operation according to the state of R/W bit.

**Write Operation**

Following a START condition the master sends a slave address word with the R/W bit set to "0". The TDA 7511 will generate an "acknowledge" after this first transmission and will wait for a second word (the word address field). This 8-bit address field provides an access to any of the 32 internal addresses. Upon receipt of the word address the TDA 7511 slave device will respond with an "acknowledge". At this time, all the following words transmitted to the TDA 7511 will be considered as Data. The internal address will be automatically incremented. After each word receipt the TDA 7511 will answer with an "acknowledge".

**Read Operation**

IF the master sends a slave address word with the R/W bit set to "1", the TDA 7511 will transit one 8-bit data word. This data word includes the following informations:

- bit0 (ISS filter, 1 = ON, 0 = OFF)
- bit1 (ISS filter bandwidth, 1 = 80kHz, 0 = 120kHz)
- bit2 (MPOUT, 1 = multipath present, 0 = no multipath)
- bit3 (1 = PLL is locked in , 0 = PLL is locked out).
- bit4 (fieldstrength indicator, 1 = lower as softmute threshold, 0 = higher as softmute threshold)
- bit5 (adjacent channel indicator, 1 = adjacent channel present, 0 = no adjacent channel)
- bit6 (deviation indicator, 1 = strong overdeviation present, 0 = no strong overdeviation)
- bit7 (deviation indicator, 1 = overdeviation present, 0 = no overdeviation)

**2 Software Specification**

The interface protocol comprises:

- start condition (S)
- chip address byte
- subaddress byte
- sequence of data (N bytes + Acknowledge)
- stop condition (P)

Figure 1.

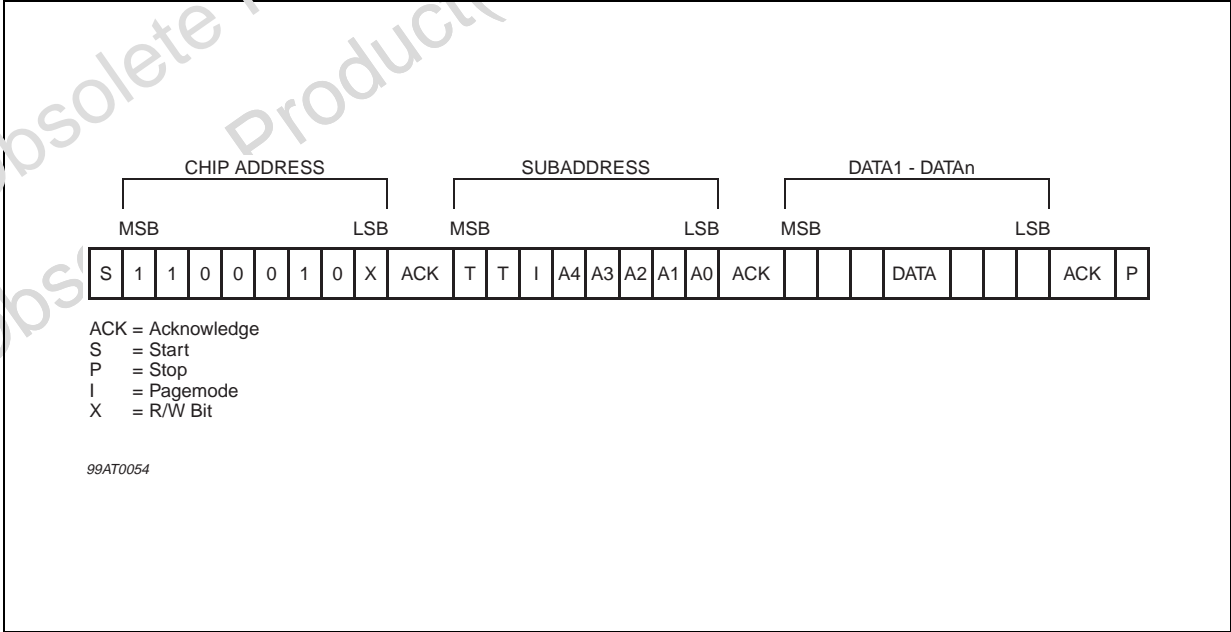

## 2.1 Address Organization

Table 1.

Function	Addr	7	6	5	4	3	2	1	0
CHARGEPU MP	0	LPF	CURRH	B1	B0	A3	A2	A1	A0
LOCKDET	1	LDENA	D3	D2	D1	D0	AMON	TEST3	RES2
PLL COUNTER	2	PC7	PC6	PC5	PC4	PC3	PC2	PC1	PC0
	3	PC15	PC14	PC13	PC12	PC11	PC10	PC9	PC8
PLL REF COUNTER	4	RC7	RC6	RC5	RC4	RC3	RC2	RC1	RC0
	5	RC15	RC14	RC13	RC12	RC11	RC10	RC9	RC8
TV1	6	TV011	TV010	TVR15	TVR14	TVR13	TVR12	TVR11	TVR10
TV2	7	TV021	TV020	TVR25	TVR24	TVR23	TVR22	TVR21	TVR20
IFC CTRL 1	8	TV013	TV012	TV023	TV022	IFENA	EW2	EV1	EW0
IFC CTRL 2	9	IFS2	IFS1	IFS0	CF4	CF3	CF2	CF1	CF0
IF REF CNT1	10	IRC7	IRC6	IRC5	IRC4	IRC3	IRC2	IRC1	IRC0
IF REF CNT2	11	IFCM1	IFCM0	IRC13	IRC12	IRC11	IRC10	IRC9	IRC8
IF1/FMAGC	12	-	FMAGC2	FMAGC1	FMAGC0	IFG21	IFG20	IFG11	IFG10
DEM ADJ	13	DNB1	DNB0	DEM5	DEM4	DEM3	DEM2	DEM1	DEM0
QUALITY AC	14	ACNTH1	ACNTH0	ACWTH2	ACWTH1	ACWTH0	ACG	ACF	ISS30
QUALITY MP	15	MPAC	APPM2	APPM1	MPTH1	MPTH0	MPG	MPF	MPOFF
QUALITYDEV	16	-	DTH1	DTH0	DWTH1	DWTH0	TDEV2	TDEV1	TDEV0
QUALITYISS	17	AISS1	AISS0	TISS2	TISS1	TISS0	ISS80	ISSON	ISSCTL
AM CTL1	18	DAGC3	DAGC2	DAGC1	DAGC0	AMD1	AMD0	AMST	AMSEEK
AM CTL2	19	AMSS3	AMSS2	AMSS1	AMSS0	AMAGC3	AMAGC2	AMAGC1	AMAGC0
MUTE1	20	SMCTH1	SMCTH0	SLOPE	MENA	SMD3	SMD2	SMD1	SMD0
MUTE2	21	ACM3	ACM2	ACM1	ACM0	SMTH3	SMTH2	SMTH1	SMTH0
SLIDER	22	-	-	SL5	SL4	SL3	SL2	SL1	SL0
TANK ADJ	23	IF1T3	IF1T2	IF1T1	IF1T0	IF2T3	IF2T2	IF2T1	IF2T0
XTAL ADJ	24	-	-	CLKSEP	XTAL4	XTAL3	XTAL2	XTAL1	XTAL0
TESTCNTRL	25	ISSIN	SMSL	SSTSEL	ISSCOFF	DEMOFF	450LOFF	TESTOUT	TESTIN
TEST	26	-	-	-	-	-	DIV2	DIV1	DIV0
TEST MODE1	27	OUT7	OUT6	OUT5	OUT4	OUT3	OUT2	OUT1	OUT0
TEST MODE2	28	-	-	TINMP	TINAC	OUT11	OUT10	OUT9	OUT8

## 2.2 Control Register Function

Table 2.

Register Name	Function
A	Charge pump high current
ACF	Adjacent channel filter select
ACG	Adjacent channel filter gain
ACM	Threshold for startpoint adjacent channel mute
ACNTH	Adjacent channel narrow band threshold
ACWTH	Adjacent channel wide band threshold
AISS	ISS filter fine adjust

Table 2. (continued)

Register Name	Function
AMAGC	AM wide band AGC threshold
AMD	AM prescaler
AMON	AM-FM switch
AMSEEK	Switch time constant for AM seek
AMSS	AM seek stop threshold
AMST	AM stereo select
APPM	Application mode quality detection
B	Charge pump low current
CF	Center frequency IF counter
CLKSEP	Clock separation (only for testing)
CURRH	Set current high charge pump
D	Inlock phase error and delay time for lock detector
DAGC	AM narrow band AGC threshold
DEM	Demodulator offset
DEMOFF	Demodulator clock "OFF" (only for testing)
DNB	Demodulator noise blanking
DIV	Divider ratio for reference frequency (only for testing)
DTH	Deviation detector threshold for ISS filter "OFF"
DWTH	Deviation detector threshold for ISS filter narrow/wide
EW	Frequency error window IF counter
FMAGC	FM AGC threshold
IF1T	FM/AM mixer1 tank adjust
IF2T	AM mixer2 tank adjust
IFCM	IF counter mode
IFENA	IF counter enable
IFG	IF1 amplifier gain (10.7MHz)
IFS	IF counter sampling time
IRC	IF reference counter
ISSCOFF	ISS filter clock "OFF" (only for testing)
ISSCT1	ISS filter control
ISSIN	Test input for ISS filter
ISSON	ISS filter "ON"
ISS30	ISS filter 30KHz weather band
ISS80	ISS filter narrow/mid switch
LDENA	Lock detector enable
LPF	Loop filter input select
MENA	Softmute enable
MPAC	Adjacent channel control by multipath
MPOFF	Multipath control "OFF"
MPF	Multipath filter frequency
MPG	Multipath filter gain
MPTH	Multipath threshold
OUT	Test output (only for testing)

Table 2. (continued)

Register Name	Function
PC	Counter for PLL (VCO frequency)
RC	Reference counter PLL
RES	Reservation
SL	S meter slider threshold
SLOPE	Softmute slope select
SMCTH	Softmute capacitor threshold for ISS "ON"
SMD	Softmute depth threshold
SMSL	S meter slope
SMTH	Softmute startpoint threshold
SSTSEL	Search stop select for continuous signal
TEST3	Testing PLL/IFC (only for testing)
TESTOUT	Switch FSW output to TEST output (only for testing)
TESTIN	Switch FSU input to TEST input (only for testing)
TDEV	Time constant for deviation detector
TINAC	Test input adjacent channel (only for testing)
TINMP	Test input multipath(only for testing)
TISS	Time constant for ISS filter "ON"/"OFF"
TVR	Tuning voltage for prestage proportional referred to PLL
TVO	Tuning voltage offset for prestage
XTAL	Xtal frequency adjust
450LOFF	450kHz limiter "OFF" (only for testing)

Subaddress

Table 3.

MSB								LSB	Function
T2	T1	I	A4	A3	A2	A1	A0		
			0	0	0	0	0	Charge pump control	
			0	0	0	0	1	PLL lock detector	
			-	-	-	-	-	-	
			1	1	1	0	0	Test mode 2	
		0						Page mode "OFF"	
		1						Page mode enable	

Note: 1. T1, T2 used for testing, in application mode they have to be "0".

### 2.3 Data Byte Specification

#### Addr 0 Charge Pump Control

Table 4.

MSB				LSB				Function
d7	d6	d5	d4	d3	d2	d1	d0	
				0	0	0	0	High current = 0mA
				0	0	0	1	High current = 0.5mA
				0	0	1	0	High current = 1mA
				0	0	1	1	High current = 1.5mA
				-	-	-	-	-
				1	1	1	1	High current = 7.5mA
		0	0					Low current = 0μA
		0	1					Low current = 50μA
		1	0					Low current = 100μA
		1	1					Low current = 150μA
	0							Select low current
	1							Select high current
0								Select LPFM
1								Select LPM

#### Addr 1 PLL Lock Detector

Table 5.

MSB				LSB				Function
d7	d6	d5	d4	d3	d2	d1	d0	
						0	0	Not used, have to be 0, d1 only for testing
						0		Select FM mode
						1		Select AM mode
			0	0				PD phase difference threshold
			0	1				10ns
			1	0				20ns
			1	1				30ns
								40ns
	0	0						Not valid
	0	1						Activation delay
	1	0						4 x 1/f <sub>REF</sub>
	1	1						6 x 1/f <sub>REF</sub>
								8 x 1/f <sub>REF</sub>
0								Lock detector doesn't control charge pump
1								Lock detector controls charge pump

## Addr 2 PLL Counter 1 (LSB)

Table 6.

MSB							LSB	Function
d7	d6	d5	d4	d3	d2	d1	d0	
0	0	0	0	0	0	0	0	LSB = 0
0	0	0	0	0	0	0	1	LSB = 1
0	0	0	0	0	0	1	0	LSB = 2
-	-	-	-	-	-	-	-	-
1	1	1	1	1	1	0	0	LSB = 252
1	1	1	1	1	1	0	1	LSB = 253
1	1	1	1	1	1	1	0	LSB = 254
1	1	1	1	1	1	1	1	LSB = 255

## Addr 3 PLL Counter 2 (MSB)

Table 7.

MSB							LSB	Function
d7	d6	d5	d4	d3	d2	d1	d0	
0	0	0	0	0	0	0	0	MSB = 0
0	0	0	0	0	0	0	1	MSB = 255
0	0	0	0	0	0	1	0	MSB = 512
-	-	-	-	-	-	-	-	-
1	1	1	1	1	1	0	0	MSB = 64768
1	1	1	1	1	1	0	1	MSB = 65024
1	1	1	1	1	1	1	0	MSB = 65280
1	1	1	1	1	1	1	1	MSB = 65536

Note: 1. Swallow mode:  $fvco/fs_{sw} = 1LSB + MSB + 32$

## Addr 4 PLL Reference Counter 1 (LSB)

Table 8.

MSB							LSB	Function
d7	d6	d5	d4	d3	d2	d1	d0	
0	0	0	0	0	0	0	0	LSB = 0
0	0	0	0	0	0	0	1	LSB = 1
0	0	0	0	0	0	1	0	LSB = 2
-	-	-	-	-	-	-	-	-
1	1	1	1	1	1	0	0	LSB = 252
1	1	1	1	1	1	0	1	LSB = 253
1	1	1	1	1	1	1	0	LSB = 254
1	1	1	1	1	1	1	1	LSB = 255

## Addr 5 PLL Reference Counter 2 (MSB)

Table 9.

MSB								LSB	Function
d7	d6	d5	d4	d3	d2	d1	d0		
0	0	0	0	0	0	0	0	MSB = 0	
0	0	0	0	0	0	0	1	MSB = 256	
0	0	0	0	0	0	1	0	MSB = 512	
-	-	-	-	-	-	-	-	-	
1	1	1	1	1	1	0	0	MSB = 64768	
1	1	1	1	1	1	0	1	MSB = 65024	
1	1	1	1	1	1	1	0	MSB = 65280	
1	1	1	1	1	1	1	1	MSB = 65536	

Note: 1.  $f_{OSC}/f_{REF} = LSB + MSB + 1$

## Addr 6, Addr7, Addr 8 TV1,2 (proportional and offset control referred to tuning voltage V28)

Table 10.

addr8		addr6								Function TV1
d7	d6	d7	d6	d5	d4	d3	d2	d1	d0	
addr8		addr7								Function TV2
d5	d4	d7	d6	d5	d4	d3	d2	d1	d0	
				0	0	0	0	0	0	TVR = 0
				0	0	0	0	0	1	TVR = -1
				0	0	0	0	1	0	TVR = -2
-	-	-	-	-	-	-	-	-	-	-
				0	1	1	1	1	1	TVR = -31
				1	0	0	0	0	1	TVR = +1
				1	0	0	0	1	0	TVR = +2
-	-	-	-	-	-	-	-	-	-	-
				1	1	1	1	1	1	TVR = +31
0	0	0	0							TVO = 0
0	0	0	1							TVO = -1
0	0	1	0							TVO = -2
-	-	-	-	-	-	-	-	-	-	-
0	1	1	1							TVO = -7
1	0	0	1							TVO = +1
1	0	1	0							TVO = +2
-	-	-	-	-	-	-	-	-	-	-
1	1	1	1							TVO = +7

Note: 1.  $TV1,2 = V28 + V28 * TVR/128 + TVO * 50mV$   
 TVR: -31, -30, ... 0 ... 30, 31  
 TVO: -7, -6, ... 0 ... 6, 7

Addr 8 IF Counter Control 1

Table 11.

MSB							LSB	Function
d7	d6	d5	d4	d3	d2	d1	d0	
					0	0	0	Not valid
					0	0	1	Not valid
					0	1	0	Not valid
					0	1	1	$\Delta f = 6.25\text{kHz}$ (FM)1kHz (AM UPC)
					1	0	0	$\Delta f = 12.5\text{kHz}$ (FM) 2kHz (AM UPC)
					1	0	1	$\Delta f = 25\text{kHz}$ (FM) 4kHz (AM UPC)
					1	1	0	$\Delta f = 50\text{kHz}$ (FM) 8kHz (AM UPC)
					1	1	1	$\Delta f = 100\text{kHz}$ (FM)16kHz (AM UPC)
				0				IF counter disable / stand by
				1				IF counter enable

Addr 9 IF Counter Control 2

Table 12.

MSB							LSB	Function
d7	d6	d5	d4	d3	d2	d1	d0	
			0	0	0	0	0	$f_{\text{Center}} = 10.60625\text{MHz}$ (FM)10.689MHz (AM UPC)
			0	0	0	0	1	$f_{\text{Center}} = 10.61250\text{MHz}$ (FM)10.690MHz (AM UPC)
-	-	-	-	-	-	-	-	-
			0	1	0	0	0	$f_{\text{Center}} = 10.66875\text{MHz}$ (FM)10.699MHz (AM UPC)
			0	1	0	0	1	$f_{\text{Center}} = 10.67500\text{MHz}$ (FM)10.700MHz (AM UPC)
			0	1	1	0	0	$f_{\text{Center}} = 10.68125\text{MHz}$ (FM)10.701MHz (AM UPC)
			0	1	1	0	1	$f_{\text{Center}} = 10.68750\text{MHz}$ (FM)10.702MHz (AM UPC)
			0	1	1	1	0	$f_{\text{Center}} = 10.69375\text{MHz}$ (FM)10.703MHz (AM UPC)
			0	1	1	1	1	$f_{\text{Center}} = 10.70000\text{MHz}$ (FM)10.704MHz (AM UPC)
			1	0	0	0	0	$f_{\text{Center}} = 10.70625\text{MHz}$ (FM)10.705MHz (AM UPC)
			1	0	0	0	1	$f_{\text{Center}} = 10.71250\text{MHz}$ (FM)10.706MHz (AM UPC)
-	-	-	-	-	-	-	-	-
			1	1	1	1	1	$f_{\text{Center}} = 10.80000\text{MHz}$ (FM)10.720MHz (AM UPC)
0	0	0						$t_{\text{Sample}} = 20.48\text{ms}$ (FM)128ms (AM UPC)
0	0	1						$t_{\text{Sample}} = 10.24\text{ms}$ (FM)64ms (AM UPC)
0	1	0						$t_{\text{Sample}} = 5.12\text{ms}$ (FM)32ms (AM UPC)
0	1	1						$t_{\text{Sample}} = 2.56\text{ms}$ (FM)16ms (AM UPC)
1	0	0						$t_{\text{Sample}} = 1.28\text{ms}$ (FM)8ms (AM UPC)
1	0	1						$t_{\text{Sample}} = 640\mu\text{s}$ (FM)4ms (AM UPC)
1	1	0						$t_{\text{Sample}} = 320\mu\text{s}$ (FM)2ms (AM UPC)
1	1	1						$t_{\text{Sample}} = 160\mu\text{s}$ (FM)1ms (AM UPC)

## Addr 10 IF Counter Reference (LSB)

Table 13.

MSB							LSB		Function
d7	d6	d5	d4	d3	d2	d1	d0		
0	0	0	0	0	0	0	0	LSB = 0	
0	0	0	0	0	0	0	1	LSB = 1	
0	0	0	0	0	0	1	0	LSB = 2	
-	-	-	-	-	-	-	-	-	
1	1	1	1	1	1	0	0	LSB = 252	
1	1	1	1	1	1	0	1	LSB = 253	
1	1	1	1	1	1	1	0	LSB = 254	
1	1	1	1	1	1	1	1	LSB = 255	

## Addr 11 IF Counter Reference (MSB) and IF Counter Mode Select

Table 14.

MSB							LSB		Function
d7	d6	d5	d4	d3	d2	d1	d0		
		0	0	0	0	0	0	MSB = 0	
		0	0	0	0	0	1	MSB = 256	
		0	0	0	0	1	0	MSB = 512	
		-	-	-	-	-	-	-	
		1	1	1	1	0	1	MSB = 15616	
		1	1	1	1	1	0	MSB = 15872	
		1	1	1	1	1	1	MSB = 16128	
0	0							Not valid	
0	1							IF counter FM mode	
1	0							Not valid	
1	1							IF counter AM upconversion mode	

Note: 1.  $f_{osc}/f_{FM} = LSB + MSB + 1$

## Addr 12 IF 1 and FM AGC

Table 15.

MSB							LSB		Function
d7	d6	d5	d4	d3	d2	d1	d0		
						0	0	IF1 gain1 9dB	
						0	1	IF1 gain1 11dB	
						1	0	IF1 gain1 13dB	
						1	1	IF1 gain1 15dB	
				0	0			IF1 gain2 9dB	
				0	1			IF1 gain2 11dB	
				1	0			IF1 gain2 13dB	
				1	1			IF1 gain2 15dB	
	0	0	0					AGC threshold 80dB $\mu$ V	
	0	0	1					AGC threshold 82dB $\mu$ V	
	0	1	0					AGC threshold 84dB $\mu$ V	
	0	1	1					AGC threshold 86dB $\mu$ V	
	1	0	0					AGC threshold 88dB $\mu$ V	
	1	0	1					AGC threshold 90dB $\mu$ V	
	1	1	0					AGC threshold 92dB $\mu$ V	
	1	1	1					Keving AGC OFF"	
0								has to be "0"	

## Addr 13 Demodulator Fine Adjust

Table 16.

MSB							LSB		Function
d7	d6	d5	d4	d3	d2	d1	d0		
		0	0	0	0	0	0	0mV	
		0	0	0	0	0	1	+6mV	
		0	0	0	0	1	0	+12mV	
		-	-	-	-	-	-	-	
		0	1	1	1	1	1	+186mV	
		1	0	0	0	0	0	0mV	
		1	0	0	0	0	1	-6mV	
		1	0	0	0	1	0	-12mV	
		-	-	-	-	-	-	-	
		1	1	1	1	1	1	-186mV	
1	1							have to be "1"	

## Addr 14 Quality Detection Adjacent Channel

Table 17.

MSB							LSB		Function
d7	d6	d5	d4	d3	d2	d1	d0		
							1	ISS filter 30KHz "ON"for weather band	
							0	AC highpass frequency 100kHz	
							1	AC bandpass frequency 100kHz	
					0			AC gain 32dB	
					1			AC gain 38dB	
		0	0	0				AC wide band threshold 0.25V	
		0	0	1				AC wide band threshold 0.35V	
		0	1	0				AC wide band threshold 0.45V	
		-	-	-				-	
		1	1	1				AC wide band threshold 0.95V	
0	0							AC narrow band threshold 0.0V	
0	1							AC narrow band threshold 0.1V	
1	0							AC narrow band threshold 0.2V	
1	1							AC narrow band threshold 0.3V	

## Addr 15 Quality Detection Multipath

Table 18.

MSB							LSB		Function
d7	d6	d5	d4	d3	d2	d1	d0		
							0	Multipath control "ON"	
							1	Multipath control "OFF"	
							0	MP bandpass frequency 19KHz	
							1	MP bandpass frequency 31KHz	
					0			MP gain 12dB	
					1			MP gain 23dB	
			0	0				MP threshold 0.50V	
			0	1				MP threshold 0.75V	
			1	0				MP threshold 1.00V	
			1	1				MP threshold 1.25V	
	0	0						Application mode 1	
	0	1						Application mode 2	
0								Multipath eliminates ac	
1								Multipath eliminates ac and ac+	

Addr 16 Quality Deviation Detection

Table 19.

MSB							LSB	Function
d7	d6	d5	d4	d3	d2	d1	d0	
					0	0	0	charge current 34µA, discharge current 6µA
					0	0	1	charge current 32µA, discharge current 8µA
					0	1	0	charge current 30µA, discharge current 10µA
					0	1	1	charge current 28µA, discharge current 12µA
					-	-	-	-
					1	1	1	charge current 20µA, discharge current 20µA
			0	0				DEV threshold for ISS narrow/wide 30kHz
			0	1				DEV threshold for ISS narrow/wide 45kHz
			1	0				DEV threshold for ISS narrow/wide 60kHz
			1	1				DEV threshold for ISS narrow/wide 75kHz
	0	0						DEV threshold for ISS filter "OFF" ratio 1
	0	1						DEV threshold for ISS filter "OFF" ratio 1.3
	1	0						DEV threshold for ISS filter "OFF" ratio 1.4
	1	1						DEV threshold for ISS filter "OFF" ratio 1.5
0								has to be 0

Addr 17 Quality ISS Filter

Table 20.

MSB							LSB	Function
d7	d6	d5	d4	d3	d2	d1	d0	
							0	ISS filter control "ON"
							1	ISS filter control "OFF"
							0	Switch ISS filter "OFF"
							1	Switch ISS filter "ON"
					0			Switch ISS filter 120kHz
					1			Switch ISS filter 80kHz
		0	0	0				discharge current1µA, charge current mid 74µA narrow124µA
		0	0	1				discharge current3µA, charge current mid 72µA narrow122µA
		0	1	0				discharge current5µA, charge current mid 70µA narrow120µA
		0	1	1				discharge current7µA, charge current mid 68µA narrow118µA
		-	-	-				-
		1	1	1				discharge current15µA,charge current mid 60µAnarrow110µA
0	0							ISS filter fine adjust -20kHz
0	1							ISS filter fine adjust -10kHz
1	0							ISS filter fine adjust 0kHz
1	1							ISS filter fine adjust +10kHz

## Addr 18 AM Control1

Table 21.

MSB							LSB	Function
d7	d6	d5	d4	d3	d2	d1	d0	
							0	Normal AGC time constant
							1	Short time constant for AM seek stop
						0		Multipath information available FM
						1		AM stereo output available
				0	0			Prescaler ratio 10
				0	1			Prescaler ratio 8
				1	0			Prescaler ratio 6
				1	1			Prescaler ratio 4
0	0	0	0					Narrow band AGC threshold 74.4dB $\mu$ V
0	0	0	1					Narrow band AGC threshold 78.8dB $\mu$ V
0	0	1	0					Narrow band AGC threshold 80.0dB $\mu$ V
0	0	1	1					Narrow band AGC threshold 80.7dB $\mu$ V
0	1	0	0					Narrow band AGC threshold 53.2dB $\mu$ V
0	1	0	1					Narrow band AGC threshold 77.1dB $\mu$ V
0	1	1	0					Narrow band AGC threshold 78.5dB $\mu$ V
0	1	1	1					Narrow band AGC threshold 79.4dB $\mu$ V
1	0	0	0					Narrow band AGC threshold 42.7dB $\mu$ V
1	0	0	1					Narrow band AGC threshold 65.8dB $\mu$ V
1	0	1	0					Narrow band AGC threshold 77.6dB $\mu$ V
1	0	1	1					Narrow band AGC threshold 78.5dB $\mu$ V
1	1	0	0					Narrow band AGC threshold 32.6dB $\mu$ V
1	1	0	1					Narrow band AGC threshold 55.0dB $\mu$ V
1	1	1	0					Narrow band AGC threshold 73.3dB $\mu$ V
1	1	1	1					Narrow band AGC threshold 77.6dB $\mu$ V

## Addr 19 AM Control2

Table 22.

MSB							LSB	Function
d7	d6	d5	d4	d3	d2	d1	d0	
				0	0	0	0	AGC Threshold 82.0dB $\mu$ V 80.1dB $\mu$ V
				0	0	0	1	AGC Threshold 85.4dB $\mu$ V 83.4dB $\mu$ V
				0	0	1	0	AGC Threshold 87.5dB $\mu$ V 85.5dB $\mu$ V
				0	0	1	1	AGC Threshold 89.2dB $\mu$ V 87.2dB $\mu$ V
				0	1	0	0	AGC Threshold 90.6dB $\mu$ V 88.6dB $\mu$ V
				0	1	0	1	AGC Threshold 91.9dB $\mu$ V 89.8dB $\mu$ V
				0	1	1	0	AGC Threshold 92.9dB $\mu$ V 90.8dB $\mu$ V
				0	1	1	1	AGC Threshold 93.8dB $\mu$ V 91.8dB $\mu$ V
				1	0	0	0	AGC Threshold 94.6dB $\mu$ V 92.6dB $\mu$ V
				1	0	0	1	AGC Threshold 95.4dB $\mu$ V 93.3dB $\mu$ V
				1	0	1	0	AGC Threshold 96.1dB $\mu$ V 94.0dB $\mu$ V

Table 22. (continued)

MSB								LSB	Function
d7	d6	d5	d4	d3	d2	d1	d0		
				1	0	1	1	AGC Threshold 96.7dB $\mu$ V 94.6dB $\mu$ V	
				1	1	0	0	AGC Threshold 97.3dB $\mu$ V 95.2dB $\mu$ V	
				1	1	0	1	AGC Threshold 97.8dB $\mu$ V 95.7dB $\mu$ V	
				1	1	1	0	AGC Threshold 98.4dB $\mu$ V 96.3dB $\mu$ V	
				1	1	1	1	AGC Threshold 98.8dB $\mu$ V 96.8dB $\mu$ V	
0	0	0	0					Seek stop threshold 20.3dB $\mu$ V	
0	0	0	1					Seek stop threshold 20.8dB $\mu$ V	
0	0	1	0					Seek stop threshold 21.3dB $\mu$ V	
0	0	1	1					Seek stop threshold 22.0dB $\mu$ V	
0	1	0	0					Seek stop threshold 22.8dB $\mu$ V	
0	1	0	1					Seek stop threshold 23.7dB $\mu$ V	
0	1	1	0					Seek stop threshold 24.7dB $\mu$ V	
0	1	1	1					Seek stop threshold 25.9dB $\mu$ V	
1	0	0	0					Seek stop threshold 27.0dB $\mu$ V	
1	0	0	1					Seek stop threshold 28.6dB $\mu$ V	
1	0	1	0					Seek stop threshold 30.4dB $\mu$ V	
1	0	1	1					Seek stop threshold 32.5dB $\mu$ V	
1	1	0	0					Seek stop threshold 35.2dB $\mu$ V	
1	1	0	1					Seek stop threshold 37.6dB $\mu$ V	
1	1	1	0					Seek stop threshold 40.2dB $\mu$ V	
1	1	1	1					Seek stop threshold 43.0dB $\mu$ V	

## Addr 20 Softmute Control

Table 23.

MSB								LSB	Function
d7	d6	d5	d4	d3	d2	d1	d0		
				0	0	0	0	Mute depth 0 in application 18dB	
				0	0	0	1	Mute depth 1 in application 20dB	
				0	0	1	0	Mute depth 2 in application 22dB	
				0	0	1	1	Mute depth 3 in application 24dB	
				-	-	-	-	- (logarithmically behaviour)	
				1	1	1	1	Mute depth 15 in application 36dB	
			0					Mute disable	
			1					Mute enable	
		0						Sharp slope	
		1						Smooth slope	
0	0							Function "OFF"	
0	1							Mute depth threshold for ISS filter "ON" 2dB	
1	0							Mute depth threshold for ISS filter "ON" 1dB	
1	1							Mute depth threshold for ISS filter "ON" 0.2dB	

## Addr 21 Softmute Control 2

Table 24.

MSB							LSB		Function
d7	d6	d5	d4	d3	d2	d1	d0		
				0	0	0	0	Startpoint mute 0 in application 3dB $\mu$ V	
				0	0	0	1	Startpoint mute 1 in application 4dB $\mu$ V	
				0	0	1	0	Startpoint mute 2 in application 5dB $\mu$ V	
				0	1	0	0	Startpoint mute 3 in application 6dB $\mu$ V	
				-	-	-	-	-	
				1	1	1	1	Startpoint mute 15 in application 18dB $\mu$ V	
0	0	0	0					AC mute threshold 60mV	
0	0	0	1					AC mute threshold 80mV	
0	0	1	1					AC mute threshold 100mV	
-	-	-	0					-	
1	0	0	0					AC mute threshold 220mV	
1	1	1	1					AC mute "OFF"	

## Addr 22 S-Meter Slider

Table 25.

MSB							LSB		Function
d7	d6	d5	d4	d3	d2	d1	d0		
		0	0	0	0	0	0	S meter offset 0mV	
		0	0	0	0	0	1	S meter offset -58mV	
		0	0	0	0	1	0	S meter offset -116mV	
		-	-	-	-	-	-	-	
		0	1	1	1	1	1	S meter offset -1798mV	
		1	0	0	0	0	0	S meter offset 0mV	
		1	0	0	0	0	1	S meter offset +58mV	
		1	0	0	0	1	0	S meter offset +116mV	
		-	-	-	-	-	-	-	
		1	1	1	1	1	1	S meter offset +1798mV	
	x							Not used	

Addr 23 Tank Adjust

Table 26.

MSB							LSB		Function
d7	d6	d5	d4	d3	d2	d1	d0		
				0	0	0	0	450kHz 0pF	
				0	0	0	1	450kHz 1.6pF	
				0	0	1	0	450kHz 3.2pF	
				0	0	1	1	450kHz 4.8pF	
				-	-	-	-	-	
				1	1	1	1	450kHz 24pF	
0	0	0	0					10.7MHz 0pF	
0	0	0	1					10.7MHz 0.55pF	
0	0	1	0					10.7MHz 1.1pF	
0	0	1	1					10.7MHz 1.65pF	
-	-	-	-					-	
1	1	1	1					10.7MHz 8.25pF	

Addr 24 XTAL Adjust

Table 27.

MSB							LSB		Function
d7	d6	d5	d4	d3	d2	d1	d0		
			0	0	0	0	0	C <sub>Load</sub> 0pF	
			0	0	0	0	1	C <sub>Load</sub> 0.625pF	
			0	0	0	1	0	C <sub>Load</sub> 1.25pF	
			0	0	0	1	1	C <sub>Load</sub> 1.875pF	
			0	0	1	0	0	C <sub>Load</sub> 2.5pF	
			-	-	-	-	-	-	
			1	1	1	1	1	C <sub>Load</sub> 19.4pF	
		0						Only for testing has to be "0"	
x	x							Not used	

Addr 25 Test Control

Table 28.

MSB							LSB		Function
d7	d6	d5	d4	d3	d2	d1	d0		
			0	0	0	0	0	Only for testing (bits have to be "0")	
		0						AMIF select	
		1						Permanent search stop select for AM	
	0							S meter slope 1V/decade	
	1							S meter slope 1.5V/decade	
0								Only for testing (has to be "0")	

**Addr 26 Test****Table 29.**

MSB							LSB	Function
d7	d6	d5	d4	d3	d2	d1	d0	
x	x	x	x	x	1	1	0	Only for testing (bits have to be set)

**Addr 27 Test Mode1****Table 30.**

MSB							LSB	Function
d7	d6	d5	d4	d3	d2	d1	d0	
0	0	0	0	0	0	0	0	Only for testing (bits have to be set)

**Addr 28 Test Mode2****Table 31.**

MSB							LSB	Function
d7	d6	d5	d4	d3	d2	d1	d0	
x	x	0	0	0	0	0	0	Only for testing (bits have to be set)

APPENDIX

Figure 2.

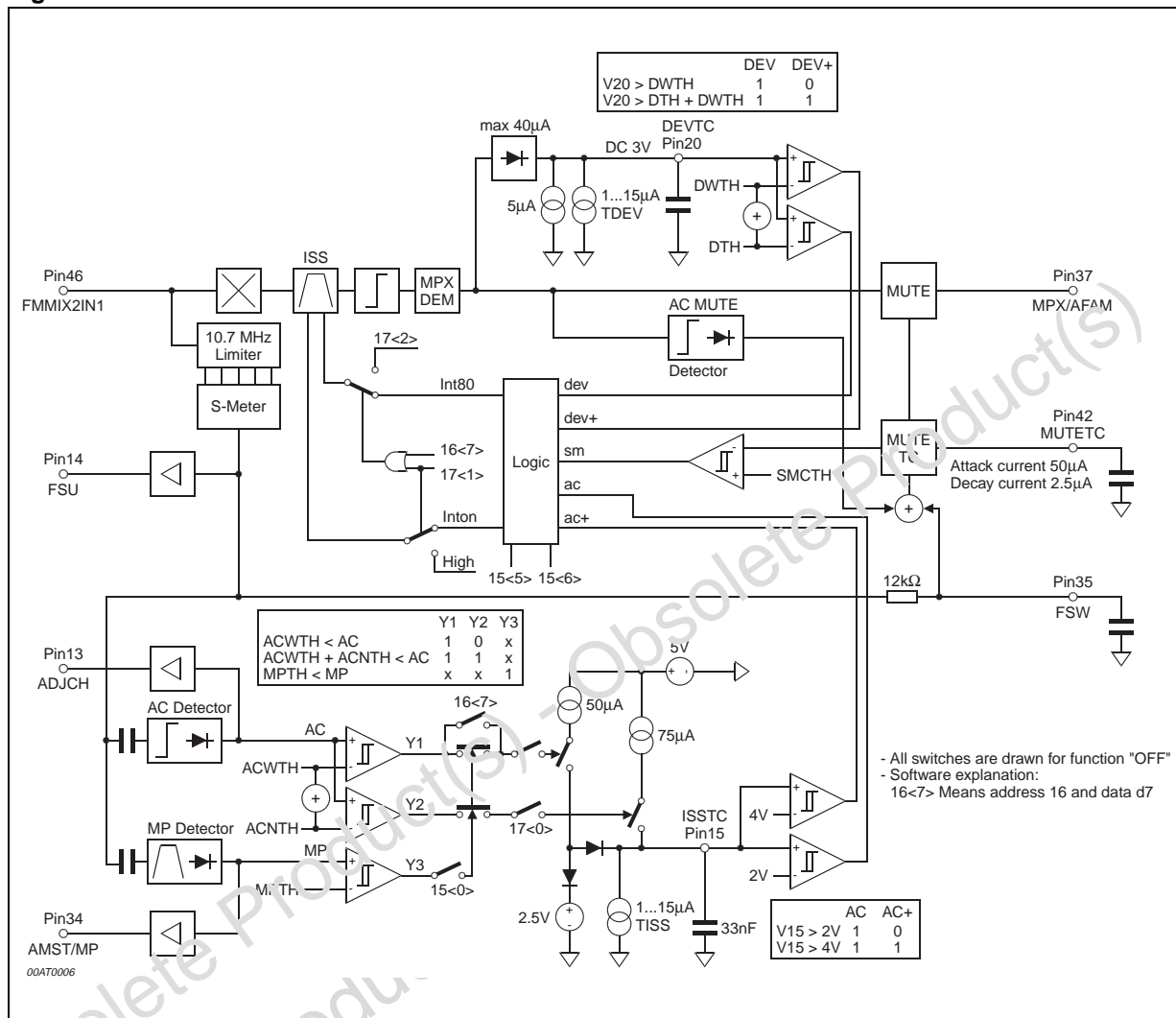
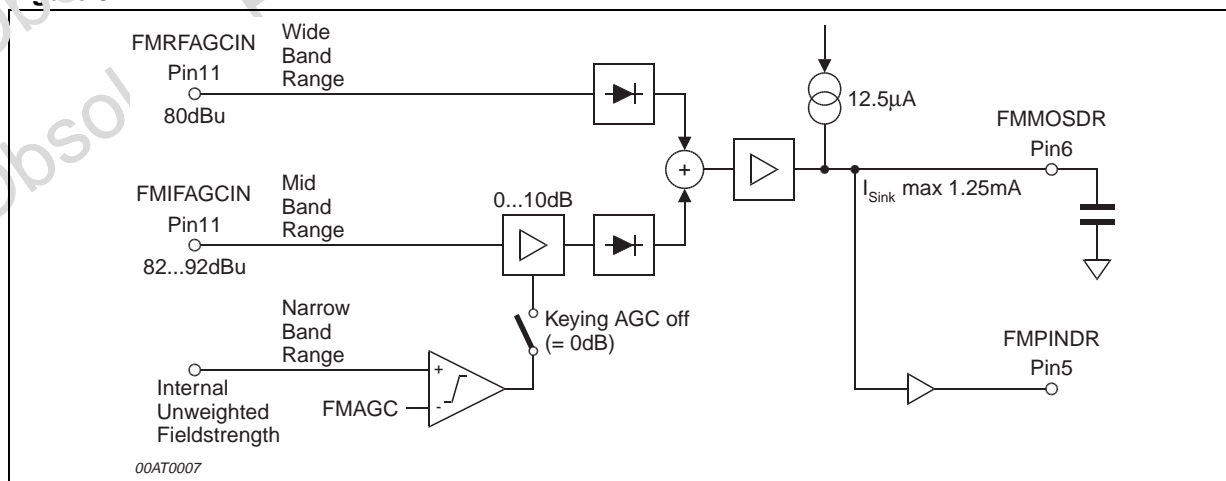

Figure 3.



## Block Diagram Quality Detection Principle

Table 32.

Signal	LOW	HIGH
ac	No adjacent channel	Adjacent channel present
ac+	No strong adjacent channel	Adjacent channel higher as ac
sm	Fieldstrength higher as softmute threshold	Fieldstrength lower as softmute threshold
dev	Deviation lower as threshold DWTH	Deviation higher as threshold DWTH
dev+	Deviation lower as threshold DTH*DWTH	Deviation higher as threshold DTH*DWTH
inton	ISS filter off by logic (wide)	ISS filter on by logic
int80	ISS filter 120kHz (mid)	ISS filter 80kHz (narrow)

Table 33.

Input Signals					Mode1			Mode2		
ac	ac+	sm	dev	dev+	inton	int80	Function	inton	int80	Function
0	0	0	0	0	0	0	wide	0	0	wide
0	0	0	1	0	0	0	wide	0	0	wide
0	0	0	1	1	0	0	wide	0	0	wide
0	0	1	0	0	1	1	narrow	1	1	narrow
0	0	1	1	0	0	0	wide	1	0	mid
0	0	1	1	1	0	0	wide	0	0	wide
1	0	0	0	0	1	1	narrow	1	0	mid
1	1	0	0	0	1	1	narrow	1	1	narrow
1	0	0	1	0	1	0	mid	1	0	mid
1	1	0	1	1	1	0	mid	1	1	narrow
1	0	1	0	0	1	1	narrow	1	1	narrow
1	1	1	0	0	1	1	narrow	1	1	narrow
1	0	1	1	0	1	0	mid	1	0	mid
1	1	1	1	0	1	0	mid	1	1	narrow
1	0	1	1	1	1	0	mid	1	0	mid
1	1	1	1	1	1	0	mid	1	1	narrow

## Part List (Application- and Measurement Circuit)

Table 34.

Item	Description
F1	TOKO 7KL 600ENS-9132NK
F2	TOKO 7KL 600ENS-9390AQ
F3	TOKO 7KL V600ENS-9469BS
F4	TOKO 7PSG 628AC-5022N
F5	TOKO PGL 5PGLC-5103N
L1,L5	SIEMENS SIMID03 B82432 1mH
L2,L4	TOKO FSLU 2520-680 68µH
L3	TOKO FSLU 2520-150 15µH
CF1,CF2	MURATA SFE10.7MS3A10-A 180KHz or (TOKO CFSK107M3-AE-20X)
CF3	MURATA SFE10.7MJA10-A 150KHz or (TOKO CFSK107M4-AE-20X)
CF4	MURATA SFPS 450H 6KHz or (TOKO ARLFC450T)
T1,T2	COMPONEX B4F 617PT-1026
D1,D3,D5	TOKO KV1410
D2,D4	TOSHIBA 1SV172
Q1	TOSHIBA 3SK126
Q2	TOSHIBA HN3G01J

3 APPLICATION CIRCUIT

Figure 4.

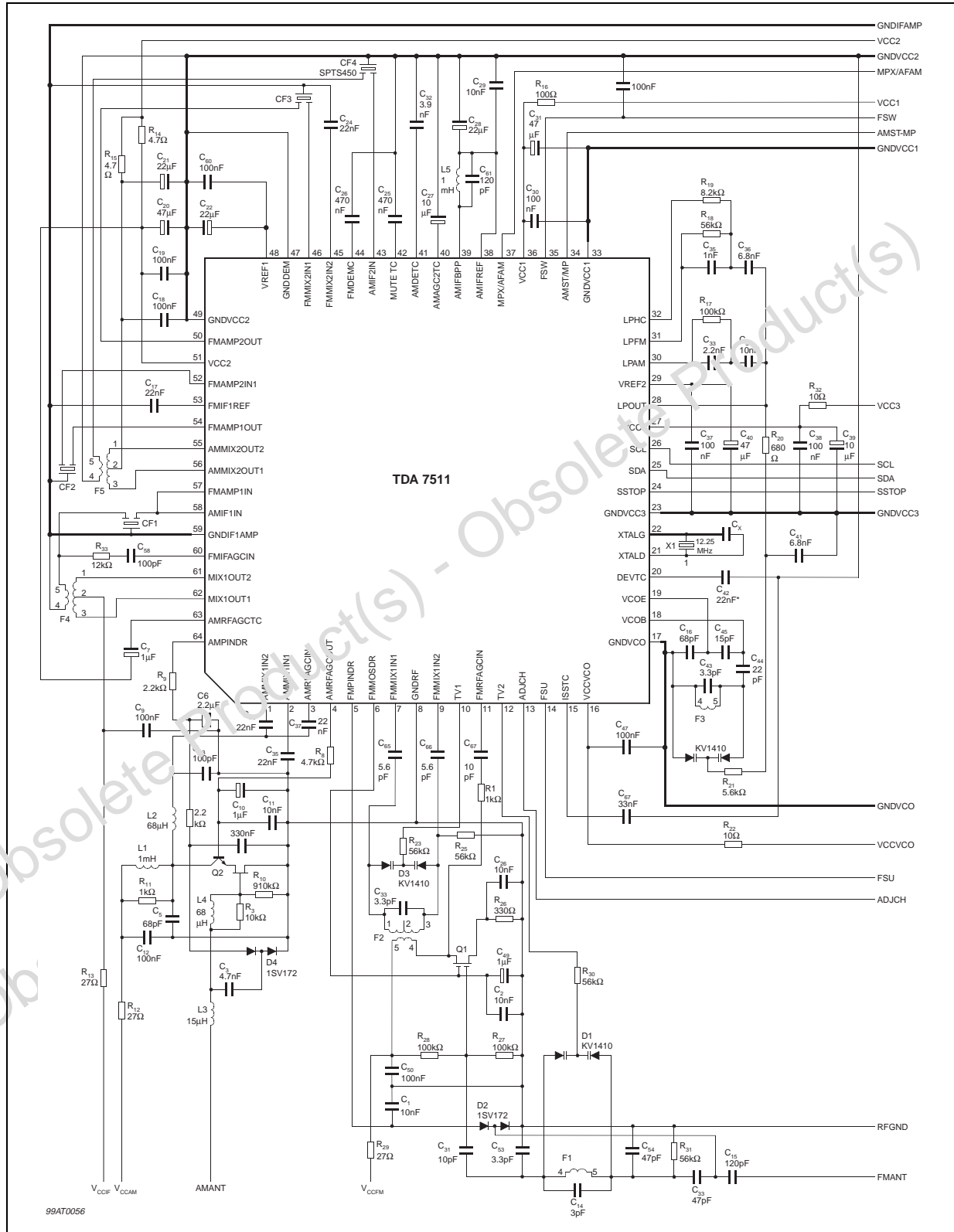



DIM.	mm			inch		
	MIN.	TYP.	MAX.	MIN.	TYP.	MAX.
A			1.60			0.063
A1	0.05		0.15	0.002		0.006
A2	1.35	1.40	1.45	0.053	0.055	0.057
B	0.18	0.23	0.28	0.007	0.009	0.011
C	0.12	0.16	0.20	0.0047	0.0063	0.0079
D		12.00			0.472	
D1		10.00			0.394	
D3		7.50			0.295	
e		0.50			0.0197	
E		12.00			0.472	
E1		10.00			0.394	
E3		7.50			0.295	
L	0.40	0.60	0.75	0.0157	0.0236	0.0295
L1		1.00			0.0393	
K	0°(min.), 7°(max.)					

**OUTLINE AND MECHANICAL DATA**

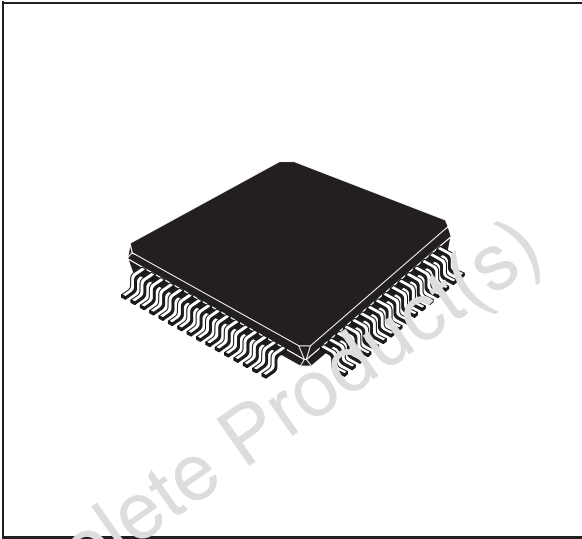

**TQFP64**

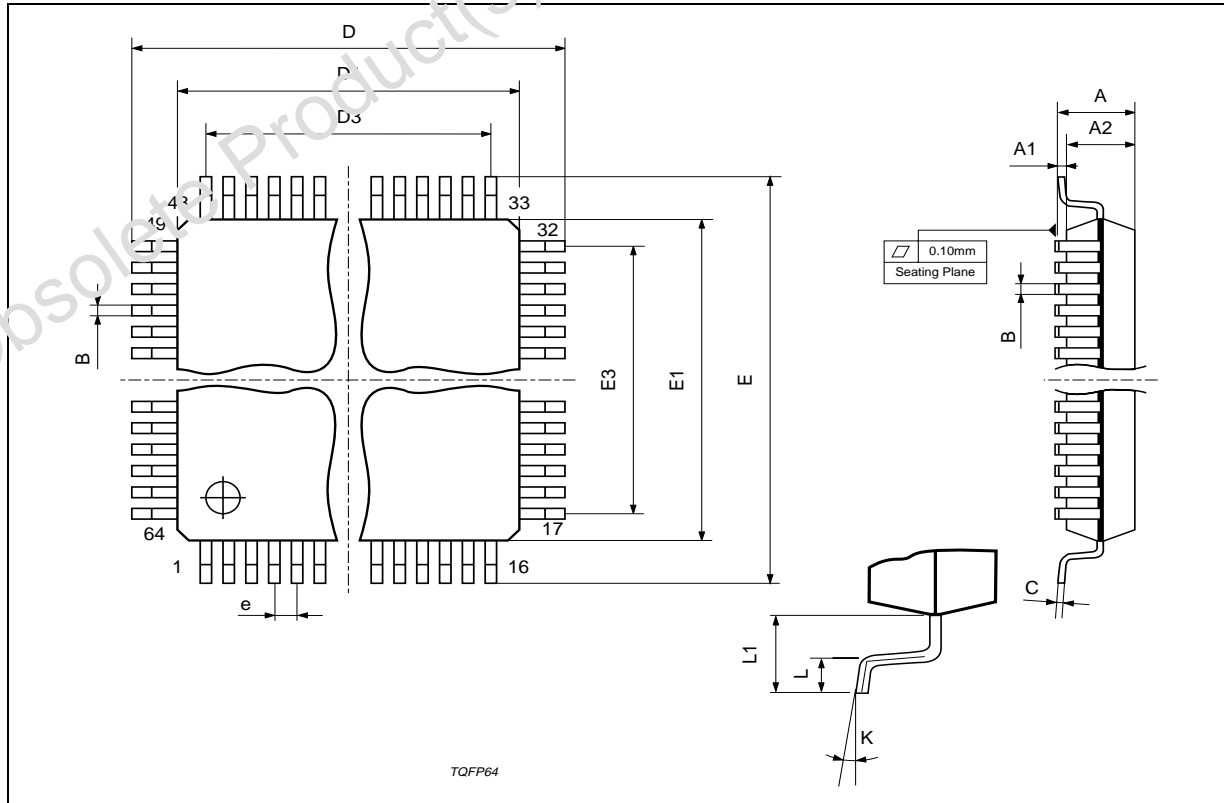

Obsolete Product(s) - Obsolete Product(s)  
Obsolete Product(s) - Obsolete Product(s)

Information furnished is believed to be accurate and reliable. However, STMicroelectronics assumes no responsibility for the consequences of use of such information nor for any infringement of patents or other rights of third parties which may result from its use. No license is granted by implication or otherwise under any patent or patent rights of STMicroelectronics. Specifications mentioned in this publication are subject to change without notice. This publication supersedes and replaces all information previously supplied. STMicroelectronics products are not authorized for use as critical components in life support devices or systems without express written approval of STMicroelectronics.

The ST logo is a registered trademark of STMicroelectronics  
© 2001 STMicroelectronics - All Rights Reserved



STMicroelectronics GROUP OF COMPANIES

Australia - Brazil - Canada - China - Finland - France - Germany - Hong Kong - India - Israel - Italy - Japan - Malaysia - Malta - Morocco - Singapore - Spain - Sweden - Switzerland - United Kingdom - United States.





<http://www.st.com>

## Looking for pricing, stock, or lifecycle information?

Click below to explore more details on WIN SOURCE:

-  [View TDA7511](#) on WIN SOURCE
-  [STMicroelectronics](#) Information

## Optimize Your Supply Chain with WIN SOURCE Solutions

-  Global Sourcing Solution
-  Obsolete Management
-  Cost Control Management
-  Shortage Management
-  Alternative Solution
-  Excess Inventory Management