

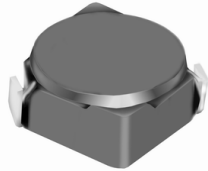

**THE DATASHEET OF
CDRH4D22HPNP-6R3NC**



SMD Power Inductor CDRH4D22/HP



Description

- Ferrite drum core construction.
- Magnetically shielded.
- L × W × H: 5.0 × 5.0 × 2.4 mm Max.
- Product weight: 0.2g(Ref.)
- Moisture Sensitivity Level: 1
- RoHS compliance.

Environmental Data

- Operating temperature range: -40°C ~ +100°C (including coil's self temperature rise)
- Storage temperature range: -40°C ~ +100°C
- Solder reflow temperature: 260 °C peak.

Packaging

- Carrier tape and reel packaging
- 12.9" diameter reel
- 2000pcs per reel

Applications

- Ideally used in Mobile phone, PDA, MP3, HDD, DSC/DVC, Portable Computers, etc as DC-DC converter inductors.

Dimension - [mm]

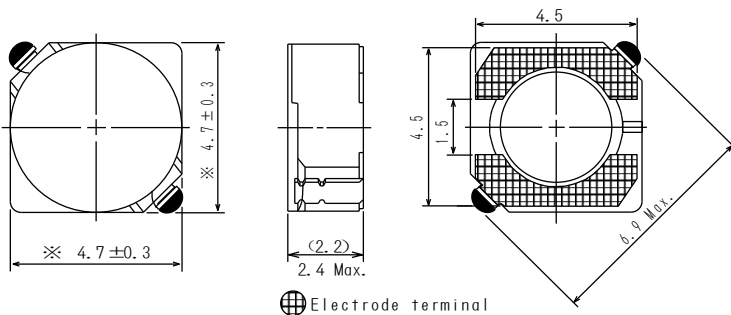

Land pattern and Schematics - [mm]

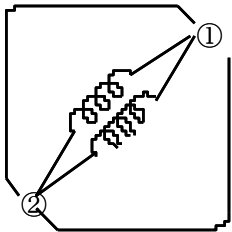
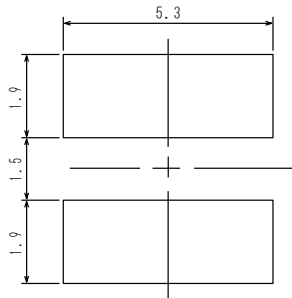

(1.2µH ~ 5.2µH)

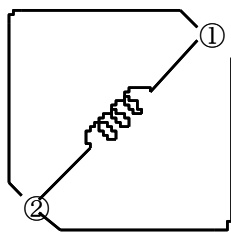

(6.3µH ~ 100µH)



Electrical Characteristics

Part Name	Stamp	Inductance (μ H) [within] ※1	D.C.R. (m Ω) Max. (Typ.) (at 20°C)	Saturation Current (A) ※2		Temperature Rise Current (A) ※3
				at 20°C	at 100°C	
CDRH4D22HPNP-1R2NC	1R2	1.2 \pm 25%	26.5(21.2)	4.20	3.40	3.20
CDRH4D22HPNP-1R5NC	1R5	1.5 \pm 25%	31.3(25.0)	3.90	3.20	3.00
CDRH4D22HPNP-2R2NC	2R2	2.2 \pm 25%	44.3(35.4)	3.20	2.50	2.40
CDRH4D22HPNP-2R7NC	2R7	2.7 \pm 25%	57.8(46.3)	2.80	2.35	2.20
CDRH4D22HPNP-3R5NC	3R5	3.5 \pm 25%	65.1(52.0)	2.50	2.10	2.00
CDRH4D22HPNP-4R7NC	4R7	4.7 \pm 25%	82.6(66.0)	2.20	1.80	1.80
CDRH4D22HPNP-5R2NC	5R2	5.2 \pm 25%	92.8(74.3)	2.00	1.65	1.70
CDRH4D22HPNP-6R3NC	6R3	6.3 \pm 25%	110.0(87.9)	1.85	1.50	1.40
CDRH4D22HPNP-8R2NC	8R2	8.2 \pm 25%	128.3(102.6)	1.65	1.40	1.35
CDRH4D22HPNP-100MC	100	10 \pm 20%	143.8(115.0)	1.50	1.20	1.30
CDRH4D22HPNP-120MC	120	12 \pm 20%	187.2(150.0)	1.30	1.10	1.10
CDRH4D22HPNP-150MC	150	15 \pm 20%	212.9(170.3)	1.20	1.00	0.85
CDRH4D22HPNP-180MC	180	18 \pm 20%	238.7(191.0)	1.10	0.90	0.80
CDRH4D22HPNP-220MC	220	22 \pm 20%	267.0(213.6)	1.05	0.85	0.75
CDRH4D22HPNP-270MC	270	27 \pm 20%	393.9(315.0)	0.90	0.75	0.70
CDRH4D22HPNP-330MC	330	33 \pm 20%	448.9(359.0)	0.80	0.68	0.65
CDRH4D22HPNP-390MC	390	39 \pm 20%	667.9(534.3)	0.75	0.60	0.52
CDRH4D22HPNP-470MC	470	47 \pm 20%	723.3(578.6)	0.70	0.56	0.50
CDRH4D22HPNP-560MC	560	56 \pm 20%	810.0(648.2)	0.65	0.52	0.48
CDRH4D22HPNP-680MC	680	68 \pm 20%	913.0(730.4)	0.60	0.48	0.45
CDRH4D22HPNP-820MC	820	82 \pm 20%	1221(977.0)	0.55	0.45	0.40
CDRH4D22HPNP-101MC	101	100 \pm 20%	1370(1096.0)	0.48	0.38	0.35

※1. Inductance measuring condition: at 100kHz.

※2. Saturation current: The value of D.C. current when the inductance decreases to 65% of it's nominal value.

※3. Temperature rise current: The value of D.C. current when the temperature rise is $\Delta t=40^{\circ}\text{C}$ ($T_a=20^{\circ}\text{C}$).

SMD Power Inductor CDRH4D22/HP



Saturation Current & Temperature Rise Graph

— L (20°C) — L (105°C) — ΔT

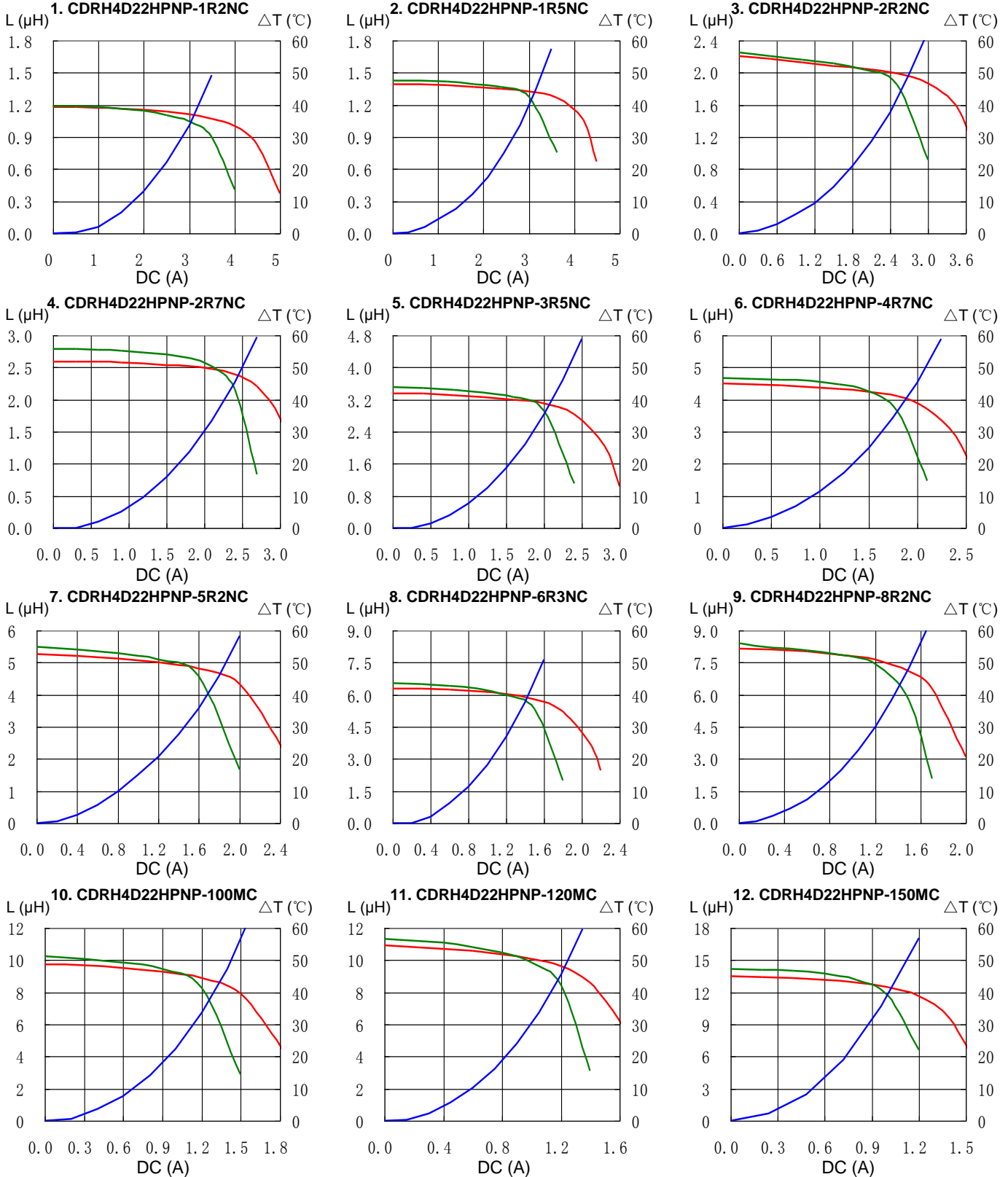

SMD Power Inductor CDRH4D22/HP



Saturation Current & Temperature Rise Graph

— L (20°C) — L (105°C) — ΔT

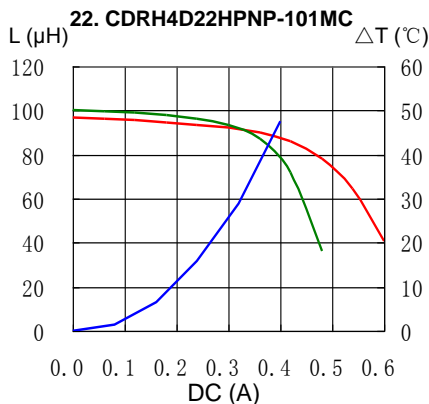
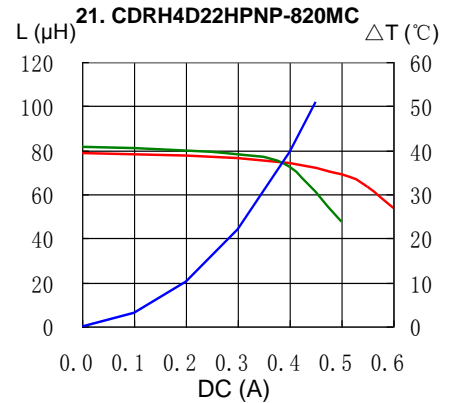
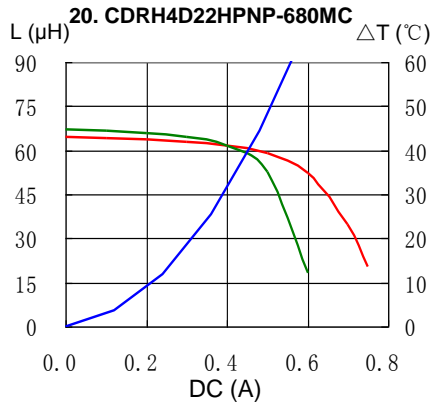
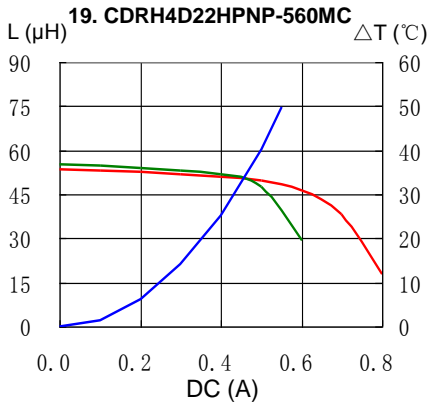
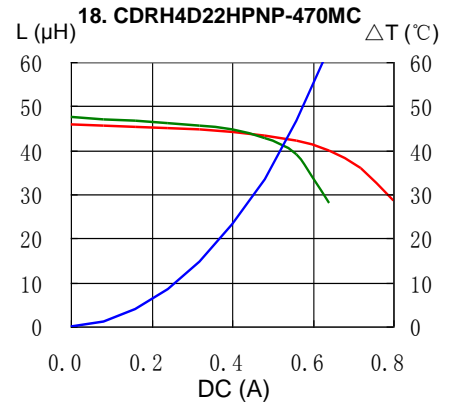
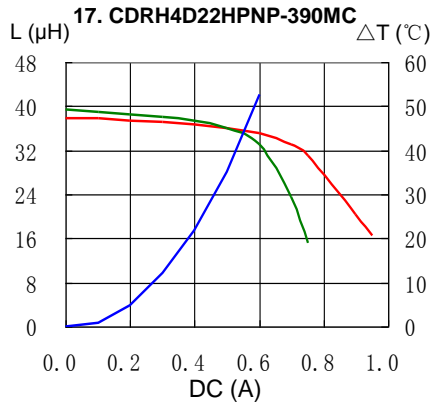
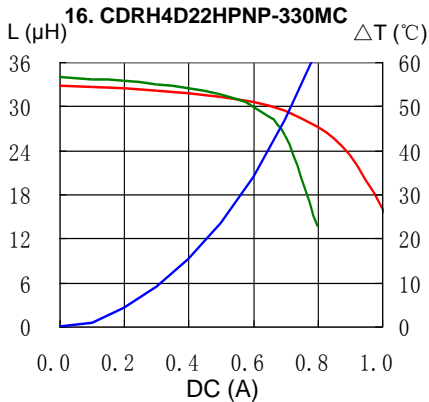
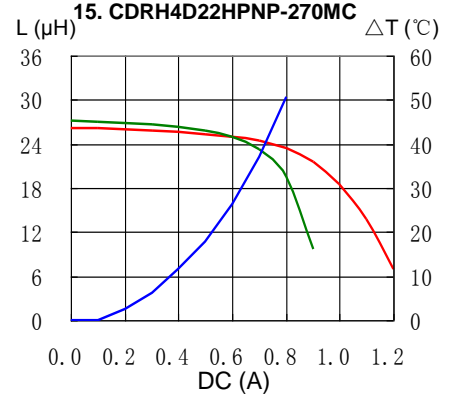
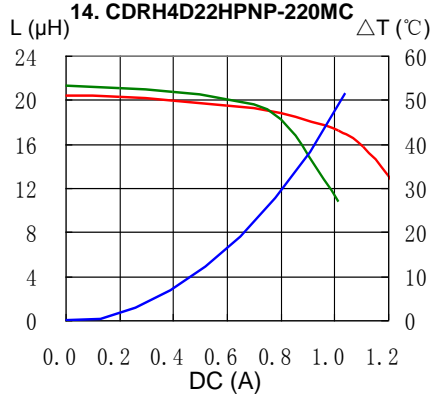
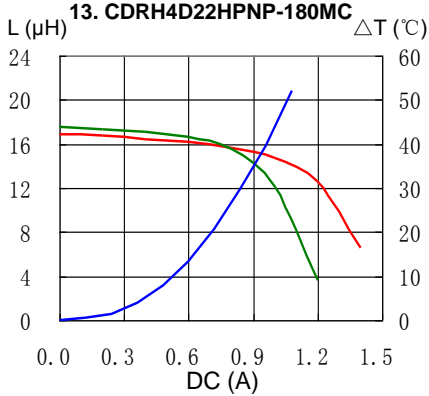

SMD Power Inductor CDRH4D22/HP



Solder Reflow Condition

Heat Endurance

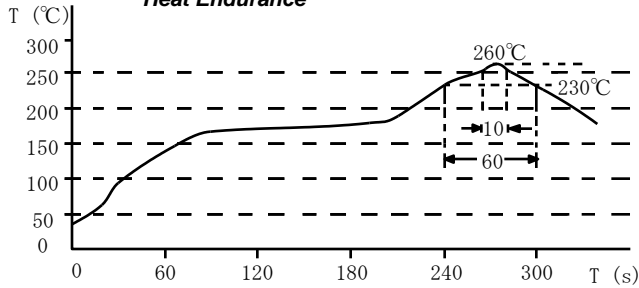

Temperature Chart

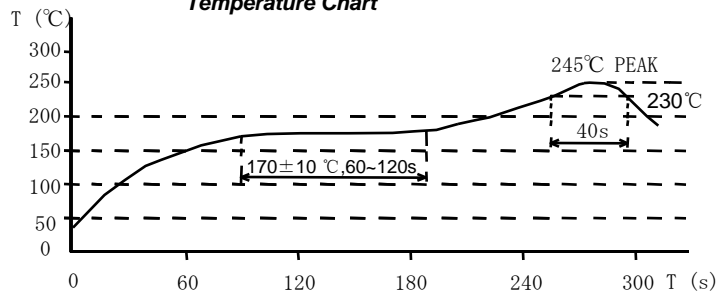

Please refer to the sales offices on our website - <http://www.sumida.com>

Hong Kong

Tel. +852-2880-6781
FAX. +852-2565-9600
sales@hk.sumida.com

Saitama(Japan)

Tel. +81-48-691-7300
FAX. +81-48-691-7340
sales@jp.sumida.com

Chicago

Tel. +1-847-545-6700
FAX. +1-847-545-6720
sales@us.sumida.com

Shanghai

Tel. +86-21-5836-3299
FAX. +86-21-5836-3266
shanghai.sales@cn.sumida.com

Seoul

Tel. +82-2-6237-0777
FAX. +82-2-6237-0778
sales@kr.sumida.com

Obernzell

Tel. +49-8591-937-0
FAX. +49-8591-937-103
contact@eu.sumida.com

Shenzhen

Tel. +86-755-8291-0228
FAX. +86-755-8291-0338
shenzhen.sales@cn.sumida.com

Singapore

Tel. +65-6296-3388
FAX. +65-6841-4426
sales@sg.sumida.com

Neumarkt

Tel. +49-9181-4509-110
FAX. +49-9181-4509-310
infocomp@eu.sumida.com

Taipei

Tel. +886-2-8751-2737
FAX. +886-2-8751-2738
sales@tw.sumida.com

San Jose

Tel. +1-408-321-9660
FAX. +1-408-321-9308
sales@us.sumida.com

Looking for pricing, stock, or lifecycle information?

Click below to explore more details on WIN SOURCE:

- ⊖ [View CDRH4D22HPNP-6R3NC on WIN SOURCE](#)
- ⊖ [Sumida America Components Inc. Information](#)

Optimize Your Supply Chain with WIN SOURCE Solutions

- ✓ Global Sourcing Solution
- ✓ Obsolete Management
- ✓ Cost Control Management
- ✓ Shortage Management
- ✓ Alternative Solution
- ✓ Excess Inventory Management