



# THE DATASHEET OF NCP4300AD



# NCP4300A

## Dual Operational Amplifier and Voltage Reference

The NCP4300A is a monolithic integrated circuit specifically designed to control the output current and voltage levels of switch mode battery chargers and power supplies. This device contains a precision 2.6 V shunt reference and two operational amplifiers. Op-Amp 1 is designed to perform voltage control and has its non-inverting input internally connected to the reference. Op-Amp 2 is designed for current control and has both inputs uncommitted. The NCP4300A offers the power converter designer a control solution that features increased precision with a corresponding reduction in system complexity and cost. This device is available in an 8-lead surface mount package.

### Features

- This is a Pb-Free Device

### Operational Amplifier

- Low Input Offset Voltage: 0.5 mV
- Input Common Mode Voltage Range Includes Ground
- Low Supply Current: 210  $\mu$ A/Op-Amp (@ $V_{CC} = 5.0$  V)
- Medium Unity Gain Bandwidth: 0.7 MHz
- Large Output Voltage Swing: 0 V to  $V_{CC} - 1.5$  V
- Wide Power Supply Voltage Range: 3.0 V to 35 V

### Voltage Reference

- Fixed Output Voltage Reference: 2.60 V
- High Precision Over Temperature: 1.0%
- Wide Sink Current Range: 80  $\mu$ A to 80 mA

### Typical Applications

- Battery Charger
- Switch Mode Power Supply

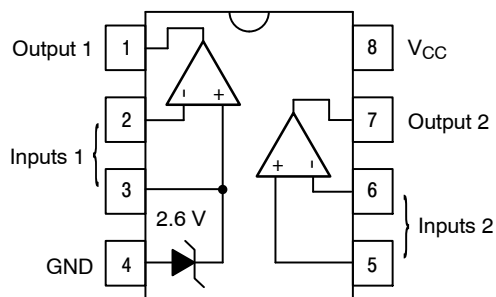


Figure 1. Functional Block Diagram



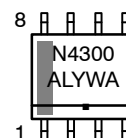
ON Semiconductor®

<http://onsemi.com>

### MARKING DIAGRAM

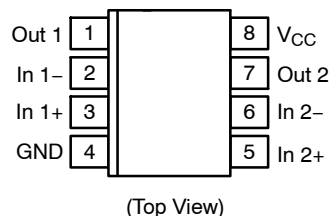


SOIC-8  
D SUFFIX  
CASE 751



A = Assembly Location  
L = Wafer Lot  
Y = Year  
W = Work Week  
A = Option Code  
▪ = Pb-Free Package

### PIN CONNECTIONS



### ORDERING INFORMATION

Device	Package	Shipping†
NCP4300ADG	SOIC-8 (Pb-Free)	98 Units / Rail
NCP4300ADR2G	SOIC-8 (Pb-Free)	2500/Tape & Reel

†For information on tape and reel specifications, including part orientation and tape sizes, please refer to our Tape and Reel Packaging Specification Brochure, BRD8011/D.

# NCP4300A

## ABSOLUTE MAXIMUM RATINGS

Rating	Symbol	Value	Unit
Supply Voltage ( $V_{CC}$ to GND)	$V_{CC}$	36	V
ESD Protection Voltage at any Pin (Human Body Model)	$V_{ESD}$	2.0 K (min)	V
Op-Amp 1 and 2 Input Voltage Range (Pins 2, 5, 6)	$V_{IR}$	-0.6 to $V_{CC} + 0.6$	V
Op-Amp 2 Input Differential Voltage Range (Pins 5, 6)	$V_{IDR}$	$V_{CC}$ to GND	V
Voltage Reference Cathode Current (Pin 3)	$I_K$	100	mA
Maximum Junction Temperature	$T_J$	150	°C
Operating Ambient Temperature Range	$T_A$	0 to 105	°C
Storage Temperature Range	$T_{stg}$	-55 to 150	°C

Stresses exceeding Maximum Ratings may damage the device. Maximum Ratings are stress ratings only. Functional operation above the Recommended Operating Conditions is not implied. Extended exposure to stresses above the Recommended Operating Conditions may affect device reliability.

## THERMAL CHARACTERISTICS

Rating	Symbol	Value	Unit
Thermal Resistance, Junction-to-Ambient	$R_{\theta JA}$	155	°C/W
Thermal Resistance, Junction-to-Case	$R_{\theta JC}$	45	°C/W

## TYPICAL ELECTRICAL CHARACTERISTICS

Characteristic	Symbol	Min	Typ	Max	Unit
Total Supply Current, excluding Current in the Voltage Reference $V_{CC} = 5.0$ V, no load; $0^\circ\text{C} \leq T_A \leq 105^\circ\text{C}$	$I_{CC}$	-	0.42	0.8	mA

### Op-Amp 1 (Op-amp with non-inverting input connected to the internal Vref)

( $V_{CC} = 5.0$  V,  $V_{out} = 1.4$  V,  $T_A = 25^\circ\text{C}$ , unless otherwise noted)

Input Offset Voltage $T_A = 25^\circ\text{C}$ $T_A = 0^\circ\text{C}$ to $105^\circ\text{C}$	$V_{IO}$	-	0.5	2.0	mV
Input Offset Voltage Temperature Coefficient $T_A = 0^\circ\text{C}$ to $105^\circ\text{C}$	$\Delta V_{IO}/\Delta T$	-	7.0	-	$\mu\text{V}/^\circ\text{C}$
Input Bias Current (Inverting input only) $T_A = 25^\circ\text{C}$ $T_A = 0^\circ\text{C}$ to $105^\circ\text{C}$	$I_{IB}$	-	-50	-150	nA
Large Signal Voltage Gain ( $V_{CC} = 15$ V, $R_L = 2.0$ k $\Omega$ , $V_{out} = 1.4$ V to 11.4 V) $T_A = 25^\circ\text{C}$ $T_A = 0^\circ\text{C}$ to $105^\circ\text{C}$	$A_{VOL}$	50	100	-	V/mV
Power Supply Rejection ( $V_{CC} = 5.0$ V to 30 V)	PSRR	40	90	-	dB
Output Source Current ( $V_{CC} = 15$ V, $V_{out} = 2.0$ V, $V_{ID} = +1.0$ V)	$I_{O+}$	10	16	-	mA
Output Sink Current ( $V_{CC} = 15$ V, $V_{out} = 2.0$ V, $V_{ID} = -1.0$ V)	$I_{O-}$	10	25	-	mA
Output Voltage Swing, High ( $V_{CC} = 30$ V, $R_L = 10$ k $\Omega$ , $V_{ID} = +1.0$ V) $T_A = 25^\circ\text{C}$ $T_A = 0^\circ\text{C}$ to $105^\circ\text{C}$	$V_{OH}$	27	28	-	V
Output Voltage Swing, Low ( $R_L = 10$ k $\Omega$ , $V_{ID} = -1.0$ V) $T_A = 25^\circ\text{C}$ $T_A = 0^\circ\text{C}$ to $105^\circ\text{C}$	$V_{OL}$	-	17	100	mV
Slew Rate ( $V_{in} = 0.5$ to 2.0 V, $V_{CC} = 15$ V, $R_L = 2.0$ k $\Omega$ , $A_v = 1.0$ , $C_L = 100$ pF)	SR	0.3	0.5	-	V/ $\mu\text{s}$
Unity Gain Bandwidth ( $V_{CC} = 30$ V, $R_L = 2.0$ k $\Omega$ , $C_L = 100$ pF, $V_{in} = 0.5$ Vpp @ $f = 70$ kHz)	BW	0.3	0.7	-	MHz
Total Harmonic Distortion ( $f = 1.0$ kHz, $A_v = 10$ , $R_L = 2.0$ k $\Omega$ , $V_{CC} = 30$ V, $V_{out} = 2.0$ Vpp)	THD	-	0.02	-	%

# NCP4300A

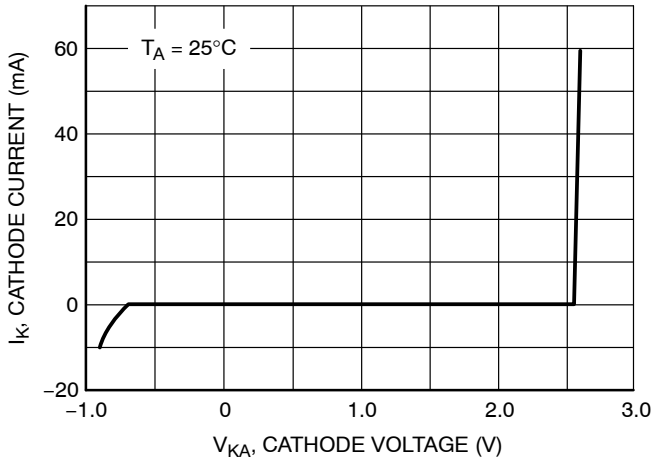
## TYPICAL ELECTRICAL CHARACTERISTICS (continued)

Characteristic	Symbol	Min	Typ	Max	Unit
<b>Op-Amp 2 (Independent op-amp)</b> ( $V_{CC} = 5.0\text{ V}$ , $V_{out} = 1.4\text{ V}$ , $T_A = 25^\circ\text{C}$ , unless otherwise noted)					
Input Offset Voltage $T_A = 25^\circ\text{C}$ $T_A = 0^\circ\text{C to } 105^\circ\text{C}$	$V_{IO}$	– –	0.5 –	2.0 3.0	mV
Input Offset Voltage Temperature Coefficient $T_A = 0^\circ\text{C to } 105^\circ\text{C}$	$\Delta V_{IO}/\Delta T$	–	7.0	–	$\mu\text{V}/^\circ\text{C}$
Input Offset Current $T_A = 25^\circ\text{C}$ $T_A = 0^\circ\text{C to } 105^\circ\text{C}$	$I_{IO}$	– –	2.0 –	30 30	nA
Input Bias Current $T_A = 25^\circ\text{C}$ $T_A = 0^\circ\text{C to } 105^\circ\text{C}$	$I_{IB}$	– –	–50 –	–150 –150	nA
Input Common Mode Voltage Range ( $V_{CC} = 0\text{ V to } 35\text{ V}$ )	$V_{ICR}$	–	0 to $V_{CC} - 1.5$	–	V
Large Signal Voltage Gain ( $V_{CC} = 15\text{ V}$ , $R_L = 2.0\text{ k}\Omega$ , $V_{out} = 1.4\text{ V to } 11.4\text{ V}$ ) $T_A = 25^\circ\text{C}$ $T_A = 0^\circ\text{C to } 105^\circ\text{C}$	$A_{VOL}$	50 25	100 –	– –	V/mV
Power Supply Rejection ( $V_{CC} = 5.0\text{ V to } 30\text{ V}$ )	PSRR	40	90	–	dB
Common Mode Rejection ( $V_{CM} = 0\text{ V to } 3.5\text{ V}$ ) $T_A = 25^\circ\text{C}$ $T_A = 0^\circ\text{C to } 105^\circ\text{C}$	CMRR	40 30	60 –	– –	dB
Output Source Current ( $V_{CC} = 15\text{ V}$ , $V_{out} = 2.0\text{ V}$ , $V_{ID} = +1.0\text{ V}$ )	$I_{O+}$	10	16	–	mA
Output Sink Current ( $V_{CC} = 15\text{ V}$ , $V_{out} = 2.0\text{ V}$ , $V_{ID} = -1.0\text{ V}$ )	$I_{O-}$	10	25	–	mA
Output Voltage Swing, High ( $V_{CC} = 30\text{ V}$ , $R_L = 10\text{ k}\Omega$ , $V_{ID} = +1.0\text{ V}$ ) $T_A = 25^\circ\text{C}$ $T_A = 0^\circ\text{C to } 105^\circ\text{C}$	$V_{OH}$	27 27	28 –	– –	V
Output Voltage Swing, Low ( $R_L = 10\text{ k}\Omega$ , $V_{ID} = -1.0\text{ V}$ ) $T_A = 25^\circ\text{C}$ $T_A = 0^\circ\text{C to } 105^\circ\text{C}$	$V_{OL}$	– –	17 –	100 100	mV
Slew Rate ( $V_{in} = 0.5\text{ to } 3.0\text{ V}$ , $V_{CC} = 15\text{ V}$ , $R_L = 2.0\text{ k}\Omega$ , $A_v = 1.0$ , $C_L = 100\text{ pF}$ )	SR	0.3	0.5	–	$\text{V}/\mu\text{s}$
Unity Gain Bandwidth ( $V_{CC} = 30\text{ V}$ , $R_L = 2.0\text{ k}\Omega$ , $C_L = 100\text{ pF}$ , $V_{in} = 0.5\text{ V}_{pp}$ @ $f = 70\text{ kHz}$ )	BW	0.3	0.7	–	MHz
Total Harmonic Distortion ( $f = 1.0\text{ KHz}$ , $A_v = 10$ , $R_L = 2.0\text{ k}\Omega$ , $V_{CC} = 30\text{ V}$ , $V_{out} = 2.0\text{ V}_{PP}$ )	THD	–	0.02	–	%

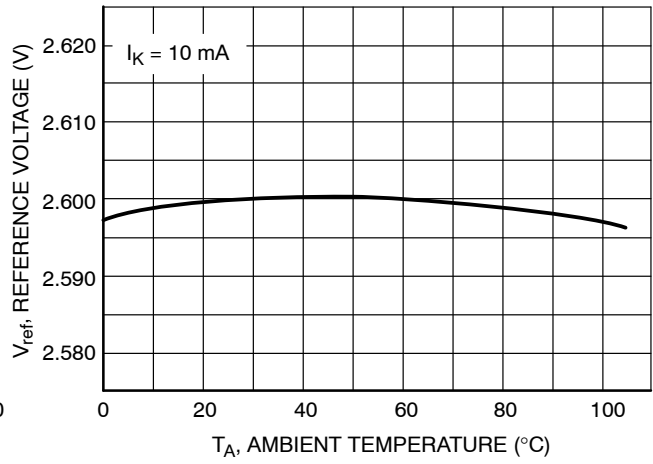
### Voltage Reference

Reference Voltage ( $I_K = 10\text{ mA}$ ) $T_A = 25^\circ\text{C}$ $T_A = 0^\circ\text{C to } 105^\circ\text{C}$	$V_{ref}$	– 2.574	2.60 2.60	– 2.626	V
Reference Input Voltage Deviation Over Full Temperature Range ( $I_K = 10\text{ mA}$ , $T_A = 0^\circ\text{C to } 105^\circ\text{C}$ )	$\Delta V_{ref}$	–	5.0	22	mV
Minimum Cathode Current for Regulation	$I_{K(min)}$	–	55	80	$\mu\text{A}$
Dynamic Impedance $T_A = 25^\circ\text{C}$ , $I_K = 1.0\text{ to } 80\text{ mA}$ , $f < 1.0\text{ KHz}$ $T_A = 0^\circ\text{C to } 125^\circ\text{C}$ , $I_K = 1.0\text{ mA to } 60\text{ mA}$ , $f < 1.0\text{ KHz}$	$ Z_{KA} $	– –	0.3 –	0.5 0.6	$\Omega$

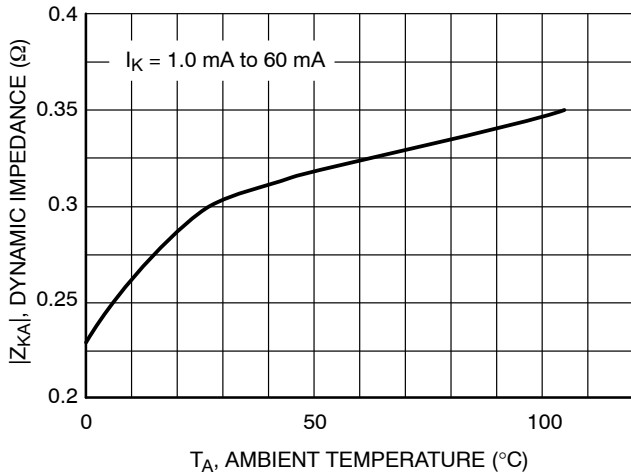
# NCP4300A



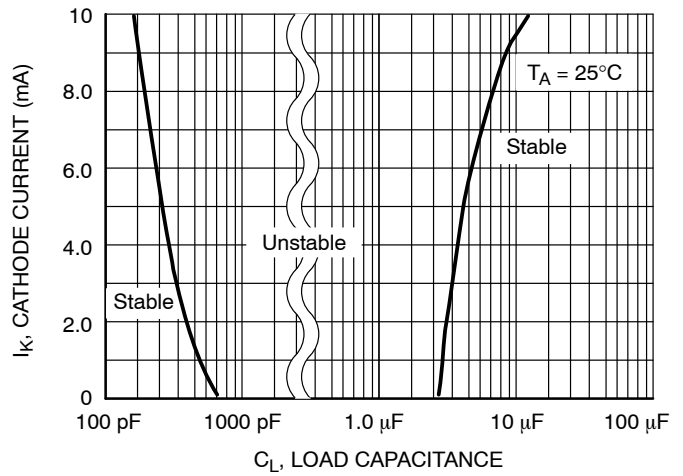
**Figure 2. Reference Cathode Current vs. Cathode Voltage**



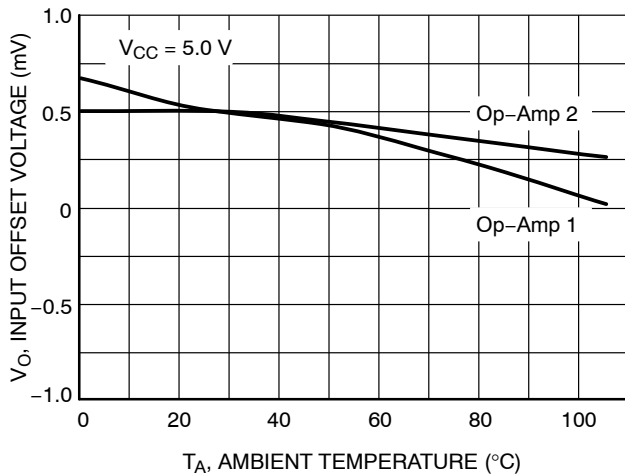
**Figure 3. Reference Voltage vs. Ambient Temperature**



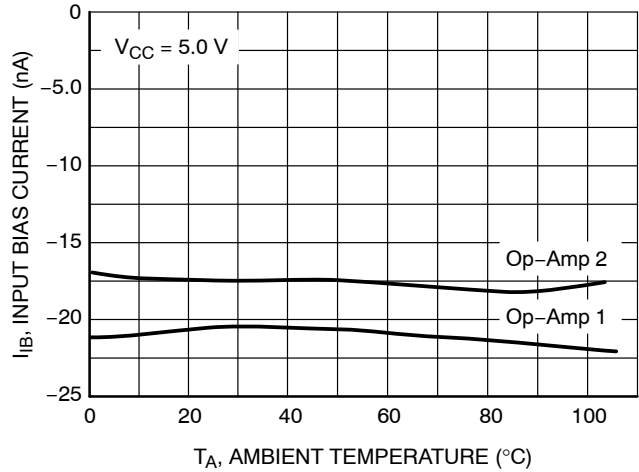
**Figure 4. Reference Dynamic Impedance vs. Ambient Temperature**



**Figure 5. Reference Stability vs. Load Capacitance**

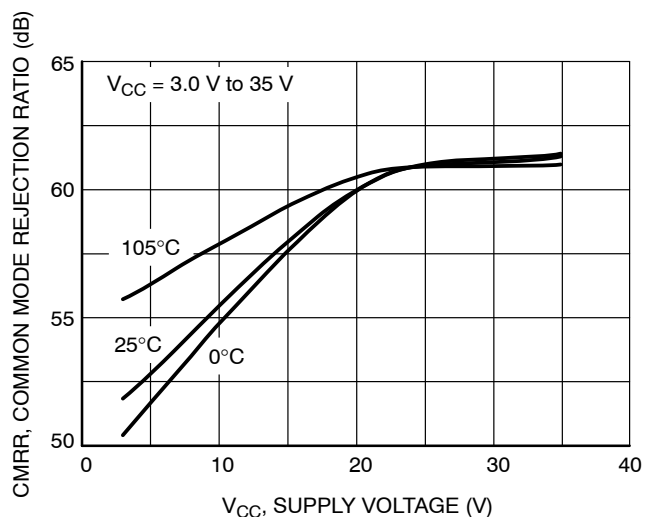


**Figure 6. Input Offset Voltage vs. Ambient Temperature**



**Figure 7. Input Bias Current vs. Ambient Temperature**

# NCP4300A



**Figure 8. Common Mode Rejection Ratio vs. Supply Voltage**

## DETAILED OPERATING DESCRIPTION

### INTRODUCTION

Power supplies and battery chargers require precise control of output voltage and current in order to prevent catastrophic damage to the system connected. Many present day power sources contain a wide assortment of building blocks and glue devices to perform the required sensing for proper regulation. Typical feedback loop circuits may consist of a voltage and current amplifier, summing circuitry and a reference. The NCP4300A contains all of these basic functions in a manner that is easily adaptable to many of the various power source-load configurations.

### OPERATING DESCRIPTION

The NCP4300A is an analog regulation control circuit that is designed to simultaneously close the voltage and current feedback loops in power supply and battery charger applications. This device can control the feedback loop in either constant-voltage (CV) or constant-current (CC) mode with smooth crossover. A concise description of the integrated circuit blocks is given in below. The functional block diagram of the IC is shown in Figure 1.

#### Internal Reference

An internal precision band gap reference is used to set the 2.6 V voltage threshold and current threshold setting. The

reference is initially trimmed to a  $\pm 0.5\%$  tolerance at  $T_A = 25^\circ\text{C}$  and is guaranteed to be within  $\pm 1.0\%$  over an ambient temperature range of  $0^\circ\text{C}$  to  $105^\circ\text{C}$ .

#### Voltage Sensing Operational Amplifier (Op-Amp 1)

The internal Op-Amp 1 is designed to perform the voltage control function. The non-inverting input of the op-amp is connected to the precision voltage reference internally. The inverting input of the op-amp monitors the voltage information derived from the system output. As the control threshold is internally connected to the voltage reference, the voltage regulation threshold is fixed at 2.6 V. For any output voltage from 2.6 V up to the maximum limit can be configured with an external resistor divider. The output terminal of Op-Amp 1 (pin 1) provides the error signal for output voltage control. The output pin also provides a means for external compensation.

#### Independent Operational Amplifier (Op-Amp 2)

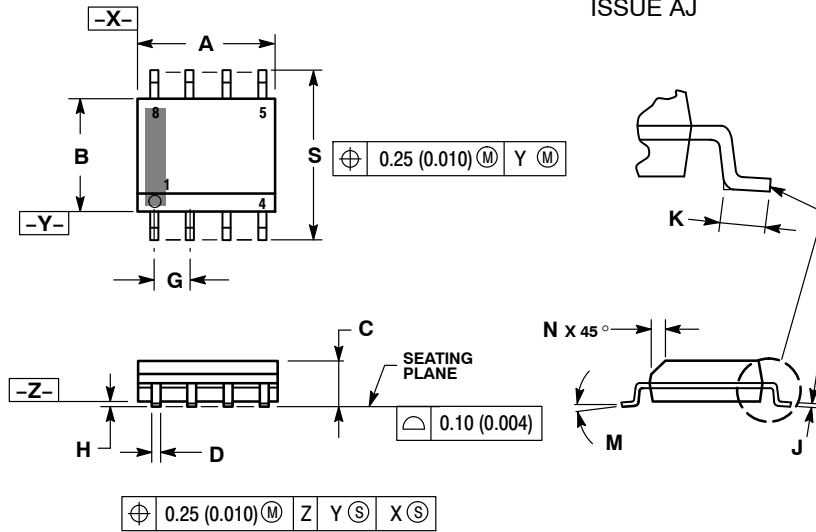
The internal Op-Amp 2 is configured as a general purpose op-amp with all terminals available for the user. With the low offset voltage provided, 0.5 mV, this op-amp can be used for current sensing in a constant current regulator.



# NCP4300A

## PACKAGE DIMENSIONS

### SOIC-8 D SUFFIX CASE 751-07 ISSUE AJ

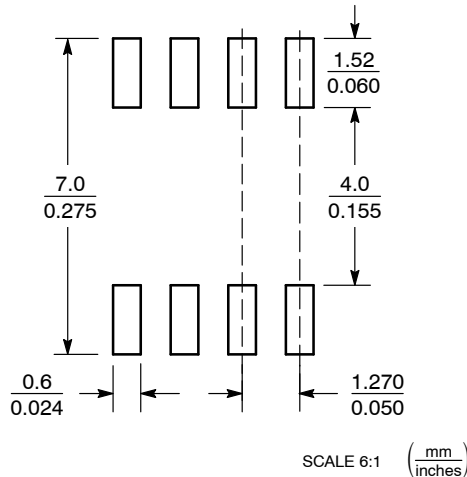


#### NOTES:

1. DIMENSIONING AND TOLERANCING PER ANSI Y14.5M, 1982.
2. CONTROLLING DIMENSION: MILLIMETER.
3. DIMENSION A AND B DO NOT INCLUDE MOLD PROTRUSION.
4. MAXIMUM MOLD PROTRUSION 0.15 (0.006) PER SIDE.
5. DIMENSION D DOES NOT INCLUDE DAMBAR PROTRUSION. ALLOWABLE DAMBAR PROTRUSION SHALL BE 0.127 (0.005) TOTAL IN EXCESS OF THE D DIMENSION AT MAXIMUM MATERIAL CONDITION.
6. 751-01 THRU 751-06 ARE OBSOLETE. NEW STANDARD IS 751-07.

DIM	MILLIMETERS		INCHES	
	MIN	MAX	MIN	MAX
A	4.80	5.00	0.189	0.197
B	3.80	4.00	0.150	0.157
C	1.35	1.75	0.053	0.069
D	0.33	0.51	0.013	0.020
G	1.27 BSC		0.050 BSC	
H	0.10	0.25	0.004	0.010
J	0.19	0.25	0.007	0.010
K	0.40	1.27	0.016	0.050
M	0°	8°	0°	8°
N	0.25	0.50	0.010	0.020
S	5.80	6.20	0.228	0.244

### SOLDERING FOOTPRINT\*



\*For additional information on our Pb-Free strategy and soldering details, please download the ON Semiconductor Soldering and Mounting Techniques Reference Manual, SOLDERRM/D.

ON Semiconductor and are registered trademarks of Semiconductor Components Industries, LLC (SCILLC). SCILLC reserves the right to make changes without further notice to any products herein. SCILLC makes no warranty, representation or guarantee regarding the suitability of its products for any particular purpose, nor does SCILLC assume any liability arising out of the application or use of any product or circuit, and specifically disclaims any and all liability, including without limitation special, consequential or incidental damages. "Typical" parameters which may be provided in SCILLC data sheets and/or specifications can and do vary in different applications and actual performance may vary over time. All operating parameters, including "Typicals" must be validated for each customer application by customer's technical experts. SCILLC does not convey any license under its patent rights nor the rights of others. SCILLC products are not designed, intended, or authorized for use as components in systems intended for surgical implant into the body, or other applications intended to support or sustain life, or for any other application in which the failure of the SCILLC product could create a situation where personal injury or death may occur. Should Buyer purchase or use SCILLC products for any such unintended or unauthorized application, Buyer shall indemnify and hold SCILLC and its officers, employees, subsidiaries, affiliates, and distributors harmless against all claims, costs, damages, and expenses, and reasonable attorney fees arising out of, directly or indirectly, any claim of personal injury or death associated with such unintended or unauthorized use, even if such claim alleges that SCILLC was negligent regarding the design or manufacture of the part. SCILLC is an Equal Opportunity/Affirmative Action Employer. This literature is subject to all applicable copyright laws and is not for resale in any manner.

### PUBLICATION ORDERING INFORMATION

**LITERATURE FULFILLMENT:**  
Literature Distribution Center for ON Semiconductor  
P.O. Box 5163, Denver, Colorado 80217 USA  
**Phone:** 303-675-2175 or 800-344-3860 Toll Free USA/Canada  
**Fax:** 303-675-2176 or 800-344-3867 Toll Free USA/Canada  
**Email:** orderlit@onsemi.com

**N. American Technical Support:** 800-282-9855 Toll Free USA/Canada  
**Europe, Middle East and Africa Technical Support:**  
Phone: 421 33 790 2910  
**Japan Customer Focus Center**  
Phone: 81-3-5773-3850

**ON Semiconductor Website:** [www.onsemi.com](http://www.onsemi.com)

**Order Literature:** <http://www.onsemi.com/orderlit>

For additional information, please contact your local Sales Representative

## Looking for pricing, stock, or lifecycle information?

Click below to explore more details on WIN SOURCE:

 [View NCP4300AD](#) on WIN SOURCE

 [ON Semiconductor](#) Information

## Optimize Your Supply Chain with WIN SOURCE Solutions

-  Global Sourcing Solution
-  Obsolete Management
-  Cost Control Management
-  Shortage Management
-  Alternative Solution
-  Excess Inventory Management