



THE DATASHEET OF
4108



SURFACE MOUNT AUDIO JACKS

- Mates with 2.5mm and 3.5mm plugs
- Designed for reliable interface with audio equipment including computer speakers, headphones, sound cards, cell phones, etc.
- Models available for mono and stereo applications
- Low profile, surface mount design

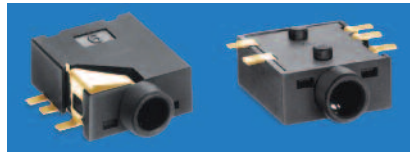

SPECIFICATIONS

Housing: Polyamide, UL Rated 94V-0
Ground Terminal: .012 (.30) Brass, Gold Flash ①
Spring Contacts: .008 (.20) Phosphor Bronze, Gold Flash ② ⑤
Shunt Terminals: .012 (.30) Brass, Gold flash ③ ④

FOR 2.5 mm PLUGS

SUPPLIED ON TAPE AND REEL

FOR 3.5 mm PLUGS

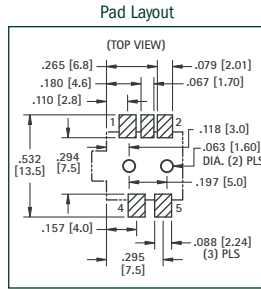
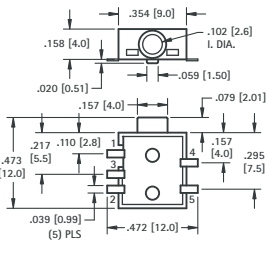

STEREO SCHEMATIC

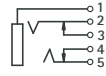

MONO SCHEMATIC

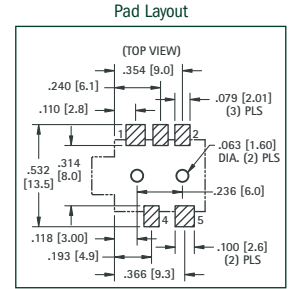
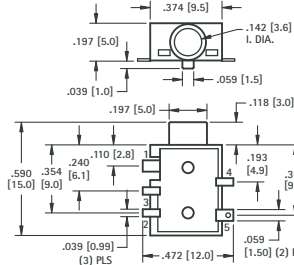
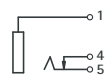

CAT. NO. 980TR (Stereo)

CAT. NO. 982TR (Mono)

Tape Spec's: 24mm wide; 16mm pitch
Reel Spec's: 15 inch reel (1,000 pieces per reel)

CAT. NO. 981TR (Stereo)

CAT. NO. 983TR (Mono)

Tape Spec's: 24mm wide; 16mm pitch
Reel Spec's: 15 inch reel (800 pieces per reel)

BINDING POSTS

All Keystone binding posts are designed to prevent accidental contact with current carrying parts. They feature a "limited opening" captivated head to insure safety. Ideal for audio circuitry, R.F. circuitry, oscilloscopes, power supplies and various other applications.

These multi-purpose binding posts feature high current rating, captivated heads and anti-rotation stud mounting.

Note: Binding Posts accept .175" (4.5) Banana Plugs, .080" (2.08) Tip Plugs, Spade Lugs, Alligator Clips, Wires and EZ hooks.

STANDARD BINDING POST

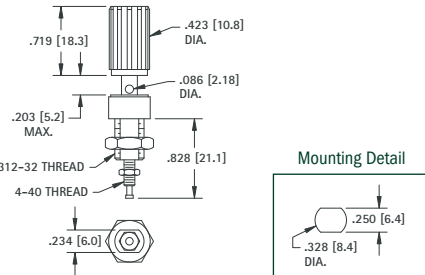

For panels up to .281 (7.1) thick

CAT. NO.	COLOR
7004	RED
7005	BLACK

MATERIAL:

Stud: Brass per QQ-B-626
Plating: Silver Plate
Insulation: Nylon
Current Rating: 15 Amps
Stud to Panel Capacitance: 3.3 pF Nominal

UNINSULATED BINDING POST

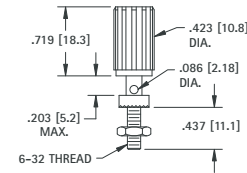

For panels up to .313 (8.0) thick

CAT. NO.	COLOR
7006	RED
7007	BLACK

MATERIAL:

Stud: Brass per QQ-B-626
Plating: Nickel Plate
Insulation: Nylon
Current Rating: 15 Amps, 1000V AC Working

STANDARD DUAL HEX HEAD

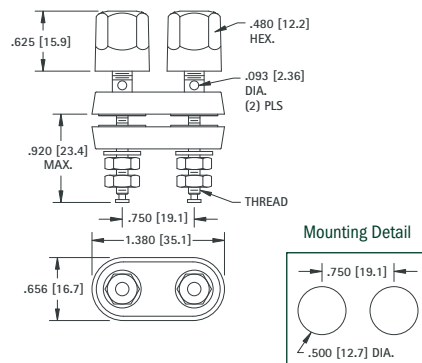

GOLD PLATE		NICKEL PLATE	
CAT. NO.	THREAD	CAT. NO.	THREAD
4108	8-32	7018	8-32
4109	10-32	7019	10-32

MATERIAL:

Stud: Brass per ASTM B-16.
Insulation: Nylon
Current Rating: 30 Amps, 1000V AC Working

STANDARD HEX HEAD

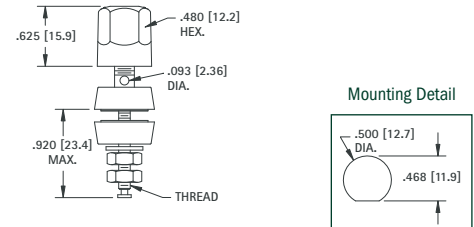



GOLD PLATE			NICKEL PLATE		
CAT. NO.	THREAD	COLOR	CAT. NO.	THREAD	COLOR
4096	8-32	RED	4091	8-32	RED
4097	8-32	BLACK	4092	8-32	BLACK
7016	10-32	RED	4093	10-32	RED
7017	10-32	BLACK	4094	10-32	BLACK
7023	10-32	WHITE	4198	10-32	WHITE
7024	10-32	YELLOW	4199	10-32	YELLOW

MATERIAL:

Stud: Brass per ASTM B-16.
Insulation: Nylon
Current Rating: 30 Amps, 1000V AC Working

Looking for pricing, stock, or lifecycle information?

Click below to explore more details on WIN SOURCE:

-  [View 4108 on WIN SOURCE](#)
-  [Keystone Electronics](#) Information

Optimize Your Supply Chain with WIN SOURCE Solutions

-  Global Sourcing Solution
-  Obsolete Management
-  Cost Control Management
-  Shortage Management
-  Alternative Solution
-  Excess Inventory Management