



**THE DATASHEET OF
MABA-011032**



MABA-011032



**Transformer, 1:3
40 MHz - 1000MHz**

Rev. V2

Features

- 1:3 impedance ratio
- Surface mount
- Available on tape and reel
- 260°C reflow compatible
- RoHS Compliant and Pb free
- Excellent temperature stability
- Can be used on 50Ω and 75Ω systems

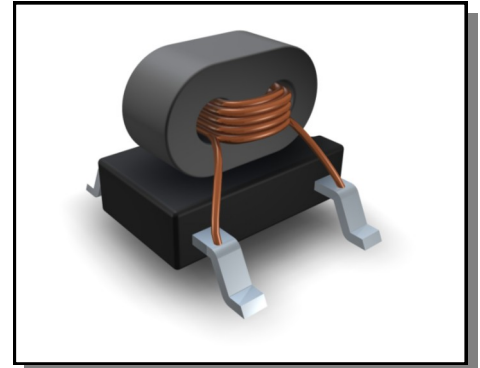

Electrical Specifications: $Z_0 = 75\Omega$, $T_A = 25^\circ\text{C}$, $P_{in} = 0\text{dBm}$

Parameter	Conditions	Units	Min	Typ	Max
Frequency Range		MHz	40		1000
Impedance		Ω		75	
Impedance Ratio				1:3	
Insertion Loss1 (Pin4 to Pin3)	40 - 500 MHz	dB	-	1.0	1.7
	500 - 1000 MHz	dB	-	1.2	2.5
Insertion Loss2 (Pin4 to Pin1)	40 - 500 MHz	dB	-	1.5	2.0
	500 - 1000 MHz	dB	-	2.0	3.2
Amplitude Unbalance	40 - 500 MHz	dB	-	0.5	± 1.3
	500 - 1000 MHz	dB	-	0.8	± 1.7
Phase Balance	40 - 500 MHz	$^\circ$	-	11	± 21
	500 - 1000 MHz	$^\circ$	-	22	± 32
Input Return Loss	40 - 500 MHz	dB	13	17	-
	500 - 1000 MHz	dB	11	13	-

Pin Configuration

Pin No.	Function
1	Output 2
2	Centre tap
3	Output 1
4	Input
6	Ground

Schematic

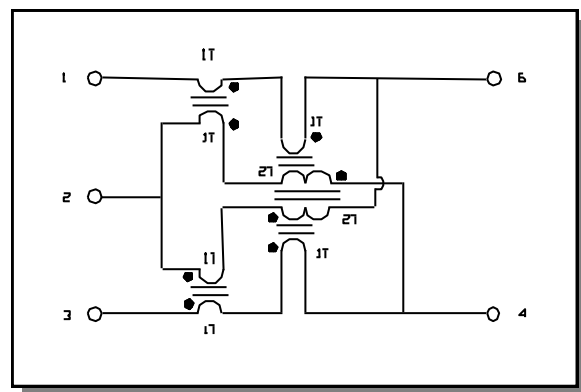

MA-COM Technology Solutions Inc. (MACOM) and its affiliates reserve the right to make changes to the product(s) or information contained herein without notice. Visit www.macom.com for additional data sheets and product information.

For further information and support please visit:
<https://www.macom.com/support>

Insertion Loss: Pin4—Pin3

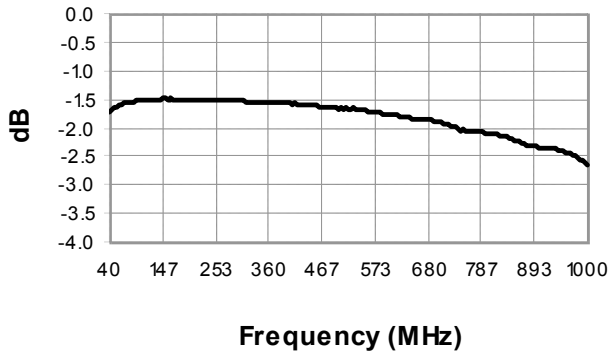

Insertion Loss: Pin4—Pin1

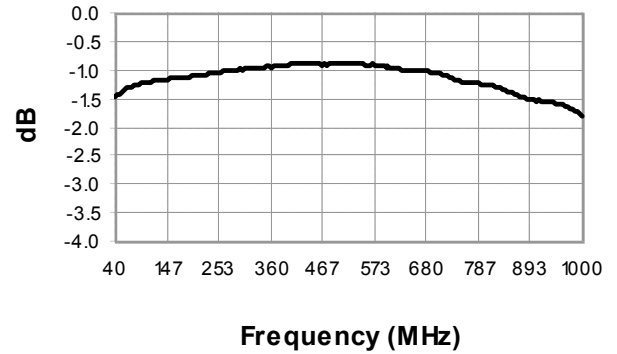

Amplitude Balance

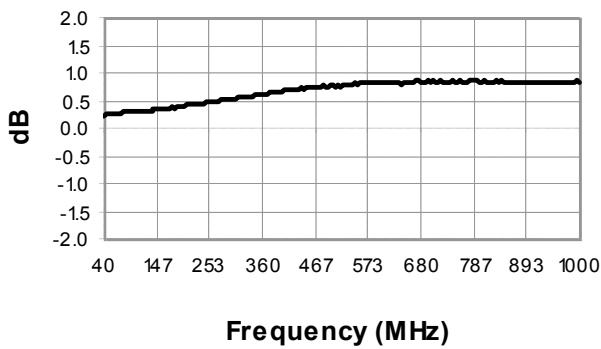

Phase Balance

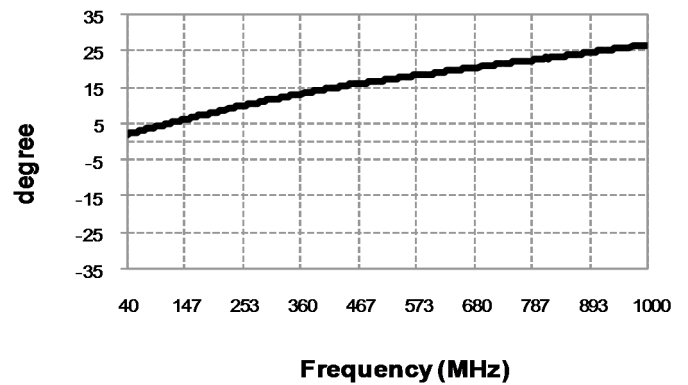

Return Loss: Input

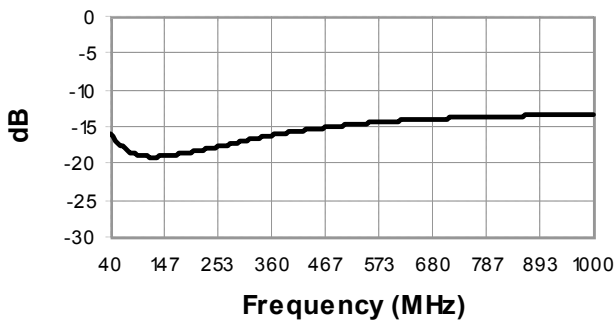

Transformer, 1:3
40 MHz - 1000MHz

Rev. V2

Outline Drawing

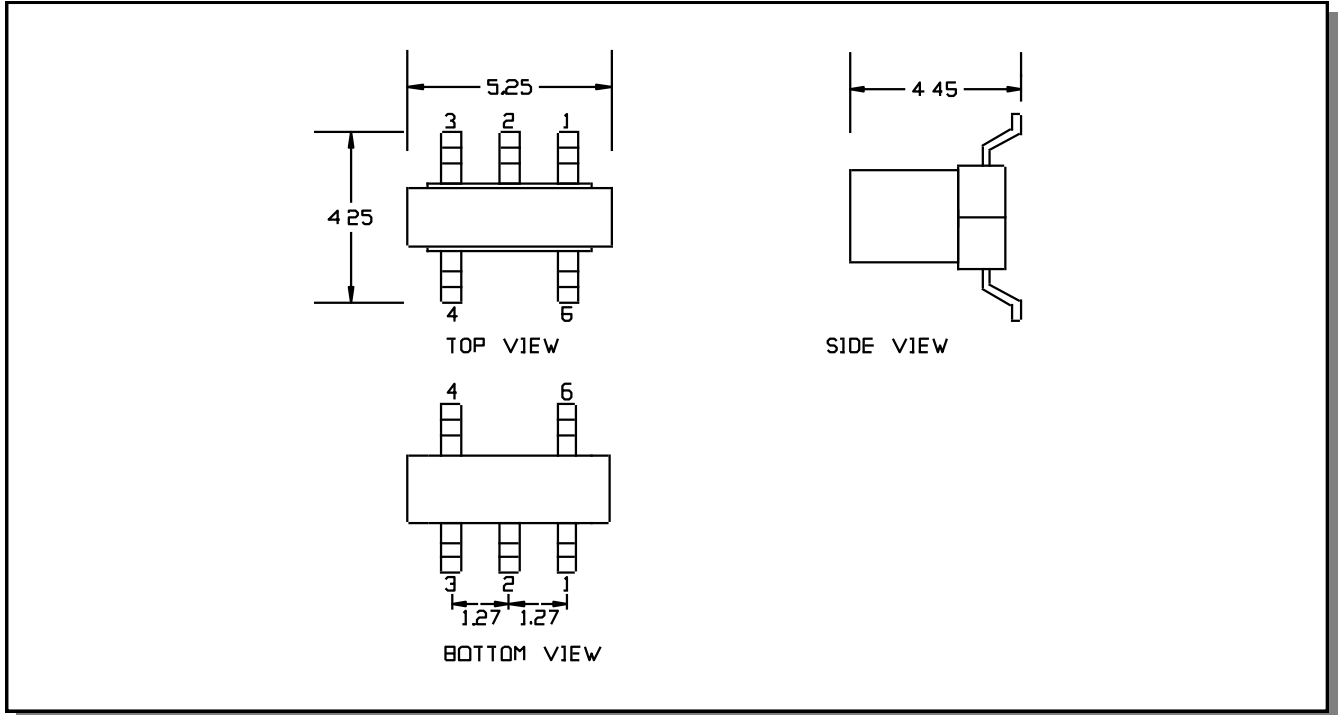

1. Dimensions in mm.
2. Tolerance: ± 0.2 mm unless otherwise noted.
3. Model number and lot code are printed on the reel.
4. Finish: CuSn6

Application Circuit

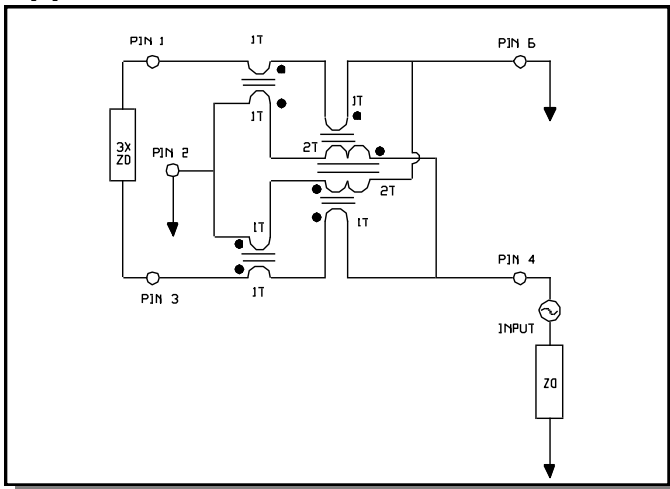

Recommended Footprint

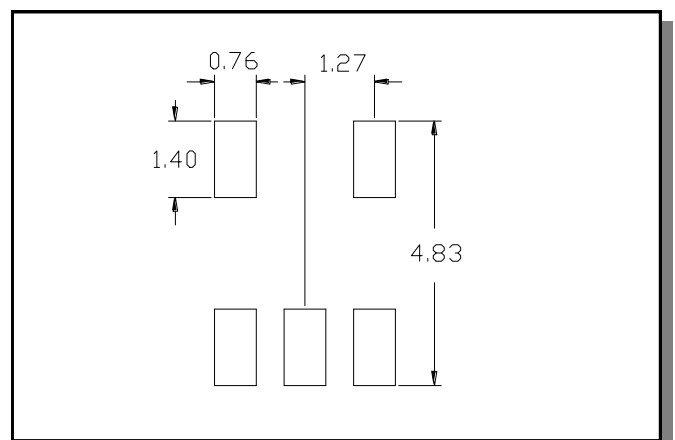

Tape & Reel Information

Parameter	Units	Value
Qty per reel	-	2000
Reel size	mm	330
Tape width	mm	12.00
Pitch	mm	8.00
A ₀	mm	4.50
B ₀	mm	5.40
K ₀	mm	4.70
Orientation	-	F28

Ordering Information

Part Number	Description
MABA-011032	Tape & Reel

Recommended Maximum Ratings

Parameter	Units	Min	Max
Input Power	mW		250
DC Current	mA		200
Operating Temperature Range	°C	-40	+85

Temperature data available on request

M/A-COM Technology Solutions Inc. All rights reserved.

Information in this document is provided in connection with M/A-COM Technology Solutions Inc ("MACOM") products. These materials are provided by MACOM as a service to its customers and may be used for informational purposes only. Except as provided in MACOM's Terms and Conditions of Sale for such products or in any separate agreement related to this document, MACOM assumes no liability whatsoever. MACOM assumes no responsibility for errors or omissions in these materials. MACOM may make changes to specifications and product descriptions at any time, without notice. MACOM makes no commitment to update the information and shall have no responsibility whatsoever for conflicts or incompatibilities arising from future changes to its specifications and product descriptions. No license, express or implied, by estoppels or otherwise, to any intellectual property rights is granted by this document.

THESE MATERIALS ARE PROVIDED "AS IS" WITHOUT WARRANTY OF ANY KIND, EITHER EXPRESS OR IMPLIED, RELATING TO SALE AND/OR USE OF MACOM PRODUCTS INCLUDING LIABILITY OR WARRANTIES RELATING TO FITNESS FOR A PARTICULAR PURPOSE, CONSEQUENTIAL OR INCIDENTAL DAMAGES, MERCHANTABILITY, OR INFRINGEMENT OF ANY PATENT, COPYRIGHT OR OTHER INTELLECTUAL PROPERTY RIGHT. MACOM FURTHER DOES NOT WARRANT THE ACCURACY OR COMPLETENESS OF THE INFORMATION, TEXT, GRAPHICS OR OTHER ITEMS CONTAINED WITHIN THESE MATERIALS. MACOM SHALL NOT BE LIABLE FOR ANY SPECIAL, INDIRECT, INCIDENTAL, OR CONSEQUENTIAL DAMAGES, INCLUDING WITHOUT LIMITATION, LOST REVENUES OR LOST PROFITS, WHICH MAY RESULT FROM THE USE OF THESE MATERIALS.

MACOM products are not intended for use in medical, lifesaving or life sustaining applications. MACOM customers using or selling MACOM products for use in such applications do so at their own risk and agree to fully indemnify MACOM for any damages resulting from such improper use or sale.

5

M/A-COM Technology Solutions Inc. (MACOM) and its affiliates reserve the right to make changes to the product(s) or information contained herein without notice.
Visit www.macom.com for additional data sheets and product information.

Looking for pricing, stock, or lifecycle information?

Click below to explore more details on WIN SOURCE:

- ⊖ [View MABA-011032 on WIN SOURCE](#)
- ⊖ [M/A-Com Technology Solutions](#) Information

Optimize Your Supply Chain with WIN SOURCE Solutions

- ✓ Global Sourcing Solution
- ✓ Obsolete Management
- ✓ Cost Control Management
- ✓ Shortage Management
- ✓ Alternative Solution
- ✓ Excess Inventory Management