



**THE DATASHEET OF  
BA10358N**



# Dual ground sense operational amplifier

## BA10358 / BA10358F / BA10358FV / BA10358N

The BA10358, BA10358F, BA10358FV, and BA10358N are monolithic ICs with two independent built-in operational amplifiers featuring high gain and frequency compensation.

These products offer a particularly wide range of operating voltages, from 3 to 32V (when using a single power supply). Current dissipation is low and remains constant regardless of the power supply voltage. Available packages include an 8-pin DIP (BA10358), an 8-pin SOP (BA10358F), an 8-pin SSOP-B (BA10358FV), and an 8-pin SIP (BA10358N).

### ●Features

- 1) Can be driven with a single power supply.
- 2) Extremely low current dissipation.
- 3) Level is compatible with any kind of logic circuit.
- 4) Operating voltage range is 3 to 32V for single power supply,  $\pm 1.5$  to  $\pm 16$ V for dual power supply.
- 5) High DC voltage gain.
- 6) Wide frequency response.
- 7) Pin assignments is the same as the general-purpose 4558 model.
- 8) Compatible with model 358 operation amplifiers of other manufacturers.

### ●Absolute maximum ratings

Parameter	Symbol	Limits				Unit
		BA10358	BA10358F	BA10358FV	BA10358N	
Power supply voltage	$V_{CC}$	32 ( $\pm 16$ )	32 ( $\pm 16$ )	32 ( $\pm 16$ )	32 ( $\pm 16$ )	V
Power dissipation	$P_d$	800*	550*	350*	900*	mW
Differential input voltage	$V_{ID}$	$\pm V_{CC}$	$\pm V_{CC}$	$\pm V_{CC}$	$\pm V_{CC}$	V
Common-mode input voltage	$V_I$	$-0.3 \sim V_{CC}$	$-0.3 \sim V_{CC}$	$-0.3 \sim V_{CC}$	$-0.3 \sim V_{CC}$	V
Operating temperature	$T_{opr}$	$-40 \sim +85$	$-40 \sim +85$	$-40 \sim +85$	$-40 \sim +85$	$^{\circ}\text{C}$
Storage temperature	$T_{stg}$	$-55 \sim +125$	$-55 \sim +125$	$-55 \sim +125$	$-55 \sim +125$	$^{\circ}\text{C}$

\* Refer to the  $P_d$  characteristic diagram.

The values for the BA10358F are those when it is mounted on a glass epoxy board (50mm  $\times$  50mm  $\times$  1.6mm).

The values for the BA10358FV are those when it is mounted on a glass epoxy board (70mm  $\times$  70mm  $\times$  1.6mm).

●Block diagram

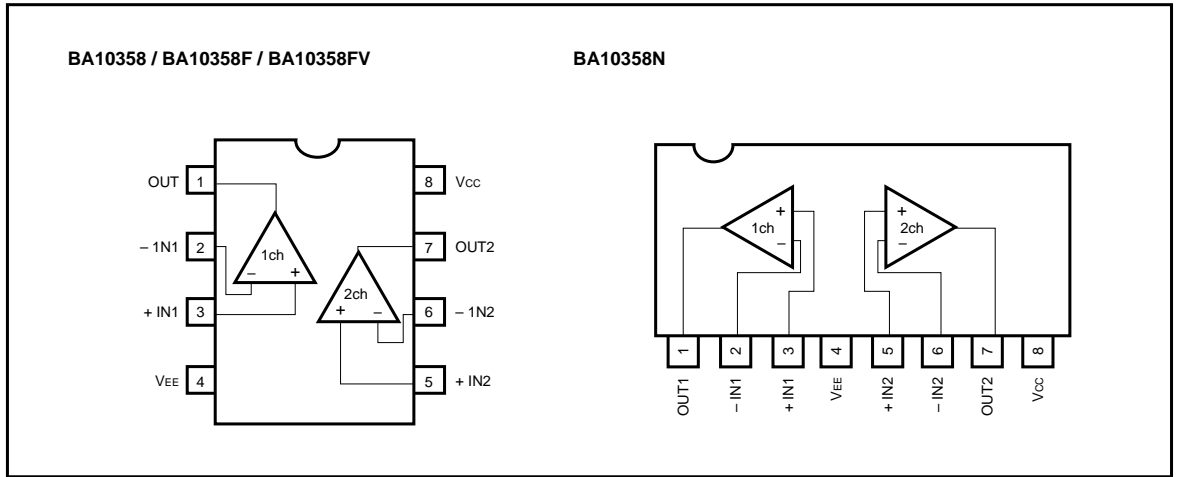

●Internal circuit configuration (diagram shows only one channel)

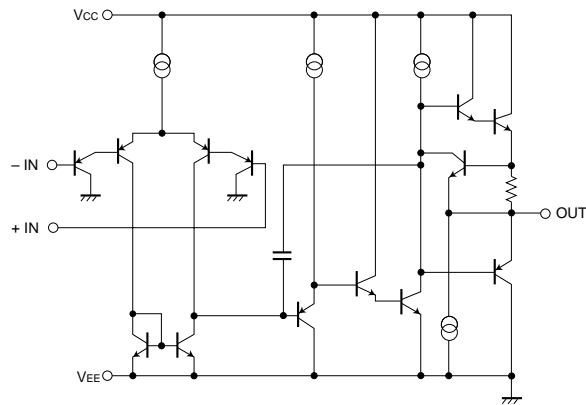

●Electrical characteristics (unless otherwise noted,  $T_a = 25^\circ\text{C}$ ,  $V_{CC} = +5\text{ V}$ )

Parameter		Symbol	Min.	Typ.	Max.	Unit	Conditions
Input offset voltage		$V_{IO}$	—	2	7	mV	$R_s = 50\Omega$
Input offset current		$I_{IO}$	—	5	50	nA	—
Input bias current		$I_B$	—	45	250	nA	—
High-amplitude voltage gain		$A_v$	25	100	—	V / mV	$R_L \geq 2k\Omega$ , $V_{CC} = 15\text{V}$
Common-mode input voltage		$V_{ICM}$	0	—	$V_{CC} - 1.5$	V	—
Output voltage		$V_O$	0	—	$V_{CC} - 1.5$	V	$R_L = 2k\Omega$
Common-mode rejection ratio		CMRR	65	80	—	dB	—
Power supply voltage rejection ratio		PSRR	65	100	—	dB	$R_s = 50\Omega$
Quiescent current		$I_Q$	—	0.7	1.2	mA	$R_L = \infty$ , on All Op - Amps
Channel separation		CS	—	120	—	dB	$f = 1\text{ kHz}$ input conversion
Maximum output current	source	$I_{source}$	10	20	—	mA	$V_{IN}^+ = 1\text{V}$ , $V_{IN}^- = 0\text{V}$ , $V_O = 0\text{V}$
	sink	$I_{sink}$	10	20	—	mA	$V_{IN}^- = 1\text{V}$ , $V_{IN}^+ = 0\text{V}$ , $V_O = V_{CC}$

●Electrical characteristic curves

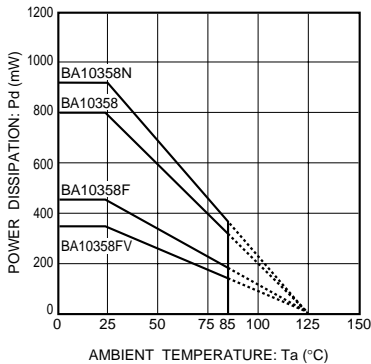

Fig. 1 Power dissipation vs. ambient temperature

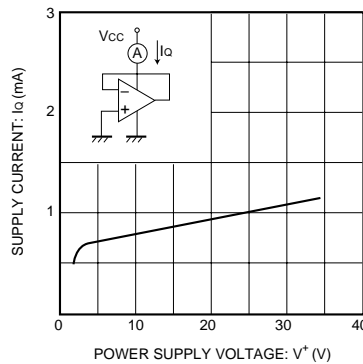

Fig. 2 Quiescent current vs. power supply voltage

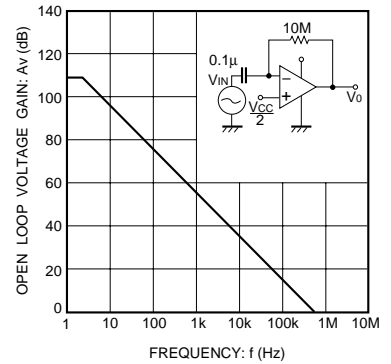

Fig. 3 Open loop voltage gain vs. frequency

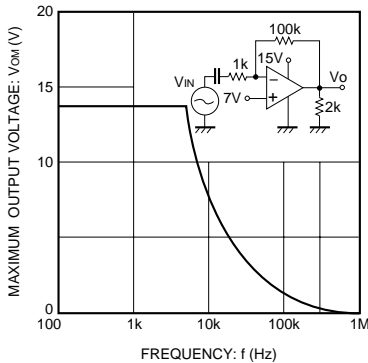

Fig. 4 Maximum output voltage vs. frequency

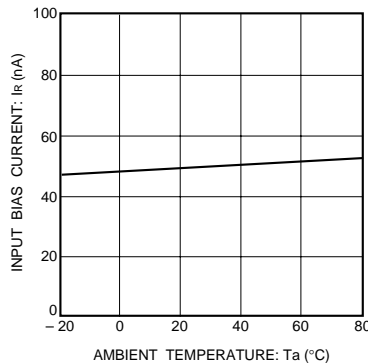

Fig. 5 Input bias current vs. ambient temperature

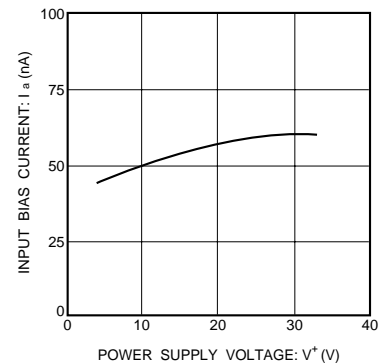

Fig. 6 Input bias current vs. power supply voltage

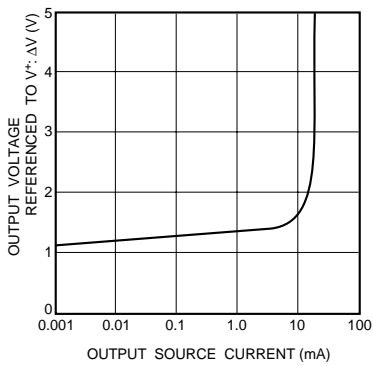

Fig. 7 Voltage difference during power supply output vs. output source current

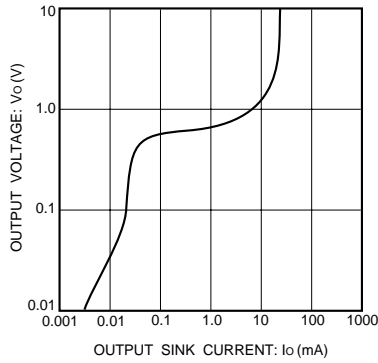

Fig. 8 Output voltage vs. output sink current

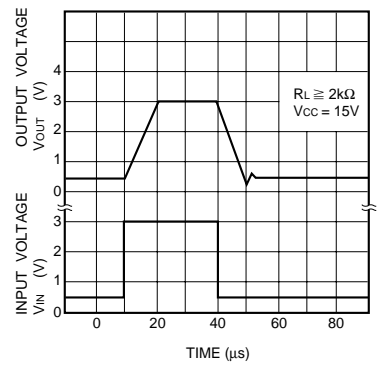

Fig. 9 Output response characteristics

● Operation notes

(1) Handling unused circuits

If there are any circuits which are not being used, we recommend making connections as shown in Figure 10, with the non-inverted input pin connected to the potential within the in-phase input voltage range ( $V_{ICM}$ ).

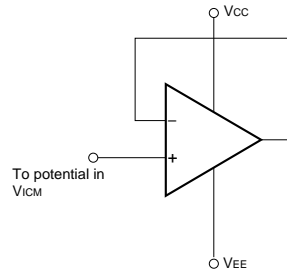
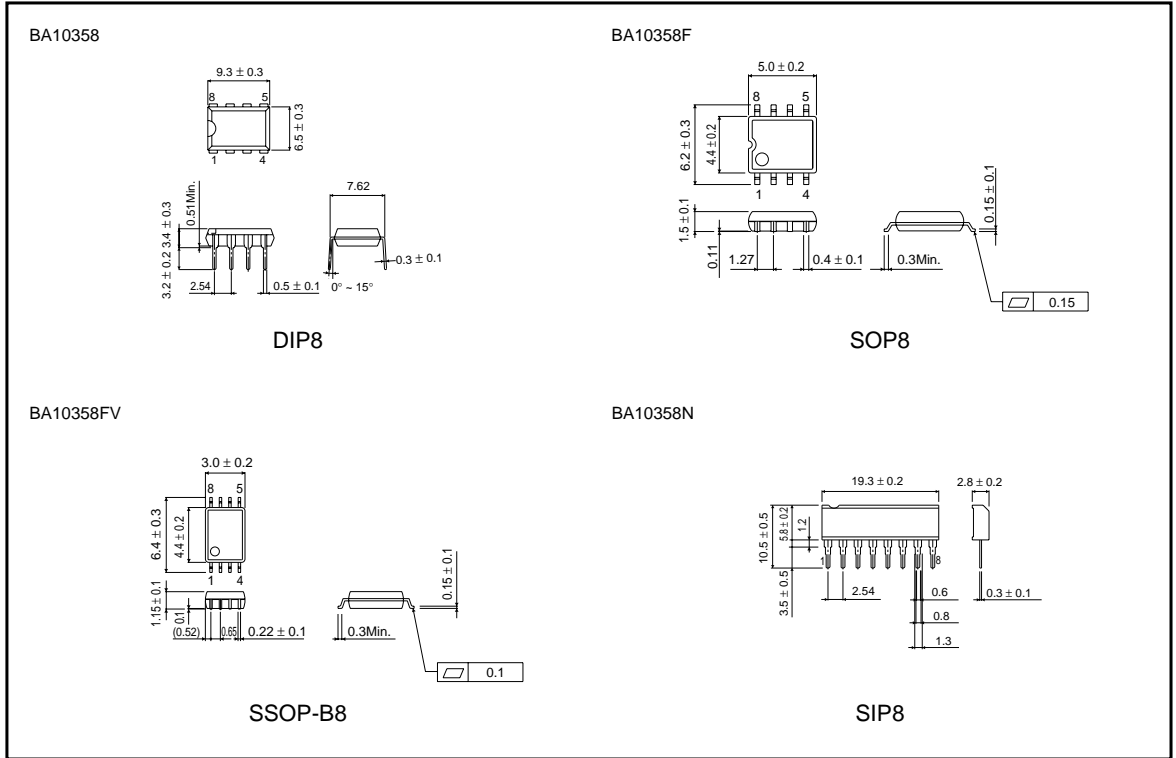



Fig. 10 Handling unused circuits

● External dimensions (Units: mm)



## Looking for pricing, stock, or lifecycle information?

Click below to explore more details on WIN SOURCE:

-  [View BA10358N on WIN SOURCE](#)
-  [Rohm Semiconductor Information](#)

## Optimize Your Supply Chain with WIN SOURCE Solutions

-  Global Sourcing Solution
-  Obsolete Management
-  Cost Control Management
-  Shortage Management
-  Alternative Solution
-  Excess Inventory Management