



THE DATASHEET OF SN74CBT16212ADLR



SN54CBT16212A, SN74CBT16212A 24-BIT FET BUS-EXCHANGE SWITCHES

SCDS007U – NOVEMBER 1992 – REVISED JUNE 2005

- Members of the Texas Instruments Widebus™ Family
- 5-Ω Switch Connection Between Two Ports
- TTL-Compatible Input Levels
- Latch-Up Performance Exceeds 250 mA Per JESD 17
- ESD Protection Exceeds JESD 22 – 200-V Machine Model (A115-A)

SN54CBT16212A . . . WD PACKAGE
SN74CBT16212A . . . DGG, DGV, OR DL PACKAGE
(TOP VIEW)

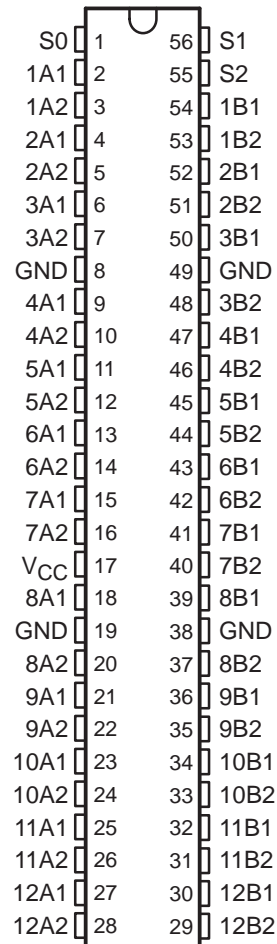

description/ordering information

The 'CBT16212A devices provide 24 bits of high-speed TTL-compatible bus switching or exchanging. The low on-state resistance of the switch allows connections to be made with minimal propagation delay.

Each device operates as a 24-bit bus switch or a 12-bit bus exchanger that provides data exchanging between the four signal ports via the data-select (S0, S1, S2) terminals.

ORDERING INFORMATION

T _A	PACKAGE†		ORDERABLE PART NUMBER	TOP-SIDE MARKING
-40°C to 85°C	SSOP – DL	Tube	SN74CBT16212ADL	CBT16212A
		Tape and reel	SN74CBT16212ADLR	
	TSSOP – DGG	Tape and reel	SN74CBT16212ADGGR	CBT16212A
	TVSOP – DGV	Tape and reel	SN74CBT16212ADGVR	CY212A
	VFBGA – GQL	Tape and reel	SN74CBT16212AGQLR	CY212A
VFBGA – ZQL (Pb-free)	SN74CBT16212AZQLR			
-55°C to 125°C	CFP – WD	Tube	SNJ54CBT16212AWD	SNJ54CBT16212AWD

† Package drawings, standard packing quantities, thermal data, symbolization, and PCB design guidelines are available at www.ti.com/sc/package.



Please be aware that an important notice concerning availability, standard warranty, and use in critical applications of Texas Instruments semiconductor products and disclaimers thereto appears at the end of this data sheet.

Widebus is a trademark of Texas Instruments.

PRODUCTION DATA information is current as of publication date. Products conform to specifications per the terms of Texas Instruments standard warranty. Production processing does not necessarily include testing of all parameters.



POST OFFICE BOX 655303 • DALLAS, TEXAS 75265

Copyright © 2005, Texas Instruments Incorporated
On products compliant to MIL-PRF-38535, all parameters are tested unless otherwise noted. On all other products, production processing does not necessarily include testing of all parameters.

SN54CBT16212A, SN74CBT16212A 24-BIT FET BUS-EXCHANGE SWITCHES

SCDS007U – NOVEMBER 1992 – REVISED JUNE 2005

GQL OR ZQL PACKAGE
(TOP VIEW)

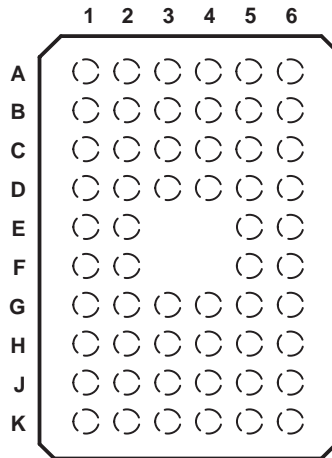

terminal assignments

	1	2	3	4	5	6
A	1A2	1A1	S0	S1	S2	1B1
B	3A1	2A2	2A1	1B2	2B1	2B2
C	4A1	GND	3A2	3B1	GND	3B2
D	5A2	4A2	5A1	4B2	4B1	5B1
E	6A2	6A1			5B2	6B1
F	7A1	7A2			7B1	6B2
G	VCC	GND	8A1	8B1	GND	7B2
H	8A2	9A1	9A2	9B2	9B1	8B2
J	10A1	10A2	11A1	11B1	10B2	10B1
K	11A2	12A1	12A2	12B2	12B1	11B2

FUNCTION TABLE

INPUTS			INPUTS/OUTPUTS		FUNCTION
S2	S1	S0	A1	A2	
L	L	L	Z	Z	Disconnect
L	L	H	B1 port	Z	A1 port = B1 port
L	H	L	B2 port	Z	A1 port = B2 port
L	H	H	Z	B1 port	A2 port = B1 port
H	L	L	Z	B2 port	A2 port = B2 port
H	L	H	Z	Z	Disconnect
H	H	L	B1 port	B2 port	A1 port = B1 port A2 port = B2 port
H	H	H	B2 port	B1 port	A1 port = B2 port A2 port = B1 port

SN54CBT16212A, SN74CBT16212A 24-BIT FET BUS-EXCHANGE SWITCHES

SCDS007U – NOVEMBER 1992 – REVISED JUNE 2005

logic diagram (positive logic)

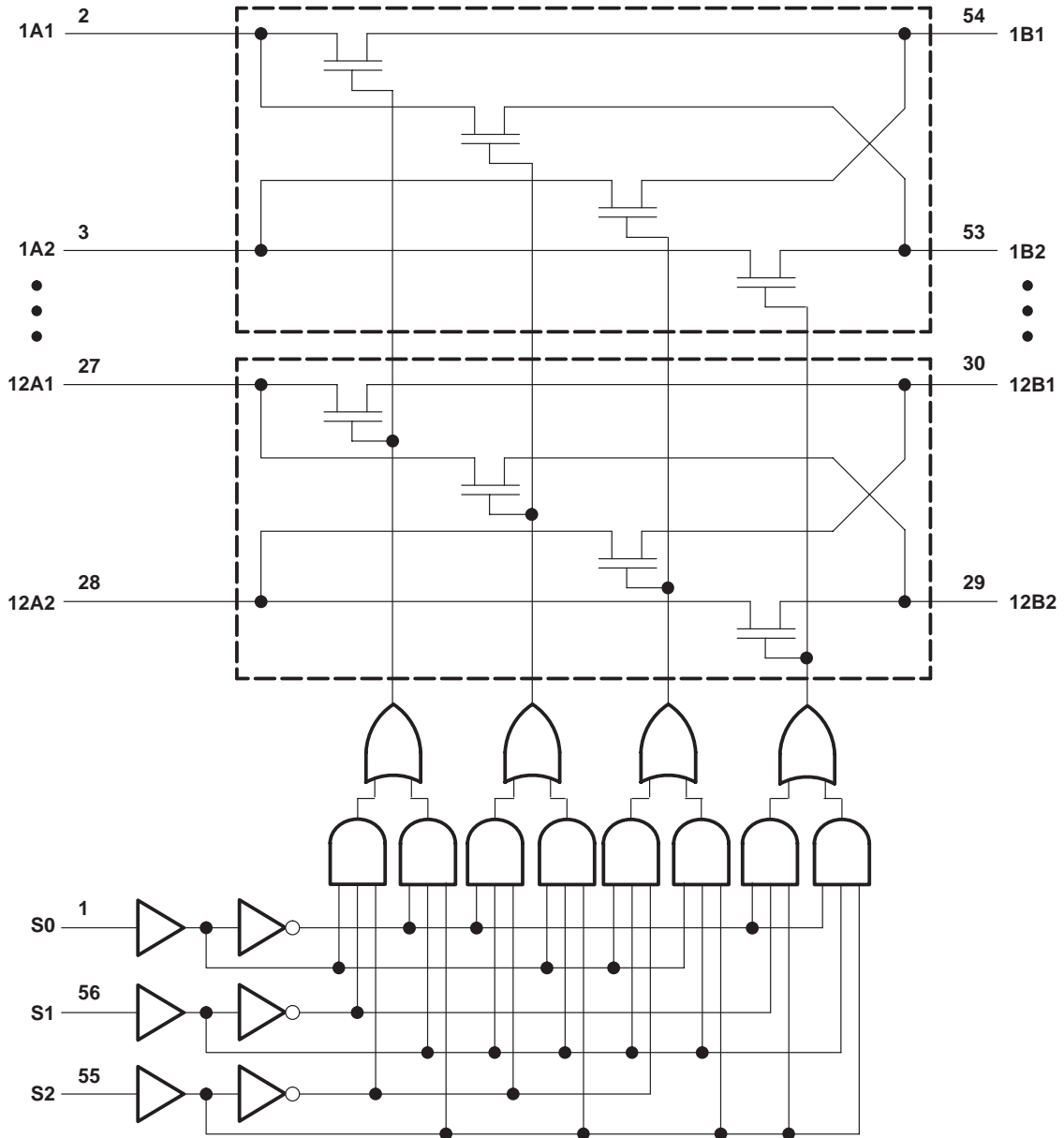

Pin numbers shown are for the DGG, DGV, DL, and WD packages.

SN54CBT16212A, SN74CBT16212A 24-BIT FET BUS-EXCHANGE SWITCHES

SCDS007U – NOVEMBER 1992 – REVISED JUNE 2005

absolute maximum ratings over operating free-air temperature range (unless otherwise noted)†

Supply voltage range, V_{CC}	-0.5 V to 7 V
Input voltage range, V_I (see Note 1)	-0.5 V to 7 V
Continuous channel current	128 mA
Input clamp current, I_{IK} ($V_I < 0$)	-50 mA
Package thermal impedance, θ_{JA} (see Note 2): DGG package	64°C/W
DGV package	48°C/W
DL package	56°C/W
GQL/ZQL package	42°C/W
Storage temperature range, T_{stg}	-65°C to 150°C

† Stresses beyond those listed under “absolute maximum ratings” may cause permanent damage to the device. These are stress ratings only, and functional operation of the device at these or any other conditions beyond those indicated under “recommended operating conditions” is not implied. Exposure to absolute-maximum-rated conditions for extended periods may affect device reliability.

- NOTES: 1. The input and output negative-voltage ratings may be exceeded if the input and output clamp-current ratings are observed.
2. The package thermal impedance is calculated in accordance with JESD 51-7.

recommended operating conditions (see Note 3)

	SN54CBT16212A		SN74CBT16212A		UNIT
	MIN	MAX	MIN	MAX	
V_{CC} Supply voltage	4	5.5	4	5.5	V
V_{IH} High-level control input voltage	2		2		V
V_{IL} Low-level control input voltage		0.8		0.8	V
T_A Operating free-air temperature	-55	125	-40	85	°C

NOTE 3: All unused control inputs of the device must be held at V_{CC} or GND to ensure proper device operation. Refer to the TI application report, *Implications of Slow or Floating CMOS Inputs*, literature number SCBA004.

electrical characteristics over recommended operating free-air temperature range (unless otherwise noted)

PARAMETER	TEST CONDITIONS	SN54CBT16212A		SN74CBT16212A		UNIT		
		MIN	TYP‡	MAX	MIN		TYP‡	MAX
V_{IK}	$V_{CC} = 4.5$ V, $I_I = -18$ mA			-1.2		-1.2	V	
I_I	$V_{CC} = 0$, $V_I = 5.5$ V			10		10	μA	
	$V_{CC} = 5.5$ V, $V_I = 5.5$ V or GND			±1		±1		
I_{CC}	$V_{CC} = 5.5$ V, $I_O = 0$, $V_I = V_{CC}$ or GND			3.2		3	μA	
ΔI_{CC} §	Control inputs $V_{CC} = 5.5$ V, One input at 3.4 V, Other inputs at V_{CC} or GND			2.5		2.5	mA	
C_i	Control inputs $V_I = 3$ V or 0			2.5		2.5	pF	
$C_{io(off)}$	$V_O = 3$ V or 0, $S_0, S_1,$ and $S_2 =$ GND			7.5		7.5	pF	
r_{on} ¶	$V_{CC} = 4$ V, TYP at $V_{CC} = 4$ V	$V_I = 2.4$ V,	$I_I = 15$ mA	14	20	14	20	Ω
	$V_{CC} = 4.5$ V	$V_I = 0$	$I_I = 64$ mA	4	10	4	7	
			$I_I = 30$ mA	4	10	4	7	
		$V_I = 2.4$ V,	$I_I = 15$ mA	6	14	6	12	

‡ All typical values are at $V_{CC} = 5$ V (unless otherwise noted), $T_A = 25^\circ\text{C}$.

§ This is the increase in supply current for each input that is at the specified TTL voltage level, rather than V_{CC} or GND.

¶ Measured by the voltage drop between the A and B terminals at the indicated current through the switch. On-state resistance is determined by the lower of the voltages of the two (A or B) terminals.



SN54CBT16212A, SN74CBT16212A 24-BIT FET BUS-EXCHANGE SWITCHES

SCDS007U – NOVEMBER 1992 – REVISED JUNE 2005

switching characteristics over recommended operating free-air temperature range, $C_L = 50$ pF (unless otherwise noted) (see Figure 1)

PARAMETER	FROM (INPUT)	TO (OUTPUT)	SN54CBT16212A				SN74CBT16212A				UNIT
			$V_{CC} = 4$ V		$V_{CC} = 5$ V ± 0.5 V		$V_{CC} = 4$ V		$V_{CC} = 5$ V ± 0.5 V		
			MIN	MAX	MIN	MAX	MIN	MAX	MIN	MAX	
t_{pd}^\dagger	A or B	B or A				0.8*		0.35		0.25	ns
t_{pd}	S	A or B		14	1.5	13		10	1.5	9.1	ns
t_{en}	S	A or B		15	1.5	13.7		10.4	1.5	9.7	ns
t_{dis}	S	A or B		14.2	1.5	13.5		9.2	1.5	8.8	ns

* On products compliant to MIL-PRF-38535, this parameter is not production tested.

† The propagation delay is the calculated RC time constant of the typical on-state resistance of the switch and the specified load capacitance, when driven by an ideal voltage source (zero output impedance).

PARAMETER MEASUREMENT INFORMATION

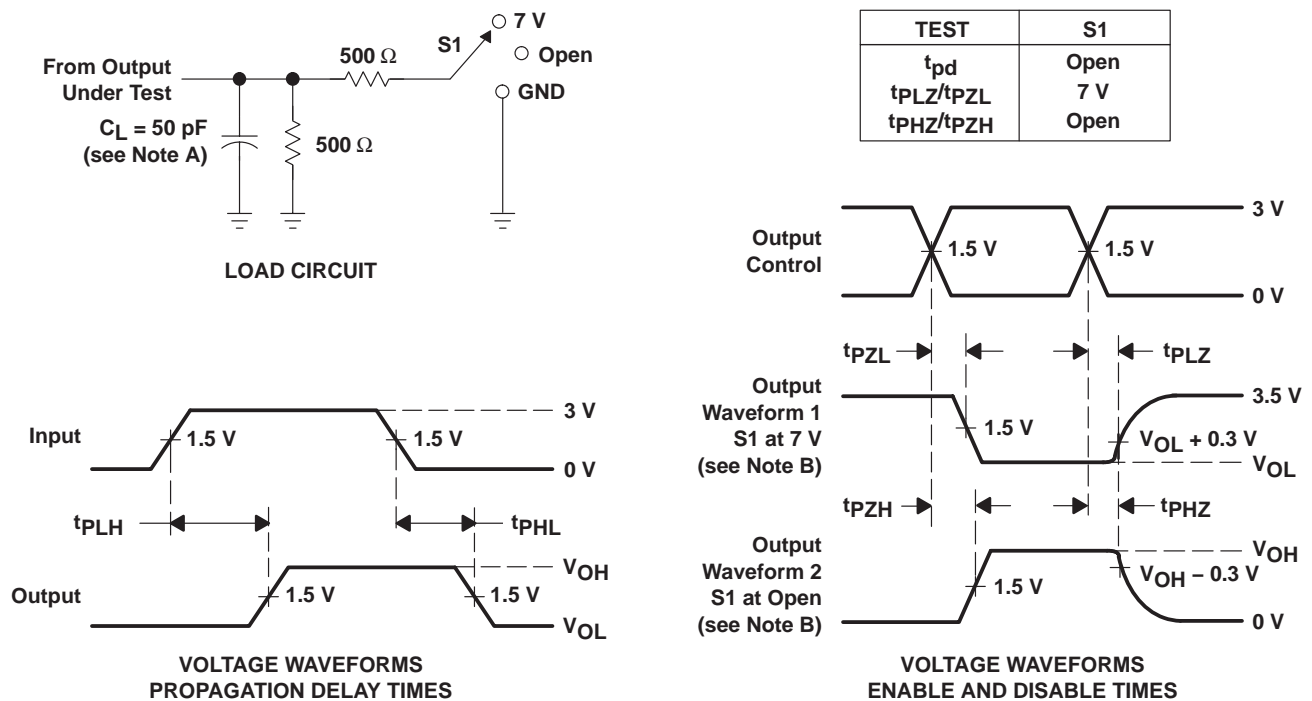

- NOTES:
- C_L includes probe and jig capacitance.
 - Waveform 1 is for an output with internal conditions such that the output is low, except when disabled by the output control. Waveform 2 is for an output with internal conditions such that the output is high, except when disabled by the output control.
 - All input pulses are supplied by generators having the following characteristics: $PRR \leq 10$ MHz, $Z_O = 50$ Ω , $t_r \leq 2.5$ ns, $t_f \leq 2.5$ ns.
 - The outputs are measured one at a time, with one transition per measurement.
 - t_{PLZ} and t_{PHZ} are the same as t_{dis} .
 - t_{PZL} and t_{PZH} are the same as t_{en} .
 - t_{PLH} and t_{PHL} are the same as t_{pd} .
 - All parameters and waveforms are not applicable to all devices.

Figure 1. Load Circuit and Voltage Waveforms

PACKAGING INFORMATION

Orderable Device	Status (1)	Package Type	Package Drawing	Pins	Package Qty	Eco Plan (2)	Lead/Ball Finish (6)	MSL Peak Temp (3)	Op Temp (°C)	Device Marking (4/5)	Samples
SN74CBT16212ADGGR	ACTIVE	TSSOP	DGG	56	2000	Green (RoHS & no Sb/Br)	CU NIPDAU	Level-1-260C-UNLIM	-40 to 85	CBT16212A	Samples
SN74CBT16212ADL	ACTIVE	SSOP	DL	56	20	Green (RoHS & no Sb/Br)	CU NIPDAU	Level-1-260C-UNLIM	-40 to 85	CBT16212A	Samples
SN74CBT16212ADLR	ACTIVE	SSOP	DL	56	1000	Green (RoHS & no Sb/Br)	CU NIPDAU	Level-1-260C-UNLIM	-40 to 85	CBT16212A	Samples
SN74CBT16212ADLRG4	ACTIVE	SSOP	DL	56	1000	Green (RoHS & no Sb/Br)	CU NIPDAU	Level-1-260C-UNLIM	-40 to 85	CBT16212A	Samples
SN74CBT16212AZQLR	LIFEBUY	BGA MICROSTAR JUNIOR	ZQL	56	1000	Green (RoHS & no Sb/Br)	SNAGCU	Level-1-260C-UNLIM	-40 to 85	CY212A	
SNJ54CBT16212AWD	LIFEBUY	CFP	WD	56		TBD	Call TI	Call TI	-55 to 125	5962-9852101QX A SNJ54CBT16212A WD	

(1) The marketing status values are defined as follows:

ACTIVE: Product device recommended for new designs.

LIFEBUY: TI has announced that the device will be discontinued, and a lifetime-buy period is in effect.

NRND: Not recommended for new designs. Device is in production to support existing customers, but TI does not recommend using this part in a new design.

PREVIEW: Device has been announced but is not in production. Samples may or may not be available.

OBSOLETE: TI has discontinued the production of the device.

(2) **RoHS:** TI defines "RoHS" to mean semiconductor products that are compliant with the current EU RoHS requirements for all 10 RoHS substances, including the requirement that RoHS substance do not exceed 0.1% by weight in homogeneous materials. Where designed to be soldered at high temperatures, "RoHS" products are suitable for use in specified lead-free processes. TI may reference these types of products as "Pb-Free".

RoHS Exempt: TI defines "RoHS Exempt" to mean products that contain lead but are compliant with EU RoHS pursuant to a specific EU RoHS exemption.

Green: TI defines "Green" to mean the content of Chlorine (Cl) and Bromine (Br) based flame retardants meet JS709B low halogen requirements of <=1000ppm threshold. Antimony trioxide based flame retardants must also meet the <=1000ppm threshold requirement.

(3) MSL, Peak Temp. - The Moisture Sensitivity Level rating according to the JEDEC industry standard classifications, and peak solder temperature.

(4) There may be additional marking, which relates to the logo, the lot trace code information, or the environmental category on the device.

(5) Multiple Device Markings will be inside parentheses. Only one Device Marking contained in parentheses and separated by a "~" will appear on a device. If a line is indented then it is a continuation of the previous line and the two combined represent the entire Device Marking for that device.

⁽⁶⁾ Lead/Ball Finish - Orderable Devices may have multiple material finish options. Finish options are separated by a vertical ruled line. Lead/Ball Finish values may wrap to two lines if the finish value exceeds the maximum column width.

Important Information and Disclaimer:The information provided on this page represents TI's knowledge and belief as of the date that it is provided. TI bases its knowledge and belief on information provided by third parties, and makes no representation or warranty as to the accuracy of such information. Efforts are underway to better integrate information from third parties. TI has taken and continues to take reasonable steps to provide representative and accurate information but may not have conducted destructive testing or chemical analysis on incoming materials and chemicals. TI and TI suppliers consider certain information to be proprietary, and thus CAS numbers and other limited information may not be available for release.

In no event shall TI's liability arising out of such information exceed the total purchase price of the TI part(s) at issue in this document sold by TI to Customer on an annual basis.

OTHER QUALIFIED VERSIONS OF SN54CBT16212A, SN74CBT16212A :

- Catalog: [SN74CBT16212A](#)
- Military: [SN54CBT16212A](#)

NOTE: Qualified Version Definitions:

- Catalog - TI's standard catalog product
- Military - QML certified for Military and Defense Applications

TAPE AND REEL INFORMATION



QUADRANT ASSIGNMENTS FOR PIN 1 ORIENTATION IN TAPE



*All dimensions are nominal

Device	Package Type	Package Drawing	Pins	SPQ	Reel Diameter (mm)	Reel Width W1 (mm)	A0 (mm)	B0 (mm)	K0 (mm)	P1 (mm)	W (mm)	Pin1 Quadrant
SN74CBT16212ADGGR	TSSOP	DGG	56	2000	330.0	24.4	8.6	15.6	1.8	12.0	24.0	Q1
SN74CBT16212ADLR	SSOP	DL	56	1000	330.0	32.4	11.35	18.67	3.1	16.0	32.0	Q1
SN74CBT16212AZQLR	BGA MICROSTAR JUNIOR	ZQL	56	1000	330.0	16.4	4.8	7.3	1.5	8.0	16.0	Q1

TAPE AND REEL BOX DIMENSIONS

*All dimensions are nominal

Device	Package Type	Package Drawing	Pins	SPQ	Length (mm)	Width (mm)	Height (mm)
SN74CBT16212ADGGR	TSSOP	DGG	56	2000	367.0	367.0	45.0
SN74CBT16212ADLR	SSOP	DL	56	1000	367.0	367.0	55.0
SN74CBT16212AZQLR	BGA MICROSTAR JUNIOR	ZQL	56	1000	350.0	350.0	43.0

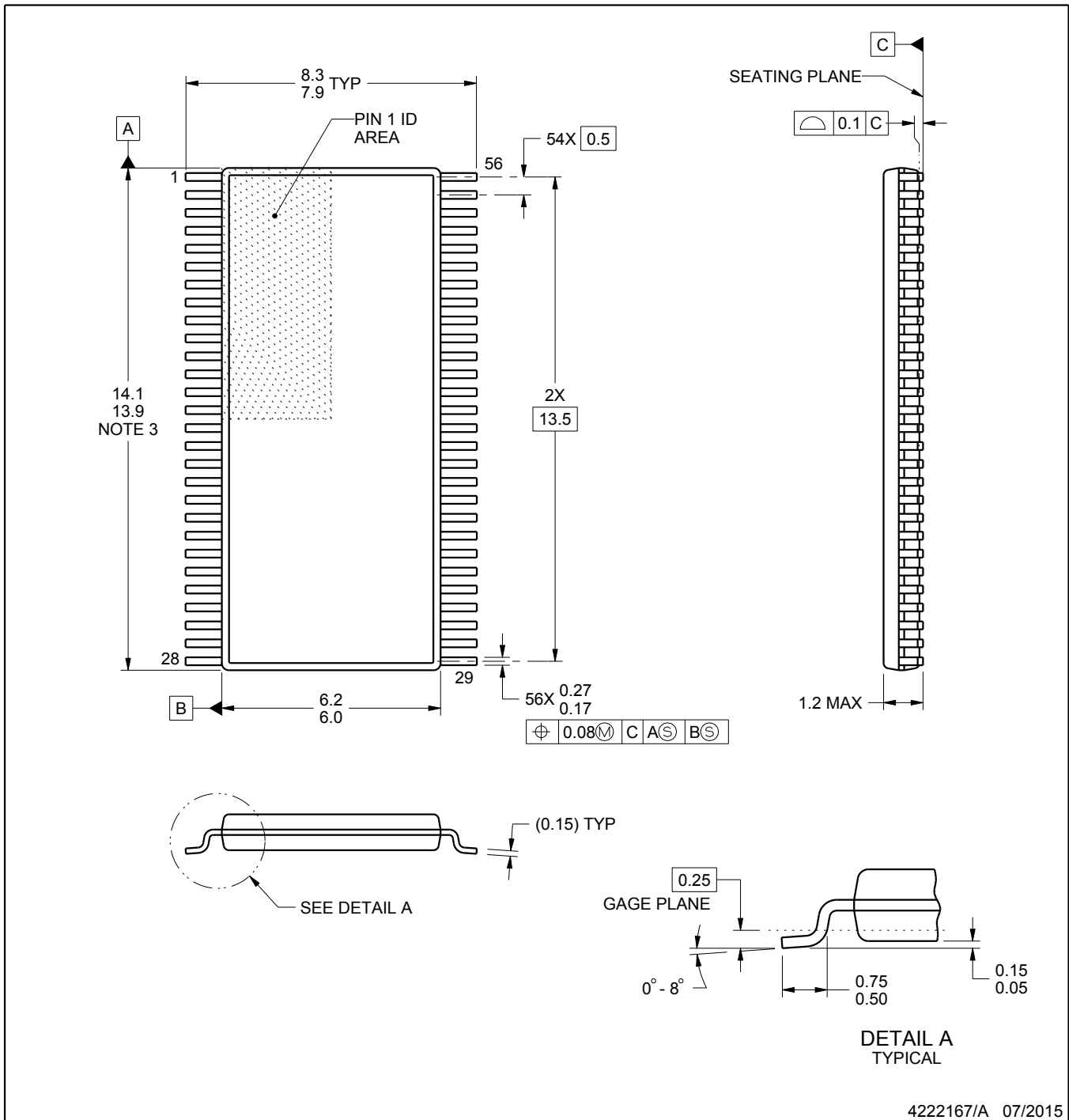

4222167/A 07/2015

NOTES:

- All linear dimensions are in millimeters. Any dimensions in parenthesis are for reference only. Dimensioning and tolerancing per ASME Y14.5M.
- This drawing is subject to change without notice.
- This dimension does not include mold flash, protrusions, or gate burrs. Mold flash, protrusions, or gate burrs shall not exceed 0.15 mm per side.
- Reference JEDEC registration MO-153.

EXAMPLE BOARD LAYOUT

DGG0056A

TSSOP - 1.2 mm max height

SMALL OUTLINE PACKAGE

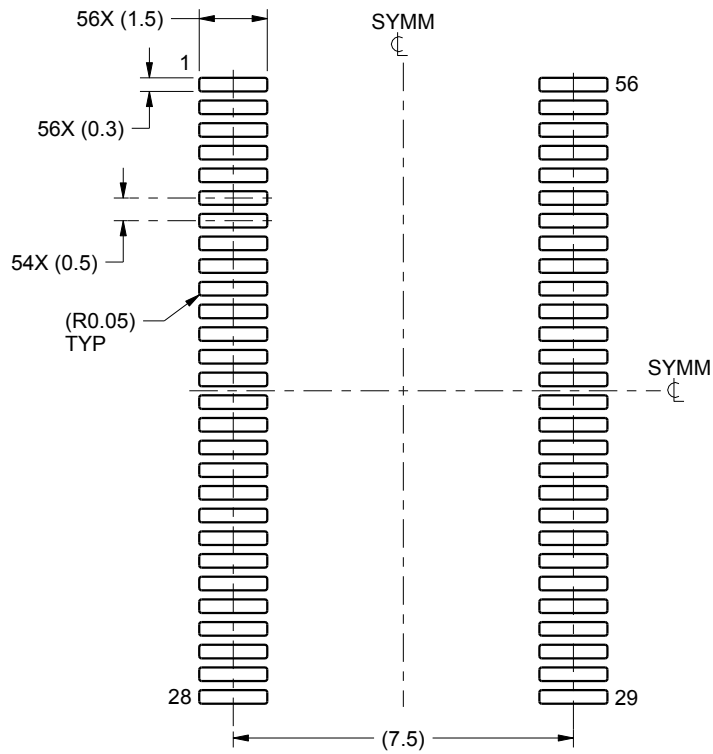

LAND PATTERN EXAMPLE
SCALE:6X

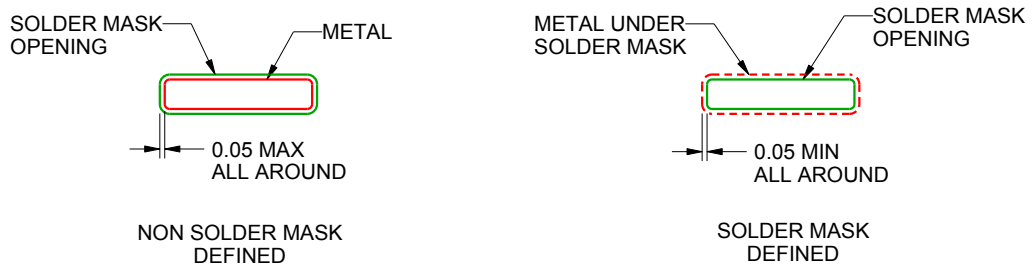

SOLDER MASK DETAILS

4222167/A 07/2015

NOTES: (continued)

- 5. Publication IPC-7351 may have alternate designs.
- 6. Solder mask tolerances between and around signal pads can vary based on board fabrication site.

EXAMPLE STENCIL DESIGN

DGG0056A

TSSOP - 1.2 mm max height

SMALL OUTLINE PACKAGE

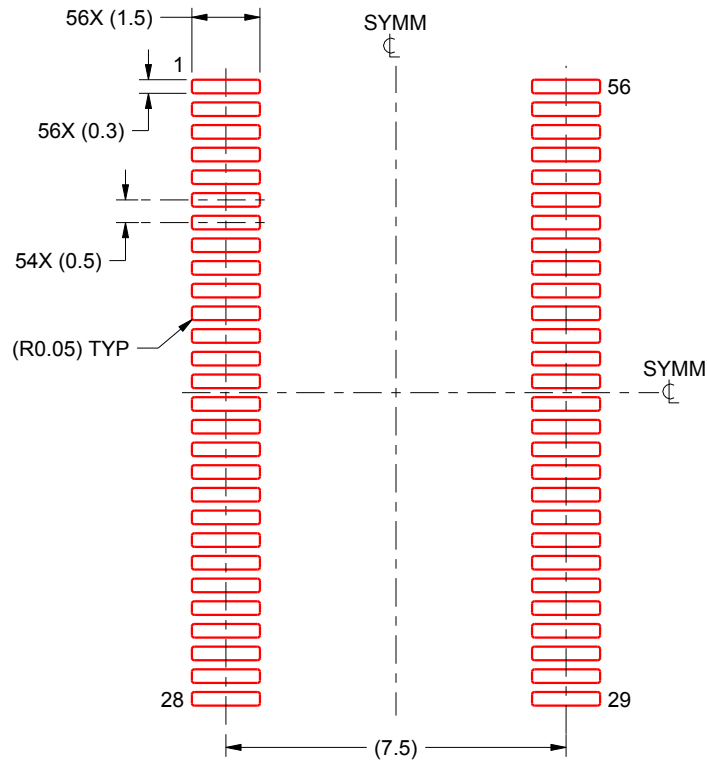

SOLDER PASTE EXAMPLE
BASED ON 0.125 mm THICK STENCIL
SCALE:6X

4222167/A 07/2015

NOTES: (continued)

7. Laser cutting apertures with trapezoidal walls and rounded corners may offer better paste release. IPC-7525 may have alternate design recommendations.
8. Board assembly site may have different recommendations for stencil design.

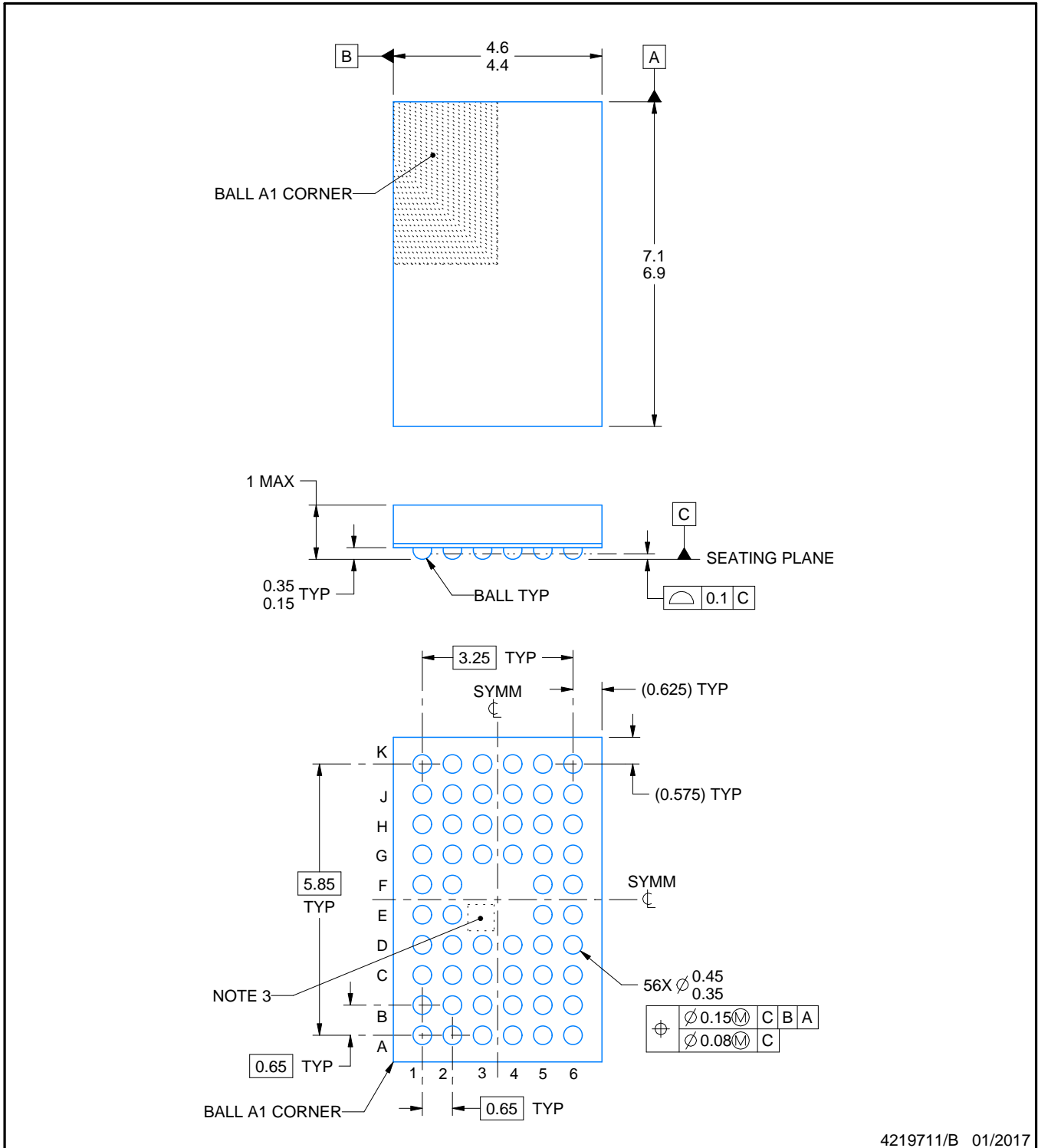
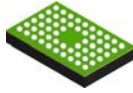

4219711/B 01/2017

NOTES:

1. All linear dimensions are in millimeters. Any dimensions in parenthesis are for reference only. Dimensioning and tolerancing per ASME Y14.5M.
2. This drawing is subject to change without notice.
3. No metal in this area, indicates orientation.

EXAMPLE BOARD LAYOUT

ZQL0056A

JRBGA - 1 mm max height

PLASTIC BALL GRID ARRAY

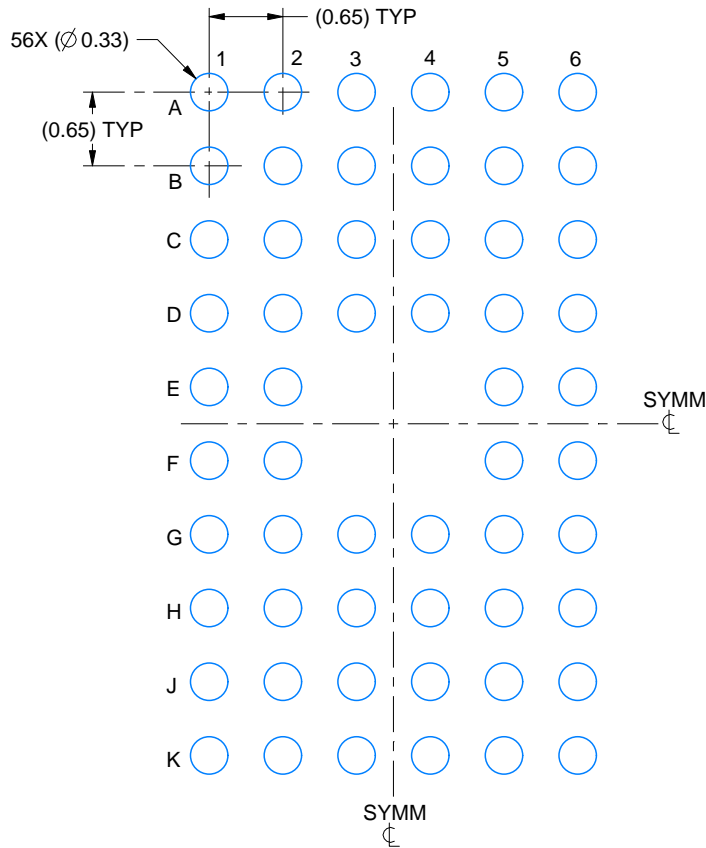

LAND PATTERN EXAMPLE
EXPOSED METAL SHOWN
SCALE:15X

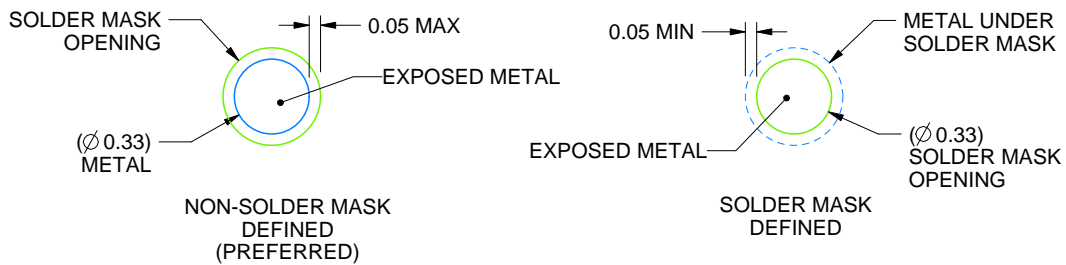

SOLDER MASK DETAILS
NOT TO SCALE

4219711/B 01/2017

NOTES: (continued)

- Final dimensions may vary due to manufacturing tolerance considerations and also routing constraints. For information, see Texas Instruments literature number SPRAA99 (www.ti.com/lit/spraa99).

EXAMPLE STENCIL DESIGN

ZQL0056A

JRBGA - 1 mm max height

PLASTIC BALL GRID ARRAY

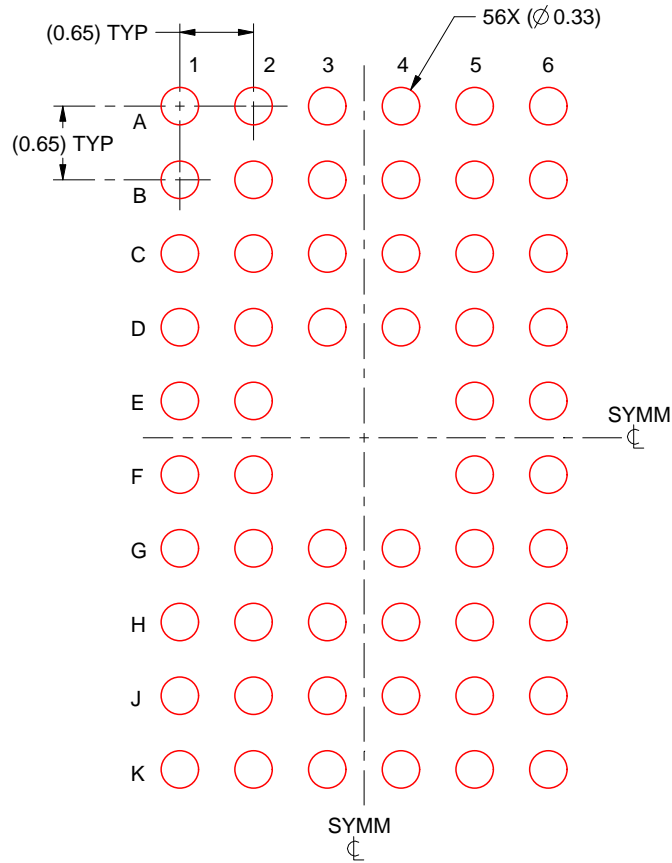

SOLDER PASTE EXAMPLE
BASED ON 0.125 mm THICK STENCIL
SCALE:15X

4219711/B 01/2017

NOTES: (continued)

5. Laser cutting apertures with trapezoidal walls and rounded corners may offer better paste release.

WD (R-GDFP-F**)

CERAMIC DUAL FLATPACK

48 LEADS SHOWN

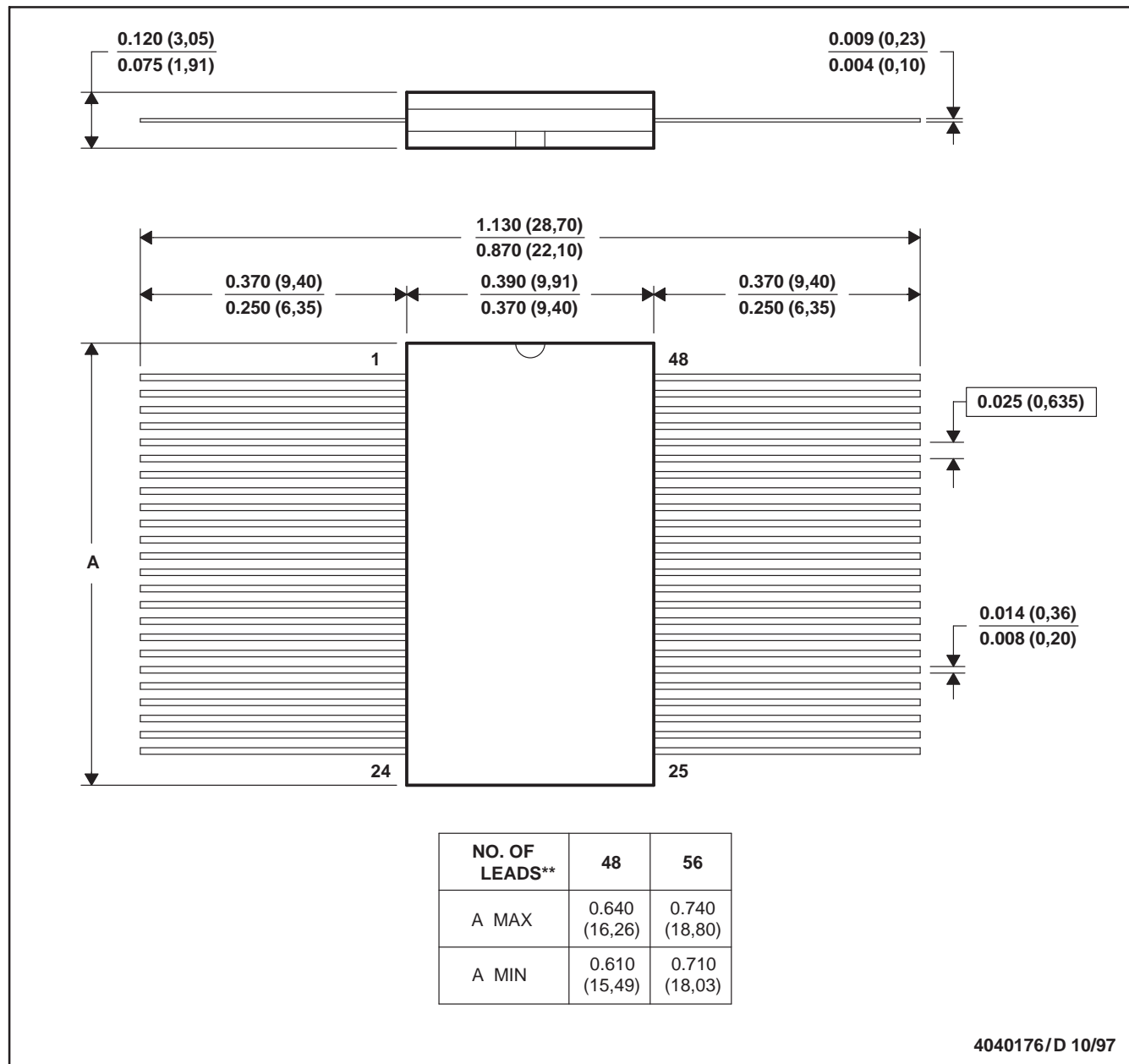

- NOTES: A. All linear dimensions are in inches (millimeters).
 B. This drawing is subject to change without notice.
 C. This package can be hermetically sealed with a ceramic lid using glass frit.
 D. Index point is provided on cap for terminal identification only
 E. Falls within MIL STD 1835: GDFP1-F48 and JEDEC MO-146AA
 GDFP1-F56 and JEDEC MO-146AB

IMPORTANT NOTICE AND DISCLAIMER

TI PROVIDES TECHNICAL AND RELIABILITY DATA (INCLUDING DATASHEETS), DESIGN RESOURCES (INCLUDING REFERENCE DESIGNS), APPLICATION OR OTHER DESIGN ADVICE, WEB TOOLS, SAFETY INFORMATION, AND OTHER RESOURCES "AS IS" AND WITH ALL FAULTS, AND DISCLAIMS ALL WARRANTIES, EXPRESS AND IMPLIED, INCLUDING WITHOUT LIMITATION ANY IMPLIED WARRANTIES OF MERCHANTABILITY, FITNESS FOR A PARTICULAR PURPOSE OR NON-INFRINGEMENT OF THIRD PARTY INTELLECTUAL PROPERTY RIGHTS.

These resources are intended for skilled developers designing with TI products. You are solely responsible for (1) selecting the appropriate TI products for your application, (2) designing, validating and testing your application, and (3) ensuring your application meets applicable standards, and any other safety, security, or other requirements. These resources are subject to change without notice. TI grants you permission to use these resources only for development of an application that uses the TI products described in the resource. Other reproduction and display of these resources is prohibited. No license is granted to any other TI intellectual property right or to any third party intellectual property right. TI disclaims responsibility for, and you will fully indemnify TI and its representatives against, any claims, damages, costs, losses, and liabilities arising out of your use of these resources.

TI's products are provided subject to TI's Terms of Sale (www.ti.com/legal/termsofsale.html) or other applicable terms available either on ti.com or provided in conjunction with such TI products. TI's provision of these resources does not expand or otherwise alter TI's applicable warranties or warranty disclaimers for TI products.

Mailing Address: Texas Instruments, Post Office Box 655303, Dallas, Texas 75265
Copyright © 2019, Texas Instruments Incorporated

Looking for pricing, stock, or lifecycle information?

Click below to explore more details on WIN SOURCE:

- ⊖ [View SN74CBT16212ADLR on WIN SOURCE](#)
- ⊖ [Texas Instruments](#) Information

Optimize Your Supply Chain with WIN SOURCE Solutions

- ✓ Global Sourcing Solution
- ✓ Obsolete Management
- ✓ Cost Control Management
- ✓ Shortage Management
- ✓ Alternative Solution
- ✓ Excess Inventory Management