



THE DATASHEET OF CAT8900D250TBGT3



CAT8900

Precision Analog Voltage References

The CAT8900 is a high precision voltage reference providing very accurate voltage regulation with low supply current consumption.

CAT8900 is ideal for use in battery powered systems where operating current needs to be minimized and there can be a great variation in supply voltages. It will source or sink up to 10 mA of load current, and can for most applications, forgo the use of an output bypass capacitor. The device is supplied in a space saving three terminal SOT-23 package.

Features

- Reference Voltages:
1.024 V, 1.200 V, 1.250 V, 1.800 V,
2.048 V, 2.500 V, 2.600 V,
3.000 V, 3.300 V
- Low Supply Current: 450 nA (Typical)
- Initial Accuracy:
Class B: ± 1.0 mV
Class C: ± 2.5 mV
Class D: ± 5.0 mV
- Drift Performance: 50 ppm/ $^{\circ}$ C
- SOT-23 3-Lead Package
- This Device is Pb-Free, Halogen Free/BFR Free, and RoHS Compliant

Typical Applications

- Battery Powered Systems
- A/D and D/A Converters
- Precision Regulator Systems
- Power Supplies
- Portable Medical Equipment

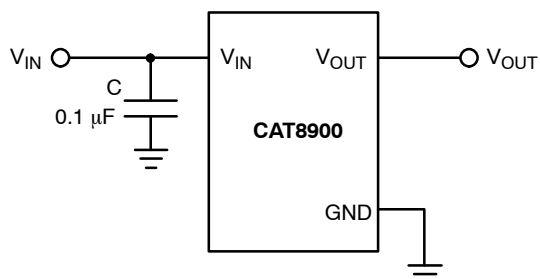
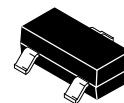

Figure 1. Application Circuit



ON Semiconductor®

<http://onsemi.com>



SOT23-3
TP, TB SUFFIX
CASE 527AG

MARKING DIAGRAM

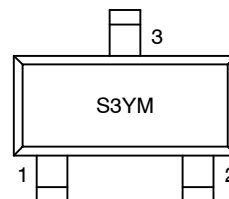

S3 = Specific Device Code
Y = Production Year
(Last Digit)
M = Production Month
(1 - 9, A, B, C)

PIN CONNECTIONS

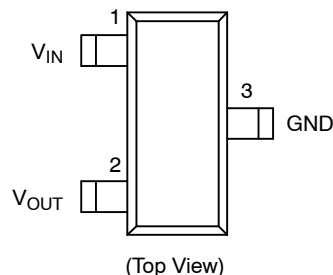

PIN FUNCTIONS

Pin No.	Pin Name	Function
1	V _{IN}	Supply Voltage Input
2	V _{OUT}	Output Voltage
3	GND	Ground

ORDERING INFORMATION

See detailed ordering and shipping information in the package dimensions section on page 2 of this data sheet.

CAT8900

Table 1. ORDERING INFORMATION

Orderable Part Number	Initial Accuracy (±mV)	Initial Accuracy (%)	V _{OUT} Voltage (V) (Note 1)	Package	Shipping [†]
CAT8900B102TBGT3	1.0	0.10%	1.024	SOT-23	3,000
CAT8900C102TBGT3	2.5	0.24%			
CAT8900D102TBGT3	5.0	0.49%			
CAT8900B120TBGT3	1.0	0.08%	1.200		
CAT8900C120TBGT3	2.5	0.21%			
CAT8900D120TBGT3	5.0	0.42%			
CAT8900B125TBGT3	1.0	0.08%	1.250		
CAT8900C125TBGT3	2.5	0.20%			
CAT8900D125TBGT3	5.0	0.40%			
CAT8900B180TBGT3	1.0	0.06%	1.800		
CAT8900C180TBGT3	2.5	0.14%			
CAT8900D180TBGT3	5.0	0.28%			
CAT8900B204TBGT3	1.0	0.05%	2.048		
CAT8900C204TBGT3	2.5	0.12%			
CAT8900D204TBGT3	5.0	0.24%			
CAT8900B250TBGT3	1.0	0.04%	2.500		
CAT8900C250TBGT3	2.5	0.10%			
CAT8900D250TBGT3	5.0	0.20%			
CAT8900B260TBGT3	1.0	0.04%	2.600		
CAT8900C260TBGT3	2.5	0.10%			
CAT8900D260TBGT3	5.0	0.19%			
CAT8900B300TBGT3	1.0	0.03%	3.000		
CAT8900C300TBGT3	2.5	0.08%			
CAT8900D300TBGT3	5.0	0.17%			
CAT8900B330TBGT3	1.0	0.03%	3.300		
CAT8900C330TBGT3	2.5	0.08%			
CAT8900D330TBGT3	5.0	0.15%			

1. Contact factory for availability of these and other custom voltages.

†For information on tape and reel specifications, including part orientation and tape sizes, please refer to our Tape and Reel Packaging Specifications Brochure, BRD8011/D.

CAT8900

Table 2. ABSOLUTE MAXIMUM RATINGS (Note 2)

Rating	Value	Unit
V_{IN}	6.5	V
Storage Temperature Range	-55 to +125	°C
Junction Temperature Range	+150	°C

Stresses exceeding Maximum Ratings may damage the device. Maximum Ratings are stress ratings only. Functional operation above the Recommended Operating Conditions is not implied. Extended exposure to stresses above the Recommended Operating Conditions may affect device reliability.

2. Maximum terminal current is bounded by the maximum current handling of the switches, maximum power dissipation of the package.

Table 3. RECOMMENDED OPERATING CONDITIONS

Rating	Value	Unit
Temperature Range	-40 to +85	°C

Table 4. ELECTRICAL CHARACTERISTICS

$V_{IN} = 3.0$ V, $I_{OUT} = 0$ mA, $C_{OUT} = 0.001$ μ F, -40°C to +85°C unless specified otherwise.

Parameter	Test Conditions	Symbol	Min	Typ	Max	Unit
Output Voltage	CAT8900x102	V_{OUT}		1.024		V
	CAT8900x120			1.200		
	CAT8900x125			1.250		
	CAT8900x180			1.800		
	CAT8900x204			2.048		
	CAT8900x250			2.500		
	CAT8900x260			2.600		
	CAT8900x300 ($V_{IN} = 5.0$ V)			3.000		
	CAT8900x330 ($V_{IN} = 5.0$ V)			3.300		
Initial Accuracy	Grade B ($T_A = 25^\circ\text{C}$)		-1.0		+1.0	mV
	Grade C ($T_A = 25^\circ\text{C}$)		-2.5		+2.5	
	Grade D ($T_A = 25^\circ\text{C}$)		-5.0		+5.0	
Output Voltage Noise (Note 3)	$f = 0.1$ Hz to 10 Hz			50		μ Vp-p
Output Voltage Temperature Drift	-40°C to 85°C	$\Delta V_{OUT} \div \Delta T$		20	50	ppm/°C
Thermal Hysteresis (Note 3)	$\Delta T_A = 125^\circ\text{C}$	$\Delta V_{OUT} \div \Delta T_A$		100		ppm
Line Regulation	2.7 V < V_{IN} < 5.5 V	$\Delta V_{OUT} \div \Delta V_{IN}$		30	100	μ V/V
Dropout Voltage	$V_{IN} = 3.0$ V, CAT8900x250	V_{DO}		1.0	2.5	mV
Load Regulation Sourcing	0 mA < $I_{LOAD} < 10$ mA; $V_{IN} = 3$ V	$\Delta V_{OUT} \div \Delta I_{LOAD}$		100	250	μ V/mA
Sinking	-10 mA < $I_{LOAD} < 0$ mA; $V_{IN} = 3$ V			150	350	μ V/mA
Long Term Stability (Note 3)	$T_A = 25^\circ\text{C}$; first 1000 hours	$\Delta V_{OUT} \div \Delta t$		50		ppm
Output Current		I_{LOAD}	-10		+10	mA
Short Circuit Current (Note 3)	$T_A = 25^\circ\text{C}$ V_{OUT} pin shorted to GND V_{OUT} pin shorted to V_{IN}	I_{SC}		40	60	mA
				20	40	
Turn-on Settling Time	0.1% @ $V_{IN} = 3$ V; $C_L = 0$ pF			2		ms

POWER SUPPLY

Input Voltage	$I_L = 0$ mA	V_{IN}	2.7		5.5	V
Supply current		I_{IN}		450	800	nA

3. Guaranteed by design.

CAT8900

TYPICAL CHARACTERISTICS

($V_{IN} = 3.0\text{ V}$, $I_{OUT} = 0\text{ mA}$, ambient temperature of 25°C , unless specified otherwise.)

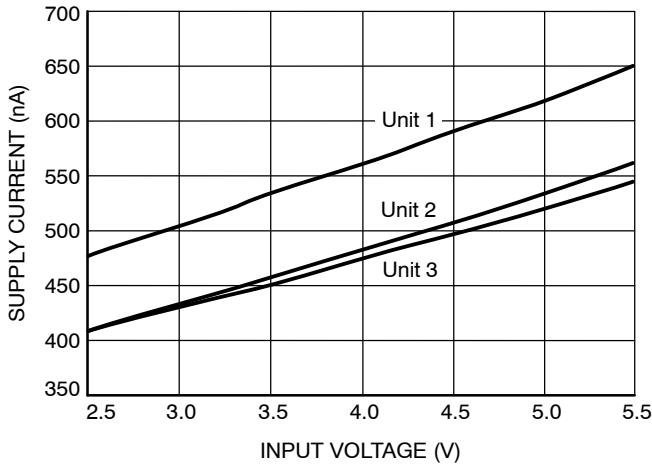

Figure 2. Supply Current vs. Input Voltage

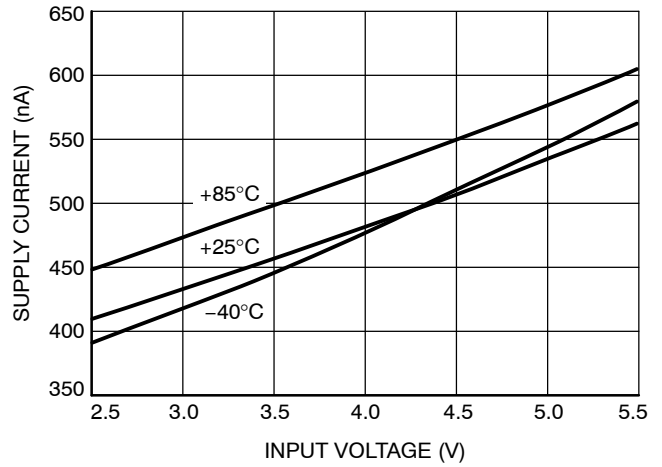

Figure 3. Supply Current vs. Input Voltage Over Temperature

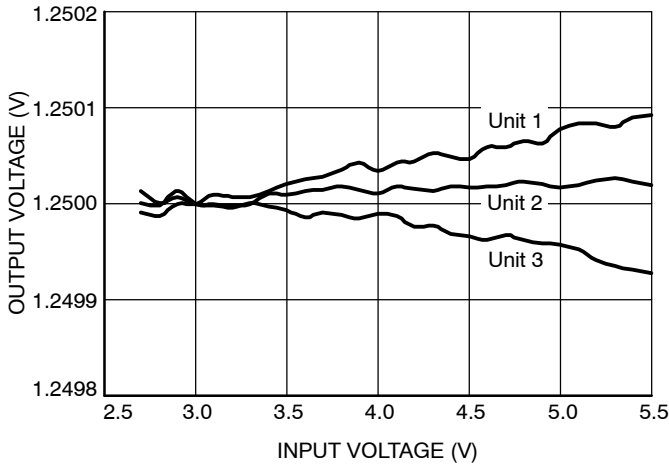

Figure 4. Line Regulation

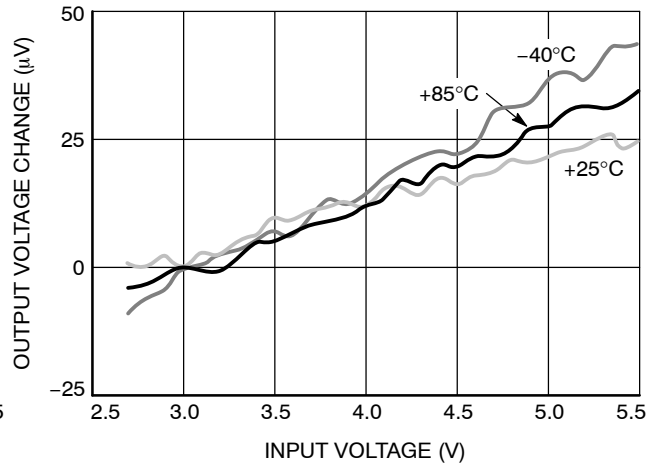

Figure 5. Line Regulation Over Temperature Normalized

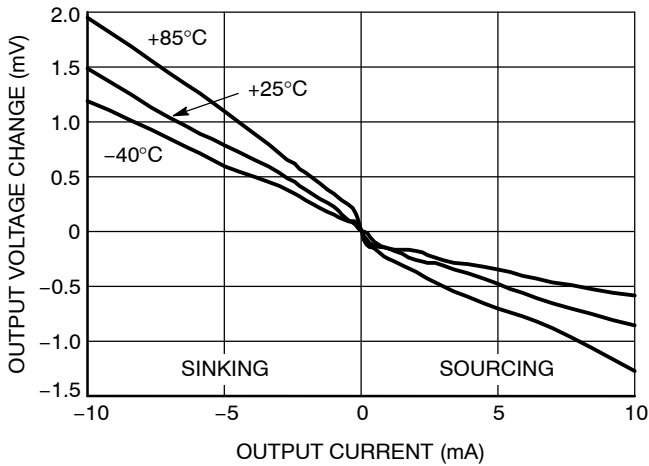

Figure 6. Load Regulation Over Temperature

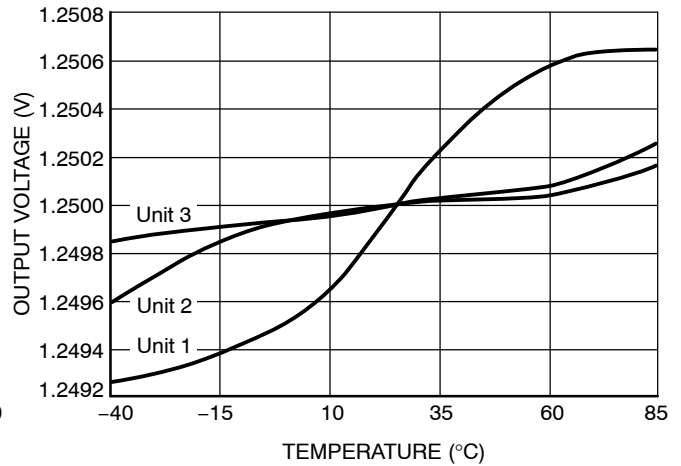
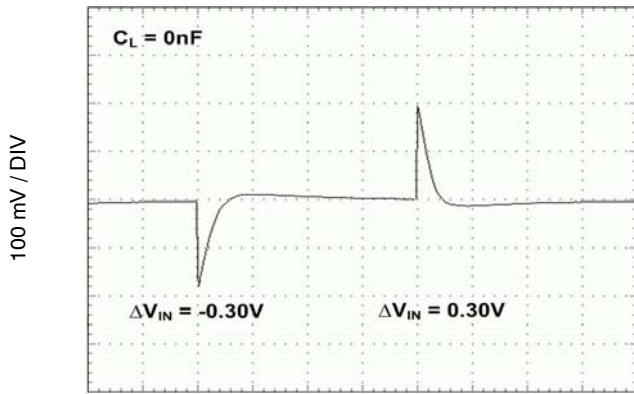

Figure 7. Output Voltage vs. Temperature Normalized

TYPICAL CHARACTERISTICS

($V_{IN} = 3.0\text{ V}$, $I_{OUT} = 0\text{ mA}$, ambient temperature of 25°C , unless specified otherwise.)



1 ms / DIV

Figure 8. Line Transient Response

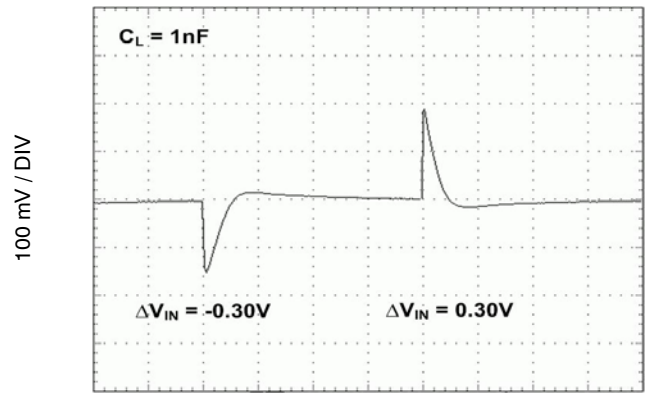

1 ms / DIV

Figure 9. Line Transient Response with Capacitive Load

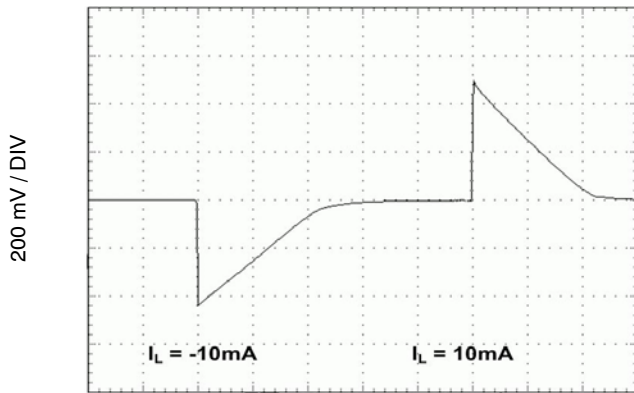

500 μs / DIV

Figure 10. Load Transient Response

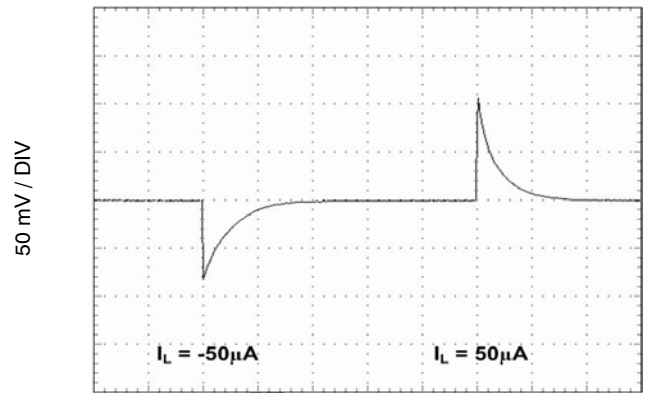

500 μs / DIV

Figure 11. Load Transient Response

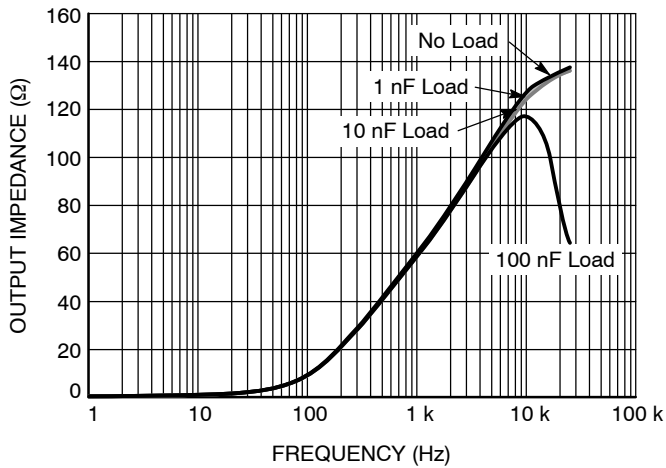

Figure 12. Output Impedance vs. Frequency

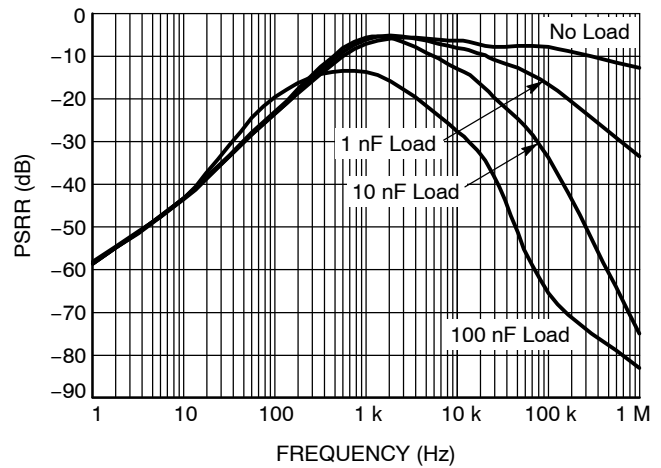
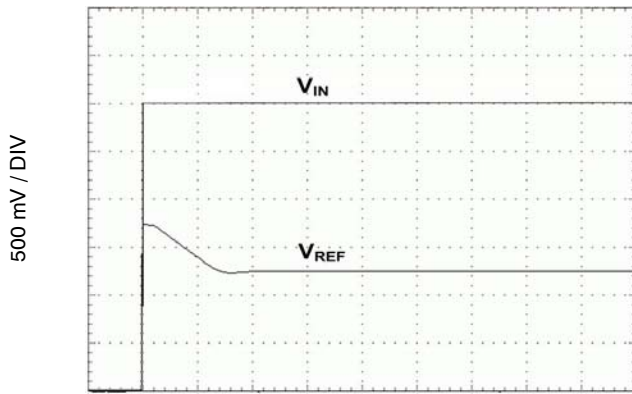

Figure 13. Power Supply Rejection Ratio vs. Frequency

CAT8900

TYPICAL CHARACTERISTICS

($V_{IN} = 3.0\text{ V}$, $I_{OUT} = 0\text{ mA}$, ambient temperature of 25°C , unless specified otherwise.)



1 ms / DIV

Figure 14. Turn-On Time

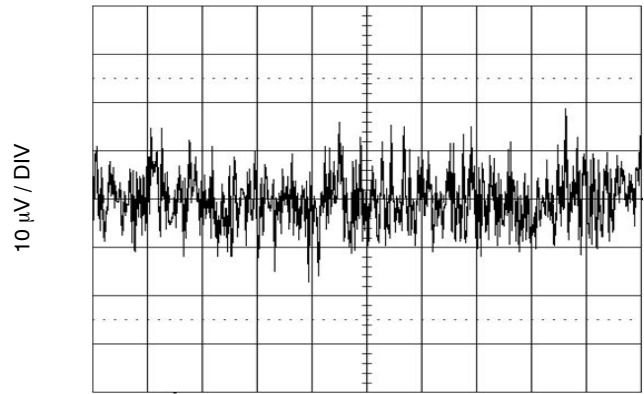

10 s / DIV

Figure 15. Output Noise

CAT8900

PACKAGE DIMENSIONS

SOT-23, 3 Lead
CASE 527AG-01
ISSUE O

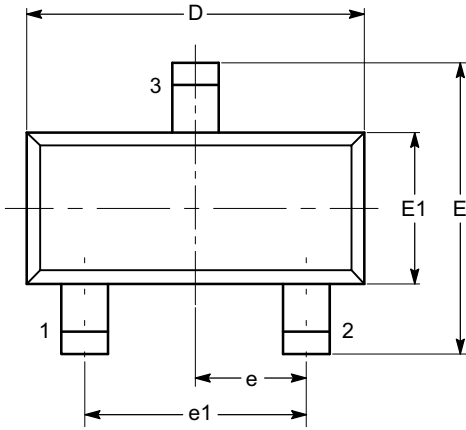

TOP VIEW

SYMBOL	MIN	NOM	MAX
A	0.89		1.12
A1	0.013		0.10
b	0.37		0.50
c	0.085		0.18
D	2.80		3.04
E	2.10		2.64
E1	1.20		1.40
e	0.95 BSC		
e1	1.90 BSC		
L	0.40 REF		
L1	0.54 REF		
θ	0°		8°

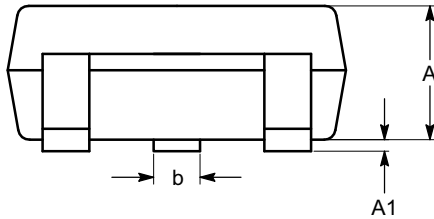

SIDE VIEW

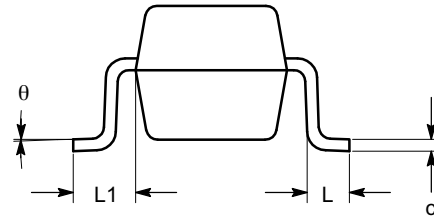

END VIEW

Notes:

- (1) All dimensions are in millimeters. Angles in degrees.
- (2) Complies with JEDEC TO-236.

ON Semiconductor and are registered trademarks of Semiconductor Components Industries, LLC (SCILLC). SCILLC reserves the right to make changes without further notice to any products herein. SCILLC makes no warranty, representation or guarantee regarding the suitability of its products for any particular purpose, nor does SCILLC assume any liability arising out of the application or use of any product or circuit, and specifically disclaims any and all liability, including without limitation special, consequential or incidental damages. "Typical" parameters which may be provided in SCILLC data sheets and/or specifications can and do vary in different applications and actual performance may vary over time. All operating parameters, including "Typicals" must be validated for each customer application by customer's technical experts. SCILLC does not convey any license under its patent rights nor the rights of others. SCILLC products are not designed, intended, or authorized for use as components in systems intended for surgical implant into the body, or other applications intended to support or sustain life, or for any other application in which the failure of the SCILLC product could create a situation where personal injury or death may occur. Should Buyer purchase or use SCILLC products for any such unintended or unauthorized application, Buyer shall indemnify and hold SCILLC and its officers, employees, subsidiaries, affiliates, and distributors harmless against all claims, costs, damages, and expenses, and reasonable attorney fees arising out of, directly or indirectly, any claim of personal injury or death associated with such unintended or unauthorized use, even if such claim alleges that SCILLC was negligent regarding the design or manufacture of the part. SCILLC is an Equal Opportunity/Affirmative Action Employer. This literature is subject to all applicable copyright laws and is not for resale in any manner.

PUBLICATION ORDERING INFORMATION

LITERATURE FULFILLMENT:
Literature Distribution Center for ON Semiconductor
P.O. Box 5163, Denver, Colorado 80217 USA
Phone: 303-675-2175 or 800-344-3860 Toll Free USA/Canada
Fax: 303-675-2176 or 800-344-3867 Toll Free USA/Canada
Email: orderlit@onsemi.com

N. American Technical Support: 800-282-9855 Toll Free
USA/Canada
Europe, Middle East and Africa Technical Support:
Phone: 421 33 790 2910
Japan Customer Focus Center
Phone: 81-3-5773-3850

ON Semiconductor Website: www.onsemi.com

Order Literature: <http://www.onsemi.com/orderlit>

For additional information, please contact your local Sales Representative

Looking for pricing, stock, or lifecycle information?

Click below to explore more details on WIN SOURCE:

 [View CAT8900D250TBGT3 on WIN SOURCE](#)

 [ON Semiconductor](#) Information

Optimize Your Supply Chain with WIN SOURCE Solutions

-  Global Sourcing Solution
-  Obsolete Management
-  Cost Control Management
-  Shortage Management
-  Alternative Solution
-  Excess Inventory Management