



**THE DATASHEET OF  
BH1680FVC-TR**



STRUCTURE Silicon Monolithic Integrated Circuit

PRODUCT SERIES Analog Output Ambient Light Sensor IC

TYPE **BH1680FVC**

- FUNCTION
1. Compact surface mount package 1.6 × 1.6 mm
  2. Output current in proportion to brightness
  3. Suitable for optical window that the visible light transmission is low(High sensitivity type)
  4. The influence of infrared is very small by an infrared cut filter
  5. Supply voltage operates from 2.4V to 5.5V
  6. Built-in shutdown function
  7. 3 steps controllable output current gain
  8. 1.8V logic input interface
  9. Low sensitivity variation (+/-15%)

●Absolute Maximum Ratings ( Ta = 25°C )

Parameter	Symbol	Limits	Units
Supply Voltage	Vmax	7	V
Operating Temperature	Topr	-40~85	°C
Storage Temperature	Tstg	-40~100	°C
Iout Current	Ioutmax	7.5	mA
Power Dissipation	Pd	165※	mW

※ 70mm × 70mm × 1.6mm glass epoxy board. Derating in done at 2.2mW/°C for operating above Ta=25°C.

●Operating Conditions

Parameter	Symbol	Min.	Typ.	Max.	Units
VCC Voltage	Vcc	2.4	3.0	5.5	V

NOTE: This product is not designed for protection against radioactive rays.

This product does not include laser transmitter. This product does not include optical load.

This product includes Photo detector, ( Photo Diode ) inside of it.

·Status of this document

The Japanese version of this document is the formal specification. A customer may use this translation version only for a reference to help reading the formal version. If there are any differences in translation version of this document, formal version takes priority.

Application example

- ROHM cannot provide adequate confirmation of patents.
- The product described in this specification is designed to be used with ordinary electronic equipment or devices (such as audio-visual equipment, office-automation equipment, communications devices, electrical appliances, and electronic toys). Should you intend to use this product with equipment or devices which require an extremely high level of reliability and the malfunction of which would directly endanger human life (such as medical instruments, transportation equipment, aerospace machinery, nuclear-reactor controllers, fuel controllers and other safety devices), please be sure to consult with our sales representative in advance.
- ROHM assumes no responsibility for the use of any circuits described herein, conveys no license under any patent or other right, and makes no representations that the circuits are free from patent infringement.

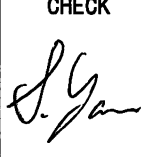
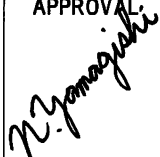
DESIGN 	CHECK 	APPROVAL 	DATE : Jul./28/2011	SPECIFICATION No. : TSZ02201-BH1680FVC-1-2
			REV. A	<b>ROHM Co.,Ltd.</b>

●Electrical Characteristics (  $V_{cc} = 3.0V$ ,  $T_a = 25^{\circ}C$ , unless otherwise noted )

Parameter	Symbol	Min.	Typ.	Max.	Units	Conditions
Supply Current1 ( Operate )	I <sub>cc1</sub>	51.9	75	105	μA	Ev=10 lx (H-Gain Mode)*
Supply Current2 ( 0 lx )	I <sub>cc2</sub>	4.5	9	13.5	μA	Ev=0 lx (H-Gain Mode)
Supply Current3 ( Shutdown )	I <sub>cc3sd</sub>	-	0.2	0.4	μA	V <sub>GC1</sub> =V <sub>GC2</sub> =0 No Input Light
IOUT Output Current1(Dark Current)	I <sub>out1</sub>	-	-	0.2	μA	Ev=0 lx
IOUT Output Current2	I <sub>out2</sub>	51.9	61	70.1	μA	Ev=10 lx (H-Gain Mode)*
Saturated Output Voltage	V <sub>OMAX</sub>	2.6	2.9	3.0	V	Ev=10 lx, R <sub>L</sub> =220kΩ (H-Gain Mode)*
GC1,GC2 Input 'L' Voltage	V <sub>IL</sub>	0	-	0.4	V	
GC1,GC2 Input 'H' Voltage1	V <sub>IH1</sub>	1.4	-	V <sub>cc</sub>	V	2.4V ≤ V <sub>cc</sub> ≤ 3.6V
GC1,GC2 Input 'H' Voltage2	V <sub>IH2</sub>	2.0	-	V <sub>cc</sub>	V	3.6V < V <sub>cc</sub> ≤ 5.5V
Wake-up Time	t <sub>wu</sub>	-	13	52	μs	Shutdown→H-Gain Mode Ev=100lx*
Gain Ratio H-Gain Mode/M-Gain Mode	r <sub>HM</sub>	8	10	12	times	Ev=10lx*
Gain Ratio M-Gain Mode/L-Gain Mode	r <sub>ML</sub>	8	10	12	times	Ev=10lx*

\*White LED is used as optical source

●Package Outlines

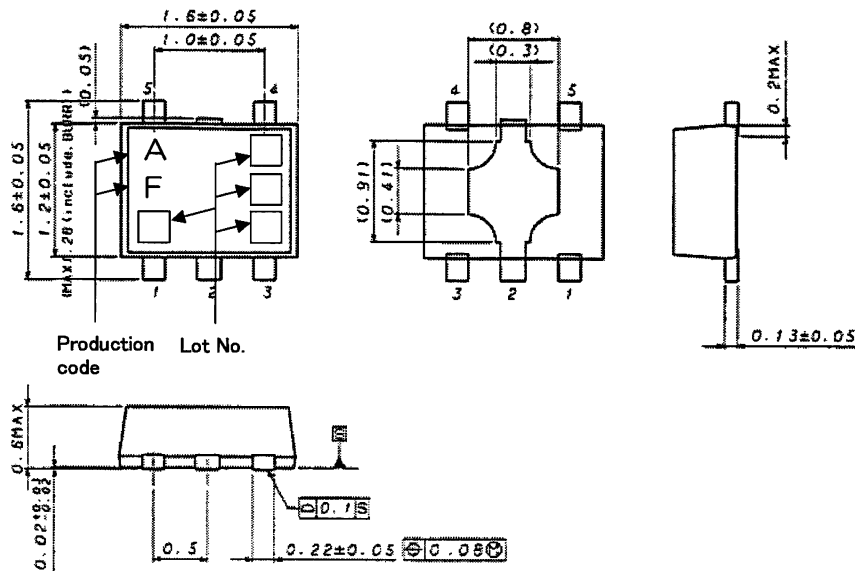

WSOF5 ( Unit : mm )

● Terminal Description

Pin No.	Pin Name	Function
1	VCC	Power supply voltage terminal
2	GND	Ground terminal
3	GC1	Mode Setting Pin 1
4	GC2	Mode Setting Pin 2
5	IOUT	Output current which is proportionate to the light. Use this pin putting resistor between GND.

● Block Diagram

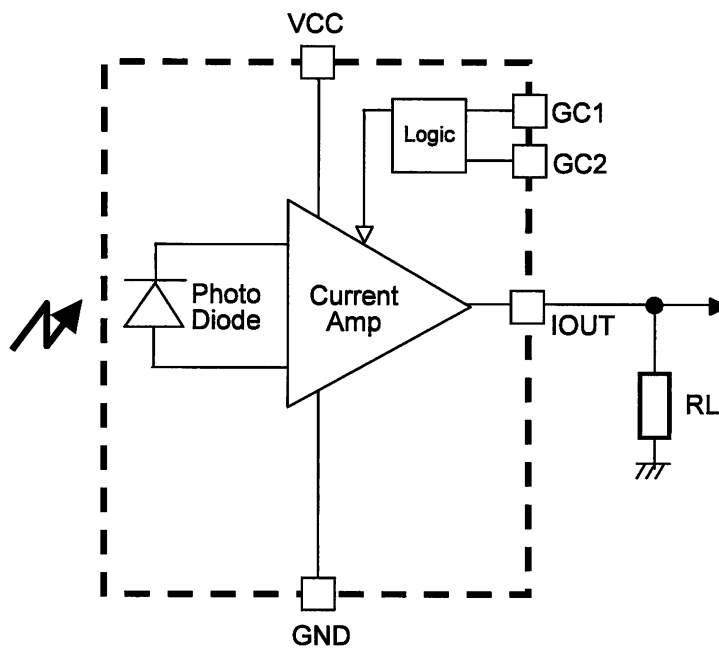

● Mode Setting

GC2	GC1	Mode
0	0	Shutdown
0	1	H-Gain Mode
1	0	M-Gain Mode
1	1	L-Gain Mode

## ●Cautions on use

## 1) Absolute Maximum Ratings

An excess in the absolute maximum ratings, such as supply voltage (  $V_{max}$  ), temperature range of operating conditions (  $T_{opr}$  ), etc., can break down devices, thus making impossible to identify breaking mode such as a short circuit or an open circuit. If any special mode exceeding the absolute maximum ratings is assumed, consideration should be given to take physical safety measures including the use of fuses, etc.

## 2) GND voltage

Make setting of the potential of the GND terminal so that it will be maintained at the minimum in any operating state. Furthermore, check to be sure no terminals are at a potential lower than the GND voltage including an actual electric transient.

## 3) Short circuit between terminals and erroneous mounting

In order to mount ICs on a set PCB, pay thorough attention to the direction and offset of the ICs. Erroneous mounting can break down the ICs. Furthermore, if a short circuit occurs due to foreign matters entering between terminals or between the terminal and the power supply or the GND terminal, the ICs can break down.

## 4) Operation in strong electromagnetic field

Be noted that using ICs in the strong electromagnetic field can malfunction them.

## 5) Inspection with set PCB

On the inspection with the set PCB, if a capacitor is connected to a low-impedance IC terminal, the IC can suffer stress. Therefore, be sure to discharge from the set PCB by each process. Furthermore, in order to mount or dismount the set PCB to/from the jig for the inspection process, be sure to turn OFF the power supply and then mount the set PCB to the jig. After the completion of the inspection, be sure to turn OFF the power supply and then dismount it from the jig. In addition, for protection against static electricity, establish a ground for the assembly process and pay thorough attention to the transportation and the storage of the set PCB.

## 6) Input terminals

In terms of the construction of IC, parasitic elements are inevitably formed in relation to potential. The operation of the parasitic element can cause interference with circuit operation, thus resulting in a malfunction and then breakdown of the input terminal. Therefore, pay thorough attention not to handle the input terminals; such as to apply to the input terminals a voltage lower than the GND respectively, so that any parasitic element will operate. Furthermore, do not apply a voltage to the input terminals when no power supply voltage is applied to the IC. In addition, even if the power supply voltage is applied, apply to the input terminals a voltage lower than the power supply voltage or within the guaranteed value of electrical characteristics.

## 7) Thermal design

Perform thermal design in which there are adequate margins by taking into account the power dissipation (  $P_d$  ) in actual states of use.

## 8) Treatment of package

Dusts or scratch on the photo detector may affect the optical characteristics. Please handle it with care.

## 9) When power is first supplied to this IC, rush current may flow instantaneously. Because it is possible that the charge current to the parasitic capacitance of internal photo diode or the internal logic may be unstable. Therefore, give special consideration to power coupling capacitance, power wiring, width of GND wiring, and routing of connections.

## 10) The exposed central pad on the back side of the package

There is an exposed central pad on the back side of the package. Please mount by footprint dimensions described in the Jisso Information for WSO5. This pad is GND pin, therefore there is a possibility that LSI malfunctions and heavy-current is generated.

# Notice

## Precaution on using ROHM Products

- Our Products are designed and manufactured for application in ordinary electronic equipment (such as AV equipment, OA equipment, telecommunication equipment, home electronic appliances, amusement equipment, etc.). If you intend to use our Products in devices requiring extremely high reliability (such as medical equipment <sup>(Note 1)</sup>, transport equipment, traffic equipment, aircraft/spacecraft, nuclear power controllers, fuel controllers, car equipment including car accessories, safety devices, etc.) and whose malfunction or failure may cause loss of human life, bodily injury or serious damage to property ("Specific Applications"), please consult with the ROHM sales representative in advance. Unless otherwise agreed in writing by ROHM in advance, ROHM shall not be in any way responsible or liable for any damages, expenses or losses incurred by you or third parties arising from the use of any ROHM's Products for Specific Applications.

(Note1) Medical Equipment Classification of the Specific Applications

JAPAN	USA	EU	CHINA
CLASS III	CLASS III	CLASS II b	CLASS III
CLASS IV		CLASS III	

- ROHM designs and manufactures its Products subject to strict quality control system. However, semiconductor products can fail or malfunction at a certain rate. Please be sure to implement, at your own responsibilities, adequate safety measures including but not limited to fail-safe design against the physical injury, damage to any property, which a failure or malfunction of our Products may cause. The following are examples of safety measures:
  - Installation of protection circuits or other protective devices to improve system safety
  - Installation of redundant circuits to reduce the impact of single or multiple circuit failure
- Our Products are designed and manufactured for use under standard conditions and not under any special or extraordinary environments or conditions, as exemplified below. Accordingly, ROHM shall not be in any way responsible or liable for any damages, expenses or losses arising from the use of any ROHM's Products under any special or extraordinary environments or conditions. If you intend to use our Products under any special or extraordinary environments or conditions (as exemplified below), your independent verification and confirmation of product performance, reliability, etc. prior to use, must be necessary:
  - Use of our Products in any types of liquid, including water, oils, chemicals, and organic solvents
  - Use of our Products outdoors or in places where the Products are exposed to direct sunlight or dust
  - Use of our Products in places where the Products are exposed to sea wind or corrosive gases, including Cl<sub>2</sub>, H<sub>2</sub>S, NH<sub>3</sub>, SO<sub>2</sub>, and NO<sub>2</sub>
  - Use of our Products in places where the Products are exposed to static electricity or electromagnetic waves
  - Use of our Products in proximity to heat-producing components, plastic cords, or other flammable items
  - Sealing or coating our Products with resin or other coating materials
  - Use of our Products without cleaning residue of flux (Exclude cases where no-clean type fluxes is used. However, recommend sufficiently about the residue.) ; or Washing our Products by using water or water-soluble cleaning agents for cleaning residue after soldering
  - Use of the Products in places subject to dew condensation
- The Products are not subject to radiation-proof design.
- Please verify and confirm characteristics of the final or mounted products in using the Products.
- In particular, if a transient load (a large amount of load applied in a short period of time, such as pulse. is applied, confirmation of performance characteristics after on-board mounting is strongly recommended. Avoid applying power exceeding normal rated power; exceeding the power rating under steady-state loading condition may negatively affect product performance and reliability.
- De-rate Power Dissipation depending on ambient temperature. When used in sealed area, confirm that it is the use in the range that does not exceed the maximum junction temperature.
- Confirm that operation temperature is within the specified range described in the product specification.
- ROHM shall not be in any way responsible or liable for failure induced under deviant condition from what is defined in this document.

## Precaution for Mounting / Circuit board design

- When a highly active halogenous (chlorine, bromine, etc.) flux is used, the residue of flux may negatively affect product performance and reliability.
- In principle, the reflow soldering method must be used on a surface-mount products, the flow soldering method must be used on a through hole mount products. If the flow soldering method is preferred on a surface-mount products, please consult with the ROHM representative in advance.

For details, please refer to ROHM Mounting specification

### Precautions Regarding Application Examples and External Circuits

1. If change is made to the constant of an external circuit, please allow a sufficient margin considering variations of the characteristics of the Products and external components, including transient characteristics, as well as static characteristics.
2. You agree that application notes, reference designs, and associated data and information contained in this document are presented only as guidance for Products use. Therefore, in case you use such information, you are solely responsible for it and you must exercise your own independent verification and judgment in the use of such information contained in this document. ROHM shall not be in any way responsible or liable for any damages, expenses or losses incurred by you or third parties arising from the use of such information.

### Precaution for Electrostatic

This Product is electrostatic sensitive product, which may be damaged due to electrostatic discharge. Please take proper caution in your manufacturing process and storage so that voltage exceeding the Products maximum rating will not be applied to Products. Please take special care under dry condition (e.g. Grounding of human body / equipment / solder iron, isolation from charged objects, setting of Ionizer, friction prevention and temperature / humidity control).

### Precaution for Storage / Transportation

1. Product performance and soldered connections may deteriorate if the Products are stored in the places where:
  - [a] the Products are exposed to sea winds or corrosive gases, including Cl<sub>2</sub>, H<sub>2</sub>S, NH<sub>3</sub>, SO<sub>2</sub>, and NO<sub>2</sub>
  - [b] the temperature or humidity exceeds those recommended by ROHM
  - [c] the Products are exposed to direct sunshine or condensation
  - [d] the Products are exposed to high Electrostatic
2. Even under ROHM recommended storage condition, solderability of products out of recommended storage time period may be degraded. It is strongly recommended to confirm solderability before using Products of which storage time is exceeding the recommended storage time period.
3. Store / transport cartons in the correct direction, which is indicated on a carton with a symbol. Otherwise bent leads may occur due to excessive stress applied when dropping of a carton.
4. Use Products within the specified time after opening a humidity barrier bag. Baking is required before using Products of which storage time is exceeding the recommended storage time period.

### Precaution for Product Label

A two-dimensional barcode printed on ROHM Products label is for ROHM's internal use only.

### Precaution for Disposition

When disposing Products please dispose them properly using an authorized industry waste company.

### Precaution for Foreign Exchange and Foreign Trade act

Since concerned goods might be fallen under listed items of export control prescribed by Foreign exchange and Foreign trade act, please consult with ROHM in case of export.

### Precaution Regarding Intellectual Property Rights

1. All information and data including but not limited to application example contained in this document is for reference only. ROHM does not warrant that foregoing information or data will not infringe any intellectual property rights or any other rights of any third party regarding such information or data.
2. ROHM shall not have any obligations where the claims, actions or demands arising from the combination of the Products with other articles such as components, circuits, systems or external equipment (including software).
3. No license, expressly or implied, is granted hereby under any intellectual property rights or other rights of ROHM or any third parties with respect to the Products or the information contained in this document. Provided, however, that ROHM will not assert its intellectual property rights or other rights against you or your customers to the extent necessary to manufacture or sell products containing the Products, subject to the terms and conditions herein.

### Other Precaution

1. This document may not be reprinted or reproduced, in whole or in part, without prior written consent of ROHM.
2. The Products may not be disassembled, converted, modified, reproduced or otherwise changed without prior written consent of ROHM.
3. In no event shall you use in any way whatsoever the Products and the related technical information contained in the Products or this document for any military purposes, including but not limited to, the development of mass-destruction weapons.
4. The proper names of companies or products described in this document are trademarks or registered trademarks of ROHM, its affiliated companies or third parties.

**General Precaution**



1. Before you use our Products, you are requested to carefully read this document and fully understand its contents. ROHM shall not be in any way responsible or liable for failure, malfunction or accident arising from the use of any ROHM's Products against warning, caution or note contained in this document.
2. All information contained in this document is current as of the issuing date and subject to change without any prior notice. Before purchasing or using ROHM's Products, please confirm the latest information with a ROHM sales representative.
3. The information contained in this document is provided on an "as is" basis and ROHM does not warrant that all information contained in this document is accurate and/or error-free. ROHM shall not be in any way responsible or liable for any damages, expenses or losses incurred by you or third parties resulting from inaccuracy or errors of or concerning such information.

## Looking for pricing, stock, or lifecycle information?

Click below to explore more details on WIN SOURCE:

-  [View BH1680FVC-TR on WIN SOURCE](#)
-  [Rohm Semiconductor](#) Information

## Optimize Your Supply Chain with WIN SOURCE Solutions

-  Global Sourcing Solution
-  Obsolete Management
-  Cost Control Management
-  Shortage Management
-  Alternative Solution
-  Excess Inventory Management