



**THE DATASHEET OF  
MC33079YDT**



## Low noise quad operational amplifier

Datasheet – production data

### Features

- Low voltage noise: 4.5 nV/ $\sqrt{\text{Hz}}$
- High gain bandwidth product: 15 MHz
- High slew rate: 7 V/ $\mu\text{s}$
- Low distortion: 0.002%
- Large output voltage swing: +14.3 V/-14.6 V
- Excellent frequency stability
- ESD protection 2 kV

### Description

The MC33079 device is a monolithic quad operational amplifier particularly well suited for audio applications.

It offers low voltage noise (4.5 nV/ $\sqrt{\text{Hz}}$ ) and high frequency performance (15 MHz gain bandwidth product, 7 V/ $\mu\text{s}$  slew rate).

In addition the MC33079 device has a very low distortion (0.002%) and excellent phase/gain margins.

The output stage allows a large output voltage swing and symmetrical source and sink currents.

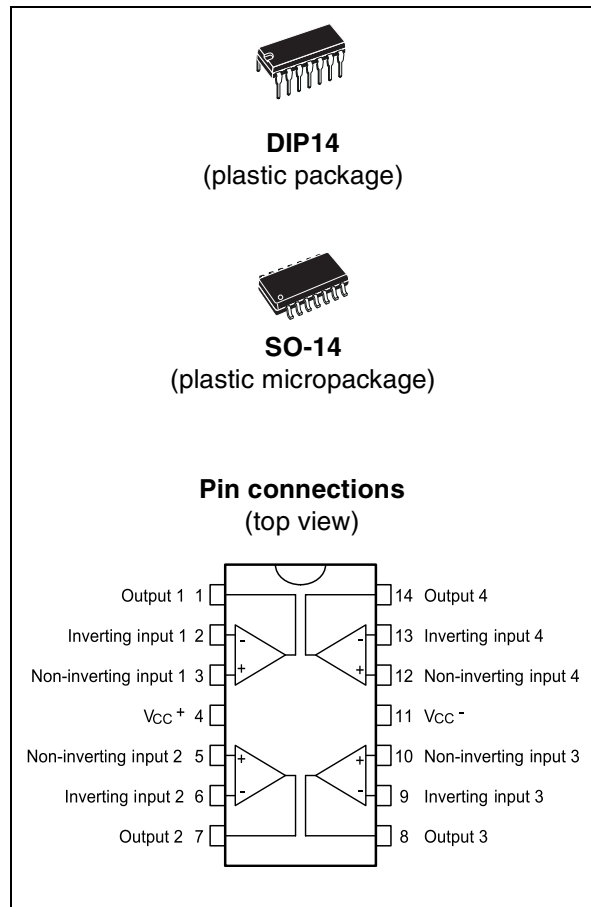

# 1 Schematic diagram (1/4 MC33079)

Figure 1. Schematic diagram (1/4 MC33079)

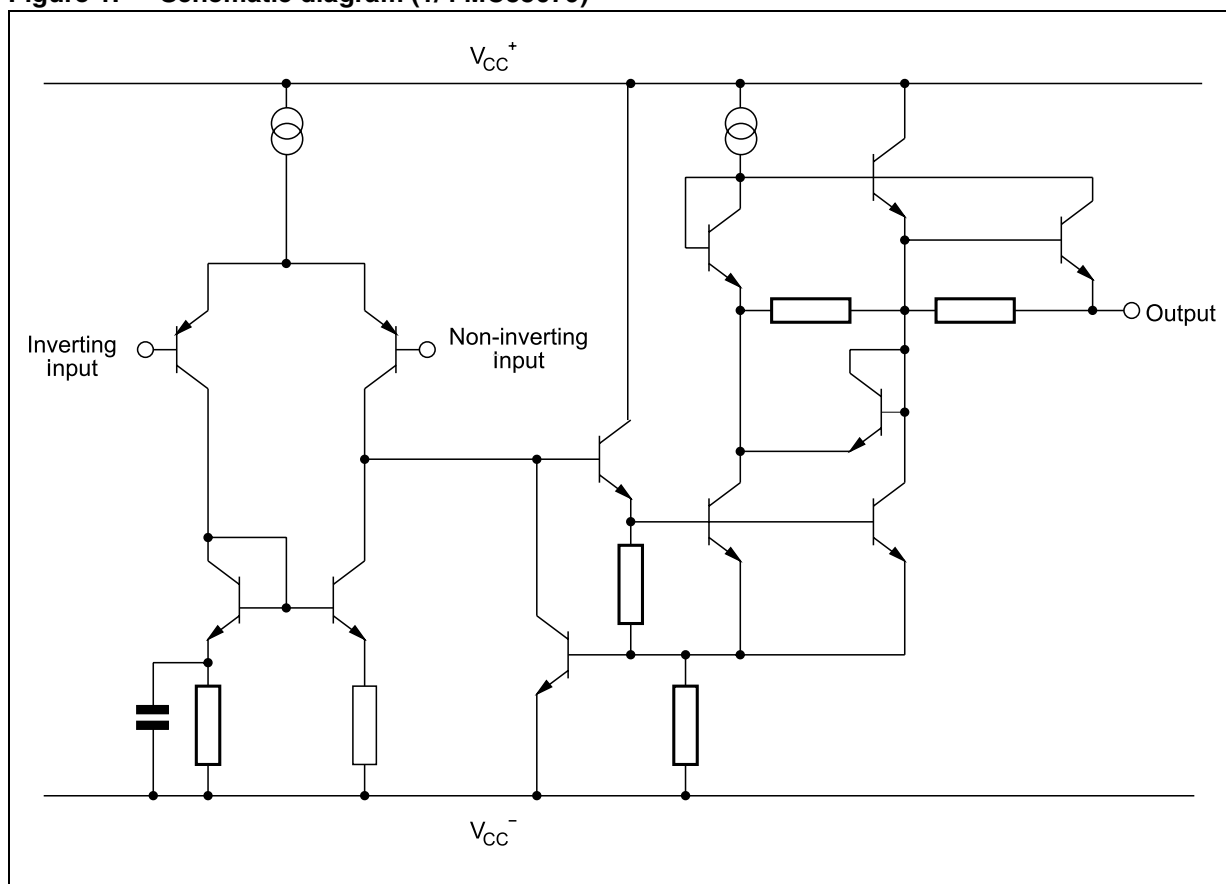

## 2 Absolute maximum ratings and operating conditions

**Table 1. Absolute maximum ratings (AMR)**

Symbol	Parameter	Value	Unit
$V_{CC}$	Supply voltage	$\pm 18$ or $+36$	V
$V_{id}$	Differential input voltage <sup>(1)</sup>	$\pm 30$	V
$V_i$	Input voltage <sup>(1)</sup>	$\pm 15$	V
	Output short-circuit duration	Infinite	s
$T_j$	Junction temperature	+150	°C
$T_{stg}$	Storage temperature	-65 to +150	°C
$R_{thja}$	Thermal resistance junction-to-ambient <sup>(2), (3)</sup>		°C/W
	DIP14 SO-14	80 105	
$R_{thjc}$	Thermal resistance junction-to-case <sup>(2), (3)</sup>		°C/W
	DIP14 SO-14	33 31	
ESD	HBM: human body model <sup>(4)</sup>	2	kV
	MM: machine model <sup>(5)</sup>	200	V
	CDM: charged device model <sup>(6)</sup>	1.5	kV

1. Either or both input voltages must not exceed the magnitude of  $V_{CC}^+$  or  $V_{CC}^-$ .
2. Short-circuits can cause excessive heating. Destructive dissipation can result from simultaneous short-circuits on all amplifiers.
3.  $R_{th}$  are typical values.
4. Human body model: 100 pF discharged through a 1.5 k $\Omega$  resistor between two pins of the device, done for all couples of pin combinations with other pins floating.
5. Machine model: a 200 pF cap is charged to the specified voltage, then discharged directly between two pins of the device with no external series resistor (internal resistor < 5  $\Omega$ ), done for all couples of pin combinations with other pins floating.
6. Charged device model: all pins plus package are charged together to the specified voltage and then discharged directly to ground.

**Table 2. Operating conditions**

Symbol	Parameter	Value	Unit
$V_{CC}$	Supply voltage	$\pm 2.5$ to $\pm 15$	V
$T_{oper}$	Operating free air temperature range	-40 to 125	°C
$V_{icm}$	Input common mode voltage range ( $\Delta V_{io}/\Delta T = 5$ mV, $V_o = 0$ V)	$\pm 13$ to $\pm 14$	V

### 3 Electrical characteristics

**Table 3. Electrical characteristics at  $V_{CC}^+ = +15\text{ V}$ ,  $V_{CC}^- = -15\text{ V}$ ,  $T_{amb} = 25\text{ }^\circ\text{C}$  (unless otherwise specified)**

Symbol	Parameter	Min.	Typ.	Max.	Unit
$V_{io}$	Input offset voltage ( $V_o = 0\text{ V}$ , $V_{ic} = 0\text{ V}$ ) $T_{min} \leq T_{amb} \leq T_{max}$			2.5 3.5	mV
$\Delta V_{io}/\Delta T$	Input offset voltage drift $V_o = 0\text{ V}$ , $V_{ic} = 0\text{ V}$ , $T_{min} \leq T_{amb} \leq T_{max}$		2		$\mu\text{V}/^\circ\text{C}$
$I_{io}$	Input offset current ( $V_o = 0\text{ V}$ , $V_{ic} = 0\text{ V}$ ) $T_{min} \leq T_{amb} \leq T_{max}$		10	150 175	nA
$I_{ib}$	Input bias current ( $V_o = 0\text{ V}$ , $V_{ic} = 0\text{ V}$ ) $T_{min} \leq T_{amb} \leq T_{max}$		250	750 800	nA
$A_{vd}$	Large signal voltage gain ( $R_L = 2\text{ k}\Omega$ , $V_o = \pm 10\text{ V}$ ) $T_{min} \leq T_{amb} \leq T_{max}$	90 85	100		dB
$\pm V_{opp}$	Output voltage swing ( $V_{id} = \pm 1\text{ V}$ ) $R_L = 600\ \Omega$ $R_L = 600\ \Omega$ $R_L = 2.0\text{ k}\Omega$ $R_L = 2.0\text{ k}\Omega$ $R_L = 10\text{ k}\Omega$ $R_L = 10\text{ k}\Omega$	13.2 13.5	12.2 -12.7 14 -14.2 14.3 -14.6	-13.2 -14	V
CMR	Common-mode rejection ratio ( $V_{ic} = \pm 13\text{ V}$ )	80	100		dB
SVR	Supply voltage rejection ratio ( $V_{CC}^+ / V_{CC}^- = +15\text{ V} / -15\text{ V}$ to $+5\text{ V} / -5\text{ V}$ )	80	105		dB
$I_o$	Output short-circuit current ( $V_{id} = \pm 1\text{ V}$ , output to ground) Source Sink	15 20	29 37		mA
$I_{CC}$	Supply current ( $V_o = 0\text{ V}$ , all amplifiers) $T_{min} \leq T_{amb} \leq T_{max}$		8	10 12	mA
SR	Slew rate ( $V_i = -10\text{ V}$ to $+10\text{ V}$ , $R_L = 2\text{ k}\Omega$ , $C_L = 100\text{ pF}$ , $A_V = +1$ )	5	7		V/ $\mu\text{s}$
GBP	Gain bandwidth product ( $R_L = 2\text{ k}\Omega$ , $C_L = 100\text{ pF}$ , $f = 100\text{ kHz}$ )	10	15		MHz
B	Unity gain bandwidth (open loop)		9		MHz
$A_m$	Gain margin ( $R_L = 2\text{ k}\Omega$ ) $C_L = 0\text{ pF}$ $C_L = 100\text{ pF}$		-11 -6		dB
$\phi_m$	Phase margin ( $R_L = 2\text{ k}\Omega$ ) $C_L = 0\text{ pF}$ $C_L = 100\text{ pF}$		55 30		Degrees
$e_n$	Equivalent input noise voltage ( $R_S = 100\ \Omega$ , $f = 1\text{ kHz}$ )		4.5		$\frac{\text{nV}}{\sqrt{\text{Hz}}}$
$i_n$	Equivalent input noise current ( $f = 1\text{ kHz}$ )		0.5		$\frac{\text{pA}}{\sqrt{\text{Hz}}}$

**Table 3. Electrical characteristics at  $V_{CC}^+ = +15\text{ V}$ ,  $V_{CC}^- = -15\text{ V}$ ,  $T_{amb} = 25\text{ °C}$   
(unless otherwise specified) (continued)**

Symbol	Parameter	Min.	Typ.	Max.	Unit
THD	Total harmonic distortion ( $R_L = 2\text{ k}\Omega$ , $f = 20\text{ Hz to } 20\text{ kHz}$ , $V_o = 3\text{ V}_{rms}$ , $A_V = +1$ )		0.002		%
$V_{O1}/V_{O2}$	Channel separation ( $f = 20\text{ Hz to } 20\text{ kHz}$ )		120		dB
FPB	Full power bandwidth ( $V_o = 27\text{ V}_{pp}$ , $R_L = 2\text{ k}\Omega$ , $THD \leq 1\%$ )		120		kHz
$Z_o$	Output impedance ( $V_o = 0\text{ V}$ , $f = 9\text{ MHz}$ )		37		$\Omega$
$R_i$	Input resistance ( $V_{ic} = 0\text{ V}$ )		175		k $\Omega$
$C_i$	Input capacitance ( $V_{ic} = 0\text{ V}$ )		12		pF

Figure 2. Supply current vs. supply voltage

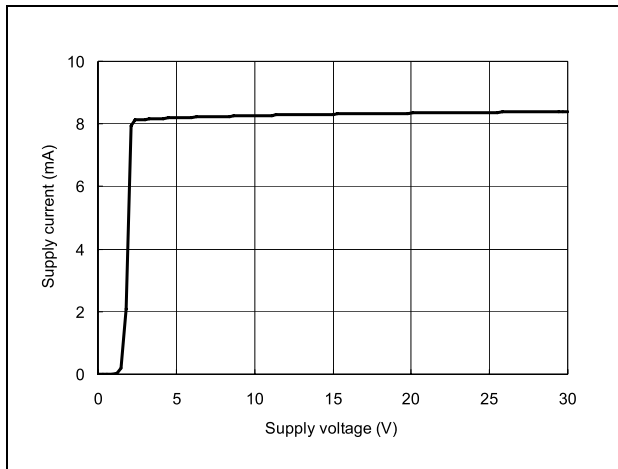

Figure 3. Output voltage vs. supply voltage ( $V_{id} = \pm 1\text{ V}$ ,  $R_L = 600\ \Omega$ )

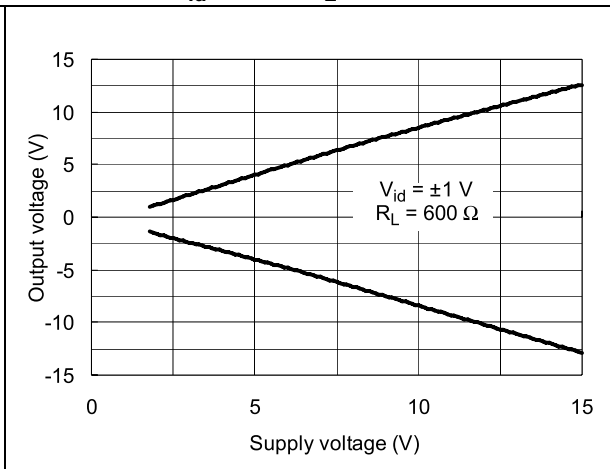

Figure 4. Equivalent input noise voltage vs. frequency

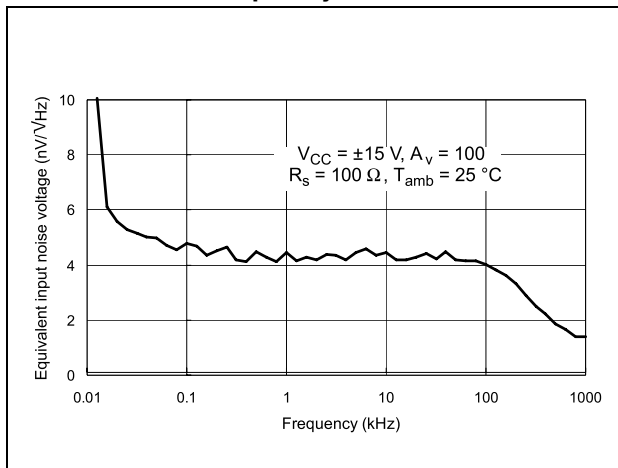

Figure 5. Output short-circuit current vs. output voltage

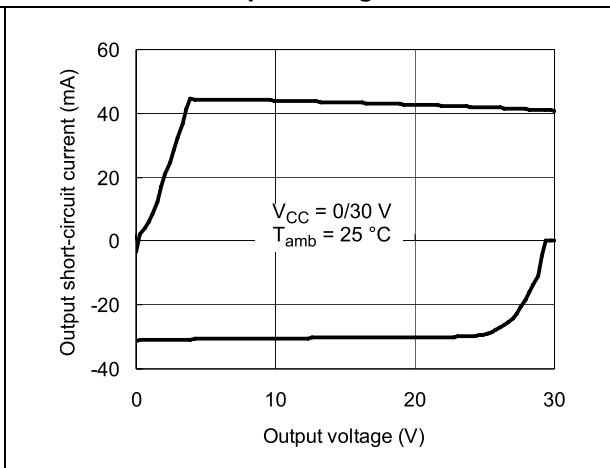

Figure 6. Output voltage vs. supply voltage ( $V_{id} = \pm 1\text{ V}$ ,  $R_L = 2\text{ k}\Omega$ )

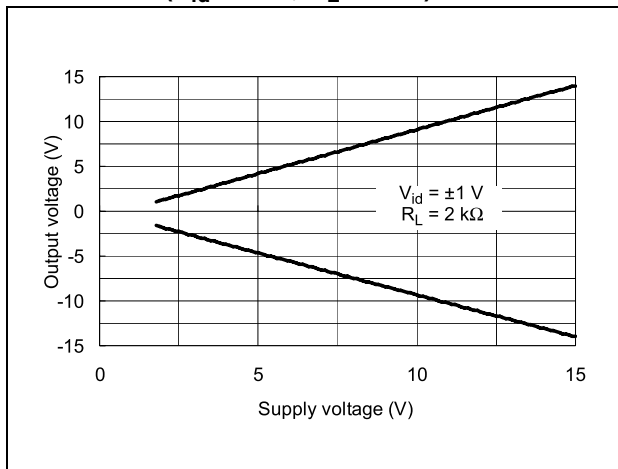

Figure 7. THD + noise vs. frequency

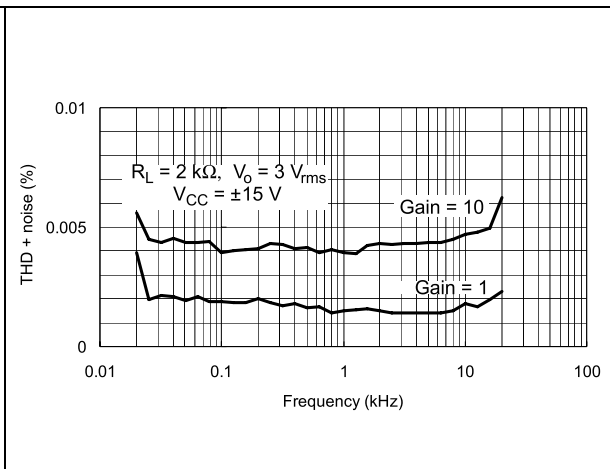

Figure 8. Voltage gain and phase vs. frequency

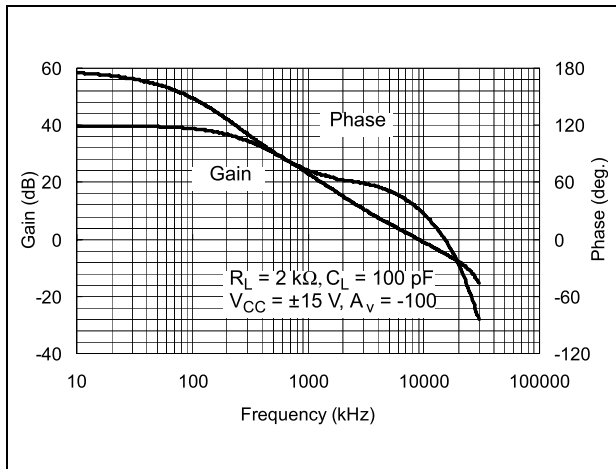
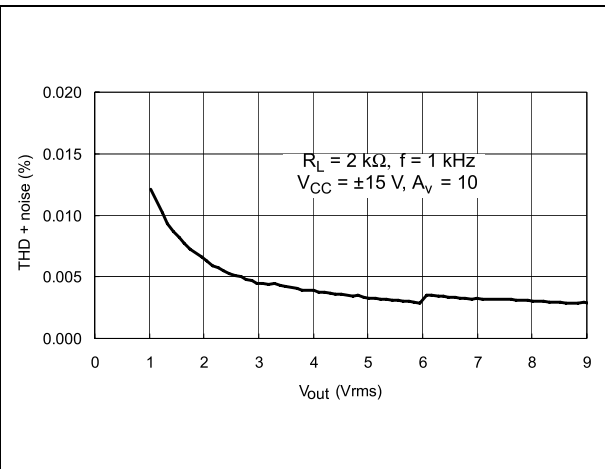

Figure 9. Total harmonic distortion vs. output voltage



## 4 Package information

In order to meet environmental requirements, ST offers these devices in different grades of ECOPACK® packages, depending on their level of environmental compliance. ECOPACK specifications, grade definitions and product status are available at: [www.st.com](http://www.st.com). ECOPACK is an ST trademark.

### 4.1 DIP14 package information

Figure 10. DIP14 package outline

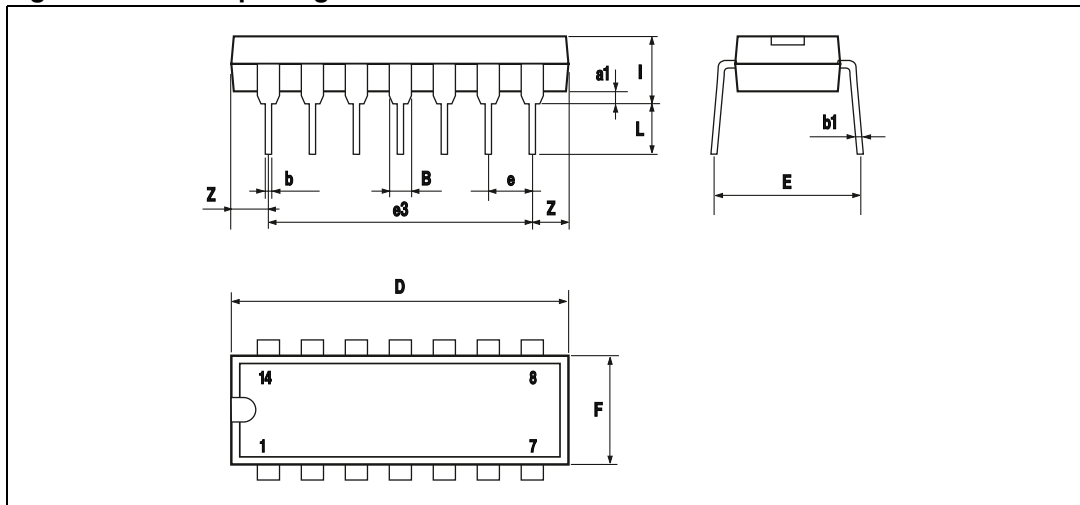

Table 4. DIP14 package mechanical data

Symbol	Dimensions					
	Millimeters			Inches		
	Min.	Typ.	Max.	Min.	Typ.	Max.
a1	0.51			0.020		
B	1.39		1.65	0.055		0.065
b		0.5			0.020	
b1		0.25			0.010	
D			20			0.787
E		8.5			0.335	
e		2.54			0.100	
e3		15.24			0.600	
F			7.1			0.280
l			5.1			0.201
L		3.3			0.130	
Z	1.27		2.54	0.050		0.100

## 4.2 SO-14 package information

Figure 11. SO-14 package outline

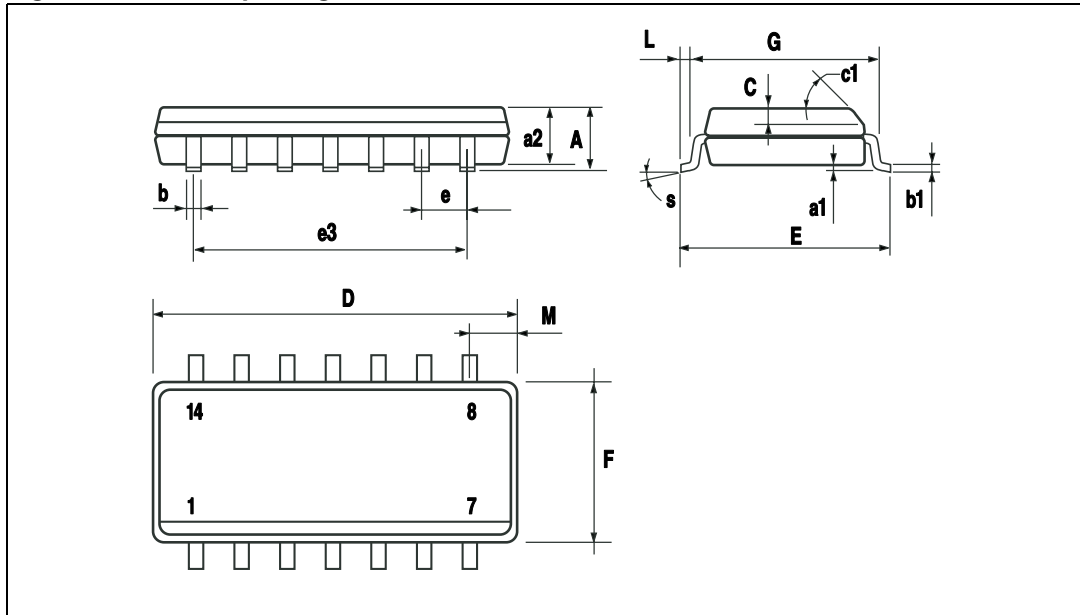

Table 5. SO-14 package mechanical data

Symbol	Dimensions					
	Millimeters			Inches		
	Min.	Typ.	Max.	Min.	Typ.	Max.
A			1.75			0.068
a1	0.1		0.2	0.003		0.007
a2			1.65			0.064
b	0.35		0.46	0.013		0.018
b1	0.19		0.25	0.007		0.010
C		0.5			0.019	
c1	45° (typ.)					
D	8.55		8.75	0.336		0.344
E	5.8		6.2	0.228		0.244
e		1.27			0.050	
e3		7.62			0.300	
F	3.8		4.0	0.149		0.157
G	4.6		5.3	0.181		0.208
L	0.5		1.27	0.019		0.050
M			0.68			0.026
S	8° (max.)					

## 5 Ordering information

**Table 6. Order codes**

Order code	Temperature range	Package	Packaging	Marking
MC33079N	-40 °C to +125 °C	DIP14	Tube	MC33079N
MC33079D MC33079DT		SO-14	Tube or tape and reel	33079
MC33079YDT <sup>(1)</sup>		SO-14 (automotive grade)	Tube or tape and reel	33079Y

1. Qualified and characterized according to AEC Q100 and Q003 or equivalent, advanced screening according to AEC Q001 and Q 002 or equivalent.

## 6 Revision history

**Table 7. Document revision history**

Date	Revision	Changes
10-Oct-2001	1	Initial release.
23-Jun-2005	2	PPAP references inserted in the datasheet. See order codes table.
21-Nov-2007	3	Added $R_{thja}$ , $R_{thjc}$ and ESD values in <a href="#">Table 1: Absolute maximum ratings (AMR)</a> . Added footnote for automotive grade order codes in order codes table. Updated document format.
13-Mar-2008	4	Corrected value for ESD HBM parameter. Removed section on Macromodel.
14-Nov-2012	5	Updated <a href="#">Features</a> (removed “macromodel”). Updated title of <a href="#">Figure 3</a> and <a href="#">Figure 6</a> (added conditions). Updated ECOPACK text in <a href="#">Section 4</a> . Updated temperature range to 125 °C in <a href="#">Table 2</a> and <a href="#">Table 6</a> . Updated MC33079YDT order code (status qualified), removed MC33079YD order code from <a href="#">Table 6</a> . Minor corrections throughout document.

**Please Read Carefully:**

Information in this document is provided solely in connection with ST products. STMicroelectronics NV and its subsidiaries ("ST") reserve the right to make changes, corrections, modifications or improvements, to this document, and the products and services described herein at any time, without notice.

All ST products are sold pursuant to ST's terms and conditions of sale.

Purchasers are solely responsible for the choice, selection and use of the ST products and services described herein, and ST assumes no liability whatsoever relating to the choice, selection or use of the ST products and services described herein.

No license, express or implied, by estoppel or otherwise, to any intellectual property rights is granted under this document. If any part of this document refers to any third party products or services it shall not be deemed a license grant by ST for the use of such third party products or services, or any intellectual property contained therein or considered as a warranty covering the use in any manner whatsoever of such third party products or services or any intellectual property contained therein.

**UNLESS OTHERWISE SET FORTH IN ST'S TERMS AND CONDITIONS OF SALE ST DISCLAIMS ANY EXPRESS OR IMPLIED WARRANTY WITH RESPECT TO THE USE AND/OR SALE OF ST PRODUCTS INCLUDING WITHOUT LIMITATION IMPLIED WARRANTIES OF MERCHANTABILITY, FITNESS FOR A PARTICULAR PURPOSE (AND THEIR EQUIVALENTS UNDER THE LAWS OF ANY JURISDICTION), OR INFRINGEMENT OF ANY PATENT, COPYRIGHT OR OTHER INTELLECTUAL PROPERTY RIGHT.**

**UNLESS EXPRESSLY APPROVED IN WRITING BY TWO AUTHORIZED ST REPRESENTATIVES, ST PRODUCTS ARE NOT RECOMMENDED, AUTHORIZED OR WARRANTED FOR USE IN MILITARY, AIR CRAFT, SPACE, LIFE SAVING, OR LIFE SUSTAINING APPLICATIONS, NOR IN PRODUCTS OR SYSTEMS WHERE FAILURE OR MALFUNCTION MAY RESULT IN PERSONAL INJURY, DEATH, OR SEVERE PROPERTY OR ENVIRONMENTAL DAMAGE. ST PRODUCTS WHICH ARE NOT SPECIFIED AS "AUTOMOTIVE GRADE" MAY ONLY BE USED IN AUTOMOTIVE APPLICATIONS AT USER'S OWN RISK.**

Resale of ST products with provisions different from the statements and/or technical features set forth in this document shall immediately void any warranty granted by ST for the ST product or service described herein and shall not create or extend in any manner whatsoever, any liability of ST.

ST and the ST logo are trademarks or registered trademarks of ST in various countries.

Information in this document supersedes and replaces all information previously supplied.

The ST logo is a registered trademark of STMicroelectronics. All other names are the property of their respective owners.

© 2012 STMicroelectronics - All rights reserved

STMicroelectronics group of companies



Australia - Belgium - Brazil - Canada - China - Czech Republic - Finland - France - Germany - Hong Kong - India - Israel - Italy - Japan - Malaysia - Malta - Morocco - Philippines - Singapore - Spain - Sweden - Switzerland - United Kingdom - United States of America

[www.st.com](http://www.st.com)



## Looking for pricing, stock, or lifecycle information?

Click below to explore more details on WIN SOURCE:

-  [View MC33079YDT](#) on WIN SOURCE
-  [STMicroelectronics](#) Information

## Optimize Your Supply Chain with WIN SOURCE Solutions

-  Global Sourcing Solution
-  Obsolete Management
-  Cost Control Management
-  Shortage Management
-  Alternative Solution
-  Excess Inventory Management