





**THE DATASHEET OF
BZT52C27**



SPECIFICATION SHEET

SPECIFICATION SHEET NO.	N0310-SOD123C270S0WP
DATE	Mar. 10, 2021
REVISION	A0
DESCRIPTION	SMD Zener Diodes, SOD-123 series, BZT52C27 Type, 2 Pads Zener Voltage 27.0 Volts Typical, Peak Pulse Power - 500 mW Operating Temp. Range -65°C ~+150°C Package in Tape/Reel, 3000pcs/Reel RoHS/RoHS III compliant
CUSTOMER	
CUSTOMER PART NUMBER	
CROSS REF. PART NUMBER	
ORIGINAL PART NUMBER	MDD BZT52C27
PART CODE	SOD123C270S0WP

VENDOR APPROVE			
Issued/Checked/Approved			
DATE: March 10, 2021			

CUSTOMER APPROVE	
DATE:	

SMD ZENER DIODES SOD-123 SERIES

MAIN FEATURE

- Total power dissipation: Max. 500mW.
- Wide zener reverse voltage range 2.0V to 75V.
- Small plastic package suitable for surface mounted design.
- Tolerance approximately $\pm 5\%$



APPLICATION

- For SMD application

RFQ

[Request For Quotation](#)

PART CODE GUIDE

SOD123	C270	S	OWP
1	2	3	4

- 1) **SOD123**: SMD Zener Diodes, SOD-123 series
- 2) **C270**: Type code for original part number BZT52C27
- 3) **S**: Package code, Tape/reel, 3000pcs/reel.
- 4) **OWP**: Marking code for “WP” on the case surface, Different Marking for different specification.

SMD ZENER DIODES SOD-123 SERIES

MORE ITEMS AVAILABLE

SOD123C2V0S0WY	SOD123C2V2S0WZ	SOD123C2V4S0WX		
SOD123C2V7S0W1	SOD123C3V0S0W2	SOD123C3V3S0W3	SOD123C3V6S0W4	SOD123C3V9S0W5
SOD123C4V3S0W6	SOD123C4V7S0W7	SOD123C5V1S0W8	SOD123C5V6S0W9	
SOD123C6V2S0WA	SOD123C6V8S0WB	SOD123C7V5S0WC	SOD123C8V2S0WD	SOD123C9V1S0WE
SOD123C100S0WF	SOD123C110S0WG	SOD123C120S0WH	SOD123C130S0WI	SOD123C150S0WJ
SOD123C160S0WK	SOD123C180S0WL	SOD123C200S0WM	SOD123C220S0WN	SOD123C240S0WO
SOD123C270S0WP	SOD123C300S0WQ	SOD123C330S0WR	SOD123C360S0WS	SOD123C390S0WT
SOD123C430S0WU	SOD123C470S0WV	SOD123C510S0WW	SOD123C560S0VW	
SOD123C620S06E	SOD123C680S06F	SOD123C750S06H		

SMD ZENER DIODES SOD-123 SERIES

DIMENSION (Unit: Inch/mm)

Image for reference



Marking: WP

SOD-123

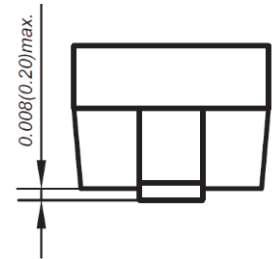
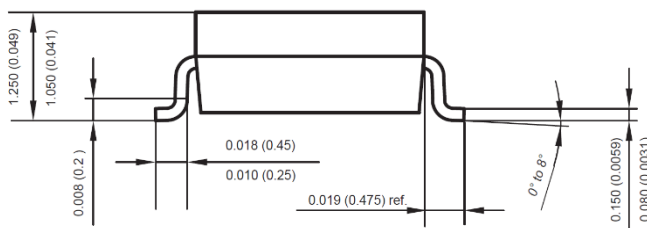
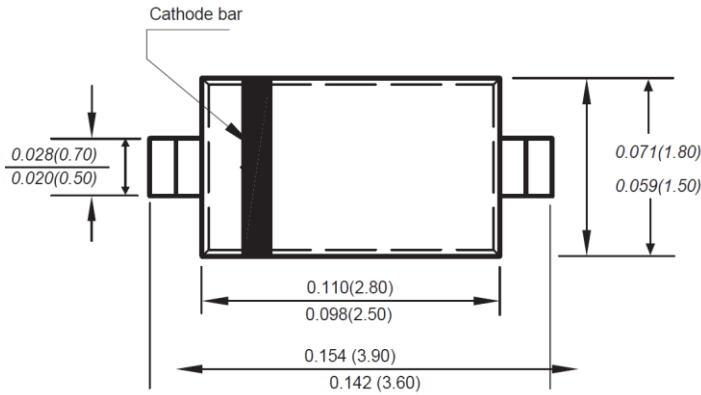

Recommend Pad Layout

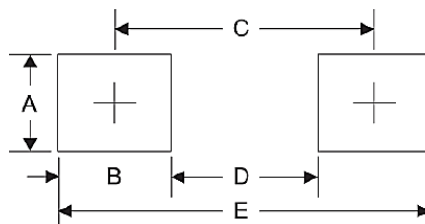

Symbol	Unit (inch)	Unit (mm)
A	0.047	1.20
B	0.047	1.20
C	0.126	3.20
D	0.079	2.00
E	0.173	4.40

SMD ZENER DIODES SOD-123 SERIES

MECHANICAL DATA

Case	Terminals	Polarity	Mounting Position	Weight per piece
JEDEC SOD-123 molded plastic body	Solder plated, Solderable per MIL-STD-750, Method 2026	Polarity symbol marking on case	Any	0.0007 Ounce, 0.0021 grams

MAX. RATING & CHARACTERISTICS - Ratings at 25°C ambient temperature unless otherwise specified.

Parameter	SYMBOLS	VALUE			UNITS
		Min.	Typical	Max.	
Forward Voltage @ IF=10mA	V _F		0.9		V
Power Dissipation	P _d		500		mW
Thermal resistance junction to ambient (See Note 1)	R _{QJA}		305		°C/W
junction temperature	T _J			+150	°C
Storage temperature range	T _{STG}	-65		+150	°C

Note

1. Thermal resistance from junction to ambient at P.C.B. mounted with 2.0" X 2.0" (5 X 5 cm) copper areas pads.

ELECTRICAL CHARACTERISTICS - Ratings at 25°C ambient temperature unless otherwise specified.

Parameter	SYMBOLS	VALUE			UNITS
		Min.	Typical	Max.	
Zenner Voltage Range @I _{ZT} =5.0mA (See Note 1)	V _{ZT}	25.1	27.0	28.9	V
Dynamic Impedance @I _{ZT} =5.0mA	Z _{ZT}			70	Ω
Reverse Current @V _R =21.0V	I _R			0.1	μA

Note

1. V_{ZT} is tested with pulses (20 ms).

SMD ZENER DIODES SOD-123 SERIES

RELIABILITY

Number	Experiment Items	Experiment Method And Conditions	Reference Documents
1	Solder Resistance Test	Test 260°C± 5°C for 10 ± 2 sec. Immerse body into solder 1/16" ± 1/32"	MIL-STD-750D METHOD-2031.2
2	Solderability Test	230°C ±5°C for 5 sec.	MIL-STD-750D METHOD-2026.1 0
3	Pull Test	1 kg in axial lead direction for 10 sec.	MIL-STD-750D METHOD-2036.4
4	Bend Test	0.5Kg Weight Applied To Each Lead, Bending Arcs 90 °C ± 5 °C For 3 Times	MIL-STD-750D METHOD-2036.4
5	High Temperature Reverse Bias Test	TA=100°C for 1000 Hours at VR=80% Rated VR	MIL-STD-750D METHOD-1038.4
6	Forward Operation Life Test	TA=25°C Rated Average Rectified Current	MIL-STD-750D METHOD-1027.3
7	Intermittent Operation Life Test	On state: 5 min with rated IRMS Power Off state: 5 min with Cool Forced Air. On and off for 1000 cycles.	MIL-STD-750D METHOD-1036.3
8	Pressure Cooker Test	15 PSIG, TA=121°C, 4 hours	MIL-S-19500 APPENOIXC
9	Temperature Cycling Test	-55°C~+125°C; 30 Minutes For Dwelled Time 5 minutes for transferred time. Total: 10 cycles.	MIL-STD-750D METHOD-1051.7
10	Thermal Shock Test	0°C for 5 minutes., 100°C for 5minutes, Total: 10 cycles	MIL-STD-750D METHOD-1056.7
11	Forward Surge Test	8.3ms Single Sale Sine-wave One Surge.	MIL-STD-750D METHOD-4066.4
12	Humidity Test	TA=65°C, RH=98% for 1000 hours.	MIL-STD-750D METHOD-1021.3
13	High Temperature Storage life Test	150°C for 1000 Hours	MIL-STD-750D METHOD-1031.5

SUGGESTED REFLOW PROFILE (For Reference Only)

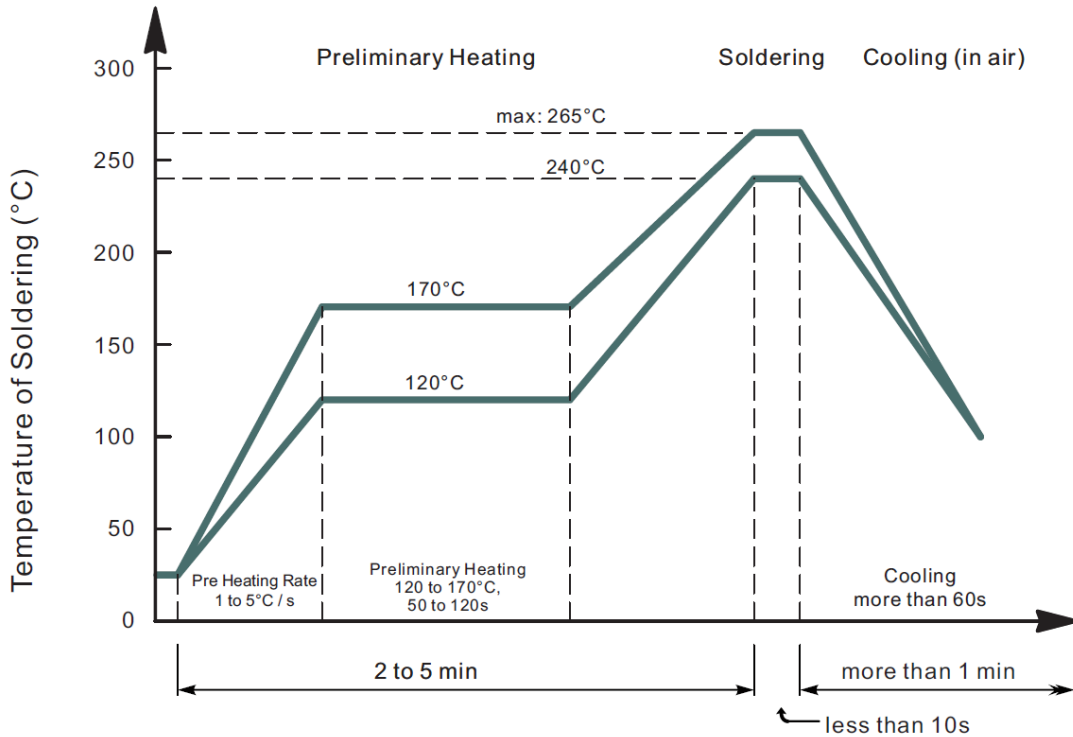

- Recommended peak temperature is over 245°C, If peak temperature is below 245 °C, you may adjust the following parameters; time length of peak temperature (longer), time length of soldering (longer), thickness of solder paste (thicker)
- Welding shall not exceed 2 times
- Remark: lead free solder paste (96.5 sn/3.0 Ag/0.5Cu)

RATINGS AND CHARACTERISTIC CURVES (For Reference Only)

Fig.1 Maximum Continuous Power Derating

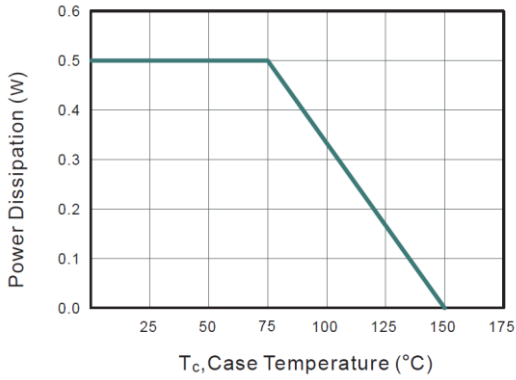
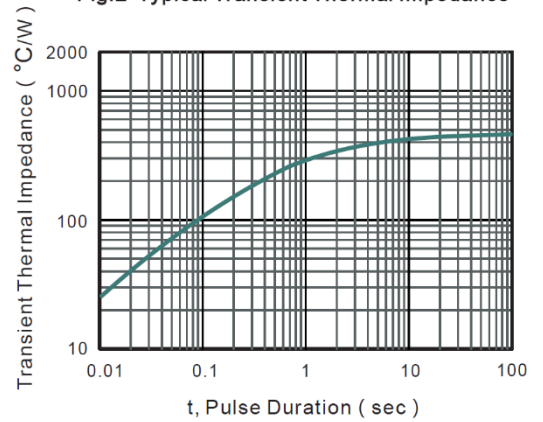

Fig.2 Typical Transient Thermal Impedance



SMD ZENER DIODES SOD-123 SERIES

TAPE/REEL (Unit: mm)

All Devices are packed in accordance with EIA standard RS-481-A and specifications.

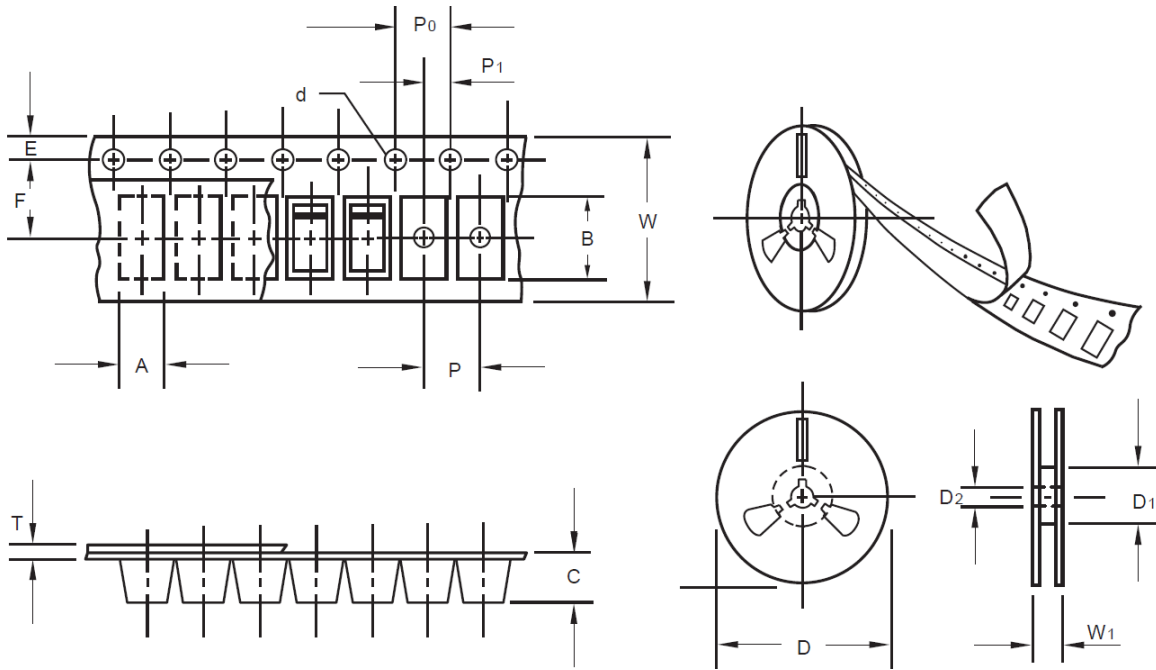

Item	Symbol	Tolerance	SO-123
Carrier width	A	0.1	2.10
Carrier Length	B	0.1	4.00
Carrier Depth	C	0.1	1.60
Sprocket hole	d	0.05	1.55
13" Reel outside diameter	-	-	-
13" Reel inner diameter	-	-	-
7" Reel outside diameter	D	2.0	178.00
7" Reel inner diameter	D1	Min.	50.00
Feed hole diameter	D2	0.5	13.00
Sprocket hole position	E	0.1	1.75
Punch hole position	F	0.1	3.50
Punch hole pitch	P	0.1	4.00
Sprocket hole pitch	P0	0.1	4.00
Embossment center	P1	0.1	2.00
Overall tape thickness	T	0.1	0.25
Tape width	W	0.3	8.15
Reel width	W1	1.0	10.50

SMD ZENER DIODES SOD-123 SERIES

PACKAGE

Case Code	Reel Size	MPQ (pcs)	Component Spacing (mm)	Qty. Per Box (pcs)	Inner Box L*W*H (mm)	Reel Size (mm)	Carton size L*W*H (mm)	Qty. Per Carton (pcs)	G. W (kg)
SOD-123	7"	3,000	4.0	24,000	210*208*203	178	400*400*250	180,000	9.0

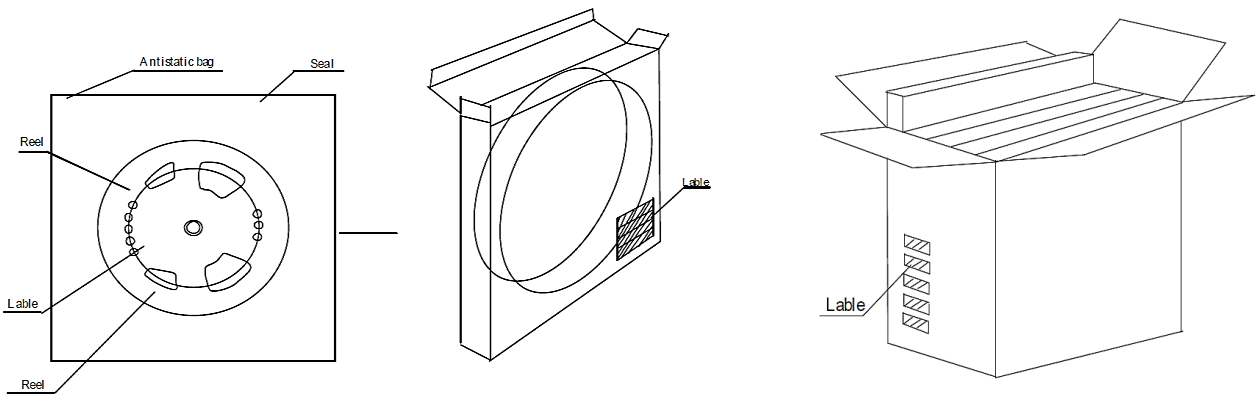

DISCLAIMER

NextGen Component, Inc. reserves the right to make changes to the product(s) and or information contained herein without notice. No liability is assumed as a result of their use or application. No rights under any patent accompany the sale of any such product(s) or information







Looking for pricing, stock, or lifecycle information?

Click below to explore more details on WIN SOURCE:

 [View BZT52C27 on WIN SOURCE](#)

 [MDD Information](#)

Optimize Your Supply Chain with WIN SOURCE Solutions

-  Global Sourcing Solution
-  Obsolete Management
-  Cost Control Management
-  Shortage Management
-  Alternative Solution
-  Excess Inventory Management