



THE DATASHEET OF
SI9988DQ-T1-E3



Buffered H-Bridge Driver with Integrate MOSFET

DESCRIPTION

The Si9988 is an integrated, buffered H-bridge with TTL compatible inputs and the capability of delivering a continuous 0.65 A at $V_{DD} = 5\text{ V}$ (room temperature) at switching rates up to 200 kHz. Internal logic prevents the upper and lower outputs of either half-bridge from being turned on simultaneously. Both outputs may be forced low (for motor braking) by pulling \overline{EN} to logic high.

The Si9988 is available in both standard and lead (Pb)-free, 8-pin TSSOP packages, specified to operate over a voltage range of 3.8 V to 13.2 V, and the industrial temperature range of -40 °C to 85 °C (D suffix).

FEATURES

- 0.65 A H-bridge
- 200 kHz switching rate
- Shoot-through limited
- TTL compatible inputs
- 3.8 V to 13.2 V operating range
- Surface mount packaging
- Total $R_{DS(on)}$ for N- and P-channel: 1.8 Ω at $V_{DD} = 4.5\text{ V}$ and $T_A = 85\text{ }^\circ\text{C}$. 0.65 A H-bridge

APPLICATIONS

- VCM driver
- Brushed motor driver
- Stepper motor driver
- Power converter
- Optical disk drives
- Power supplies
- High performance servo

FUNCTIONAL BLOCK DIAGRAM, PIN CONFIGURATION AND TRUTH TABLE

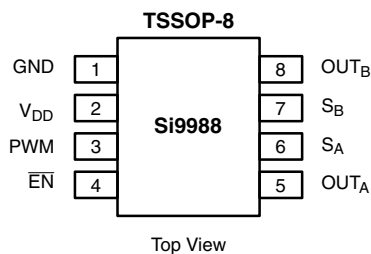

TRUTH TABLE			
EN	PWM	OUT _A	OUT _B
0	0	0	1
0	1	1	0
1	0	0	0
1	1	0	0

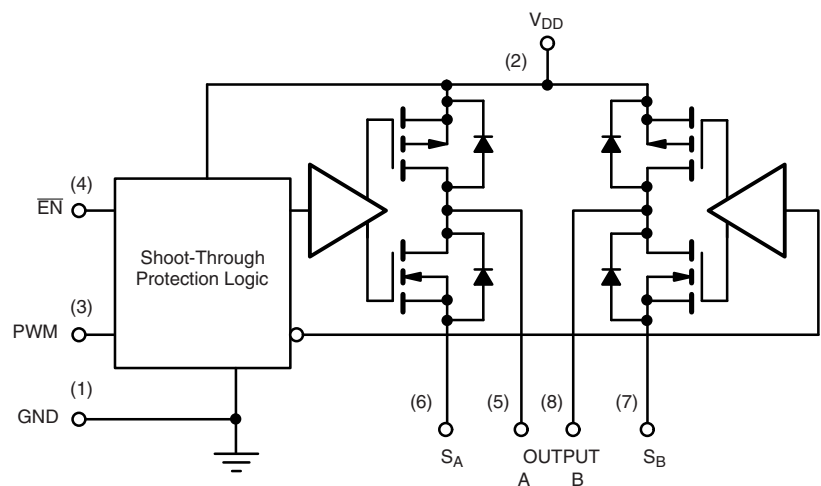

ORDERING INFORMATION

Part Number	Marking	Temperature Range	Package
Si9988DQ-T1	988	-40 °C to 85 °C	Tape and reel
Si9988DQ-T1-E3			

ABSOLUTE MAXIMUM RATINGS ^a			
Parameter	Limit	Unit	
V _{DD}	15	V	
Voltage on any Pin with Respect to Ground	- 0.3 to V _{DD} + 0.3		
Voltage on Pins 5, 8 with Respect to Ground	- 1 to V _{DD} + 1		
Voltage on Pins 6, 7	- 0.3 to GND + 1		
Peak Output Current	1	A	
Storage Temperature	- 65 to 150	°C	
Junction Temperature (T _J)	150		
Continuous I _{out} Current (T _J = 135 °C, V _{DD} = 5 V)	T _A = 25 °C	0.67	A
	T _A = 85 °C	0.47	
Power Dissipation ^b	0.83	W	
θ _{JA}	120	°C/W	
Operating Temperature Range	- 40 to 85	°C	

Notes:

a. Device mounted with all leads soldered or welded to PC board.

b. Derate 8.3 mW/°C above 25 °C.

c. T_J = T_A + (P_D)(θ_{JA}), P_D = power dissipation.

Stresses beyond those listed under "Absolute Maximum Ratings" may cause permanent damage to the device. These are stress ratings only, and functional operation of the device at these or any other conditions beyond those indicated in the operational sections of the specifications is not implied. Exposure to absolute maximum rating conditions for extended periods may affect device reliability.

RECOMMENDED OPERATING RANGE		
Parameter	Limit	Unit
V _{DD}	3.8 to 13.2	V
Maximum Junction Temperature (T _J)	135	°C

SPECIFICATIONS							
Parameter	Symbol	Test Conditions Unless Otherwise Specified V _{DD} = 3.8 to 13.2 V S _A at GND, S _B at GND	Limits D Suffix, - 40 °C to 85 °C			Unit	
			Min ^a	Typ ^b	Max ^a		
Input (\overline{EN}, PWM)							
Input Voltage High	V _{INH}		2			V	
Input Voltage Low	V _{INL}				1		
Input Current with Input Voltage High	I _{INH}	V _{IN} = 13.2 V			1	μA	
Input Current with Input Voltage Low	I _{INL}	V _{IN} = 0 V	- 1				
Output							
Output Voltage High ^c	V _{OUTH}	I _{OUT} = - 300 mA	V _{DD} = 10.8 V	10.55	10.70	V	
			V _{DD} = 4.5 V	4.20	4.35		
			V _{DD} = 3.8 V	3.40	3.62		
Output Voltage Low ^c	V _{OUTL}	I _{OUT} = 300 mA	V _{DD} = 10.8 V		0.09	0.20	
			V _{DD} = 4.5 V		0.12	0.25	
			V _{DD} = 3.8 V		0.14	0.30	
Output V Clamp High	V _{CLH}	\overline{EN} = PWM ≥ 2 V	I _{OUT} = 100 mA		V _{DD} + 0.7	V _{DD} + 1.0	V
Output V Clamp Low	V _{CLL}		I _{OUT} = - 100 mA	- 1.0	- 0.7		
Supply							
V _{DD} Supply Current	I _{DD}	\overline{EN} = 0 V, PWM = 100 kHz, V _{DD} = 5 V		1.0	1.5	mA	
		\overline{EN} = 4.5 V, PWM = 100 kHz, V _{DD} = 5.5 V		60	140		
		\overline{EN} = PWM = 4.5 V, V _{DD} = 5.5 V		55	110	μA	

SPECIFICATIONS						
Parameter	Symbol	Test Conditions Unless Otherwise Specified $V_{DD} = 3.8\text{ V to }13.2\text{ V}$ S_A at GND, S_B at GND	Limits D Suffix, -40 °C to 85 °C			Unit
			Min ^a	Typ ^b	Max ^a	
Dynamic						
Propagation Delay - OUT_A^d	T_{PLH}	$V_{DD} = 5\text{ V}, \overline{EN} = 0\text{ V}$		300		nS
	T_{PHL}			115		
Propagation Delay - OUT_B^d	T_{PLH}			75		
	T_{PHL}			330		
Break-Before-Make ^d	BBM_{PLH}			225		
	BBM_{PHL}			215		

Notes:

- a. The algebraic convention whereby the most negative value is a minimum and the most positive a maximum, is used in this data sheet.
- b. Typical values are for DESIGN AID ONLY, not guaranteed nor subject to production testing, measured $T_A = 25\text{ °C}$.
- c. Min and Max value measured at $T_J = 135\text{ °C}$.
- d. PLH = PWM low to high, PHL = PWM high to low.

TYPICAL CHARACTERISTICS (25 °C, unless otherwise noted)

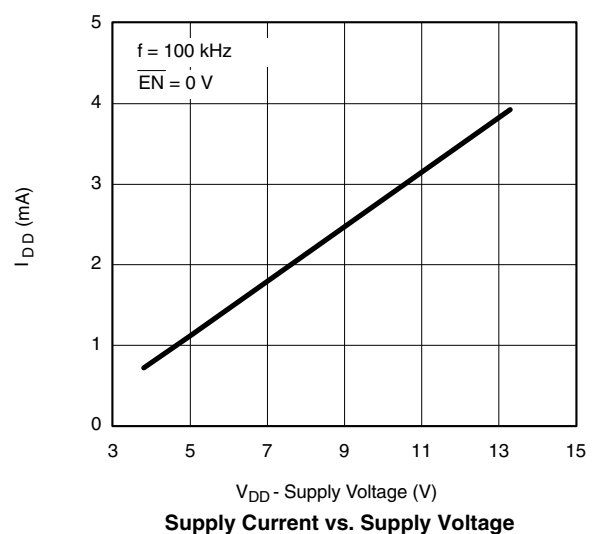
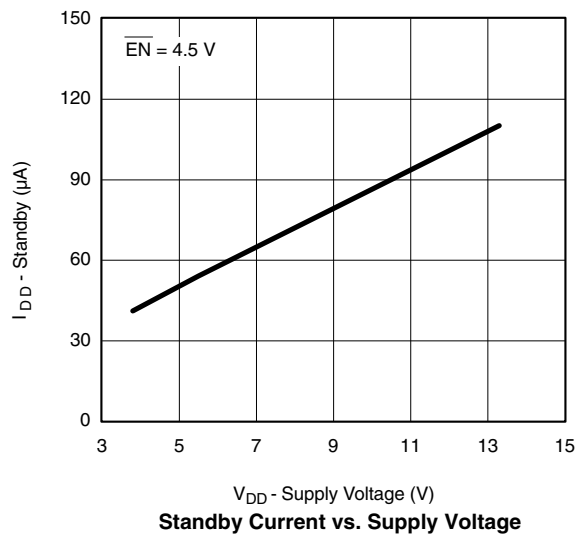
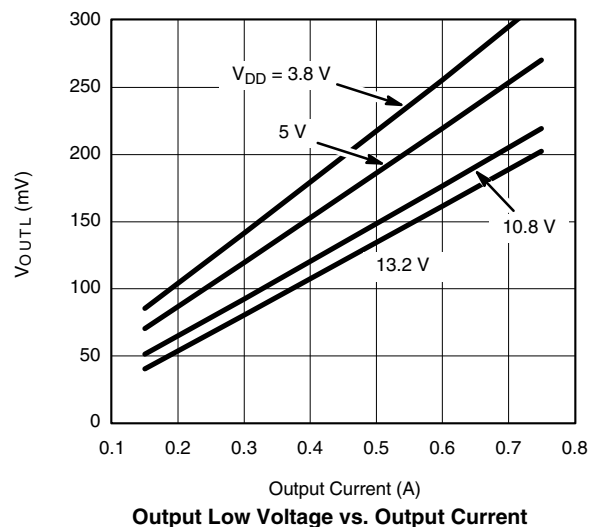
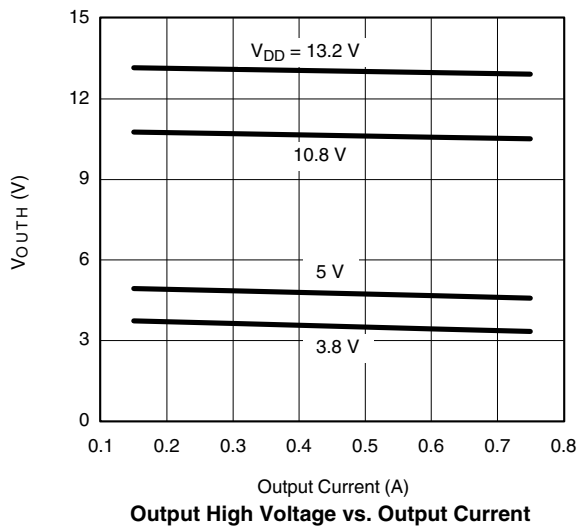

TYPICAL CHARACTERISTICS (25 °C, unless otherwise noted)

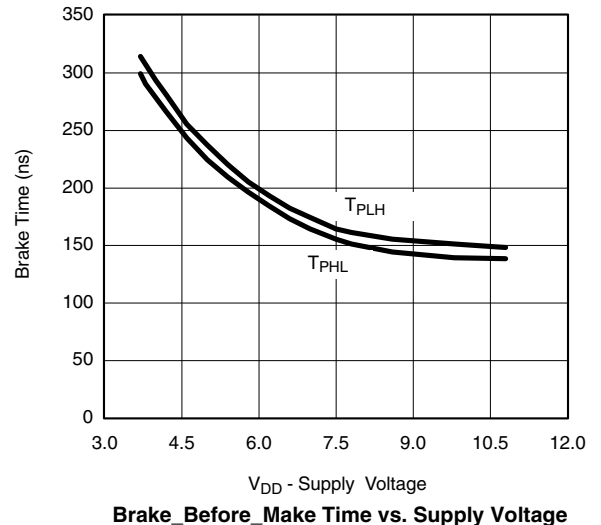
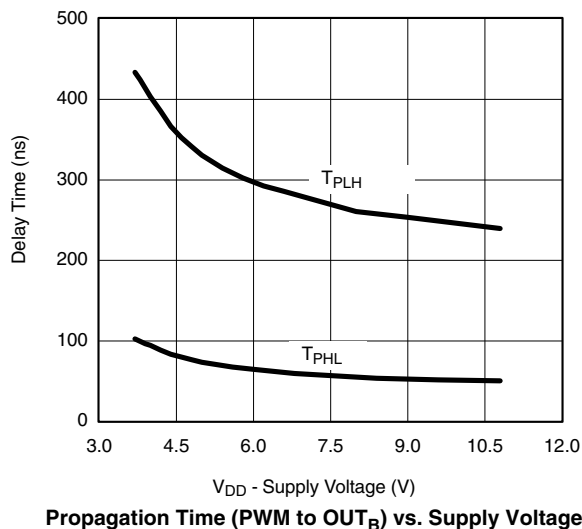
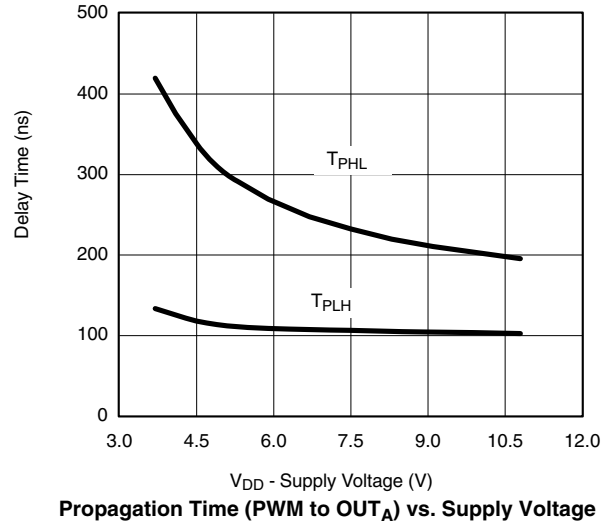
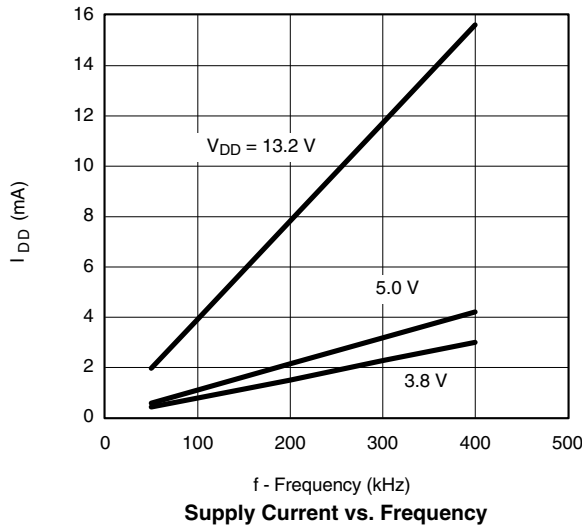
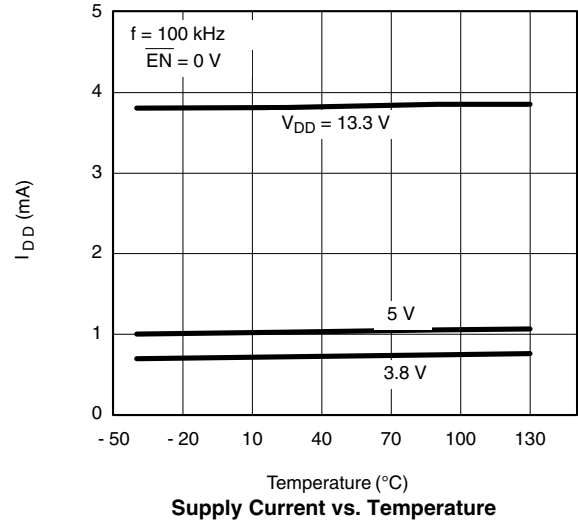
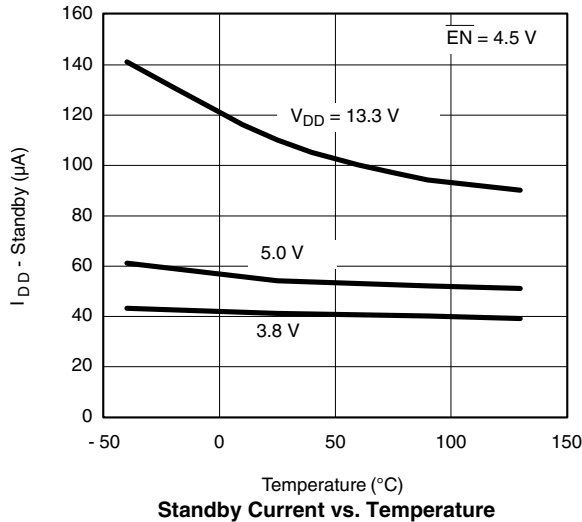

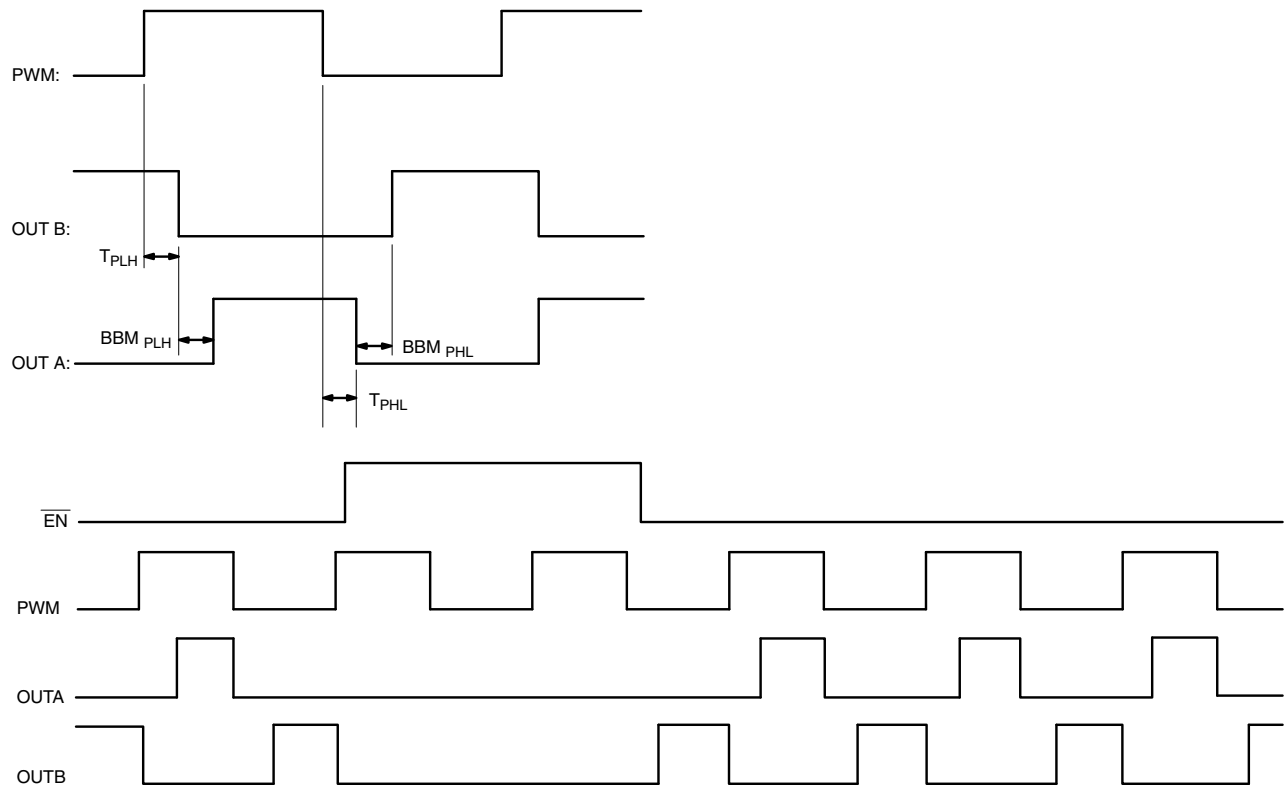
TIMING WAVEFORMS

Figure 1.

Vishay Siliconix maintains worldwide manufacturing capability. Products may be manufactured at one of several qualified locations. Reliability data for Silicon Technology and Package Reliability represent a composite of all qualified locations. For related documents such as package/tape drawings, part marking, and reliability data, see <http://www.vishay.com/ppg?71326>.

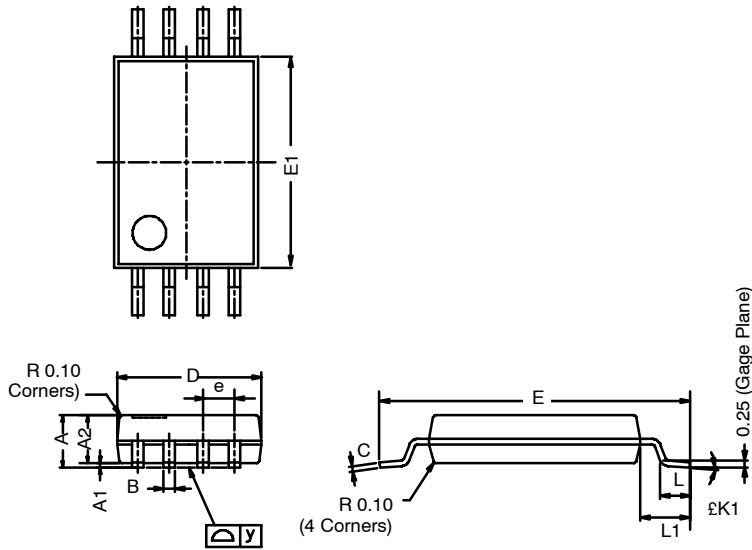

TSSOP: 8-LEAD (POWER IC ONLY)

JEDEC Part Number: MO-153



Dim	MILLIMETERS		
	Min	Nom	Max
A	-	-	1.20
A ₁	0.05	0.10	0.15
A ₂	0.80	1.00	1.05
B	0.19	0.28	0.30
C	-	0.127	-
D	2.90	3.00	3.10
E	6.20	6.40	6.60
E ₁	4.30	4.40	4.50
e	-	0.65	-
L	0.45	0.60	0.75
L ₁	0.90	1.00	1.10
Y	-	-	0.10
£K1	0°	3°	6°

ECN: S-40079—Rev. A, 02-Feb-04
DWG: 5908



Disclaimer

ALL PRODUCT, PRODUCT SPECIFICATIONS AND DATA ARE SUBJECT TO CHANGE WITHOUT NOTICE TO IMPROVE RELIABILITY, FUNCTION OR DESIGN OR OTHERWISE.

Vishay Intertechnology, Inc., its affiliates, agents, and employees, and all persons acting on its or their behalf (collectively, "Vishay"), disclaim any and all liability for any errors, inaccuracies or incompleteness contained in any datasheet or in any other disclosure relating to any product.

Vishay makes no warranty, representation or guarantee regarding the suitability of the products for any particular purpose or the continuing production of any product. To the maximum extent permitted by applicable law, Vishay disclaims (i) any and all liability arising out of the application or use of any product, (ii) any and all liability, including without limitation special, consequential or incidental damages, and (iii) any and all implied warranties, including warranties of fitness for particular purpose, non-infringement and merchantability.

Statements regarding the suitability of products for certain types of applications are based on Vishay's knowledge of typical requirements that are often placed on Vishay products in generic applications. Such statements are not binding statements about the suitability of products for a particular application. It is the customer's responsibility to validate that a particular product with the properties described in the product specification is suitable for use in a particular application. Parameters provided in datasheets and / or specifications may vary in different applications and performance may vary over time. All operating parameters, including typical parameters, must be validated for each customer application by the customer's technical experts. Product specifications do not expand or otherwise modify Vishay's terms and conditions of purchase, including but not limited to the warranty expressed therein.

Except as expressly indicated in writing, Vishay products are not designed for use in medical, life-saving, or life-sustaining applications or for any other application in which the failure of the Vishay product could result in personal injury or death. Customers using or selling Vishay products not expressly indicated for use in such applications do so at their own risk. Please contact authorized Vishay personnel to obtain written terms and conditions regarding products designed for such applications.

No license, express or implied, by estoppel or otherwise, to any intellectual property rights is granted by this document or by any conduct of Vishay. Product names and markings noted herein may be trademarks of their respective owners.

Looking for pricing, stock, or lifecycle information?

Click below to explore more details on WIN SOURCE:

 [View SI9988DQ-T1-E3 on WIN SOURCE](#)

 [Vishay Information](#)

Optimize Your Supply Chain with WIN SOURCE Solutions

-  Global Sourcing Solution
-  Obsolete Management
-  Cost Control Management
-  Shortage Management
-  Alternative Solution
-  Excess Inventory Management