



**THE DATASHEET OF  
SF1140B**



- **Designed for SDARS IF Receiver**
- **Low Insertion Loss**
- **5.0 X 7.0 mm Surface-Mount Case**
- **Differential Input and Output**
- **Complies with Directive 2002/95/EC (RoHS)**
- **Moisture Sensitivity Level: 1**
- **AEC-Q200 Qualified**

**SF1140B**

**75.00 MHz  
SAW Filter**

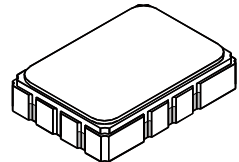

**SMP-03**

**Absolute Maximum Ratings**

Rating	Value	Units
Maximum Incident Power in Passband	+10	dBm
Max. DC voltage between any 2 terminals	30	VDC
Storage Temperature Range	-40 to +85	°C
Max Soldering Profile	265°C for 10 s	

Characteristic	Sym	Notes	Min	Typ	Max	Units
Nominal Center Frequency	$f_c$			75.000		MHz
Passband	IL	Insertion Loss at $f_c$		11.0	13.0	dB
	$BW_1$	1dB Passband	±2.1	±2.7		MHz
		Fast Amplitude Ripple over $f_c \pm 2.1$ MHz			1.0	dB <sub>P-P</sub>
	GDV	Group Delay Variation over $f_c \pm 2.1$ MHz		40	200	ns <sub>P-P</sub>
Rejection		$f_c - 15$ to $f_c - 7.15$ and $f_c + 15$ to $f_c + 65$ MHz	40	43		dB
		$f_c + 7.15$ to $f_c + 15$ MHz	36			
Operating Temperature Range	$T_A$		-40		+85	°C
Differential Input and Output Impedance			250 ohms			
Case Style			SMP-03 7 x 5 mm Nominal Footprint			
Lid Symbolization (YY=year, WW=week, S=shift, ##= Sequence Code)			RFM SF1140B YYWWS##			

**Electrical Connections**

Connection	Terminals
Port 1 Hot	10
Port 1 Ground Return	1
Port 2 Hot	5
Port 2 Ground Return	6
Case Ground	All Others

 **CAUTION: Electrostatic Sensitive Device. Observe precautions for handling.**

**NOTES:**

1. The design, manufacturing process, and specifications of this device are subject to change.
2. US or International patents may apply.
3. RoHS compliant from the first date of manufacture.

NOTES:

REV	EDN	DESCRIPTION	DATE
A	9214	INITIAL RELEASE	29nov00
B	10655	REVISED	30apr02
C	11078	REVISED	20nov02

- 1 ~~SOLDER "TAPE" 4 PLACES ONTO COMPONENT SIDE OF PCB AS SHOWN.~~
- 2 USE A WRIST STRAP WHEN SOLDERING TRANS 1, AND TRANS 2 TO PCB. (CUT LEADS .07 IN.)
- 3 MOUNT AND SOLDER ALL COMPONENTS ON PCB.
- 4 CUT CENTER CONDUCTORS FROM J1 AND J2 TO .10 IN.
- 5 MOUNT J1 AND J2 AS SHOWN (SOLDER BACKSIDE ALSO).
- 6 LABEL DEMO BOARD ACCORDINGLY.
- 7 MOUNT "FILTER" ON TOPSIDE OF PCB AS SHOWN.
8. ~~MOUNT L1 AND L2 90° TO EACH OTHER.~~
9. ~~CUT SHIELD IN TWO PIECES, "SHIELD A" AND "SHIELD B", SOLDER TO PCB AS SHOWN.~~

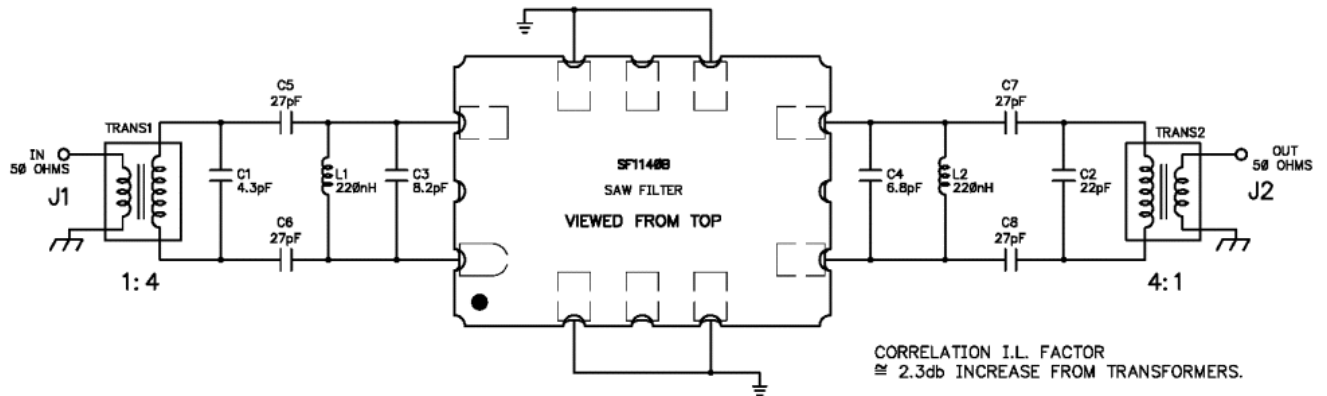

TITLE				
ASSY DIAGRAM, SF1140B-DEMO, S, TD				
SIZE	FSCM NO.	DWG. NO.	REV	SHEET
B	2U874	SF1140B-100	C	1/2

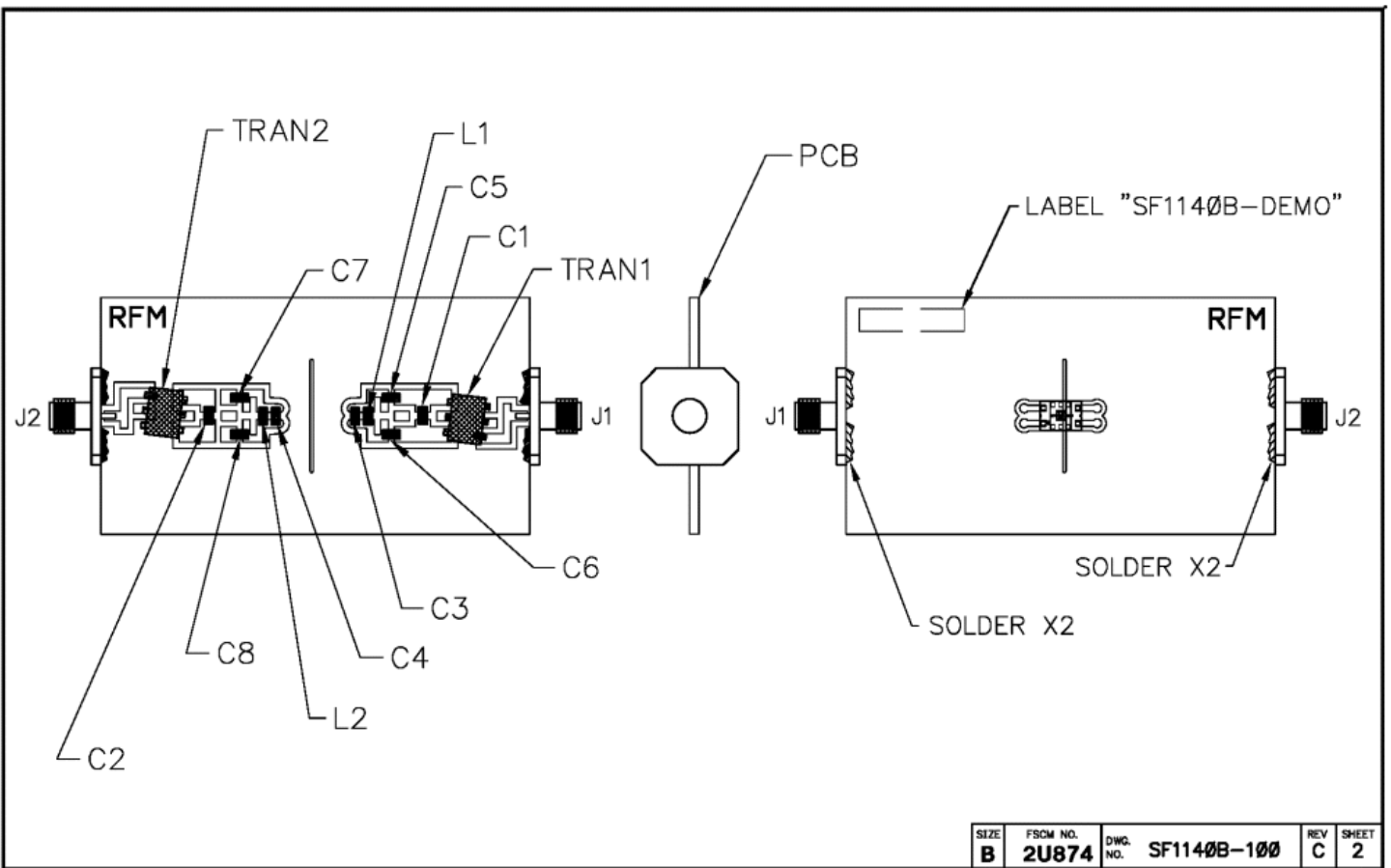

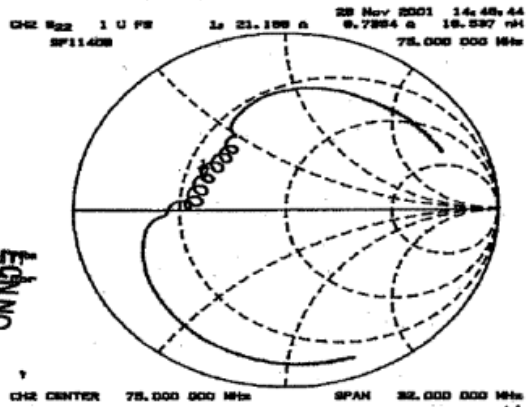
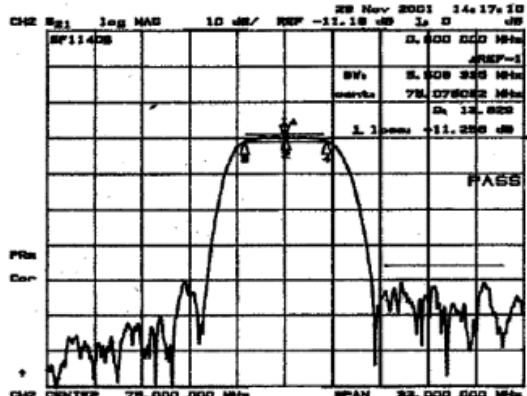
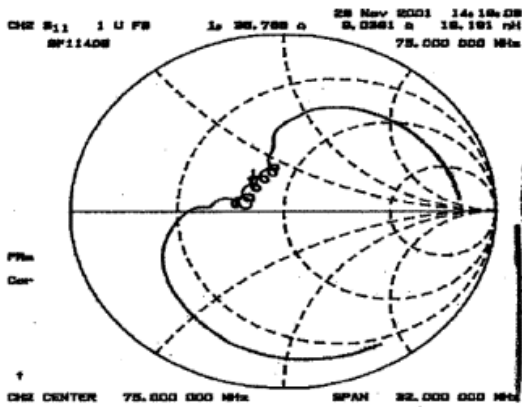
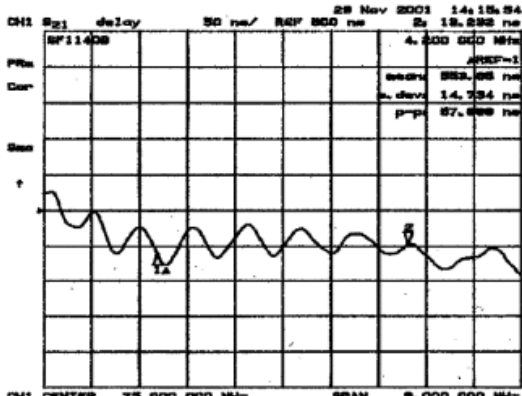

SF1140B  
 Devs 3  
 DC010612  
 Fix EN61  
 423-1140-100

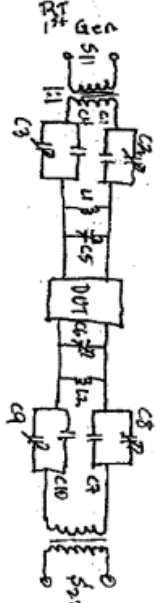

C1, C4 = 22 pf  
 C7, C8 = 1-5 pf  
 C2, C3 = 1-5 pf  
 L1 = 220 nH  
 L2 = 2.5-10 pf

11078  
 SHEET 3/0

EDN NO.

SIZE	A	FSM NO.	2U874	DWG NO.	432-1140-113	REV	A
SCALE	NONE	EDN NO.	11078	SHEET	4	OF	4

# Tape and Reel Specifications

Tape and Reel Standard per ANSI/EIA481

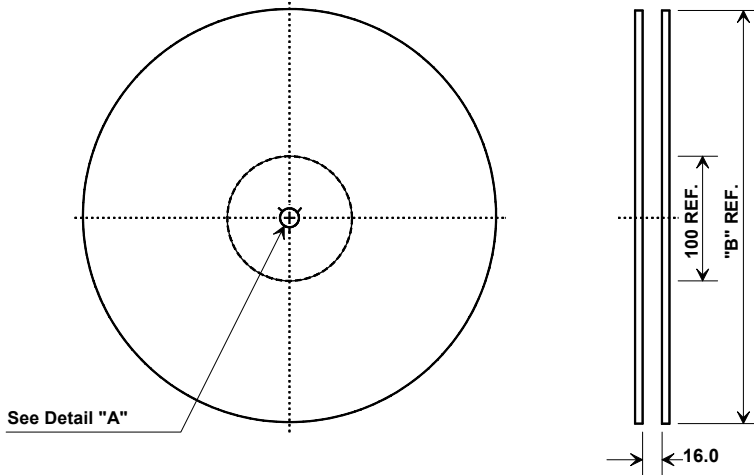

"B "		Quantity Per Reel
Nominal Size		
Inches	millimeters	
7	178	500
13	330	2000

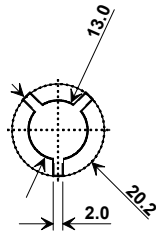

## COMPONENT ORIENTATION and DIMENSIONS

Carrier Tape Dimensions		Tolerance
<b>Ao</b>	5.5 mm	± 0.1mm
<b>Bo</b>	7.5 mm	± 0.1mm
<b>Ko</b>	2.0 mm	± 0.1mm
<b>Pitch</b>	8.0 mm	± 0.1mm
<b>W</b>	16.0 mm	± 0.2mm

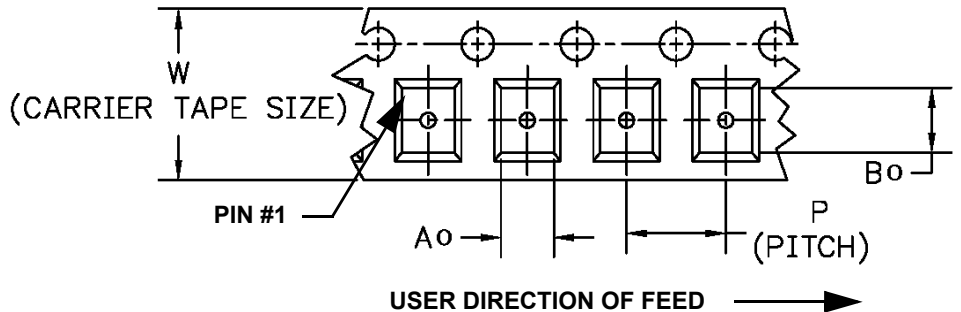
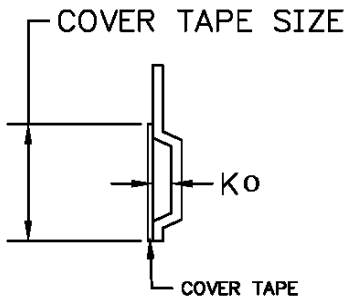

# SMP-03 Case

## 10-Terminal Ceramic Surface-Mount Case

### 7 x 5 mm Nominal Footprint

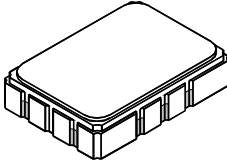

#### Recommended PCB Footprint

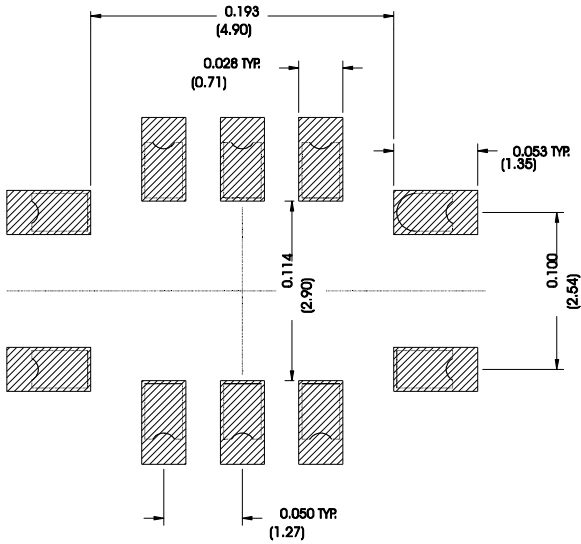

Case Dimensions						
Dimension	mm			Inches		
	Min	Nom	Max	Min	Nom	Max
A	6.80	7.00	7.20	0.268	0.276	0.283
B	4.80	5.00	5.20	0.189	0.197	0.205
C		1.65	2.00		0.065	0.079
D	.47	0.60	.73	0.019	0.024	0.029
E	2.41	2.54	2.67	0.095	0.100	0.105
H	0.87	1.0	1.13	0.034	0.039	0.044
J	4.87	5.00	5.13	0.192	0.197	0.202
K	2.87	3.00	3.13	0.113	0.118	0.123
P	1.14	1.27	1.40	0.045	0.050	0.055

Materials	
Solder Pad Termination	Au plating 30 - 60 ulnches (76.2-152 uM) over 80-200 ulnches (203-508 uM) Ni.
Lid	Fe-Ni-Co Alloy Electroless Nickel Plate (8-11% Phosphorus) 100-200 ulnches Thick
Body	Al <sub>2</sub> O <sub>3</sub> Ceramic

Electrical Connections		
Connection		Terminals
Port 1	Input or Return	10
	Return or Input	1
Port 2	Output or Return	5
	Return or Output	6
Ground		All others
Single Ended Operation		Return is ground
Differential Operation		Return is hot

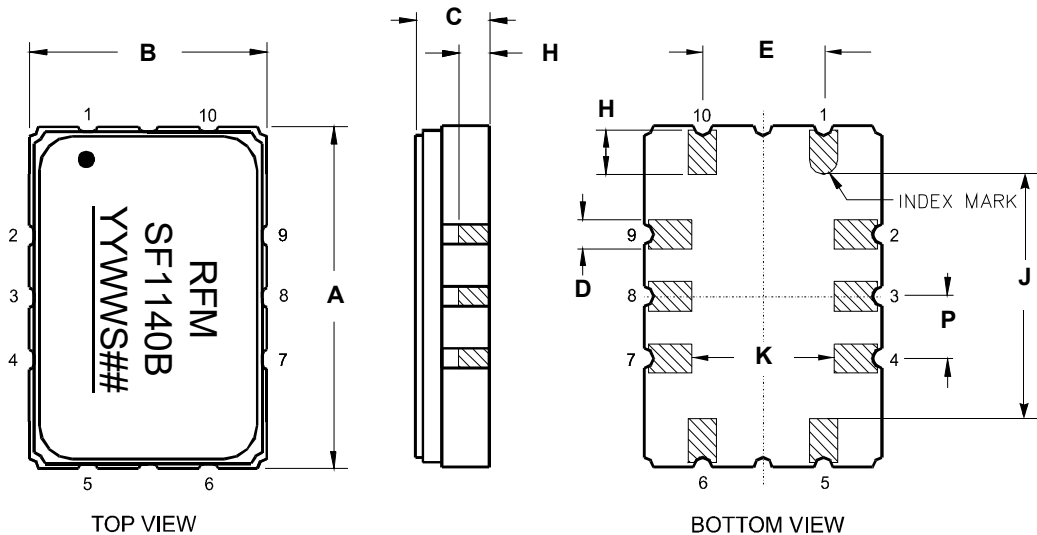

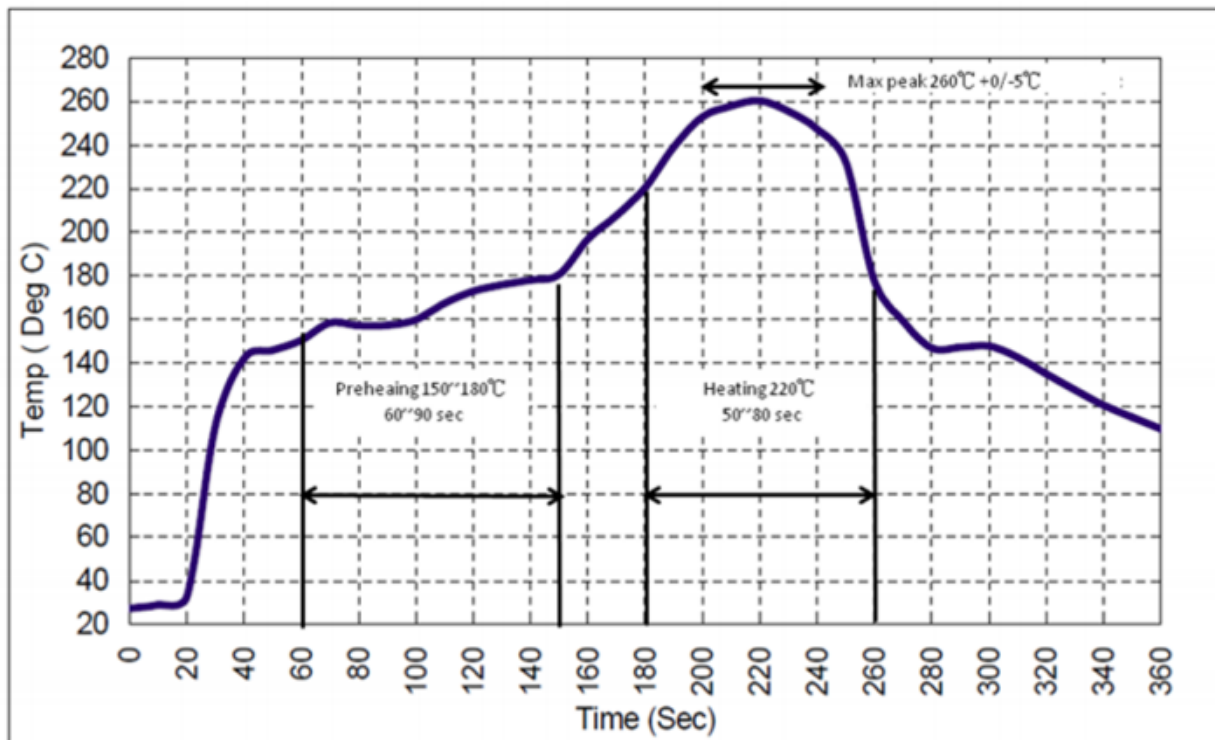

## Recommended Reflow Profile

1. Preheating shall be fixed at 150~180°C for 60~90 seconds.
2. Ascending time to preheating temperature 150°C shall be 30 seconds min.
3. Heating shall be fixed at 220°C for 50~80 seconds and at 260°C+0/-5°C peak (10 seconds).
4. Time: 5 times maximum.



## Looking for pricing, stock, or lifecycle information?

Click below to explore more details on WIN SOURCE:

-  [View SF1140B on WIN SOURCE](#)
-  [RF Monolithics, Inc Information](#)

## Optimize Your Supply Chain with WIN SOURCE Solutions

-  Global Sourcing Solution
-  Obsolete Management
-  Cost Control Management
-  Shortage Management
-  Alternative Solution
-  Excess Inventory Management