

Device Features

- OIP3 = 44.0 dBm @ 70 MHz
- Gain = 20.3 dB @ 70 MHz
- Output P1 dB = 23.5 dBm @ 70 MHz
- Patented over voltage protection
- RoHS2-compliant SOT-89 SMT package



Product Description

BeRex's BIF3 is a high performance InGaP/ GaAs HBT MMIC amplifier, internally matched to 50 Ohms and uses a patented **over voltage protection** circuit to protect a internal device. The BIF3 is designed for high linearity IF amplifier that requires excellent gain, high OIP3 and flatness. It is packaged in a RoHS2-compliant with SOT-89 surface mount package.

Applications

- Base station Infrastructure/RFID
- Commercial/Industrial/Military wireless system

Applications Circuit

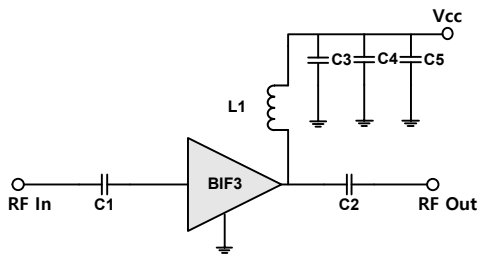

*C1, C2=8200pF ± 5%; C3 = 100 pF ± 5%; C4 = 1000pF ±5%

*C5 = 10uF; L1 = 680nH ±5%

Electrical Specifications

Device performance _ measured on a BeRex evaluation board at 25°C, Vc=5V, 50 Ω system.

Parameter	Conditions	Min	Typ	Max	Unit
Operational Frequency Range		5		800	MHz
Test Frequency			70		MHz
Gain		18.8	20.3		dB
Input Return Loss			-19.0		dB
Output Return Loss			-16.0		dB
Output IP3	8 dBm / tone , Δf=1 MHz	41.0	44.0		dBm
Output P1dB		22.5	23.5		dBm
Noise Figure			5.1		dB

Recommended Operating Conditions

Parameter	Min	Typ	Max	Unit
Bandwidth	5		800	MHz
I _c @ (V _c = 5V)	68	85	102	mA
V _c	4.0	5.0	5.25	V
dG/dT		-0.004		dB/°C
R _{TH}		45		°C/W
Operating Case Temperature	-40		+85	°C

Electrical specifications are measured at specified test conditions.

Specifications are not guaranteed over all recommended operating conditions.

Absolute Maximum Ratings

Parameter	Rating	Unit
Storage Temperature	-55 to +155	°C
Junction Temperature	+170	°C
Supply Voltage	+6.0	V
Supply Current	140	mA
Input RF Power	23	dBm

Operation of this device above any of these parameters may result in permanent damage.

Above 7V, a device goes to protection mode.

5-800 MHz Internally Matched IF Amplifier

Typical Performance (Vd = 5V, Ic = 85mA, T = 25°C)

Freq	MHz	70	140	250	500	800
S21	dB	20.3	20.2	19.9	19.0	17.9
S11	dB	-19.0	-18.0	-15.0	-11.0	-8.0
S22	dB	-16.0	-17.0	-16.0	-13.0	-11.0
P1	dBm	23.5	24.5	24.5	24.2	24.0
OIP3	dBm	44.0	41.5	40.5	40.5	39.5
NF	dB	5.1	5.2	5.2	5.3	5.3

Typical Performance (Vd = 4.7V, Ic = 64mA, T = 25°C)

Freq	MHz	70	140	250	500	800
S21	dB	20.1	19.9	19.7	18.9	17.6
S11	dB	-27.2	-24.6	-16.8	-11.3	-9.3
S22	dB	-13.1	-12.6	-13.0	-12.5	-9.7
P1	dBm	22.9	23.5	23.3	23.3	22.7
OIP3	dBm	35.0	38.5	39.5	36.5	35.3
NF	dB	5.1	5.2	5.2	5.3	5.3

Typical Performance (Vd = 4.5V, Ic = 54mA, T = 25°C)

Freq	MHz	70	140	250	500	800
S21	dB	20.2	20.2	19.8	18.7	17.5
S11	dB	-18.8	-19.0	-16.1	-11.8	-9.2
S22	dB	-14.1	-16.0	-15.1	-11.8	-9.6
P1	dBm	22.1	23.0	23.1	22.6	22.2
OIP3	dBm	34.5	37.5	34.5	35.5	34.5
NF	dB	5.1	5.2	5.2	5.3	5.3

Typical Performance (Vd = 4V, Ic = 28mA, T = 25°C)

Freq	MHz	70	140	250	500	800
S21	dB	19.5	19.4	19.1	18.1	16.8
S11	dB	-18.4	-18.5	-15.8	-11.5	-8.9
S22	dB	-12.3	-13.8	-13.5	-11.3	-9.4
P1	dBm	20.7	21.2	21.2	20.7	13.5
OIP3	dBm	35.0	29.0	27.5	25.5	31.0
NF	dB	5.1	5.2	5.2	5.3	5.3

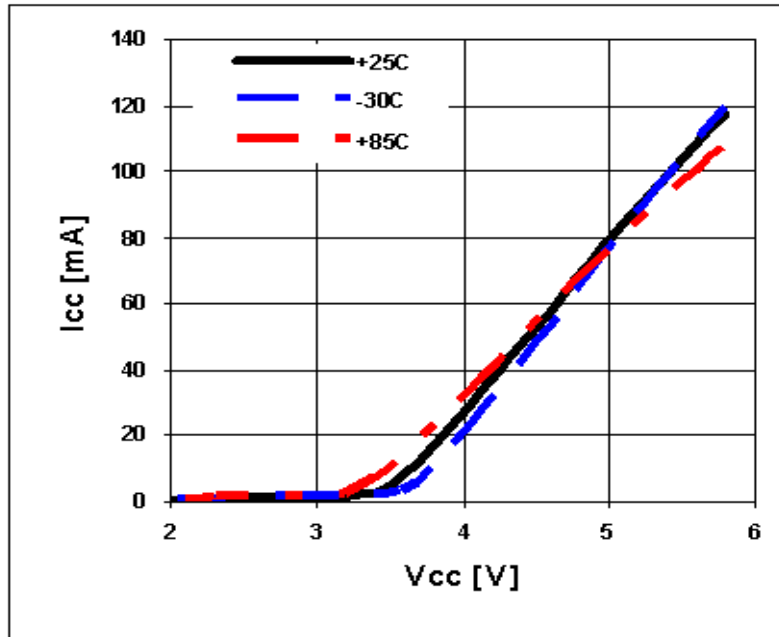
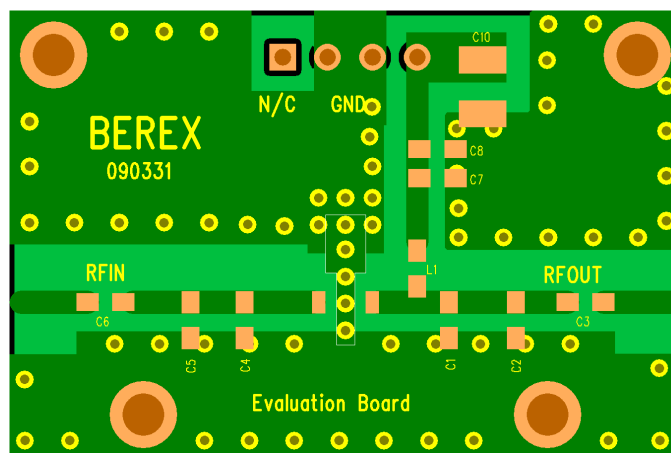
V-I Characteristics

BeRex SOT89 Evaluation Board

*Dielectric constant _ 4.2 *RF pattern width 52mil *31mil thick FR4 PCB

Typical Device Data

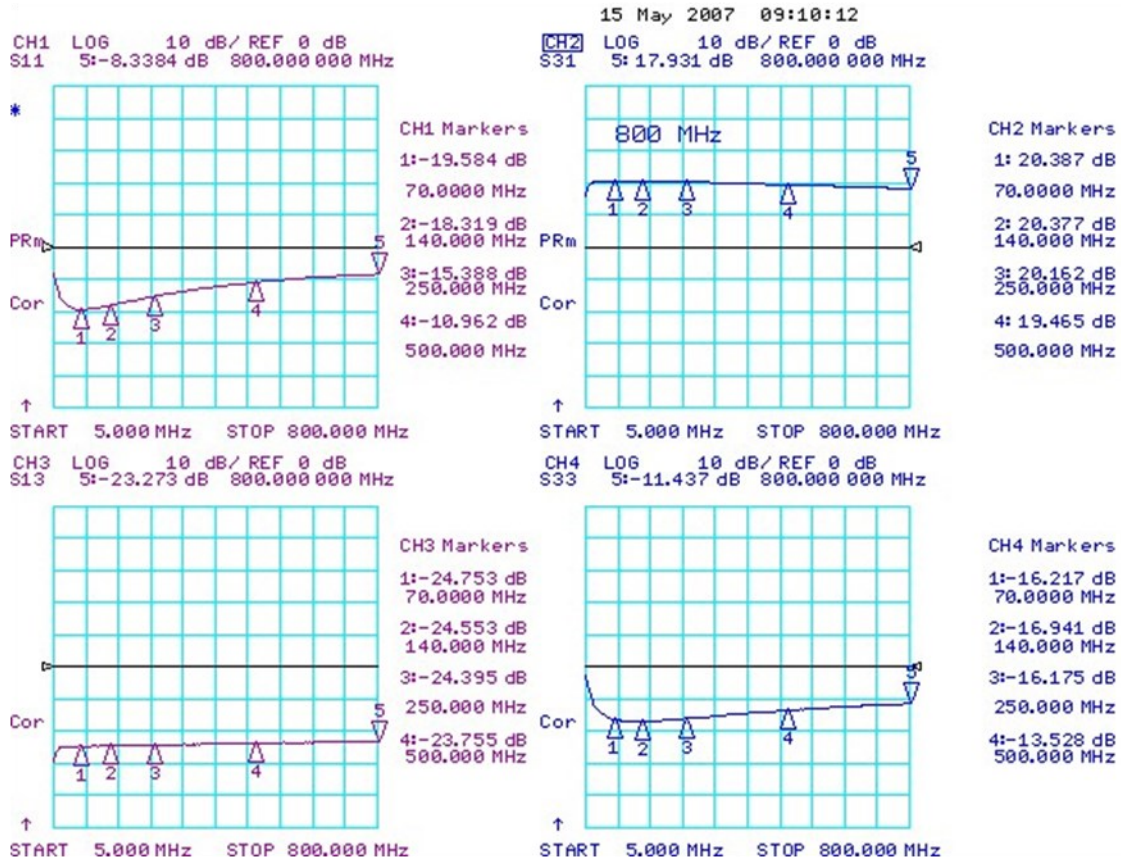
S-parameters (Vc=5V, Ic=85mA, T=25°C)



S-Parameter

(Vdevice = 5.0V, Icc = 85mA, T = 25 °C, calibrated to device leads)

Freq [MHz]	S11	S11	S21	S21	S12	S12	S22	S22
	[Mag]	[Ang]	[Mag]	[Ang]	[Mag]	[Ang]	[Mag]	[Ang]
100	0.624	178.2	10.523	169.9	0.059	1.5	0.096	-26.0
500	0.678	164.5	7.809	137.3	0.069	0.3	0.162	-107.1
1000	0.748	144.2	5.812	155.4	0.067	-0.4	0.223	-156.6
1500	0.788	121.2	4.823	100.6	0.078	-7.1	0.272	167.3
2000	0.790	102.1	4.095	82.6	0.070	-23.9	0.271	140.3
2500	0.861	76.9	3.935	74.1	0.076	-17.5	0.305	116.8
3000	0.873	54.1	4.121	51.6	0.072	-41.4	0.327	94.2
3500	0.955	26.4	3.614	30.1	0.061	-39.1	0.347	75.9
4000	1.037	-3.3	3.252	11.4	0.060	-53.2	0.362	55.0

Typical Performance
(Vd = 5V, Ic = 85mA, T = 25°C)

OIP3

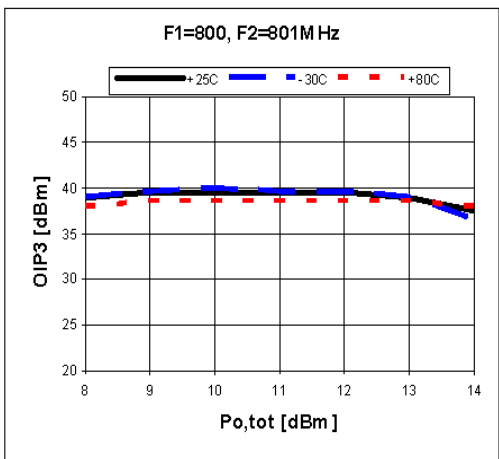
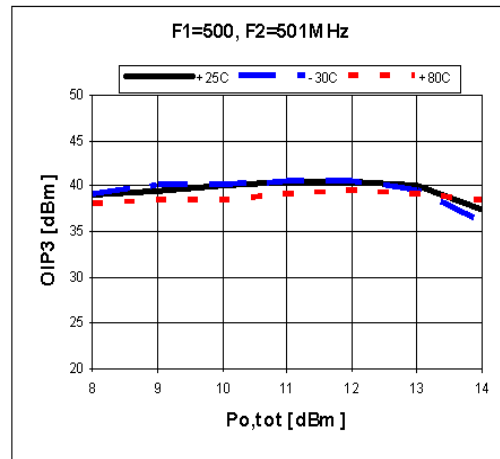
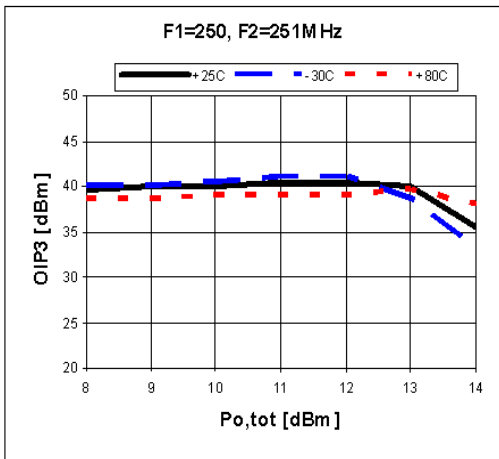
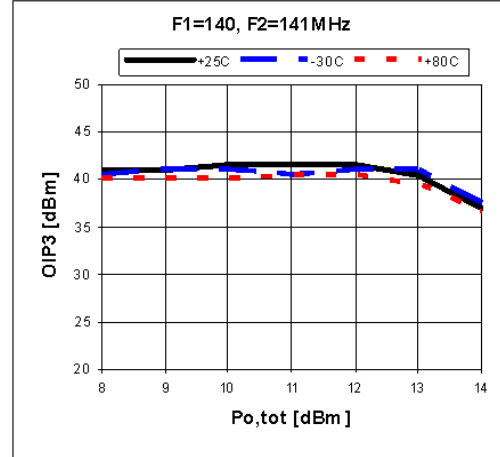
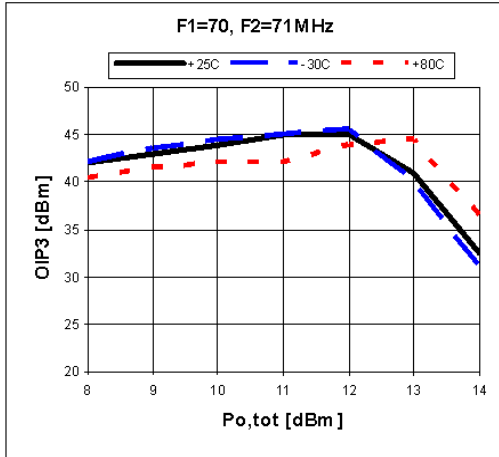

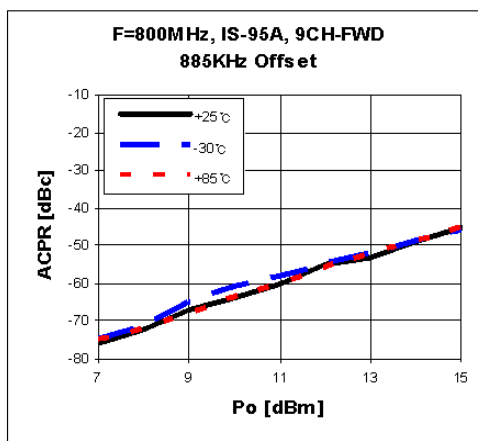
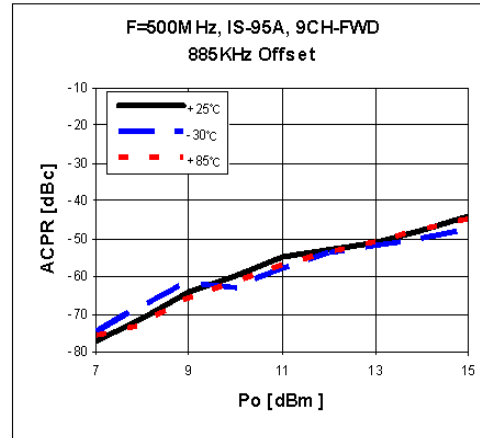
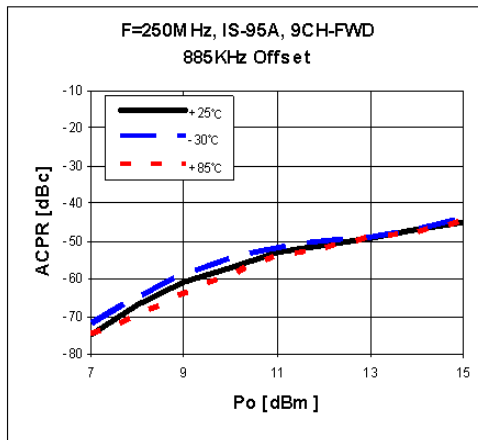
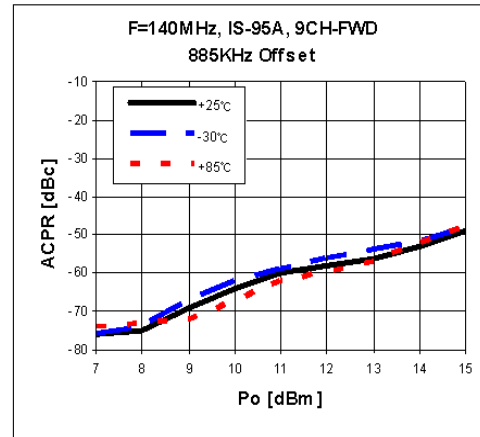
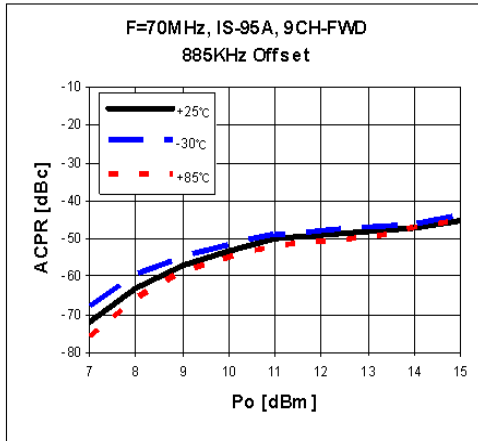
ACPR

ACLR

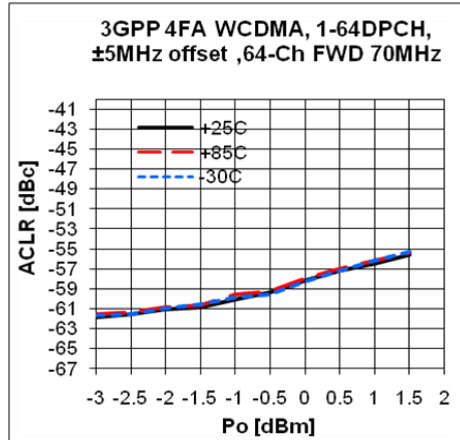

S-Parameters(S11/S22)

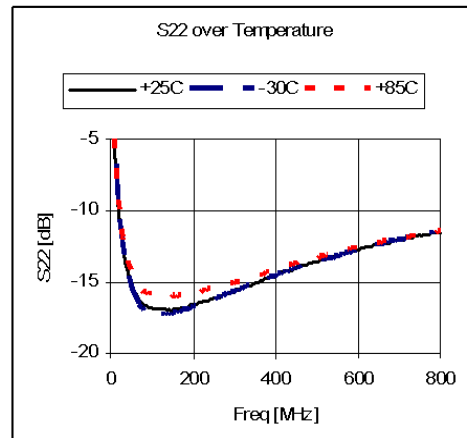
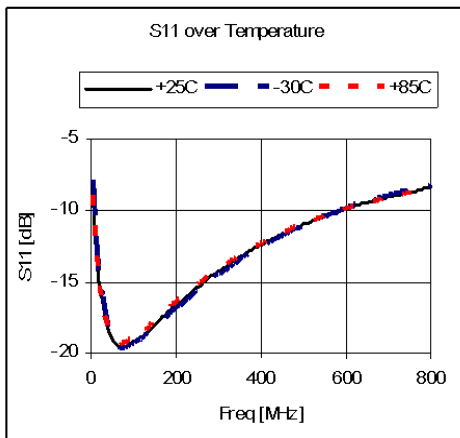

Gain Flatness

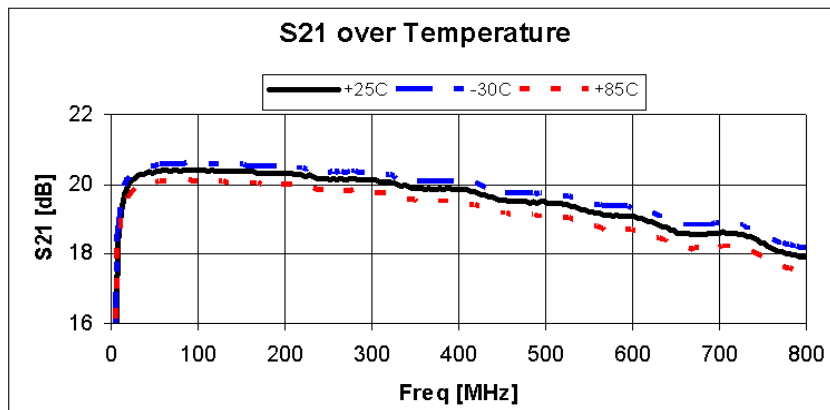

Package Outline Dimension

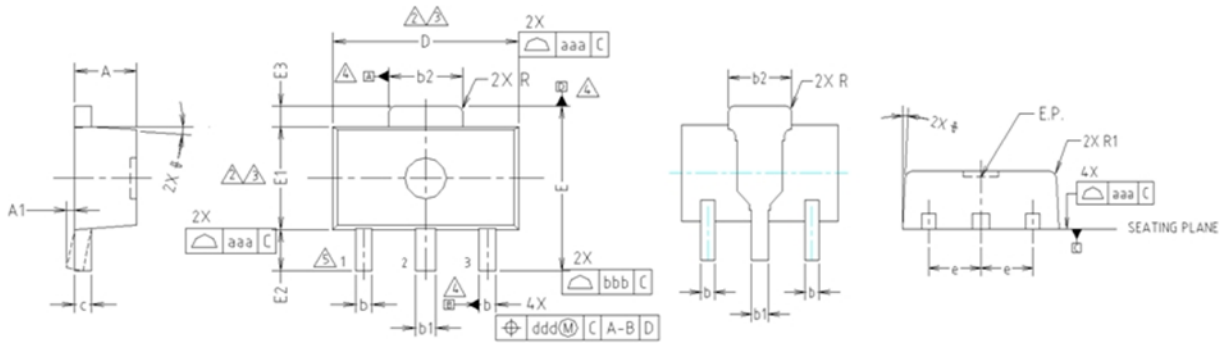

- NOTE:**
 1. DIMENSIONS IN MILLIMETERS.
- ⚠ DIMENSION D DOES NOT INCLUDE MOLD FLASH, PROTRUSIONS OR GATE BURRS. MOLD FLASH, PROTRUSIONS OR GATE BURRS SHALL NOT EXCEED 0.5mm PER END. DIMENSION E1 DOES NOT INCLUDE INTERLEAD FLASH OR PROTRUSION. INTERLEAD FLASH OR PROTRUSION SHALL NOT EXCEED 0.5mm PER SIDE.
 - ⚠ DIMENSIONS D AND E1 ARE DETERMINED AT THE OUTMOST EXTREMES OF THE PLASTIC BODY EXCLUSIVE OF MOLD FLASH, TIE BAR BURRS, GATE BURRS AND INTERLEAD FLASH, BUT INCLUDING ANY MISMATCH BETWEEN THE TOP AND BOTTOM OF THE PLASTIC BODY.
 - ⚠ DATUMS A, B AND D TO BE DETERMINED 0.18mm FROM THE LEAD TIP.
 - ⚠ TERMINAL NUMBERS ARE SHOWN FOR REFERENCE ONLY.

SYMBOL	MILLIMETERS			NOTE
	MINIMUM	NOMINAL	MAXIMUM	
A	1.40	1.50	1.60	
A1	0.00	—	0.10	
b	0.38	0.42	0.48	
b1	0.48	0.52	0.58	
b2	1.79	1.82	1.87	
c	0.40	0.42	0.46	
D	4.40	4.50	4.70	2,3
E	3.70	4.00	4.30	
E1	2.40	2.50	2.70	2,3
E2	0.80	1.00	1.20	
E3	0.40	0.50	0.60	
e	1.50 TYP.			
φ	4° TYP.			
R	0.15 TYP.			
R1	—	—	0.20	
SYMBOL	TOLERANCES OF FORM AND POSITION		NOTE	
aaa	0.15			
bbb	0.20			
ccc	0.10			
ddd	0.10			

Suggested PCB Land Pattern and PAD Layout

PCB Land Pattern

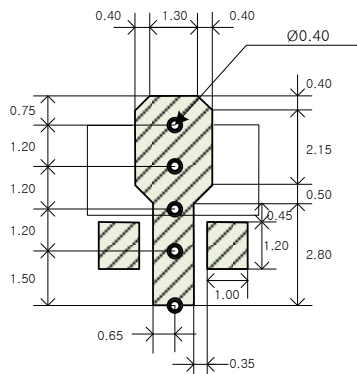

Note : All dimension _ millimeters

PCB lay out _ on BeRex website

PCB Mounting

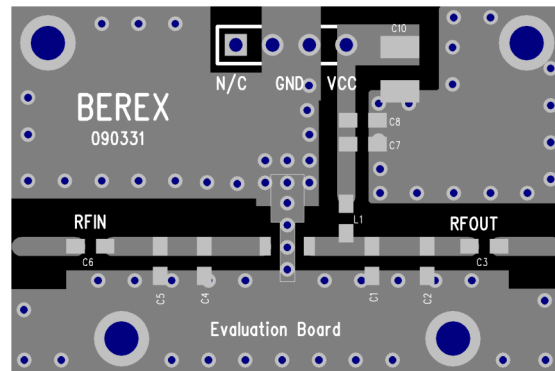

Package Marking

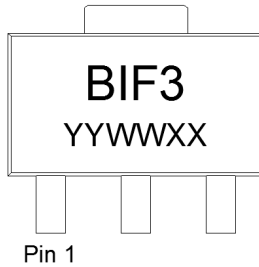

YY = Year, WW = Working Week,
XX = Wafer No.

Tape & Reel

SOT89

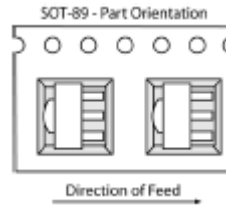

Packaging information:

Tape Width (mm): 12
Reel Size (inches): 7
Device Cavity Pitch (mm): 8
Devices Per Reel: 1000

Lead plating finish

100% Tin Matte finish

(All BeRex products undergoes a 1 hour, 150 degree C, Anneal bake to eliminate thin whisker growth concerns.)

MSL / ESD Rating

ESD Rating:	Class 1C
Value:	Passes <2000V
Test:	Human Body Model (HBM)
Standard:	JEDEC Standard JESD22-A114
MSL Rating:	Level 1 at +260°C convection reflow
Standard:	JEDEC Standard J-STD-020



Proper ESD procedures should be followed when handling this device.

RoHS Compliance

This part is compliant with Restrictions on the Use of Certain Hazardous Substances in Electrical and Electronic Equipment (RoHS) Directive 2011/65/EU as amended by Directive 2015/863/EU.



This product also is compliant with a concentration of the Substances of Very High Concern (SVHC) candidate list which are contained in a quantity of less than 0.1%(w/w) in each components of a product and/or its packaging placed on the European Community market by the BeRex and Suppliers.

NATO CAGE code:

2	N	9	6	F
---	---	---	---	---

Looking for pricing, stock, or lifecycle information?

Click below to explore more details on WIN SOURCE:

-  [View BIF3 on WIN SOURCE](#)
-  [BeRex Corporation](#) Information

Optimize Your Supply Chain with WIN SOURCE Solutions

-  Global Sourcing Solution
-  Obsolete Management
-  Cost Control Management
-  Shortage Management
-  Alternative Solution
-  Excess Inventory Management