



**THE DATASHEET OF
CZRW5229B-G**



CZRW5223B-G Thru. CZRW5256B-G

Voltage: 2.7 to 30 Volts

Power: 350 mWatts

RoHS Device

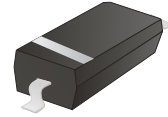

Features

- For surface mounted applications.
- Ultra-Small surface medium package.
- General purpose, medium current.
- Ideally suited for automated assembly processes.

Mechanical data

- Case: SOD-123, Molded plastic.
- Terminals: Solder Plated, solderable per MIL-STD-750, method 2026.
- Polarity: Cathode band.
- Weight: 0.01 gram (approx.).

Circuit Diagram

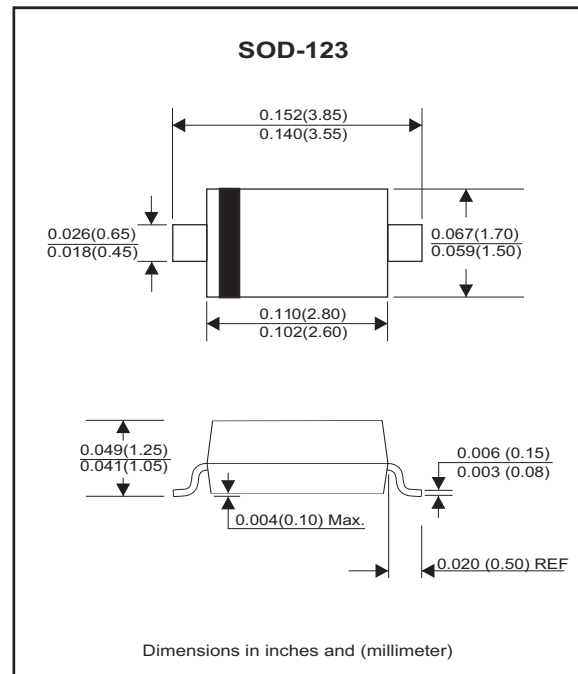

Maximum Rating (@Ta=25°C unless otherwise specified)

Parameter	Symbol	Value	Unit
Forward Voltage (Note 2) @ I _F =10mA	V _F	0.9	V
Power Dissipation (Note 1)	P _D	350	mW
Thermal Resistance, Junction to Ambient Air	R _{θJA}	357	°C/W
Operating and Storage Temperature Range	T _J , T _{STG}	-65 to +150	°C

Notes: 1. Device mounted on ceramic PCB; 7.6mm x 9.4mm x 0.87mm with pad areas 25mm².
 2. Tested with pulses, T_p ≤ 1.0ms.

Electrical Characteristics(@Ta = 25°C unless otherwise specified)

Part Number	Zener Voltage			Operating resistance		Rising operating resistance		Reverse current		Marking Code
	Vz(V)@IzT			ZzT(Ohm)		Zzk(Ohm)		IR(uA)		
	Min	Nom	Max	Max	IzT(mA)	Max	Izk(mA)	Max	Vr(V)	
CZRW5223B-G	2.57	2.7	2.84	30	20	1300	0.25	75	1.0	C3
CZRW5225B-G	2.85	3.0	3.15	30	20	1600	0.25	50	1.0	C5
CZRW5226B-G	3.14	3.3	3.47	28	20	1600	0.25	25	1.0	G1
CZRW5227B-G	3.42	3.6	3.78	24	20	1700	0.25	15	1.0	G2
CZRW5228B-G	3.71	3.9	4.10	23	20	1900	0.25	10	1.0	G3
CZRW5229B-G	4.09	4.3	4.52	22	20	2000	0.25	5	1.0	G4
CZRW5230B-G	4.47	4.7	4.94	19	20	1900	0.25	5	2.0	G5
CZRW5231B-G	4.85	5.1	5.36	17	20	1600	0.25	5	2.0	E1
CZRW5232B-G	5.32	5.6	5.88	11	20	1600	0.25	5	3.0	E2
CZRW5233B-G	5.70	6.0	6.30	7	20	1600	0.25	5	3.5	E3
CZRW5234B-G	5.89	6.2	6.51	7	20	1000	0.25	5	4.0	E4
CZRW5235B-G	6.46	6.8	7.14	5	20	750	0.25	3	5.0	E5
CZRW5236B-G	7.13	7.5	7.88	6	20	500	0.25	3	6.0	F1
CZRW5237B-G	7.79	8.2	8.61	8	20	500	0.25	3	6.5	F2
CZRW5238B-G	8.27	8.7	9.14	8	20	600	0.25	3	6.5	F3
CZRW5239B-G	8.65	9.1	9.56	10	20	600	0.25	3	7.0	F4
CZRW5240B-G	9.50	10	10.50	17	20	600	0.25	3	8.0	F5
CZRW5241B-G	10.45	11	11.55	22	20	600	0.25	2	8.4	H1
CZRW5242B-G	11.40	12	12.60	30	20	600	0.25	1	9.1	H2
CZRW5243B-G	12.35	13	13.65	13	9.5	600	0.25	0.5	9.9	H3
CZRW5244B-G	13.30	14	14.70	15	9.0	600	0.25	0.1	10	H4
CZRW5245B-G	14.25	15	15.75	16	8.5	600	0.25	0.1	11	H5
CZRW5246B-G	15.20	16	16.80	17	7.8	600	0.25	0.1	12	J1
CZRW5248B-G	17.10	18	18.90	21	7.0	600	0.25	0.1	14	J3
CZRW5250B-G	19.00	20	21.00	25	6.2	600	0.25	0.1	15	J5
CZRW5251B-G	20.90	22	23.10	29	5.6	600	0.25	0.1	17	K1
CZRW5252B-G	22.80	24	25.20	33	5.2	600	0.25	0.1	18	K2
CZRW5253B-G	23.75	25	26.25	35	5.0	600	0.25	0.1	19	K3
CZRW5254B-G	25.65	27	28.35	41	5.0	600	0.25	0.1	21	K4
CZRW5255B-G	26.60	28	29.40	44	4.5	600	0.25	0.1	21	K5
CZRW5256B-G	28.50	30	31.50	49	4.2	600	0.25	0.1	23	M1

RATING AND CHARACTERISTIC CURVES (CZRW5223B-G Thru CZRW5256B-G)

Fig.1 - Power Derating Curve

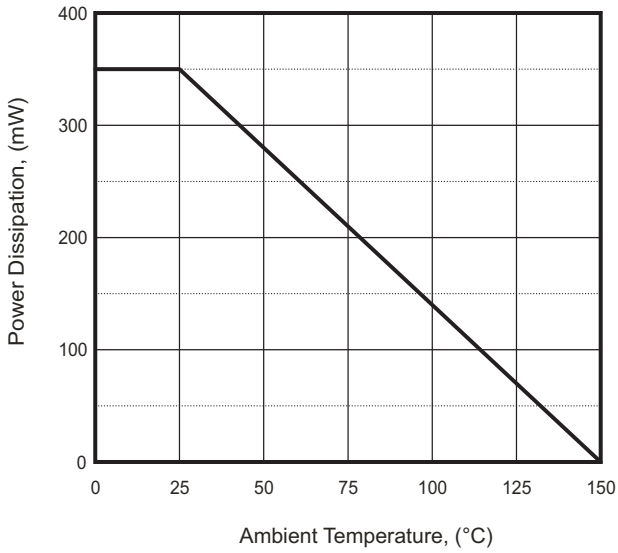

Fig.2 - Forward Characteristics

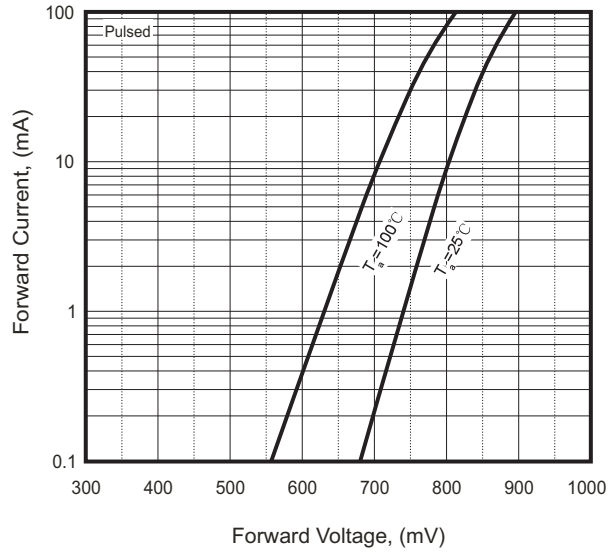

Fig.3 - Reverse Characteristics

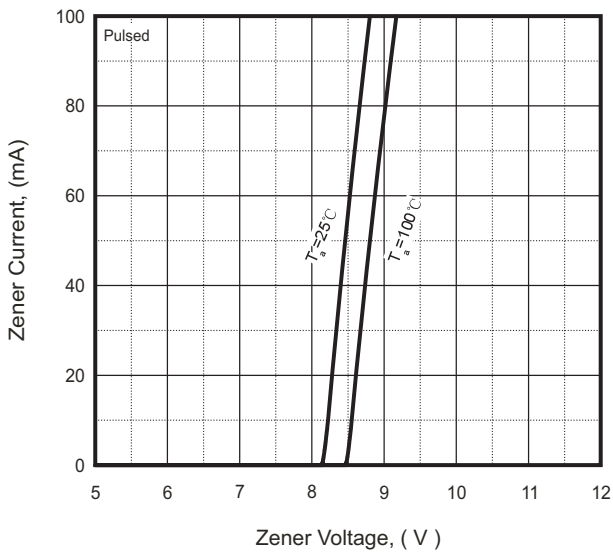
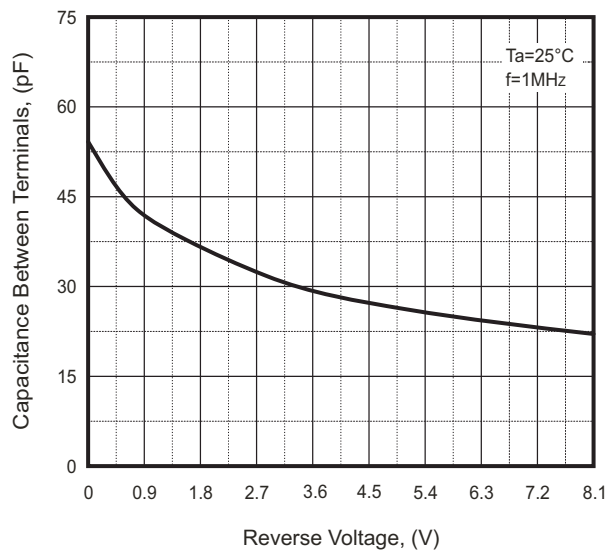
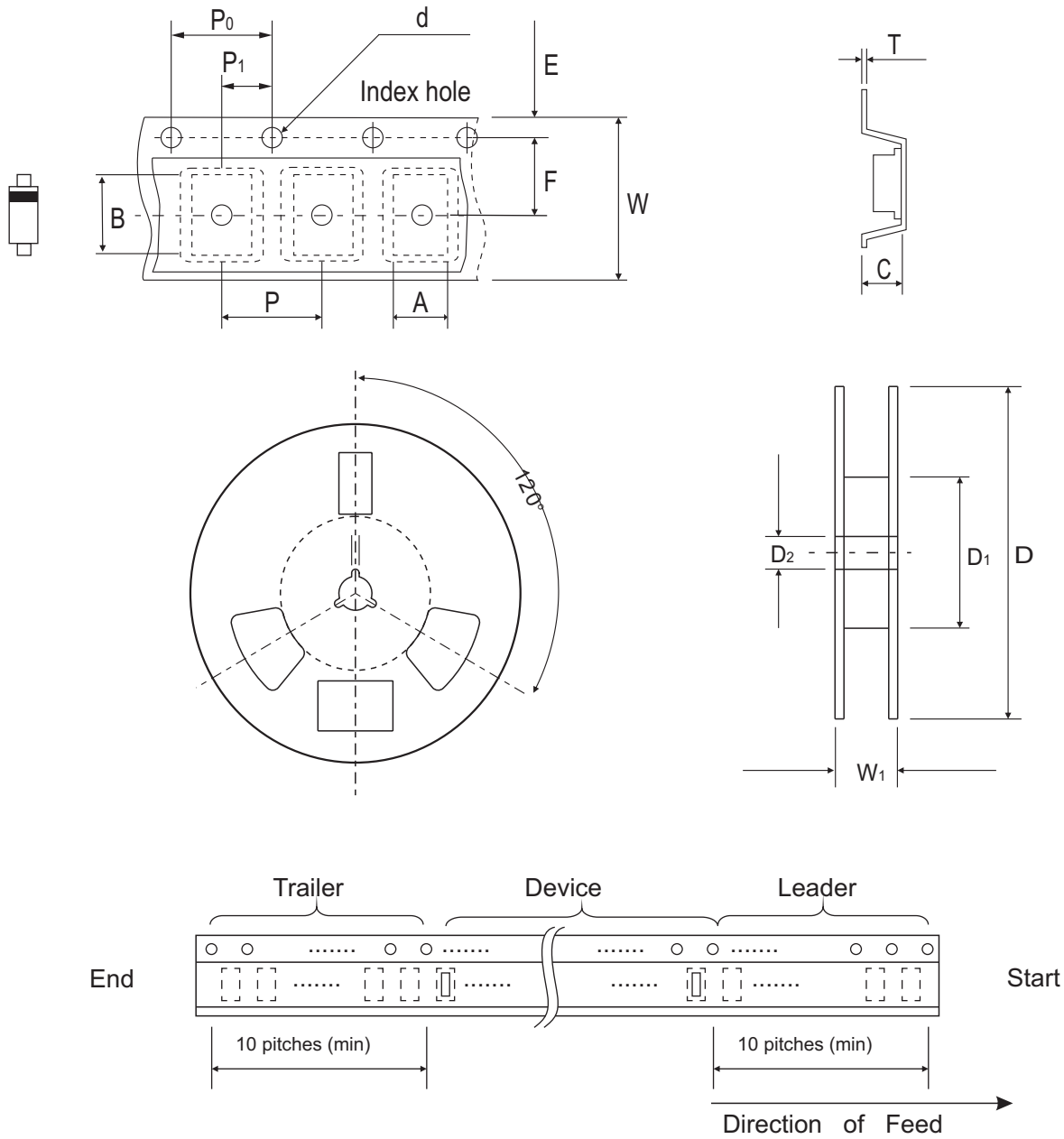

Fig.4 - Capacitance Characteristics



Reel Taping Specification



SOD-123	SYMBOL	A	B	C	d	D	D1	D2
	(mm)	1.85 ± 0.10	3.94 ± 0.10	1.57 ± 0.10	1.55 ± 0.10	178 ± 1.00	54.40 ± 0.40	13.0 ± 0.20
	(inch)	0.073 ± 0.004	0.155 ± 0.004	0.062 ± 0.004	0.061 ± 0.004	7.008 ± 0.039	2.142 ± 0.016	0.512 ± 0.008

SOD-123	SYMBOL	E	F	P	P0	P1	W	W1
	(mm)	1.75 ± 0.10	3.50 ± 0.05	4.00 ± 0.10	4.00 ± 0.10	2.00 ± 0.10	8.00+0.30/-0.10	9.50 ± 1.00
	(inch)	0.069 ± 0.004	0.138 ± 0.002	0.158 ± 0.004	0.158 ± 0.004	0.079 ± 0.004	0.315+0.012/-0.004	0.374 ± 0.039

Marking Code

Part Number	Marking Code
CZRW5223B-G ~ CZRW5256B-G	XX



Product type marking code (see page.2)

Suggested PAD Layout

SIZE	SOD-123	
	(mm)	(inch)
A	3.35	0.132
B	0.80	0.031
C	1.00	0.039
D	4.15	0.163
E	2.55	0.100

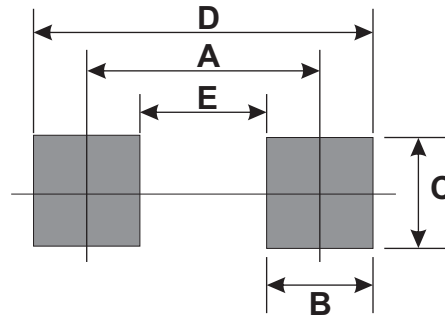

Standard Packaging

Case Type	REEL PACK	
	REEL (pcs)	Reel Size (inch)
SOD-123	3,000	7

Looking for pricing, stock, or lifecycle information?

Click below to explore more details on WIN SOURCE:

-  [View CZRW5229B-G on WIN SOURCE](#)
-  [Comchip Technology Information](#)

Optimize Your Supply Chain with WIN SOURCE Solutions

-  Global Sourcing Solution
-  Obsolete Management
-  Cost Control Management
-  Shortage Management
-  Alternative Solution
-  Excess Inventory Management