



**THE DATASHEET OF
SMP1302-003LF**



DATA SHEET

SMP1302 Series: Switch and Attenuator Plastic-Packaged PIN Diodes

Applications

- TV distribution and cellular base stations
- High volume switch and attenuators

Features

- Designed for base station and handset applications
- Low-distortion design
- Available in tape and reel packaging
- Packages rated MSL1 @ 260 °C per JEDEC J-STD-020



Skyworks Green™ products are compliant with all applicable legislation and are halogen-free. For additional information, refer to *Skyworks Definition of Green™*, document number SQ04-0074.



Description





The SMP1302 series of plastic-packaged, surface-mountable, low-capacitance (0.3 pF) silicon PIN diodes is designed for high-volume switch and attenuator applications from 10 MHz to beyond 10 GHz.

These diodes are designed for use in low-distortion TEE attenuators with low drive current (maximum resistance at 1 mA is 10 Ω) commonly used in TV distribution and cellular base station applications. The nominal 50 μm I region width, combined with a maximum resistance of 3 Ω at 10 mA, makes these diodes useful in large signal switch applications.

The SMP1302 series provides single, dual, and quad diodes in a selection of plastic packages including SOT-23, SOD-323, SC-79, SC-88, and a small footprint SOD-882.

Table 1 describes the various packages and marking of the SMP1302 series.

Table 1. SMP1302 Series Packaging and Marking

				
Common Anode	Single	Single	Quad Common Cathode	Single
SOT-23	SOD-323 Green™	SC-79 Green™	SC-88	SOD-882 Green™
			SMP1302-078LF Marking: XIX	SMP1302-040LF Marking: W
SMP1302-003LF Green™ Marking: RF9	SMP1302-011LF Marking: RF	◆ SMP1302-079LF Marking: Cathode and C3		
$L_s = 1.5 \text{ nH}$	$L_s = 1.5 \text{ nH}$	$L_s = 0.7 \text{ nH}$	$L_s = 1.4 \text{ nH}$	$L_s = 0.45 \text{ nH}$

SMP1302-078LF Pinout

Table 2 provides the signal pin assignments for the 6-pin SC-88 quad common cathode package.

Electrical and Mechanical Specifications

The absolute maximum ratings of the SMP1302 series are provided in Table 3. Electrical specifications are provided in Table 4. Resistance versus temperature measurements are provided in Table 5.

Typical performance characteristics of the SMP1302 series are illustrated in Figures 1 to 4. Package dimensions are shown in Figures 5 to 13 (odd numbers), and tape and reel dimensions are provided in Figures 6 to 14 (even numbers).

Table 2. SMP1302-078LF Pin Signals

Pin	Name	Pin	Name
1	Anode 1	4	Anode 3
2	Common cathode	5	Common cathode
3	Anode 2	6	Anode 4

Table 3. SMP1302 Series Absolute Maximum Ratings¹

Parameter	Symbol	Minimum	Maximum	Units
Reverse voltage	V_R		200	V
Power dissipation @ 25 °C lead temperature	P_D		250	mW
Storage temperature	T_{STG}	-65	+150	°C
Operating temperature	T_A	-65	+150	°C
Electrostatic discharge: Human Body Model (HBM), Class 1C	ESD	1000	2000	V

¹ Exposure to maximum rating conditions for extended periods may reduce device reliability. There is no damage to device with only one parameter set at the limit and all other parameters set at or below their nominal value. Exceeding any of the limits listed here may result in permanent damage to the device.

ESD HANDLING: Although this device is designed to be as robust as possible, electrostatic discharge (ESD) can damage this device. This device must be protected at all times from ESD when handling or transporting. Static charges may easily produce potentials of several kilovolts on the human body or equipment, which can discharge without detection. Industry-standard ESD handling precautions should be used at all times.

Table 4. SMP1302 Series Electrical Specifications¹
($T_A = +25$ °C, Unless Otherwise Noted)

Parameter	Symbol	Test Condition	Min	Typ	Max	Units
Reverse current	I_R	$V_R = 200$ V			10	μ A
Capacitance	C_T	$f = 1$ MHz, $V = 30$ V			0.3	pF
Resistance	R_S	$f = 100$ MHz : $I = 1$ mA $I = 10$ mA $I = 100$ mA		15	20 3 1.5	Ω Ω Ω
Forward voltage	V_F	$I_F = 10$ mA		0.8		V
Carrier lifetime	T_I	$I_F = 10$ mA		0.7		μ s
I region width				50		μ m

¹ Performance is guaranteed only under the conditions listed in this table..

Package and Handling Information

Instructions on the shipping container label regarding exposure to moisture after the container seal is broken must be followed. Otherwise, problems related to moisture absorption may occur when the part is subjected to high temperature during solder assembly.

The SMP1302 series is rated to Moisture Sensitivity Level 1 (MSL1) at 260 °C. It can be used for lead or lead-free soldering.

For additional information, refer to the Skyworks Application Note, *Solder Reflow Information*, document number 200164.

Care must be taken when attaching this product, whether it is done manually or in a production solder reflow environment. Production quantities of this product are shipped in a standard tape and reel format.

Table 5. Resistance vs Temperature @ 100 MHz

I_F (mA)	R_S @ -55 °C (Ω)	R_S @ -15 °C (Ω)	R_S @ +25 °C (Ω)	R_S @ +65 °C (Ω)	R_S @ +100 °C (Ω)
0.02	599	653	692	715	722
0.10	123	135	143	154	161
0.3	42.2	46.6	49.7	54.3	56.8
1.0	13.5	15.0	16.2	17.9	18.8
10	2.0	2.3	2.6	2.9	3.0
20	1.34	1.50	1.70	2.00	2.00
100	0.60	0.74	1.00	1.10	1.10

Typical Performance Characteristics
($T_A = +25\text{ °C}$, Unless Otherwise Noted)

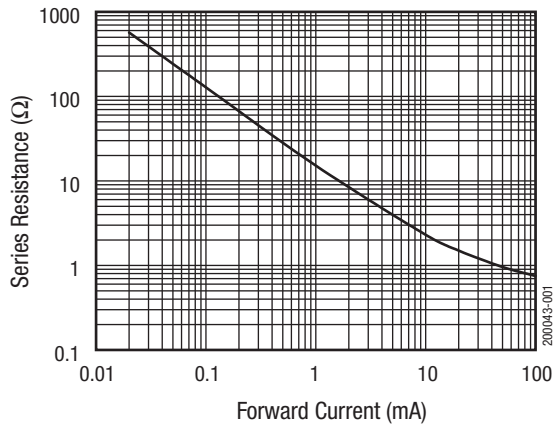

Figure 1. Series Resistance vs Current @ 100 MHz

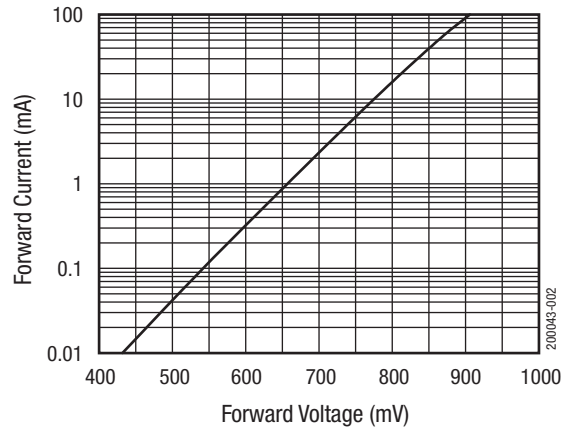

Figure 2. DC Characteristic

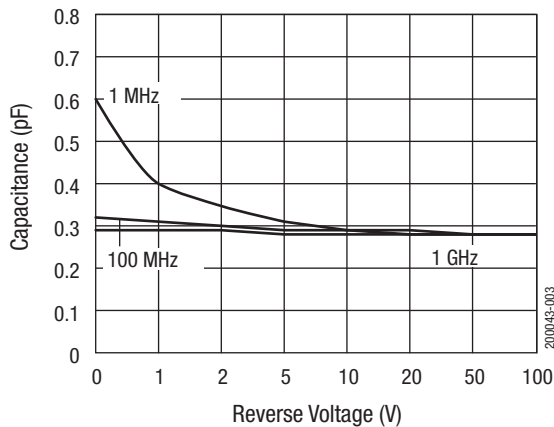

Figure 3. Capacitance vs Reverse Voltage

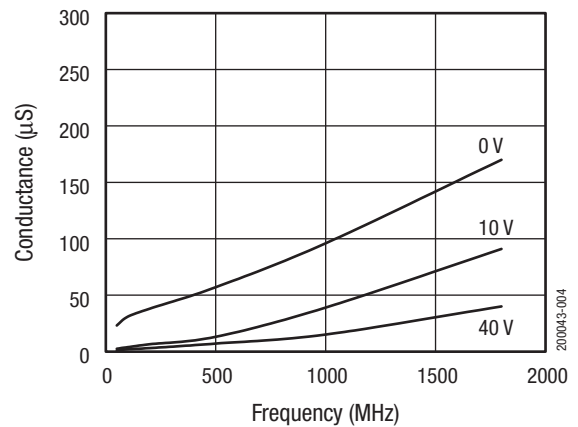

Figure 4. Conductance vs Frequency and Reverse Voltage

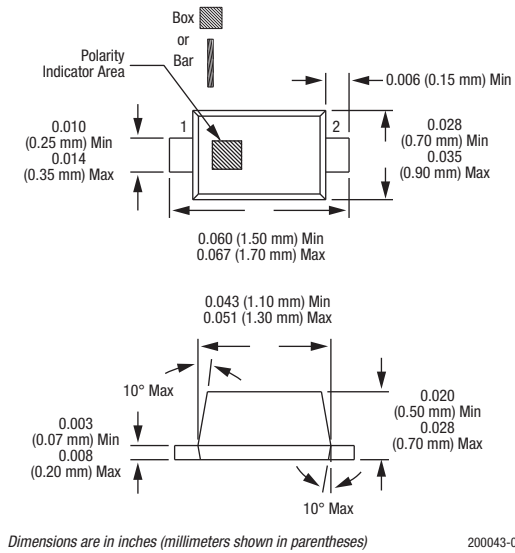

Figure 5. SC-79 Package Dimension Drawing

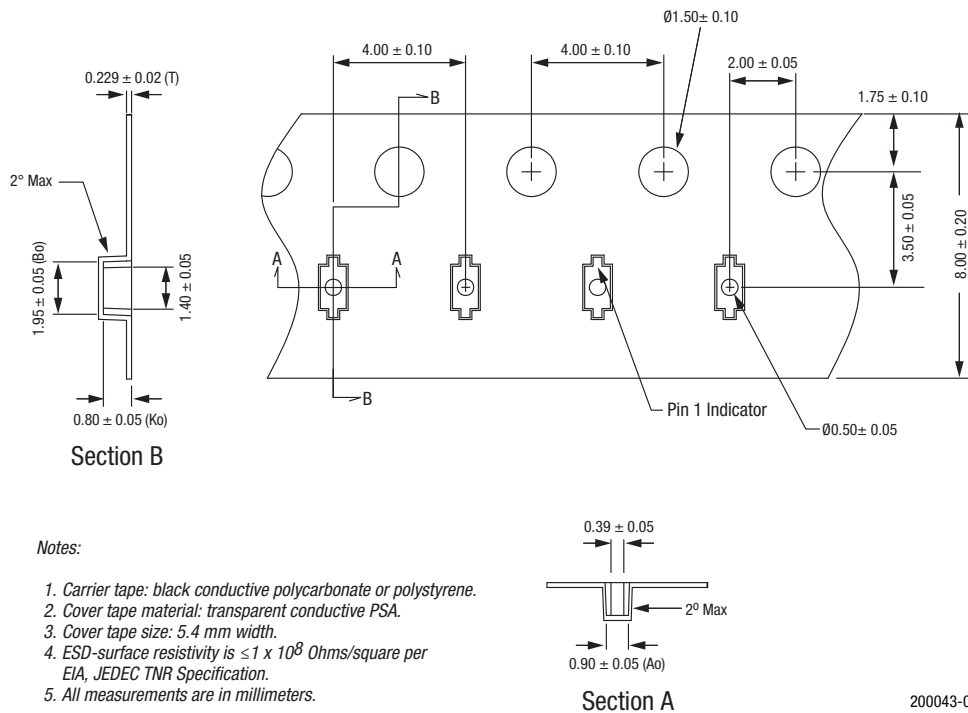

Figure 6. SC-79 Tape and Reel Dimensions

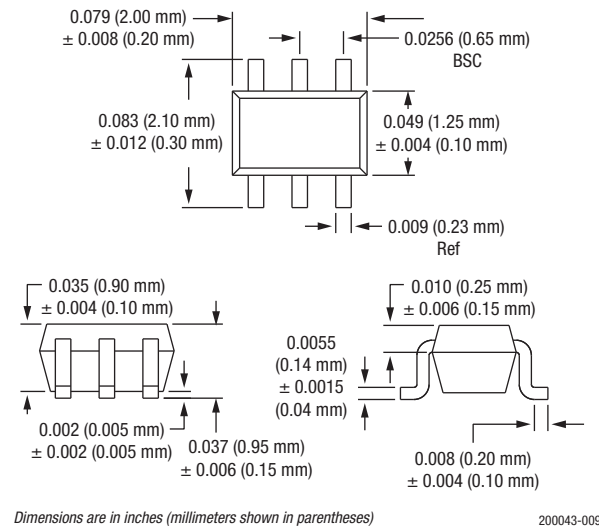

Figure 7. SC-88 Package Dimension Drawing

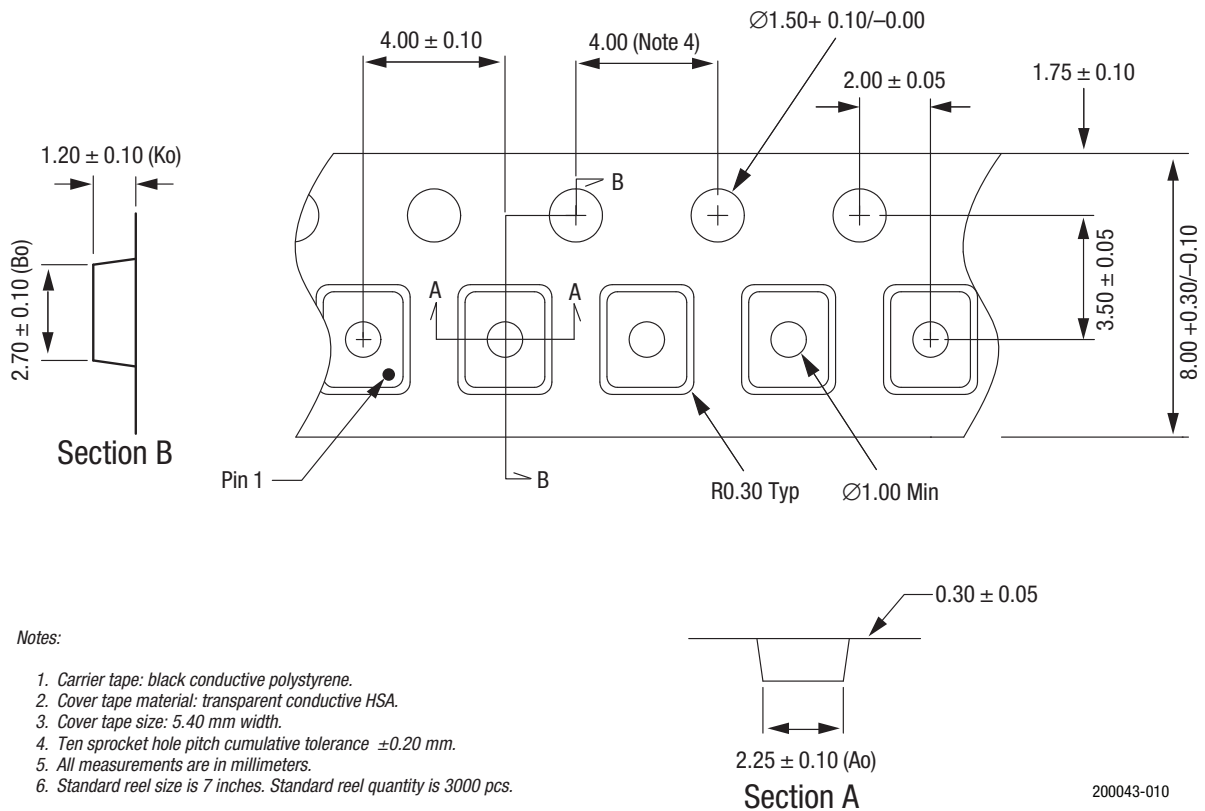
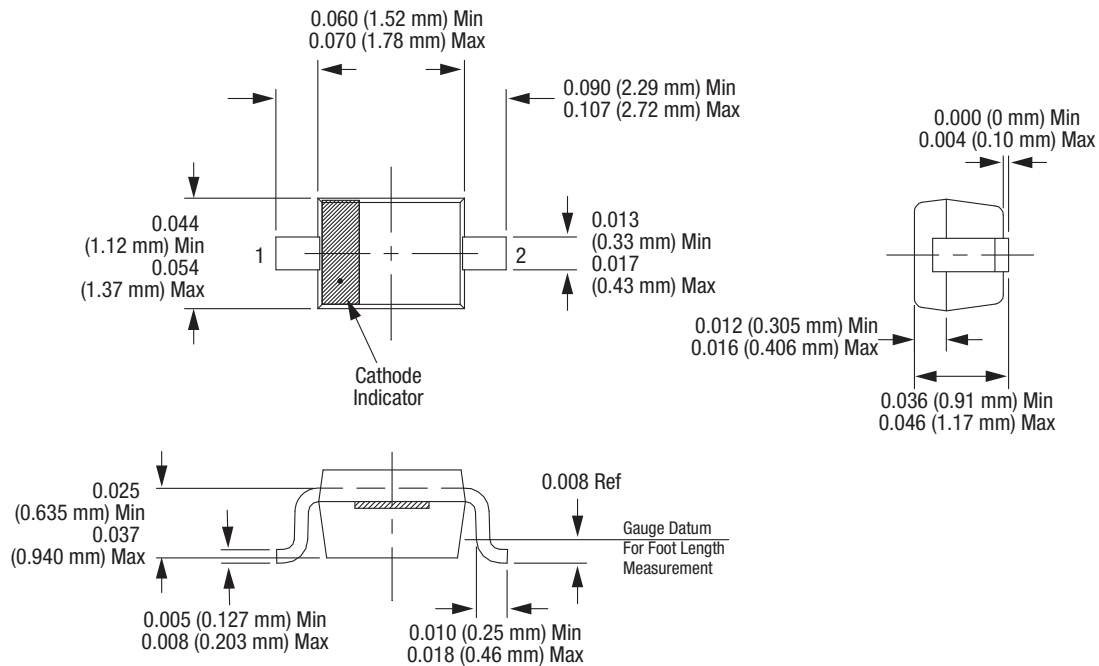

Figure 8. SC-88 Tape and Reel Dimensions



Dimensions are in inches (millimeters shown in parentheses)

200043-011

Figure 9. SOD-323 Package Dimension Drawing

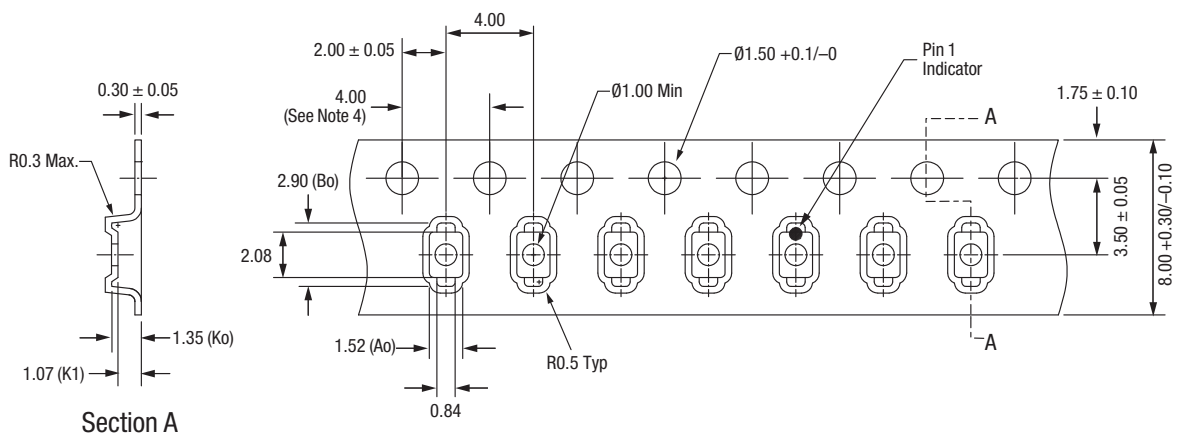

Notes:

1. Carrier tape: black conductive polystyrene.
2. Cover tape: transparent conductive PSA.
3. Cover tape size: 5.4 mm width.
4. 10 sprocket hole pitch cumulative tolerance: ± 0.20 mm.
5. All measurements are in millimeters.

200043-012

Figure 10. SOD-323 Tape and Reel Dimensions

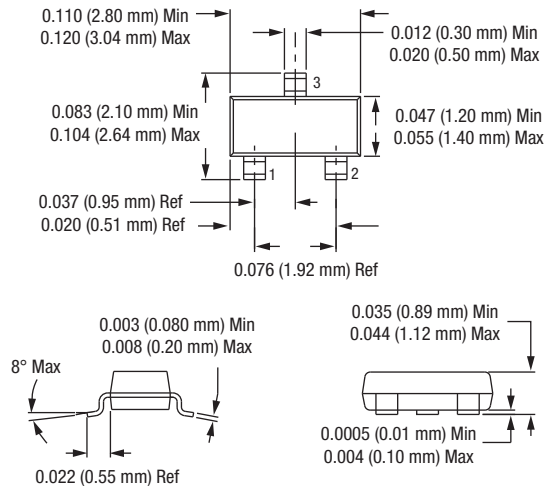

Dimensions are in inches (millimeters shown in parentheses)

200043-013

Figure 11. SOT-23 Package Dimension Drawing

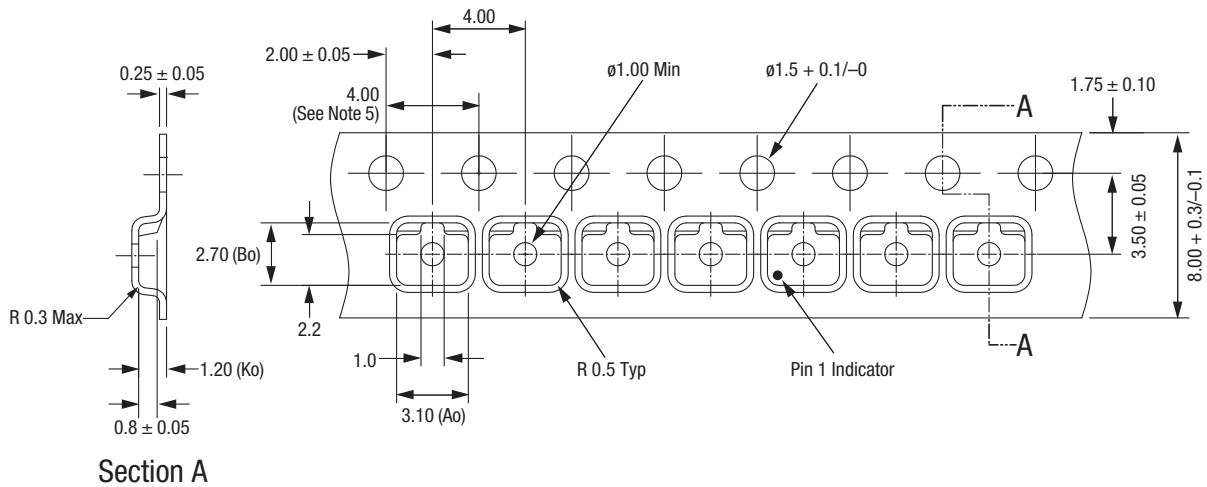

Section A

Notes:

1. Carrier tape: black conductive polycarbonate.
2. Cover tape material: transparent conductive PSA.
3. Cover tape size: 5.40 mm width.
4. Tolerance: ± 0.10 mm.
5. Ten sprocket hole pitch cumulative tolerance: ± 0.2 mm.
6. All measurements are in millimeters.
7. Alternative carrier tape dimensions are:
 $A_0 = 3.3$
 $B_0 = 2.9$
 $K_0 = 1.22$

200043-014

Figure 12. SOT-23 Tape and Reel Dimensions

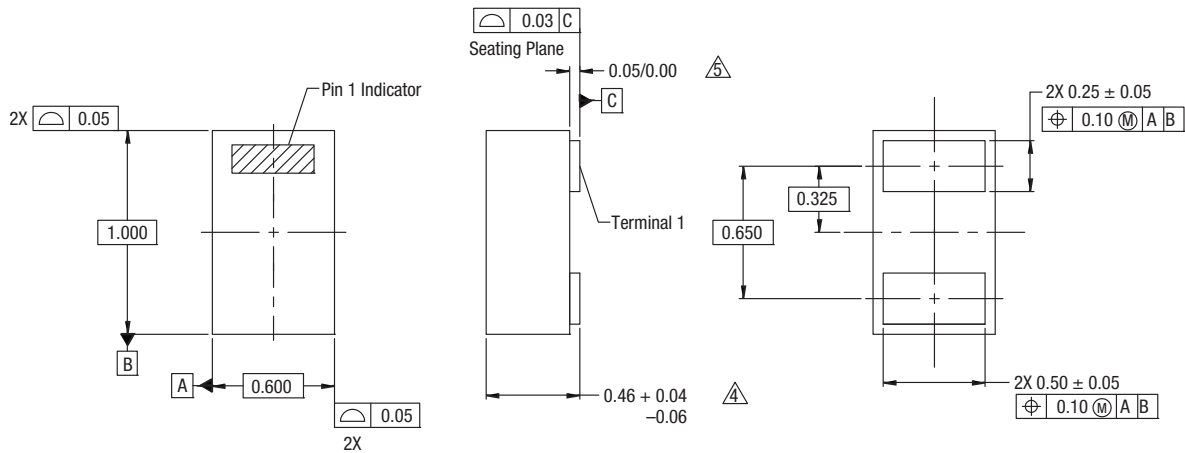

Notes:

1. All measurements are in millimeters.
2. Dimensions and tolerances according to ASME Y14.5M-1994.
3. These packages are used principally for discrete devices.
4. This dimension includes stand-off height and package body thickness, but does not include attached features, e.g., external heatsink or chip capacitors. An integral heatslug is not considered an attached feature.
5. This dimension is primarily terminal plating, but does not include small metal protrusion.

200043-015

Figure 13. SOD-882 Package Dimension Drawing

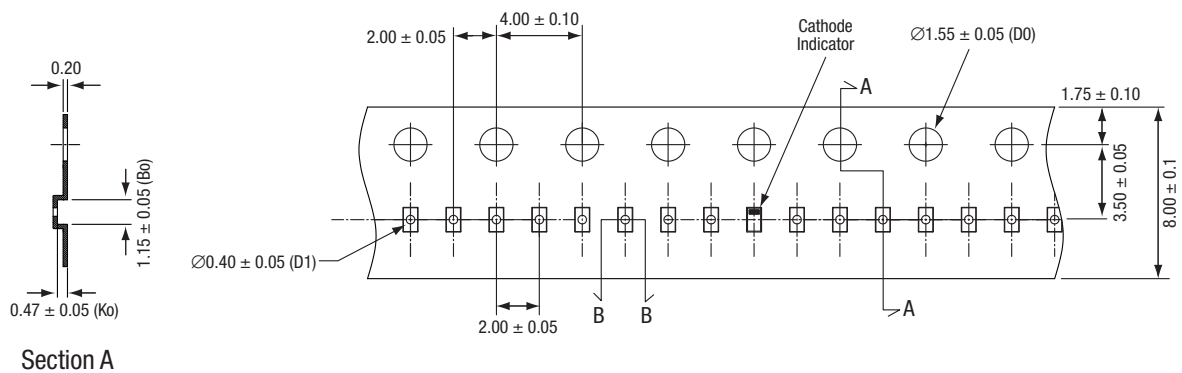

Section A

Notes:

1. Carrier tape: black conductive polycarbonate.
2. Cover tape: transparent conductive material.
3. Cover tape size: 5.4 mm width.
4. ESD surface resistivity is $\geq 1 \times 10^4 \sim \leq 1 \times 10^9$ Ohms/square.
5. All dimensions are in millimeters.

0.70 ± 0.05 (A0)



Section B

200043-016

Figure 14. SOD-882 Tape and Reel Dimensions

Copyright © 2002-2019 Skyworks Solutions, Inc. All Rights Reserved.

Information in this document is provided in connection with Skyworks Solutions, Inc. ("Skyworks") products or services. These materials, including the information contained herein, are provided by Skyworks as a service to its customers and may be used for informational purposes only by the customer. Skyworks assumes no responsibility for errors or omissions in these materials or the information contained herein. Skyworks may change its documentation, products, services, specifications or product descriptions at any time, without notice. Skyworks makes no commitment to update the materials or information and shall have no responsibility whatsoever for conflicts, incompatibilities, or other difficulties arising from any future changes.

No license, whether express, implied, by estoppel or otherwise, is granted to any intellectual property rights by this document. Skyworks assumes no liability for any materials, products or information provided hereunder, including the sale, distribution, reproduction or use of Skyworks products, information or materials, except as may be provided in Skyworks Terms and Conditions of Sale.

THE MATERIALS, PRODUCTS AND INFORMATION ARE PROVIDED "AS IS" WITHOUT WARRANTY OF ANY KIND, WHETHER EXPRESS, IMPLIED, STATUTORY, OR OTHERWISE, INCLUDING FITNESS FOR A PARTICULAR PURPOSE OR USE, MERCHANTABILITY, PERFORMANCE, QUALITY OR NON-INFRINGEMENT OF ANY INTELLECTUAL PROPERTY RIGHT; ALL SUCH WARRANTIES ARE HEREBY EXPRESSLY DISCLAIMED. SKYWORKS DOES NOT WARRANT THE ACCURACY OR COMPLETENESS OF THE INFORMATION, TEXT, GRAPHICS OR OTHER ITEMS CONTAINED WITHIN THESE MATERIALS. SKYWORKS SHALL NOT BE LIABLE FOR ANY DAMAGES, INCLUDING BUT NOT LIMITED TO ANY SPECIAL, INDIRECT, INCIDENTAL, STATUTORY, OR CONSEQUENTIAL DAMAGES, INCLUDING WITHOUT LIMITATION, LOST REVENUES OR LOST PROFITS THAT MAY RESULT FROM THE USE OF THE MATERIALS OR INFORMATION, WHETHER OR NOT THE RECIPIENT OF MATERIALS HAS BEEN ADVISED OF THE POSSIBILITY OF SUCH DAMAGE.



Skyworks products are not intended for use in medical, lifesaving or life-sustaining applications, or other equipment in which the failure of the Skyworks products could lead to personal injury, death, physical or environmental damage. Skyworks customers using or selling Skyworks products for use in such applications do so at their own risk and agree to fully indemnify Skyworks for any damages resulting from such improper use or sale.

Customers are responsible for their products and applications using Skyworks products, which may deviate from published specifications as a result of design defects, errors, or operation of products outside of published parameters or design specifications. Customers should include design and operating safeguards to minimize these and other risks. Skyworks assumes no liability for applications assistance, customer product design, or damage to any equipment resulting from the use of Skyworks products outside of stated published specifications or parameters.

Skyworks and the Skyworks symbol are trademarks or registered trademarks of Skyworks Solutions, Inc. or its subsidiaries in the United States and other countries. Third-party brands and names are for identification purposes only, and are the property of their respective owners. Additional information, including relevant terms and conditions, posted at www.skyworksinc.com, are incorporated by reference.

Looking for pricing, stock, or lifecycle information?

Click below to explore more details on WIN SOURCE:

-  [View SMP1302-003LF on WIN SOURCE](#)
-  [Skyworks Solutions Inc. Information](#)

Optimize Your Supply Chain with WIN SOURCE Solutions

-  Global Sourcing Solution
-  Obsolete Management
-  Cost Control Management
-  Shortage Management
-  Alternative Solution
-  Excess Inventory Management