



**THE DATASHEET OF  
AHK1421ICA-T1**



**S<sup>2</sup>C Controlled, Serial LED Boost Driver**

**General Description**

The AHK1421 is a highly integrated, high efficiency LED backlight solution for portable appliances including mobile phones, smartphones, PDAs, PNDs etc. The device operates from a single-cell Li-ion or polymer battery in the voltage range from 2.7V to 5.5V.

An integrated boost (step-up) converter provides up to 28V output for driving up to 6 series LEDs. In conjunction with an external current setting ballast resistor, the AHK1421 uses a single wire, S<sup>2</sup>C digital interface to adjust the output current and therefore brightness, in 32 linear steps.

The boost switching frequency operates at 1MHz to allow optimum efficiency and the smallest external L/C filtering components. Integrated protection features protects against, open circuit LEDs, short circuits and over temperature conditions.

The AHK1421 is available in a Pb-free TSOT23-6 package.

**Features**

- Input Voltage Range: 2.7 to 5.5V
- Drives up to 6 Series LEDs at 31mA
- Integrated Boost Converter
  - 1MHz Switching Frequency
  - Up to 86% Efficiency
  - Internal Compensation
- 32 Steps - S<sup>2</sup>Cwire Single Wire Interface
- Shutdown Current < 4μA
- Integrated Protection Features
  - Over-Voltage Protection for Open-LED Faults
  - Over Temperature Protection
- TSOT23-6 package

**Applications**

- White LED backlight
  - Feature phones
  - Smartphones
  - PDAs
  - PMP
  - PNDs
  - Portable DVD Players

**Typical Application**

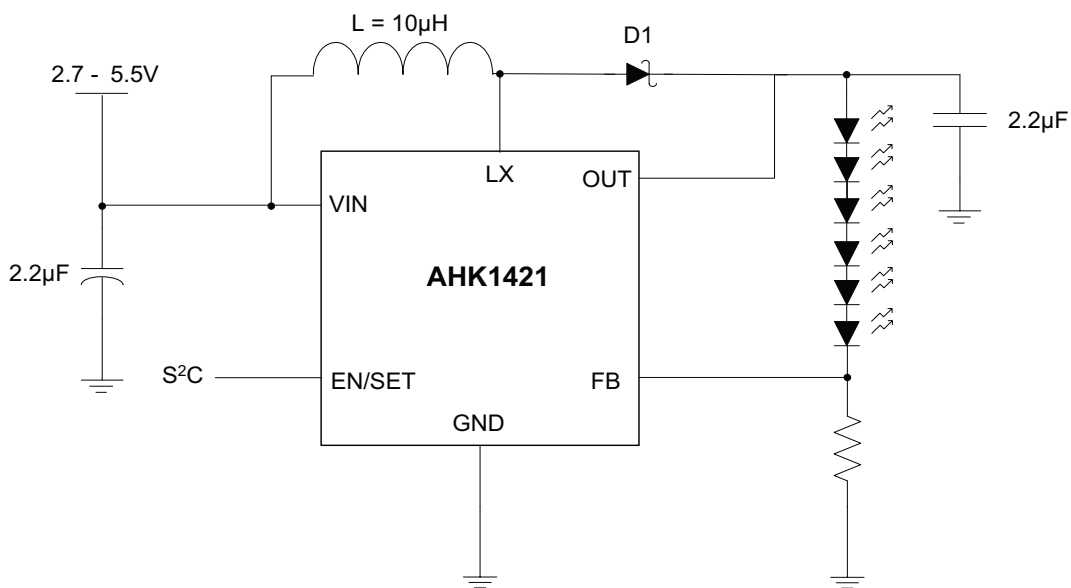

# DATA SHEET

# AHK142I

## S<sup>2</sup>C Controlled, Serial LED Boost Driver

### Pin Descriptions

Pin #	Symbol	Function	Description
1	LX	O	Switching node of boost converter. Connect a 10 $\mu$ H inductor between this pin and input voltage source.
2	GND	GND	Ground.
3	FB	I	Feedback pin from LED ballast resistor. Connect a resistor to ground to set the maximum LED current.
4	EN/SET	I	Enable on/off control and S <sup>2</sup> Cwire interface input.
5	OUT	O	Output of boost converter. Connect to the anode of the first LED in the series string.
6	VIN	I	Input voltage to IC. Tied to input voltage source and input boost inductor.

### Pin Configuration

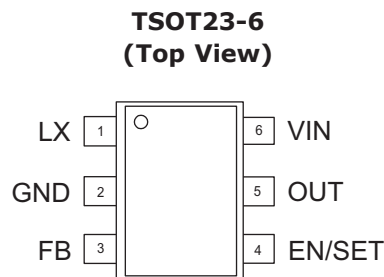

### Absolute Maximum Ratings<sup>1</sup>

Symbol	Description	Value	Units
V <sub>LX</sub> , V <sub>OUT</sub>	LX or OUT voltage to GND	28	V
V <sub>IN</sub> , V <sub>EN/SET</sub>	VIN, EN/SET to GND Voltage	-0.3 to 6	
V <sub>FB</sub>	FB to GND Voltage	-0.3 to VIN	
T <sub>J</sub>	Junction Operating Temperature	-40 to 140	°C
T <sub>LEAD</sub>	Soldering Temperature (at leads, 10 sec.)	300	

### Thermal Information<sup>2</sup>

Symbol	Description	Value	Units
Θ <sub>JA</sub>	Thermal Resistance	139	°C/W
P <sub>D</sub>	Maximum Power Dissipation	0.719	W

1. Stresses above those listed in Absolute Maximum Ratings may cause permanent damage to the device. Functional operation at conditions other than the operating conditions specified is not implied.
2. Mounted on an FR4 board.

# DATA SHEET

# AHK1421

## S<sup>2</sup>C Controlled, Serial LED Boost Driver

### Electrical Characteristics<sup>1</sup>

$V_{IN} = 3.6V$ ,  $C_{IN} = 2.2\mu F$ ,  $C_{OUT} = 2.2\mu F$ ,  $L = 10\mu H$ ,  $R_{FB} = 12.5\Omega$  ( $I_{OUT} = 20mA$ ),  $T_A = -40^\circ C$  to  $85^\circ C$  unless otherwise noted. Typical values are at  $T_A = 25^\circ C$ .

Symbol	Description	Conditions	Min	Typ	Max	Units
<b>Power Supply</b>						
$V_{IN}$	Input Voltage Range		2.7		5.5	V
$V_{UVLO}$	Under Voltage Lockout Threshold	$V_{IN}$ Rising	2.2		2.5	
		Hysteresis		300		mV
$V_{FB}$	Feedback Voltage	$I_{LED} = 20mA$	237	250	263	mV
$I_Q$	Quiescent Supply Current	No Switching, $V_{EN/SET} = 5V$		170	600	$\mu A$
$I_{IN}$	Supply Current	$V_{EN/SET} = 5V$		2.3		mA
$I_{SHDN}$	Input Shutdown Current	$V_{EN/SET} = 0V$			4.0	$\mu A$
$V_{OVP}$	Over-Voltage Protection Threshold		23	25	27	V
$R_{DS(ON)}$	On-Resistance			650	1000	m $\Omega$
$D_{MAX}$	Maximum Duty Cycle		90			%
$f_{osc}$	Oscillator Frequency	$T_A = 25^\circ C$		1.0		MHz
<b>S<sup>2</sup>C Control: EN/SET</b>						
$V_{EN/SET(L)}$	EN/SET Input Low Threshold				0.4	V
$V_{EN/SET(H)}$	EN/SET Input High Threshold		1.4			V
$I_{EN/SET}$	EN/SET Input Leakage Current	$V_{EN/SET} = 5V$ , $V_{IN} = 5V$	-1		1	$\mu A$
$t_{EN/SET(LOW)}$	EN/SET Input Low Time		0.3		75	$\mu s$
$t_{EN/SET(HI\_MIN)}$	EN/SET Minimum High Time		100			ns
$t_{EN/SET(HI\_MAX)}$	EN/SET Maximum High Time				75	$\mu s$
$t_{EN/SET(OFF)}$	EN/SET Input Off Timeout				500	$\mu s$
$t_{EN/SET(LAT)}$	EN/SET Latch Timeout				500	$\mu s$
<b>Thermal Protection</b>						
$T_{J(SD)}$	Thermal Shutdown Threshold			140		$^\circ C$
$T_{J(HYS)}$	Thermal Shutdown Hysteresis			15		$^\circ C$

1. The AHK1421 is guaranteed to meet performance specification over the  $-40^\circ C$  to  $+85^\circ C$  operating temperature range, and is assured by design, characterization and correlation with statistical process controls.

# DATA SHEET

# AHK142I

## S<sup>2</sup>C Controlled, Serial LED Boost Driver

### Shutdown Current vs Input Voltage

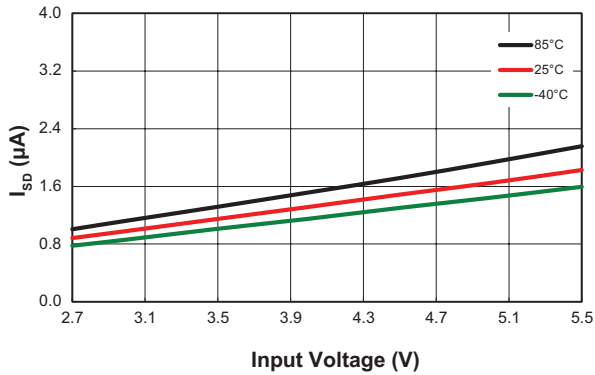

### Quiescent Current vs Input Voltage

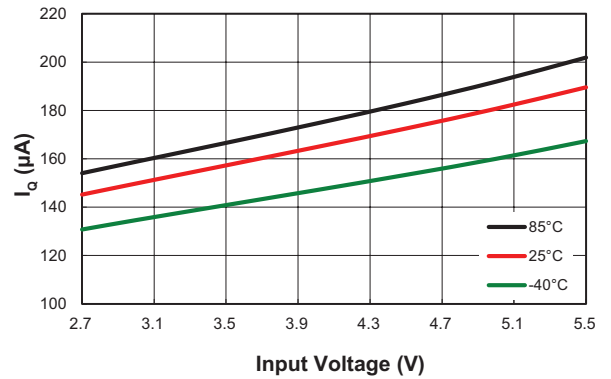

### Efficiency vs Output Current ( $R_{FB} = 8.3\Omega$ , $L = 10\mu H$ , 6LEDs)

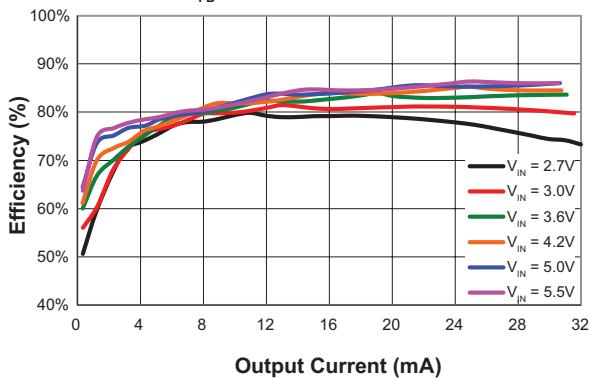

### Switching Frequency vs Temperature $V_{IN} = 3.6V$ , $R_{FB} = 12.4\Omega$ , 6LEDs

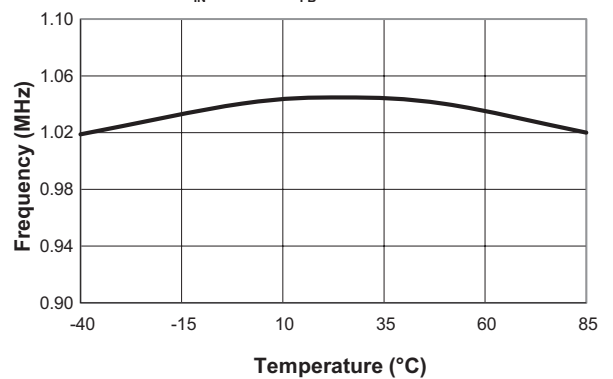

### NMOS $R_{DS(ON)}$ vs Input Voltage

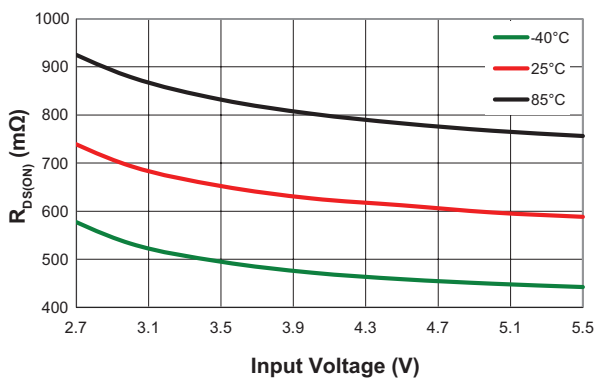

**Sink Current Accuracy vs Temperature**

$V_{IN} = 3.6V, R_{FB} = 8.3\Omega, 6 \text{ LEDs}$

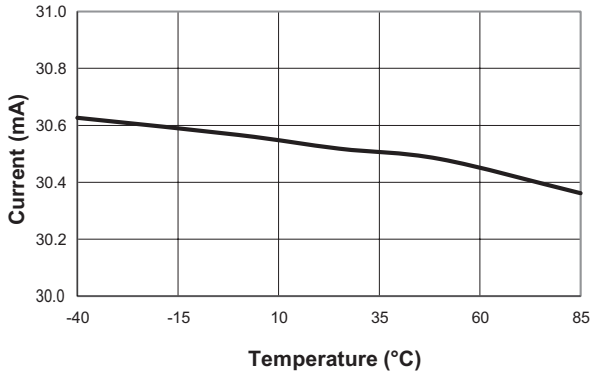

**Sink Current Accuracy vs Temperature**

$V_{IN} = 3.6V, R_{FB} = 12.4\Omega, 6 \text{ LEDs}$

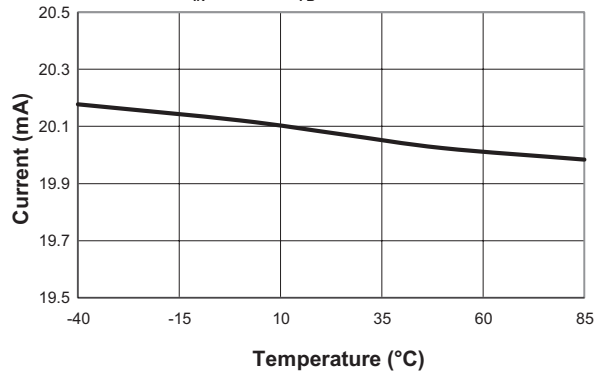

**Feedback Voltage vs Temperature**

$V_{IN} = 3.6V, R_{FB} = 12.4\Omega, 6 \text{ LEDs}$

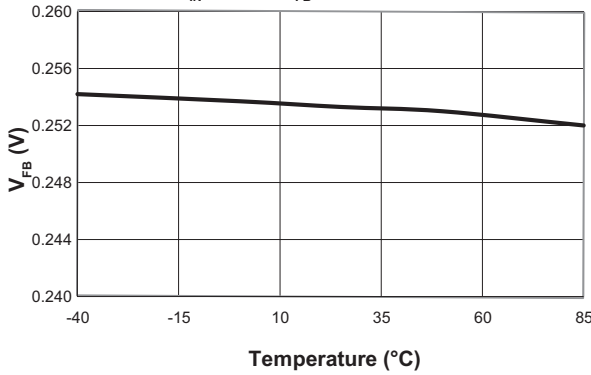

**Feedback Voltage vs Input Voltage**

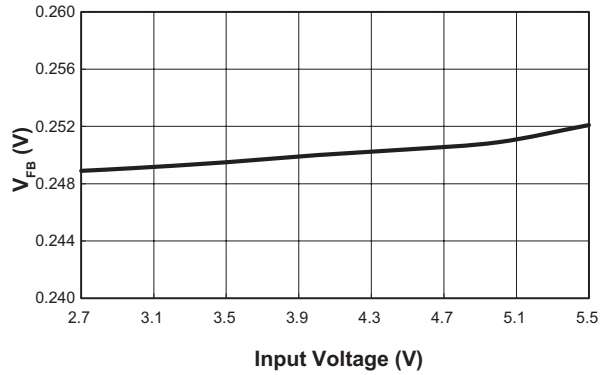

**OVP High Threshold Voltage vs Input Voltage**

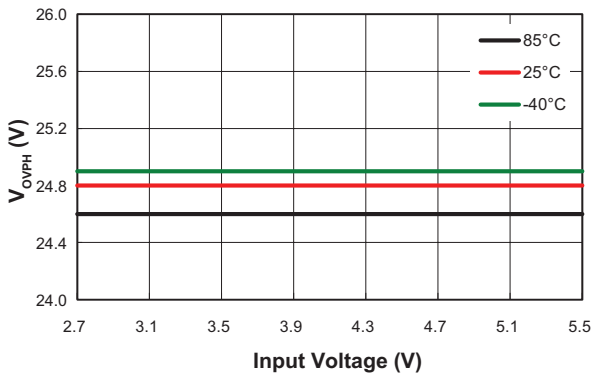

**OVP Low Threshold Voltage vs Input Voltage**

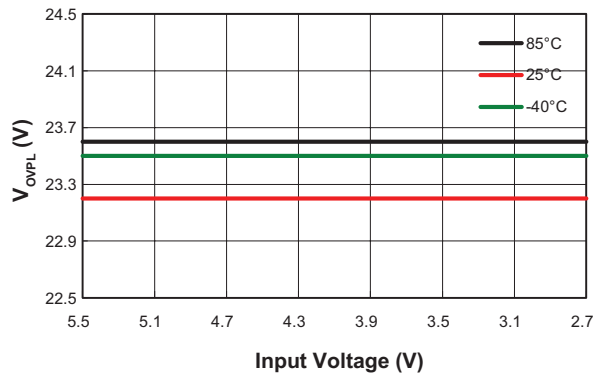

# DATA SHEET

# AHK1421

## S<sup>2</sup>C Controlled, Serial LED Boost Driver

**EN Input High/Low Threshold Voltage vs Input Voltage**

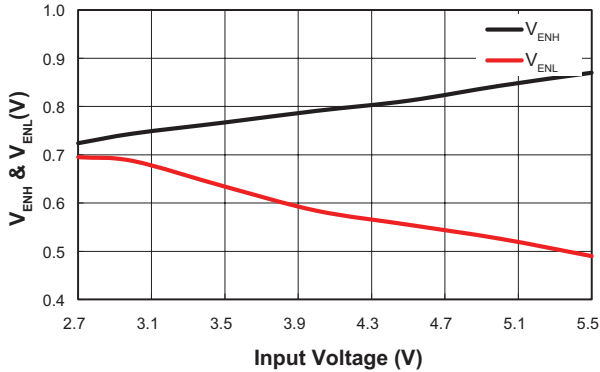

**Operation Waveform**  
(V<sub>IN</sub> = 3.6V, C<sub>IN</sub> = 4.7μF, C<sub>OUT</sub> = 2.2μF, R<sub>FB</sub> = 8.3Ω, 6 LEDs)

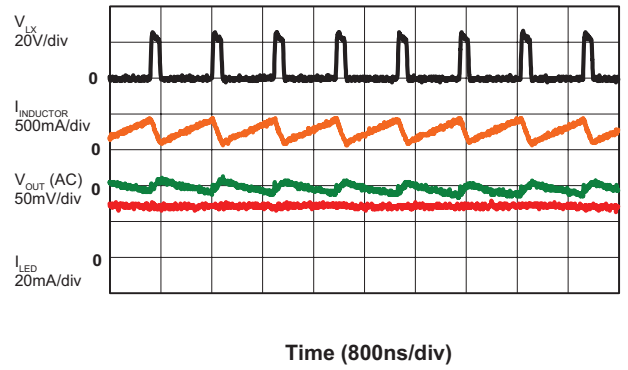

**Start Up Waveform**  
(V<sub>IN</sub> = 3.6V, C<sub>IN</sub> = 2.2μF, C<sub>OUT</sub> = 2.2μF, R<sub>FB</sub> = 8.3Ω, 6 LEDs)

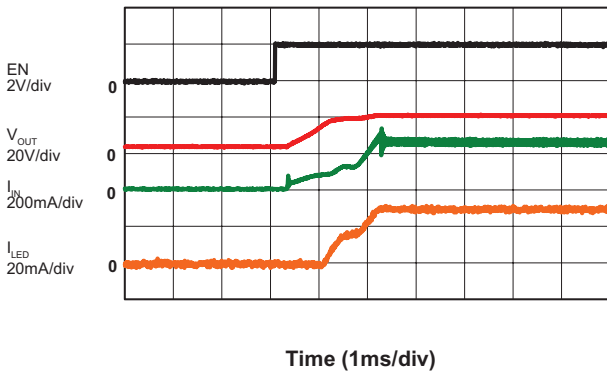

**Turn Off**  
(V<sub>IN</sub> = 3.6V, C<sub>IN</sub> = 2.2μF, C<sub>OUT</sub> = 2.2μF, R<sub>FB</sub> = 8.3Ω, 6 LEDs)

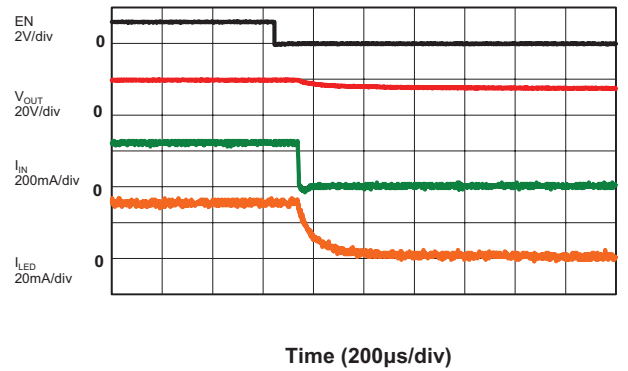

**LED Current Transient**  
(V<sub>IN</sub> = 3.6V, C<sub>IN</sub> = 2.2μF, C<sub>OUT</sub> = 2.2μF, R<sub>FB</sub> = 8.3Ω, S<sup>2</sup>C data 1 to 16, 31mA to 15mA, 6 LEDs)

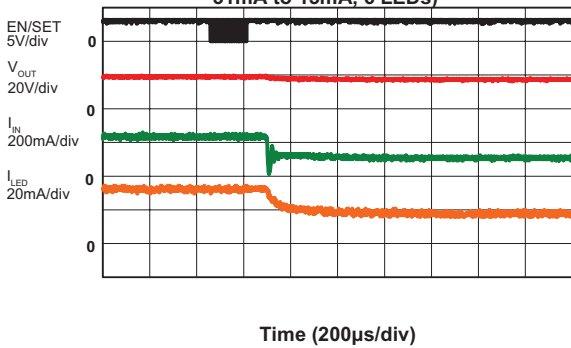

**LED Current Transient**  
(V<sub>IN</sub> = 3.6V, C<sub>IN</sub> = 2.2μF, C<sub>OUT</sub> = 2.2μF, R<sub>FB</sub> = 8.3Ω, S<sup>2</sup>C data 16 to 1, 15mA to 31mA, 6 LEDs)

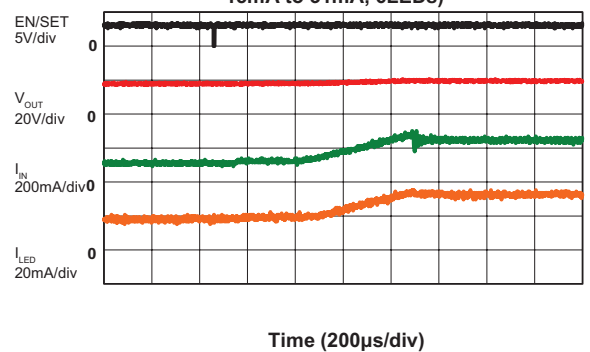

## Functional Block Diagram

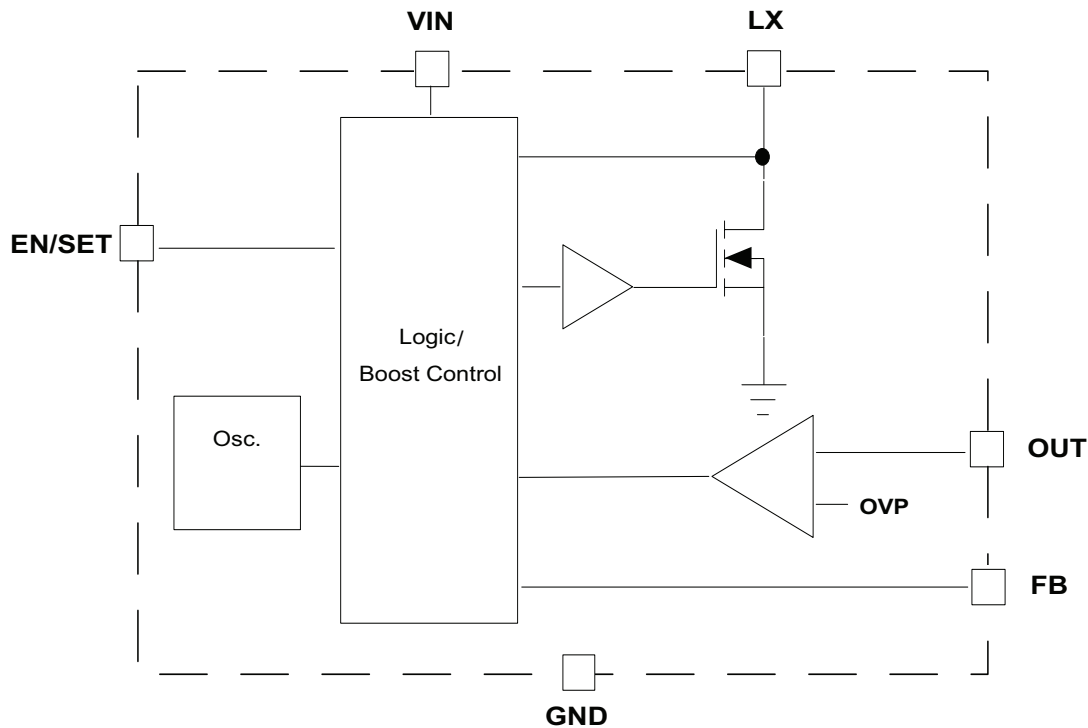

## Functional Description

The AHK1421 is a highly integrated, high efficiency white LED backlight solution for mobile phones and all battery operated equipment. The device operates from regulated DC inputs, and single-cell Li-ion batteries in the voltage range 2.7V to 4.2V.

The integrated boost (step-up) converter provides up to 28V output to drive up to 6 series LEDs. The LED current is set by a single external resistor up to 31mA. S<sup>2</sup>C single wire interface can enable and disable the IC and adjust the dimming in 32 steps.

The AHK1421 is available in a Pb-free 6-pin TSOT23 package.

The over-voltage protection function is designed to protect the boost converter during the fault of the open circuit of the LED string. The over-temperature function is targeted to protect the converter if an over-temperature fault occurs.

## Soft Start / Enable

The AHK1421 is enabled by EN/SET pulled to high after power on with a certain delay time. Internal soft start circuitry limits the input inrush current and eliminates output voltage overshoot. When EN/SET is pulled low, the AHK1421 enters a low-power, non-switching state. The total input current during shutdown is less than 4 $\mu$ A.

## Over-Temperature Protection

Thermal protection disables the AHK1421 when internal dissipation becomes excessive. Thermal protection disables the power MOSFET. The junction over-temperature threshold is 140°C with 15°C of temperature hysteresis. The output voltage automatically recovers when the over-temperature fault condition is removed.

## Over-Voltage Protection

Over-voltage protection prevents damage to the AHK1421's pin during LED open-circuit or high output voltage conditions. An over-voltage event is defined as a condition where the voltage on the OUT pin exceeds the over-voltage protection threshold ( $V_{OVP}$ ). When  $V_{OVP}$  has

## S<sup>2</sup>C Controlled, Serial LED Boost Driver

reached the threshold limit, the converter stops switching and the output voltage decays. Switching resumes when the lower hysteresis limit of  $V_{OVP}$  is reached, thereby maintaining an average output voltage between the upper and lower OVP thresholds.

### LED Current Setting

The maximum LED current is determined by the  $R_{FB}$  resistor value. With a fixed 0.25V voltage on  $R_{FB}$ , the LED maximum current is a linear ratio to the current flowing through  $R_{FB}$ .

$$I_{LED} = \frac{V_{FB}}{R_{FB}}$$

Where  $V_{FB} = 0.25V$

Table 1 lists examples of calculated  $R_{FB}$  resistor values for different maximum LED current requirements. Higher accuracy  $R_{FB}$  resistor can get higher accurate LED current.

Maximum LED Current (mA)	$R_{FB}$ ( $\Omega$ )
31	8.06
30	8.33
20	12.5
15	16.66
12	20.83
10	25

**Table 1: Examples of  $R_{FB}$  Values for Setting Maximum LED Current Levels.**

The LED dimming is controlled in 32-steps using the S<sup>2</sup>Cwire single-wire interface via the EN/SET pin. 32 S<sup>2</sup>Cwire rising-edge steps set the LED current from 100% to 2% of the maximum LED current.

### S<sup>2</sup>Cwire Serial Interface Timing

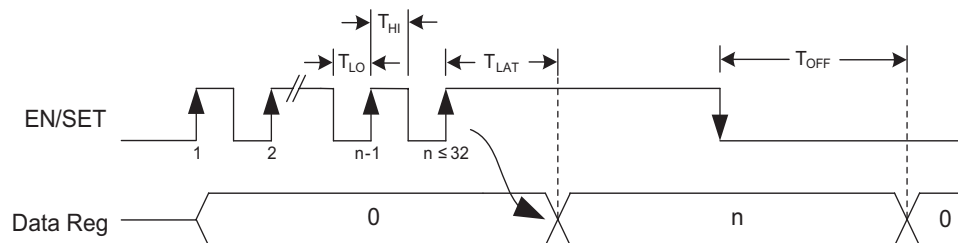

**Figure 1: S<sup>2</sup>Cwire Timing Diagram.**

### S<sup>2</sup>Cwire™ Serial Interface

The LED current magnitude can be controlled by the EN/SET pin using the S<sup>2</sup>Cwire interface. The interface records rising edges of the EN/SET pin and decodes them into 32 individual current level settings. Code 1 is full scale (maximum LED current), and Code 32 is 2% of the full scale. The modulo 32 interface wraps states back to state 1 after the 32nd clock. The counter can be clocked at speeds up to 1MHz, so intermediate states are not visible. The first rising edge of EN/SET enables the IC and initially sets the output LED current to full scale after  $500\mu s$   $t_{LAT}$ . Once the final clock cycle is input for the desired brightness level, the EN/SET pin should be held high to maintain the device output current at the programmed level. The device is disabled  $500\mu s$  after the EN/SET pin enters a logic low state. The EN/SET timing is designed to accommodate a wide range of data rates from 20kHz to 1MHz.

After the first rising edge of EN/SET, the boost converter is enabled and reaches full capacity after the soft-start time. Exact counts of clock pulses for the desired current level should be entered on the EN/SET pin with a single burst of clocks. The counter refreshes each time a new clock input to the EN/SET pin is detected. A constant current is maintained as long as EN/SET remains in a logic high state. To save power, the boost converter is switched off after EN/SET has remained in the low state for at least the  $t_{OFF}$  timeout period as shown in Figure 1.

## S<sup>2</sup>C Controlled, Serial LED Boost Driver

### Application Information

#### LED Current Setting

LED current dimming is controlled via the S<sup>2</sup>Cwire single-wire interface through the EN/SET pin in 32 steps. The S<sup>2</sup>Cwire interface programs the LED current from the maximum LED current set by R<sub>FB</sub> to 2% of the maximum LED current as shown in Table 2.

S <sup>2</sup> Cwire Data	LED Current (% I <sub>MAX</sub> )	S <sup>2</sup> Cwire Data	LED Current (% I <sub>MAX</sub> )
1	100	17	48
2	97	18	45
3	94	19	42
4	90	20	39
5	87	21	35
6	84	22	32
7	81	23	29
8	77	24	26
9	74	25	23
10	71	26	19
11	68	27	16
12	65	28	13
13	61	29	10
14	58	30	6
15	55	31	3
16	52	32	2

**Table 2: S<sup>2</sup>Cwire Dimming Control Current Settings.**

#### Capacitor Selection

A 2.2μF/10V input capacitor is recommended and a 2.2μF/50V output capacitor is suitable as noted above. Multi-layer ceramic (MLC) capacitors provide small size and adequate capacitance, low parasitic equivalent series resistance (ESR) and equivalent series inductance (ESL), and are well suited for use as input, output and compensation capacitors in the AHK1421 step-up con-

verter LED driver application. MLC capacitors of type X7R or X5R are recommended to ensure good capacitance stability over the full operating temperature range. Table 3 lists some recommended capacitors for use with the AHK1421.

#### Inductor Selection

Inductor value, saturation current and DCR is most important parameter in selecting an inductor for AHK1421. The suitable inductance range for the AHK1421 is 4.7μH to 22μH. Higher inductance lowers the step-up converter's RMS current value. Together with lower DCR value of the inductor, it makes the total inductor power loss become much lower. Considering inductor size and cost, 10μH inductance is most suitable.

Inductor saturation current is a key parameter in selecting an inductor. For the step-up converter, the peak inductor current is the DC input current plus half the inductor peak-to-peak current ripple.

DC input current is given by:

$$I_{IN} = \frac{V_{OUT} \cdot I_{LED}}{V_{IN} \cdot \eta}$$

Inductor peak-to-peak current ripple:

$$I_{L\_PP} = \frac{V_{IN} \cdot (V_{OUT} - V_{IN})}{V_{OUT} \cdot L \cdot f}$$

Inductor peak current:

$$I_{L\_PEAK} = I_{IN} + \frac{I_{L\_PP}}{2} = \frac{V_{OUT} \cdot I_{LED}}{V_{IN} \cdot \eta} + \frac{V_{IN} \cdot (V_{OUT} - V_{IN})}{2 \cdot V_{OUT} \cdot L \cdot f}$$

For example, for a white LED with 3.2V V<sub>F</sub> and 20mA current at 82% efficiency, the inductor peak current for 6LEDs in a string is:

$$I_{L\_PEAK} = \frac{3.2 \cdot 6 \cdot 0.02}{3.6 \cdot 0.82} + \frac{3.6 \cdot (3.2 \cdot 6 - 3.6)}{2 \cdot 3.2 \cdot 6 \cdot 10\mu \cdot 1M} = 276mA$$

Manufacturer	Part Number	Value (μF)	Voltage (V)	Temperature Range	Case Size
Murata	GRM188R61A225K	2.2	10	X5R	0603
	GRM31CR71H225K	2.2	50	X7R	1206

**Table 3: Examples of AHK1421 Input and Output Capacitor Selection.**

***S<sup>2</sup>C Controlled, Serial LED Boost Driver***

For the inductor copper loss, the inductor DCR value together with the RMS current value flowing through the inductor leads to inductor conduction loss and also affects total efficiency. Larger DCR leads to larger conduction loss and decreases total efficiency. The inductor conduction loss can be estimated as shown in the equation:

$$P_{L\_LOSS} = I_{L\_RMS}^2 \cdot DCR$$
$$= \frac{1}{3} \cdot (I_{L\_MAX}^2 + I_{L\_MIN}^2 + I_{L\_MAX} \cdot I_{L\_MIN}) \cdot DCR$$

$I_{L\_MAX}$  and  $I_{L\_MIN}$  are the inductor peak current and minimum current.

Table 4 gives some examples of recommended inductors for use with the AHK1421.

**Schottky Diode Selection**

To achieve maximum efficiency, a low  $V_F$  Schottky diode is recommended. The diode voltage rating should be higher than the OVP voltage. For an AHK1421 driving 6 white LEDs with up to 4V forward voltage, the diode voltage rating should be higher than 24V. Select a diode with DC rated current equal to the input current to allow an adequate margin for safe use. Table 5 gives some examples of recommended Schottky diodes for use with the AHK1421.

# DATA SHEET

# AHK1421

## S<sup>2</sup>C Controlled, Serial LED Boost Driver

Manufacturer	Part Number	Inductance (μH)	Maximum DC ISAT Current (mA)	DCR (mΩ, typ)	Size (mm) LxWxH	Type
Sumida	CDRH2D14-100	10	700	294	3.2x3.2x1.55	Shielded
Murata	LQH3NPN100NM0	10	870	260	3.0x3.0x1.4	Non-shielded
	LQH3NPN100NG0	10	630	570	3.0x3.0x0.9	Non-shielded
Coilcraft	EPL2014-103MLC	10	600	440	2.1x2.2x1.0	Shielded

**Table 4: Example of AHK1421 Inductor Selection**

Manufacturer	Part Number	Maximum DC Blocking Voltage V <sub>R</sub> (V)	Maximum DC Forward Current I <sub>F</sub> (mA)	Non-repetitive Peak Forward Surge Current I <sub>FSM</sub> (A)	Forward Voltage V <sub>F</sub> (V)	Case	"Size WxLxH (mm)"
TSC	SS13L	30	1100	30	0.51@0.5A	Sub SMA	1.9x3.8x1.43
	SS14L	40	1100	30	0.51@0.5A	Sub SMA	1.9x3.8x1.43
Diodes	SDM20U40	40	250	1	0.37@20mA	SOD523	0.9x1.7x0.65
	SD103BW	30	350	1.5	0.37@20mA	SOD123	1.7x3.85x1.35
Central	CMDSH2-3	30	200	1	0.32@15mA	SDD323	1.35x2.6x1.0

**Table 5: Example of AHK1421 Schottky Diode Selection**

## S<sup>2</sup>C Controlled, Serial LED Boost Driver

### Printed Circuit Board Layout Recommendations

For best performance of the AHK1421, the following guidelines should be followed when designing the PCB layout:

1. Make the power trace as short and wide as possible, including the input/output power lines and switching node, etc.

2. Make sure the ground bump connected to the printed circuit board with large copper area for better thermal dissipation.
3. Put the input and output capacitor close to the IC as close as possible to get the best filter result.

### Schematic and Layout

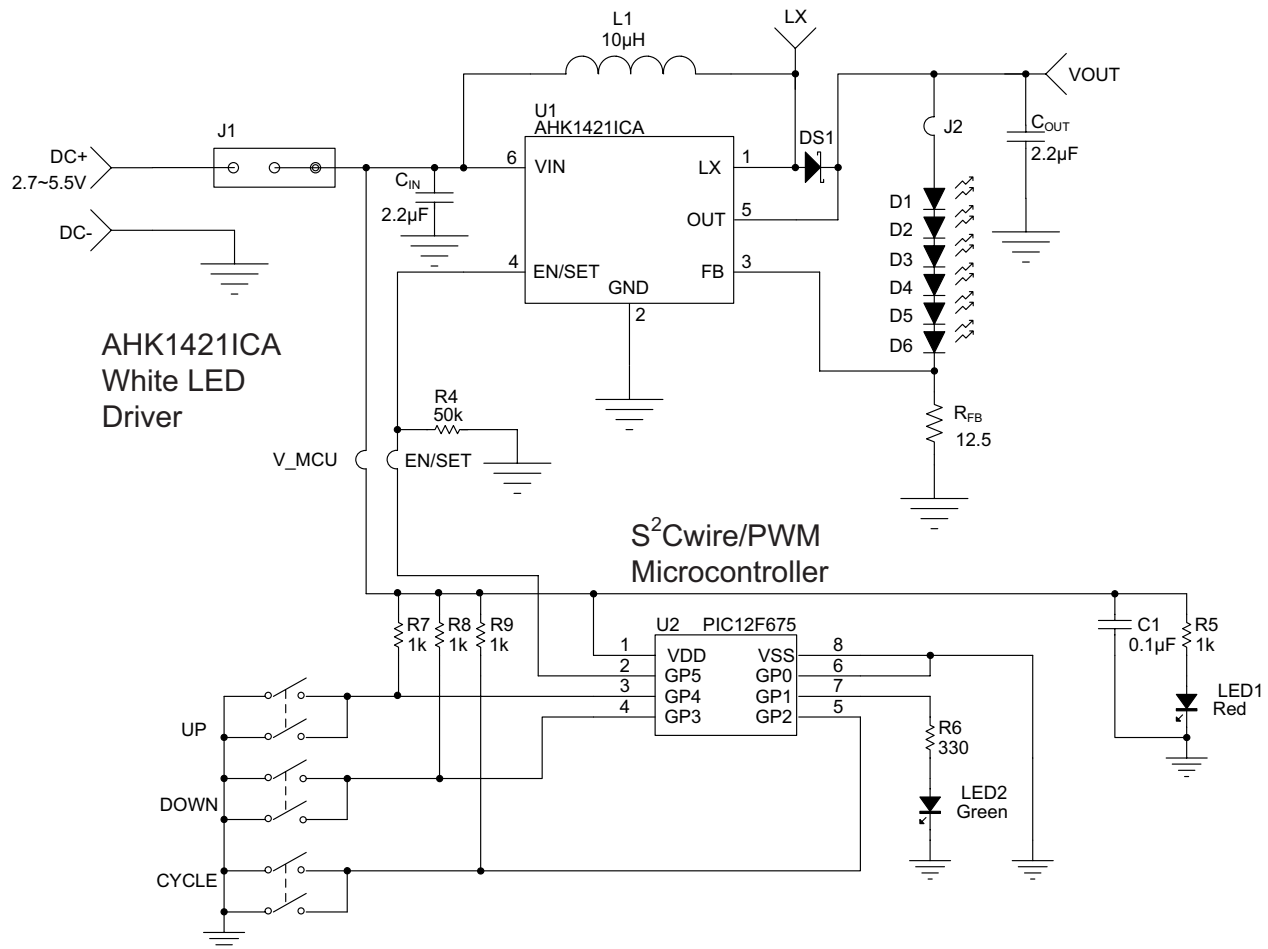

**Figure 2: AHK1421 ICA Evaluation Board Schematic.**

# DATA SHEET

# AHK1421

## S<sup>2</sup>C Controlled, Serial LED Boost Driver

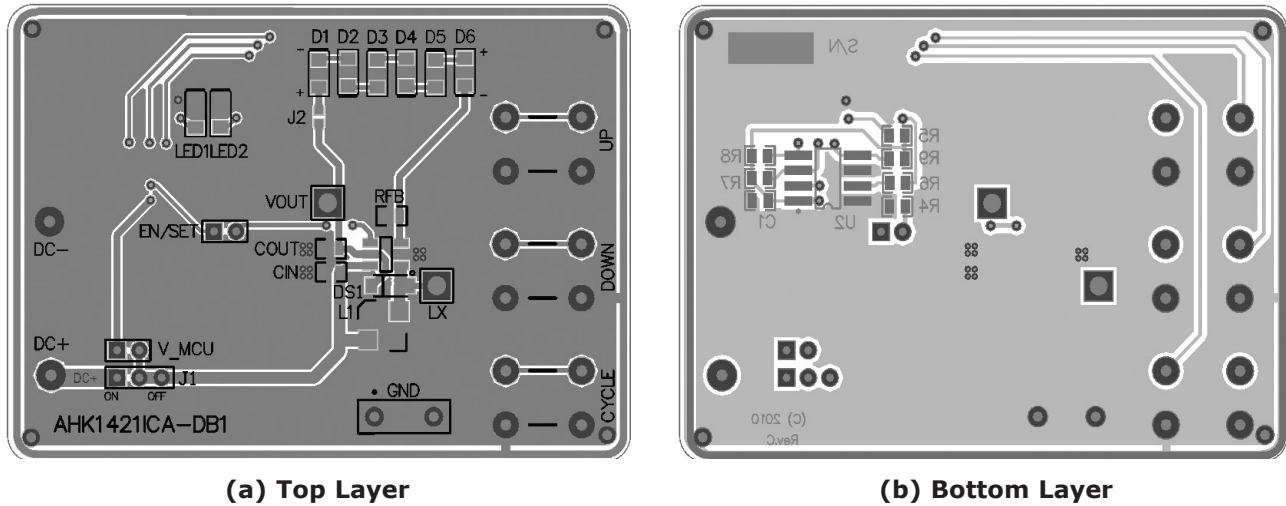

Figure 3: AHK1421ICA Evaluation Board

Component	Part Number	Description	Manufacturer
U1	AHK1421	S2C controlled, serial LED boost driver IC, TSOT23-6	Skyworks
U2	PIC12F675	8-bit CMOS, FLASH-based uC; SOIC-8	Microchip
C1	GRM188R71H104KA01	0.1μF, 50V, X7R, 0603	Murata
CIN, COUT	GRM31CR71H225K	2.2μF, 50V, X7R, 1206	Murata
S1-S3	PTS645TL50	Switch Tact, SPST, 5mm	ITT Industries
D1, D2, D3, D4, D5, D6	RS-0805UW	30mA White LED 0805	Realstar
DS1	SS14L	Schottky Diode	TSC
L1	CDRH3D18-100NC	Power Inductor 10μH 0.9A SMD	Sumida
LED1	CMD15-21SRC/TR8	Red LED; 1206	Chicago Miniature Lamp
LED2	CMD15-21UGC/TR8	Green LED; 1206	Chicago Miniature Lamp
R4	Chip Resistor	50kΩ, 1%, 1/4W; 0603	Vishay
R5, R7, R8, R9	Chip Resistor	1kΩ, 1%, 1/4W; 0603	Vishay
R6	Chip Resistor	330Ω, 1%, 1/4W; 0603	Vishay
RFB	Chip Resistor	12.5Ω, 1%, 1/4W; 0603	Vishay

Table 6: AHK1421ICA Evaluation Board BOM List

## Ordering Information

Package	Marking <sup>1</sup>	Part Number (Tape and Reel) <sup>2</sup>
TSOT23-6	T7XYY	<b>AHK1421ICA-T1</b>



Skyworks Green™ products are compliant with all applicable legislation and are halogen-free.

For additional information, refer to *Skyworks Definition of Green™*, document number SQ04-0074.

## Package Information

### TSOT23-6

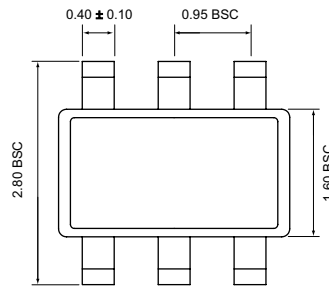

Top View

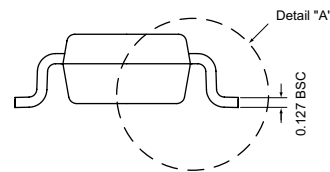

End View

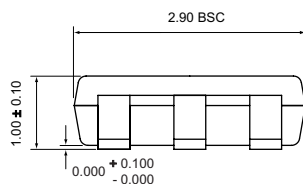

Side View

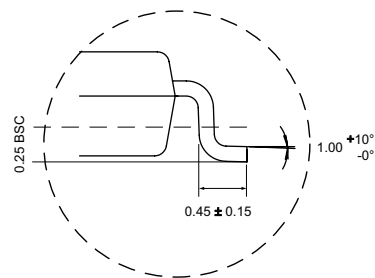

Detail "A"

1. XYY = assembly and date code.
2. Sample stock is generally held on part numbers listed in **BOLD**.

# DATA SHEET

# AHK1421

## S<sup>2</sup>C Controlled, Serial LED Boost Driver

Copyright © 2012 Skyworks Solutions, Inc. All Rights Reserved.

Information in this document is provided in connection with Skyworks Solutions, Inc. ("Skyworks") products or services. These materials, including the information contained herein, are provided by Skyworks as a service to its customers and may be used for informational purposes only by the customer. Skyworks assumes no responsibility for errors or omissions in these materials or the information contained herein. Skyworks may change its documentation, products, services, specifications or product descriptions at any time, without notice. Skyworks makes no commitment to update the materials or information and shall have no responsibility whatsoever for conflicts, incompatibilities, or other difficulties arising from any future changes.

No license, whether express, implied, by estoppel or otherwise, is granted to any intellectual property rights by this document. Skyworks assumes no liability for any materials, products or information provided hereunder, including the sale, distribution, reproduction or use of Skyworks products, information or materials, except as may be provided in Skyworks Terms and Conditions of Sale.

THE MATERIALS, PRODUCTS AND INFORMATION ARE PROVIDED "AS IS" WITHOUT WARRANTY OF ANY KIND, WHETHER EXPRESS, IMPLIED, STATUTORY, OR OTHERWISE, INCLUDING FITNESS FOR A PARTICULAR PURPOSE OR USE, MERCHANTABILITY, PERFORMANCE, QUALITY OR NON-INFRINGEMENT OF ANY INTELLECTUAL PROPERTY RIGHT; ALL SUCH WARRANTIES ARE HEREBY EXPRESSLY DISCLAIMED. SKYWORKS DOES NOT WARRANT THE ACCURACY OR COMPLETENESS OF THE INFORMATION, TEXT, GRAPHICS OR OTHER ITEMS CONTAINED WITHIN THESE MATERIALS. SKYWORKS SHALL NOT BE LIABLE FOR ANY DAMAGES, INCLUDING BUT NOT LIMITED TO ANY SPECIAL, INDIRECT, INCIDENTAL, STATUTORY, OR CONSEQUENTIAL DAMAGES, INCLUDING WITHOUT LIMITATION, LOST REVENUES OR LOST PROFITS THAT MAY RESULT FROM THE USE OF THE MATERIALS OR INFORMATION, WHETHER OR NOT THE RECIPIENT OF MATERIALS HAS BEEN ADVISED OF THE POSSIBILITY OF SUCH DAMAGE.



Skyworks products are not intended for use in medical, lifesaving or life-sustaining applications, or other equipment in which the failure of the Skyworks products could lead to personal injury, death, physical or environmental damage. Skyworks customers using or selling Skyworks products for use in such applications do so at their own risk and agree to fully indemnify Skyworks for any damages resulting from such improper use or sale.

Customers are responsible for their products and applications using Skyworks products, which may deviate from published specifications as a result of design defects, errors, or operation of products outside of published parameters or design specifications. Customers should include design and operating safeguards to minimize these and other risks. Skyworks assumes no liability for applications assistance, customer product design, or damage to any equipment resulting from the use of Skyworks products outside of stated published specifications or parameters.

Skyworks, the Skyworks symbol, and "Breakthrough Simplicity" are trademarks or registered trademarks of Skyworks Solutions, Inc., in the United States and other countries. Third-party brands and names are for identification purposes only, and are the property of their respective owners. Additional information, including relevant terms and conditions, posted at [www.skyworksinc.com](http://www.skyworksinc.com), are incorporated by reference.

## Looking for pricing, stock, or lifecycle information?

Click below to explore more details on WIN SOURCE:

-  [View AHK1421ICA-T1 on WIN SOURCE](#)
-  [Skyworks Solutions Inc. Information](#)

## Optimize Your Supply Chain with WIN SOURCE Solutions

-  Global Sourcing Solution
-  Obsolete Management
-  Cost Control Management
-  Shortage Management
-  Alternative Solution
-  Excess Inventory Management