



**THE DATASHEET OF
MSA-0236-TR1G**



MSA-0236

Cascadable Silicon Bipolar MMIC Amplifier



Data Sheet

Description

The MSA-0236 is a high performance silicon bipolar Monolithic Microwave Integrated Circuit (MMIC) housed in a cost effective, microstrip package. This MMIC is designed for use as a general purpose 50Ω gain block. Typical applications include narrow and broad band IF and RF amplifiers in industrial and military applications.

The MSA-series is fabricated using Avago's 10 GHz f_T , 25 GHz f_{MAX} , silicon bipolar MMIC process which uses nitride self-alignment, ion implantation, and gold metallization to achieve excellent performance, uniformity and reliability. The use of an external bias resistor for temperature and current stability also allows bias flexibility.

Features

- Cascadable 50 Ω Gain Block
- 3 dB Bandwidth: DC to 2.7 GHz
- 12.0 dB Typical Gain at 1.0 GHz
- Unconditionally Stable ($k > 1$)
- Cost Effective Ceramic Microstrip Package

36 micro-X Package

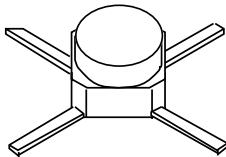

Typical Biasing Configuration

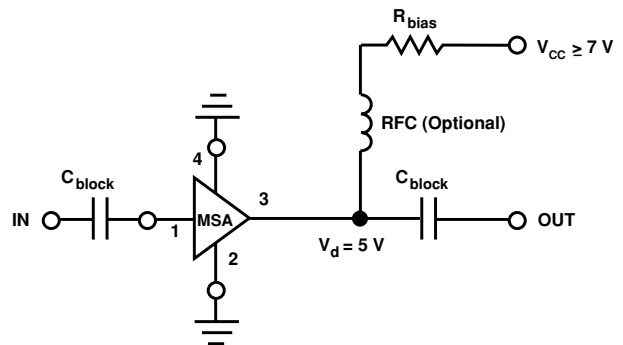

MSA-0236 Absolute Maximum Ratings

Parameter	Absolute Maximum ^[1]
Device Current	60 mA
Power Dissipation ^[2,3]	325 mW
RF Input Power	+13 dBm
Junction Temperature	150°C
Storage Temperature ^[4]	-65 to 150°C

Thermal Resistance^{[2,5]:}

$$\theta_{jc} = 145^{\circ}\text{C}/\text{W}$$

Notes:

1. Permanent damage may occur if any of these limits are exceeded.
2. $T_{\text{CASE}} = 25^{\circ}\text{C}$.
3. Derate at 6.9 mW/°C for $T_{\text{C}} > 153^{\circ}\text{C}$.
4. Storage above +150°C may tarnish the leads of this package making it difficult to solder into a circuit.
5. The small spot size of this technique results in a higher, though more accurate determination of θ_{jc} than do alternate methods.

Electrical Specifications^[1], $T_{\text{A}} = 25^{\circ}\text{C}$

Symbol	Parameters and Test Conditions: $I_{\text{d}} = 25 \text{ mA}$, $Z_{\text{o}} = 50 \Omega$	Units	Min.	Typ.	Max.
G_{P}	Power Gain ($ S_{21} ^2$) $f = 0.1 \text{ GHz}$	dB	11.5	12.5	13.5
ΔG_{P}	Gain Flatness $f = 0.1 \text{ to } 1.6 \text{ GHz}$	dB		± 0.6	± 1.0
$f_{3 \text{ dB}}$	3 dB Bandwidth	GHz		2.7	
VSWR	Input VSWR $f = 0.1 \text{ to } 3.0 \text{ GHz}$			1.2:1	
	Output VSWR $f = 0.1 \text{ to } 3.0 \text{ GHz}$			1.4:1	
NF	50 Ω Noise Figure $f = 1.0 \text{ GHz}$	dB		6.5	
$P_{1 \text{ dB}}$	Output Power at 1 dB Gain Compression $f = 1.0 \text{ GHz}$	dBm		4.5	
IP_3	Third Order Intercept Point $f = 1.0 \text{ GHz}$	dBm		17.0	
t_{D}	Group Delay $f = 1.0 \text{ GHz}$	psec		125	
V_{d}	Device Voltage	V	4.5	5.0	5.5
dV/dT	Device Voltage Temperature Coefficient	mV/°C		-8.0	

Note:

1. The recommended operating current range for this device is 18 to 40 mA. Typical performance as a function of current is on the following page.

Ordering Information

Part Numbers	No. of Devices	Comments
MSA-0236-BLKG	100	Bulk
MSA-0236-TR1G	1000	7" Reel

MSA-0236 Typical Scattering Parameters ($Z_0 = 50 \Omega$, $T_A = 25^\circ\text{C}$, $I_d = 25 \text{ mA}$)

Freq. GHz	S_{11}		S_{21}			S_{12}			S_{22}	
	Mag	Ang	dB	Mag	Ang	dB	Mag	Ang	Mag	Ang
0.1	.08	170	12.6	4.25	176	-18.6	.118	2	.16	-6
0.2	.08	163	12.5	4.23	171	-18.5	.119	2	.15	-10
0.4	.08	147	12.5	4.19	161	-18.4	.120	4	.15	-21
0.6	.08	130	12.4	4.14	152	-18.3	.121	4	.15	-30
0.8	.07	112	12.2	4.09	143	-18.1	.125	7	.15	-39
1.0	.07	91	12.1	4.02	134	-18.0	.126	10	.15	-46
1.5	.06	47	11.6	3.80	112	-17.3	.137	11	.13	-66
2.0	.03	-1	11.0	3.53	91	-16.3	.153	10	.11	-89
2.5	.03	-115	10.2	3.24	75	-15.4	.169	12	.09	-111
3.0	.09	-157	9.3	2.92	57	-15.1	.176	8	.08	-127
3.5	.16	-175	8.3	2.60	39	-14.4	.190	3	.09	-129
4.0	.20	173	7.2	2.29	23	-14.1	.198	-2	.11	-118
5.0	.27	136	5.2	1.81	-6	-13.5	.211	-11	.15	-117
6.0	.41	94	3.2	1.44	-33	-13.5	.212	-24	.11	-148

Typical Performance, $T_A = 25^\circ\text{C}$

(unless otherwise noted)

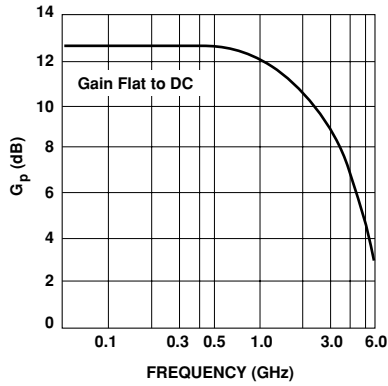
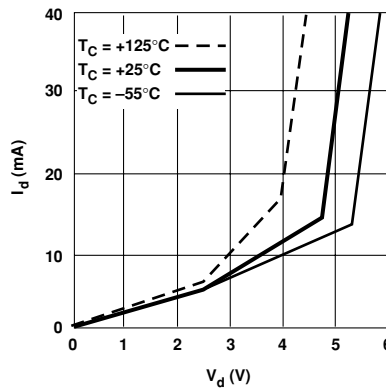
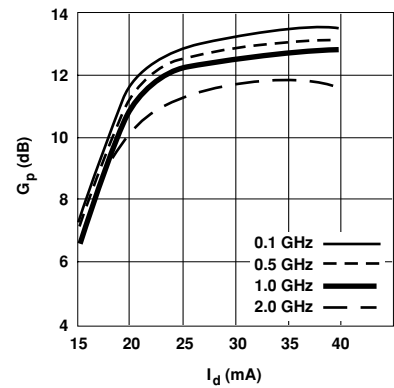
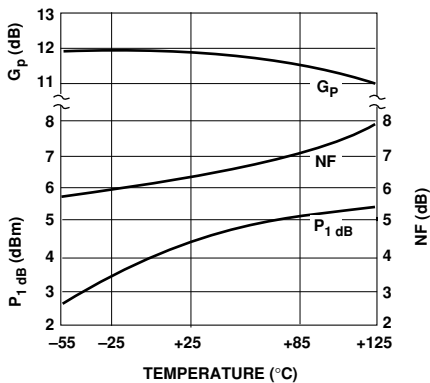
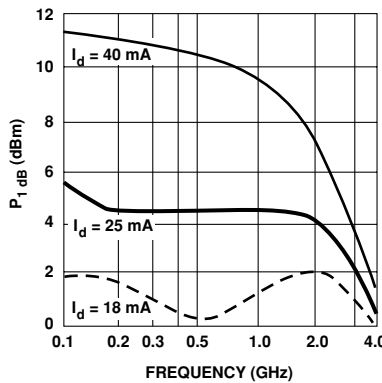
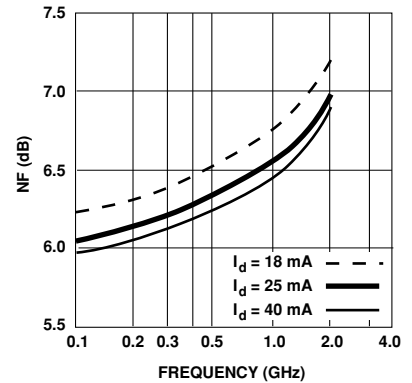
Figure 1. Typical Power Gain vs. Frequency, $T_A = 25^\circ\text{C}$, $I_d = 25 \text{ mA}$.

Figure 2. Device Current vs. Voltage.

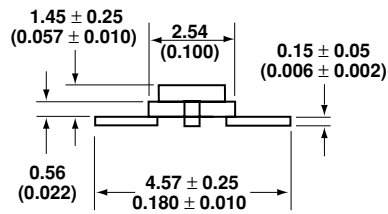
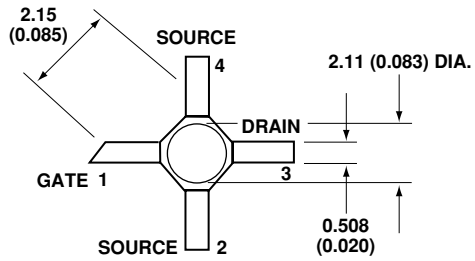
Figure 3. Power Gain vs. Current.

Figure 4. Output Power at 1 dB Gain Compression, NF and Power Gain vs. Mounting Surface Temperature, $f = 1.0 \text{ GHz}$, $I_d = 25 \text{ mA}$.

Figure 5. Output Power at 1 dB Gain Compression vs. Frequency.

Figure 6. Noise Figure vs. Frequency.

36 micro-X Package Dimensions



Notes:

1. Dimensions are in millimeters (inches)
2. Tolerances: in .xxx = ± 0.005
mm .xx = ± 0.13



For product information and a complete list of distributors, please go to our web site: www.avagotech.com

Avago, Avago Technologies, and the A logo are trademarks of Avago Technologies, Limited in the United States and other countries. Data subject to change. Copyright © 2007 Avago Technologies, Limited. All rights reserved. Obsoletes 5989-2738EN AV02-0301EN - April 12, 2007

AVAGO
TECHNOLOGIES

Looking for pricing, stock, or lifecycle information?

Click below to explore more details on WIN SOURCE:

-  [View MSA-0236-TR1G on WIN SOURCE](#)
-  [Broadcom Limited Information](#)

Optimize Your Supply Chain with WIN SOURCE Solutions

-  Global Sourcing Solution
-  Obsolete Management
-  Cost Control Management
-  Shortage Management
-  Alternative Solution
-  Excess Inventory Management