



# THE DATASHEET OF EE-SM3B



# OMRON EE-SM3B

# Photomicrosensor (Transmissive)

## ■ Dimensions

**Note:** All units are in millimeters unless otherwise indicated.

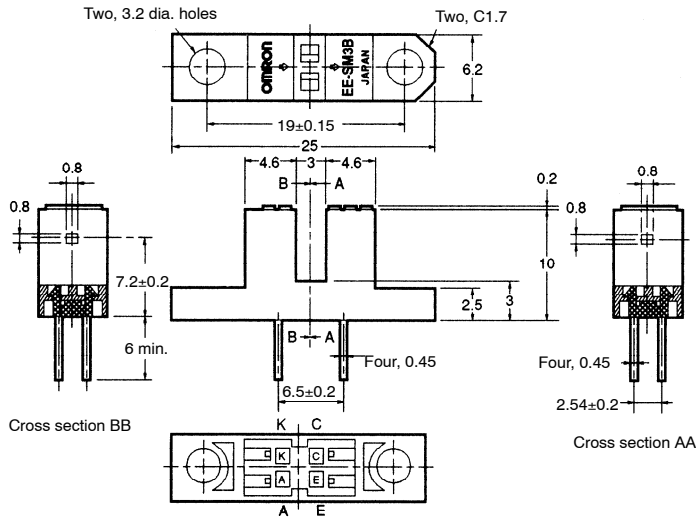

### Internal Circuit

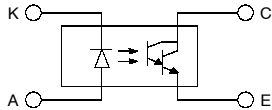

Unless otherwise specified, the tolerances are as shown below.

Dimensions	Tolerance
3 mm max.	±0.3
3 < mm ≤ 6	±0.375
6 < mm ≤ 10	±0.45
10 < mm ≤ 18	±0.55
18 < mm ≤ 30	±0.65

Terminal No.	Name
A	Anode
K	Cathode
C	Collector
E	Emitter

## ■ Features

- General-purpose model with a 3-mm-wide slot.
- PCB mounting type.
- With a red LED as an emitter element and a Photo-Darlington transistor as a detector element.

## ■ Absolute Maximum Ratings (Ta = 25°C)

Item	Symbol	Rated value
Emitter	Forward current	I <sub>F</sub> 15 mA (see note 1)
	Pulse forward current	I <sub>FP</sub> ---
	Reverse voltage	V <sub>R</sub> 4 V
Detector	Collector-Emitter voltage	V <sub>CEO</sub> 24 V
	Emitter-Collector voltage	V <sub>ECO</sub> ---
	Collector current	I <sub>C</sub> 20 mA
	Collector dissipation	P <sub>C</sub> 75 mW (see note 1)
Ambient temperature	Operating	T <sub>opr</sub> -20°C to 60°C
	Storage	T <sub>stg</sub> -20°C to 80°C
Soldering temperature	T <sub>sol</sub>	260°C (see note 2)

- Note:**
1. Refer to the temperature rating chart if the ambient temperature exceeds 25°C.
  2. Complete soldering within 10 seconds.

## ■ Ordering Information

Description	Part number
Photomicrosensor (Transmissive)	EE-SM3B

## ■ Electrical and Optical Characteristics (Ta = 25°C)

Item	Symbol	Value	Condition
Emitter	Forward voltage	V <sub>F</sub> 2.0 V typ., 2.6 V max.	I <sub>F</sub> = 15 mA
	Reverse current	I <sub>R</sub> 0.01 μA typ., 5 μA max.	V <sub>R</sub> = 4 V
	Peak emission wavelength	λ <sub>P</sub> 700 nm typ.	I <sub>F</sub> = 3 mA
Detector	Light current	I <sub>L</sub> 1.5 mA min., 120 mA max.	I <sub>F</sub> = 3 mA, V <sub>CE</sub> = 10 V
	Dark current	I <sub>D</sub> 2 nA typ., 250 nA max.	V <sub>CE</sub> = 10 V, 0 lx
	Leakage current	I <sub>LEAK</sub> ---	---
	Collector-Emitter saturated voltage	V <sub>CE (sat)</sub> 0.9 V typ.	I <sub>F</sub> = 3 mA, I <sub>L</sub> = 0.5 mA
	Peak spectral sensitivity wavelength	λ <sub>P</sub> 800 nm typ.	V <sub>CE</sub> = 10 V
Rising time	t <sub>r</sub>	180 μs typ.	V <sub>CC</sub> = 5 V, R <sub>L</sub> = 100 Ω, I <sub>L</sub> = 10 mA
Falling time	t <sub>f</sub>	60 μs typ.	V <sub>CC</sub> = 5 V, R <sub>L</sub> = 100 Ω, I <sub>L</sub> = 10 mA

■ Engineering Data

Forward Current vs. Collector Dissipation Temperature Rating

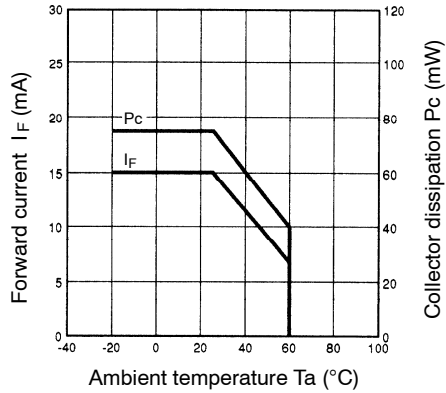

Forward Current vs. Forward Voltage Characteristics (Typical)

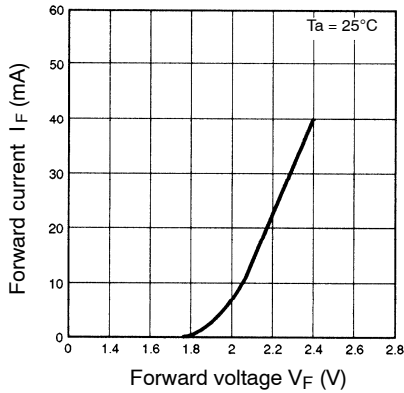

Light Current vs. Forward Current Characteristics (Typical)

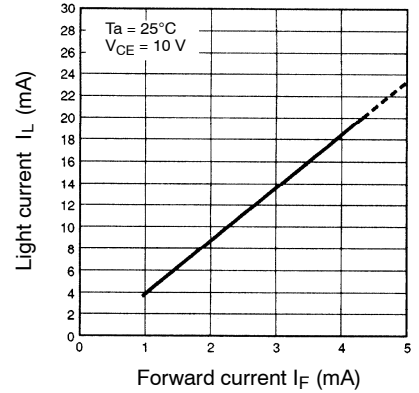

Light Current vs. Collector-Emitter Voltage Characteristics (Typical)

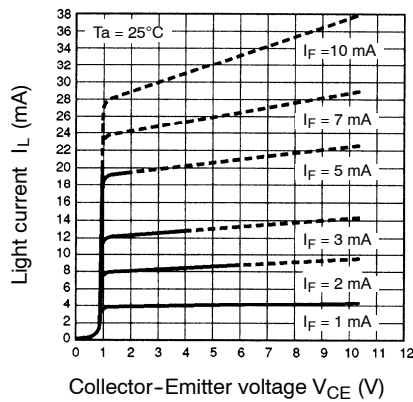

Relative Light Current vs. Ambient Temperature Characteristics (Typical)

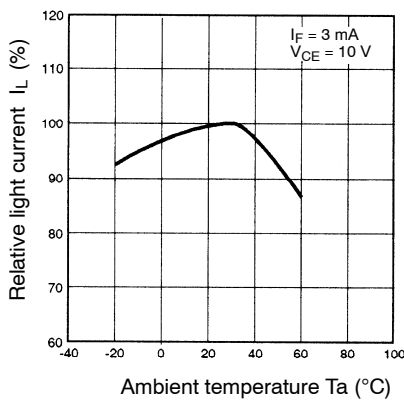

Dark Current vs. Ambient Temperature Characteristics (Typical)

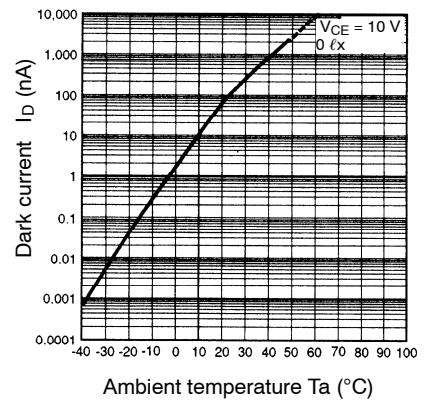

Response Time vs. Load Resistance Characteristics (Typical)

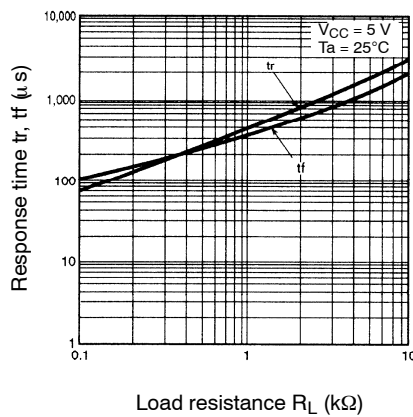

Sensing Position Characteristics (Typical)

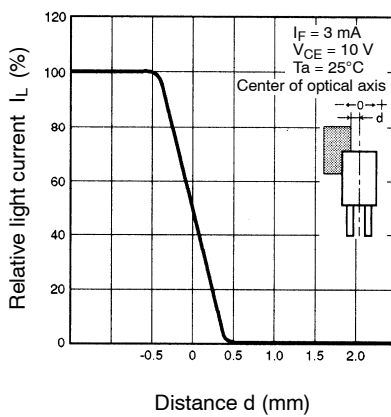

Response Time Measurement Circuit

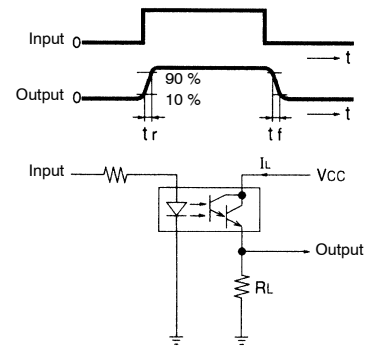

**NOTE: DIMENSIONS SHOWN ARE IN MILLIMETERS. To convert millimeters to inches divide by 25.4.**

---

**OMRON**<sup>®</sup>

**OMRON ELECTRONICS LLC**

One East Commerce Drive  
Schaumburg, IL 60173

**847-882-2288**

**OMRON CANADA, INC.**

885 Milner Avenue  
Toronto, Ontario M1B 5V8

**416-286-6465**

**OMRON ON-LINE**

Global – <http://www.omron.com>  
USA – <http://www.omron.com/oei>  
Canada – <http://www.omron.com/oci>

## Looking for pricing, stock, or lifecycle information?

Click below to explore more details on WIN SOURCE:

 [View EE-SM3B on WIN SOURCE](#)

 [Omron Information](#)

## Optimize Your Supply Chain with WIN SOURCE Solutions

-  Global Sourcing Solution
-  Obsolete Management
-  Cost Control Management
-  Shortage Management
-  Alternative Solution
-  Excess Inventory Management