



**THE DATASHEET OF
ESH2D-E3/5BT**



Surface-Mount Ultrafast Plastic Rectifier

SMB (DO-214AA)

 Cathode  Anode

FEATURES

- Glass passivated pellet chip junction
- Ideal for automated placement
- Ultrafast recovery times for high efficiency
- Low forward voltage, low power loss
- High forward surge capability
- Meets MSL level 1, per J-STD-020, LF maximum peak of 260 °C
- AEC-Q101 qualified available
- Automotive ordering code: base P/NHE3
- Material categorization: for definitions of compliance please see www.vishay.com/doc?99912

 AUTOMOTIVE
GRADE
Available

RoHS
COMPLIANT

LINKS TO ADDITIONAL RESOURCES

[3D Models](#)

TYPICAL APPLICATIONS

For use in high frequency rectification and freewheeling application in switching mode converter and inverter for both consumer and automotive.

MECHANICAL DATA

Case: SMB (DO-214AA)

Molding compound meets UL 94 V-0 flammability rating
Base P/N-E3 - RoHS-compliant, commercial grade
Base P/NHE3_X - RoHS-compliant, AEC-Q101 qualified (“_X” denotes revision code e.g. A, B,....)

Terminals: matte tin plated leads, solderable per J-STD-002 and JESD 22-B102

E3 suffix meets JESD 201 class 1A whisker test, HE3 suffix meets JESD 201 class 2 whisker test

Polarity: color band denotes cathode end

PRIMARY CHARACTERISTICS	
$I_{F(AV)}$	2.0 A
V_{RRM}	100 V, 150 V, 200 V
t_r	25 ns
V_F at $I_F = 2$ A	0.93 V
T_J max.	175 °C
Package	SMB (DO-214AA)
Circuit configuration	Single

MAXIMUM RATINGS ($T_A = 25$ °C unless otherwise noted)					
PARAMETER	SYMBOL	ESH2B	ESH2C	ESH2D	UNIT
Device marking code		EHB	EHC	EHD	
Maximum repetitive peak reverse voltage	V_{RRM}	100	150	200	V
Maximum RMS voltage	V_{RMS}	70	105	140	V
Maximum DC blocking voltage	V_{DC}	100	150	200	V
Maximum average forward rectified current (fig. 1)	$I_{F(AV)}$	2.0			A
Peak forward surge current 8.3 ms single half sine-wave superimposed on rated load	I_{FSM}	60			A
Operating junction and storage temperature range	T_J, T_{STG}	-55 to +175			°C



ELECTRICAL CHARACTERISTICS ($T_A = 25\text{ }^\circ\text{C}$ unless otherwise noted)						
PARAMETER	TEST CONDITIONS		SYMBOL	VALUE	UNIT	
Maximum instantaneous forward voltage	$I_F = 2\text{ A}$		$V_F^{(1)}$	0.93	V	
Maximum DC reverse current at rated DC blocking voltage			I_R	$T_A = 25\text{ }^\circ\text{C}$	2.0	μA
				$T_A = 125\text{ }^\circ\text{C}$	50	
Maximum reverse recovery time	$I_F = 0.5\text{ A}, I_R = 1\text{ A}, I_{rr} = 0.25\text{ A}$		t_{rr}	25	ns	
Typical reverse recovery time	$I_F = 2\text{ A}, V_R = 30\text{ V},$ $di/dt = 50\text{ A}/\mu\text{s}, I_{rr} = 10\% I_{RM}$		t_{rr}	$T_J = 25\text{ }^\circ\text{C}$	35	ns
				$T_J = 100\text{ }^\circ\text{C}$	55	
Typical stored charge	$I_F = 2\text{ A}, V_R = 30\text{ V},$ $di/dt = 50\text{ A}/\mu\text{s}, I_{rr} = 10\% I_{RM}$		Q_{rr}	$T_J = 25\text{ }^\circ\text{C}$	20	nC
				$T_J = 100\text{ }^\circ\text{C}$	35	
Typical junction capacitance	4.0 V, 1 MHz		C_J	30	pF	

Note(1) Pulse test: 300 μs pulse width, 1 % duty cycle

THERMAL CHARACTERISTICS ($T_A = 25\text{ }^\circ\text{C}$ unless otherwise noted)					
PARAMETER	SYMBOL	ESH2B	ESH2C	ESH2D	UNIT
Typical thermal resistance	$R_{\theta JA}^{(1)}$	65			$^\circ\text{C}/\text{W}$
	$R_{\theta JL}^{(1)}$	20			

Note

(1) Units mounted on PCB with 8.0 mm x 8.0 mm land areas

ORDERING INFORMATION (Example)				
PREFERRED P/N	UNIT WEIGHT (g)	PREFERRED PACKAGE CODE	BASE QUANTITY	DELIVERY MODE
ESH2D-E3/52T	0.096	52T	750	7" diameter plastic tape and reel
ESH2D-E3/5BT	0.096	5BT	3200	13" diameter plastic tape and reel
ESH2DHE3_A/H ⁽¹⁾	0.096	H	750	7" diameter plastic tape and reel
ESH2DHE3_A/I ⁽¹⁾	0.096	I	3200	13" diameter plastic tape and reel

Note

(1) AEC-Q101 qualified



RATINGS AND CHARACTERISTICS CURVES ($T_A = 25\text{ }^\circ\text{C}$ unless otherwise noted)

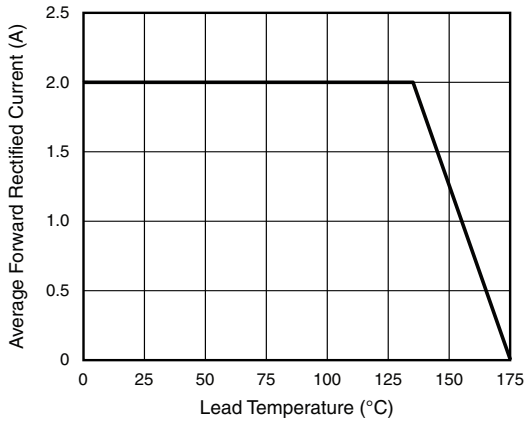

Fig. 1 - Maximum Forward Current Derating Curve

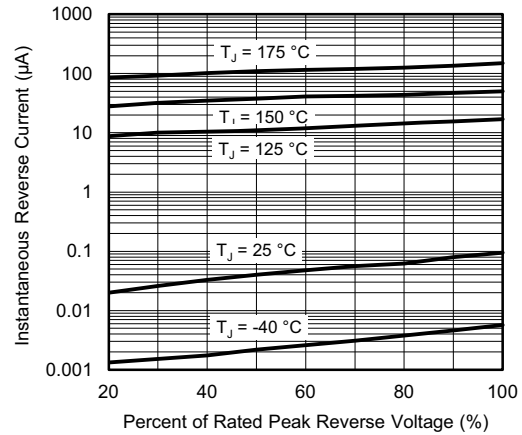

Fig. 4 - Typical Reverse Leakage Characteristics

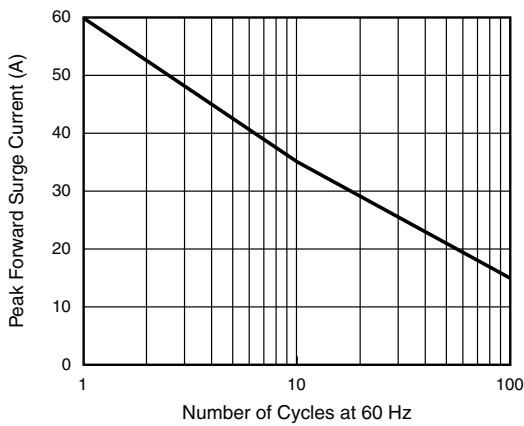

Fig. 2 - Maximum Non-Repetitive Peak Forward Surge Current

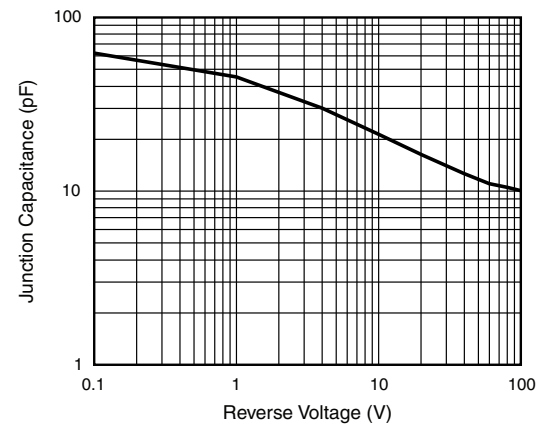

Fig. 5 - Typical Junction Capacitance

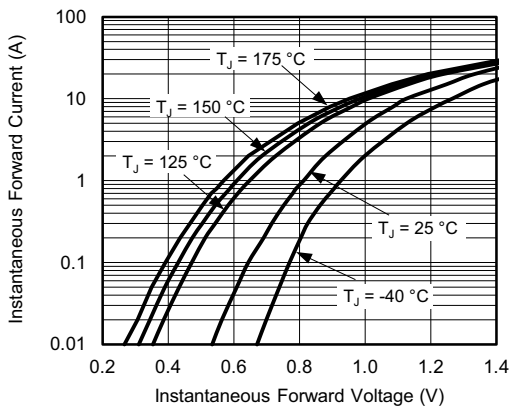

Fig. 3 - Typical Instantaneous Forward Characteristics

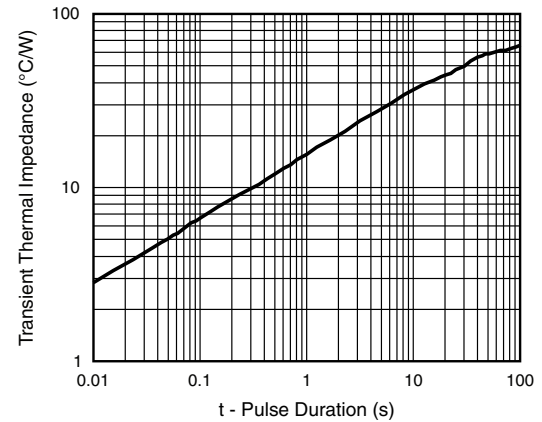
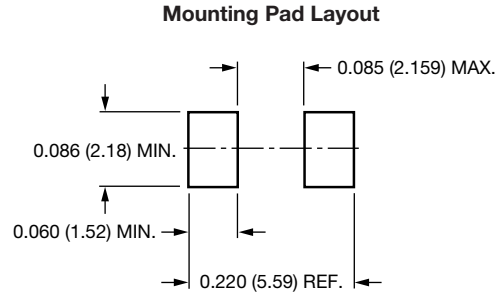
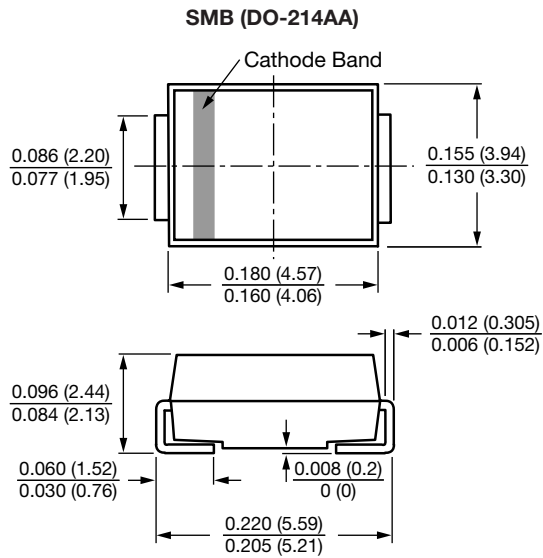

Fig. 6 - Typical Transient Thermal Impedance



PACKAGE OUTLINE DIMENSIONS in inches (millimeters)





Disclaimer

ALL PRODUCT, PRODUCT SPECIFICATIONS AND DATA ARE SUBJECT TO CHANGE WITHOUT NOTICE TO IMPROVE RELIABILITY, FUNCTION OR DESIGN OR OTHERWISE.

Vishay Intertechnology, Inc., its affiliates, agents, and employees, and all persons acting on its or their behalf (collectively, "Vishay"), disclaim any and all liability for any errors, inaccuracies or incompleteness contained in any datasheet or in any other disclosure relating to any product.

Vishay makes no warranty, representation or guarantee regarding the suitability of the products for any particular purpose or the continuing production of any product. To the maximum extent permitted by applicable law, Vishay disclaims (i) any and all liability arising out of the application or use of any product, (ii) any and all liability, including without limitation special, consequential or incidental damages, and (iii) any and all implied warranties, including warranties of fitness for particular purpose, non-infringement and merchantability.

Statements regarding the suitability of products for certain types of applications are based on Vishay's knowledge of typical requirements that are often placed on Vishay products in generic applications. Such statements are not binding statements about the suitability of products for a particular application. It is the customer's responsibility to validate that a particular product with the properties described in the product specification is suitable for use in a particular application. Parameters provided in datasheets and / or specifications may vary in different applications and performance may vary over time. All operating parameters, including typical parameters, must be validated for each customer application by the customer's technical experts. Product specifications do not expand or otherwise modify Vishay's terms and conditions of purchase, including but not limited to the warranty expressed therein.

Hyperlinks included in this datasheet may direct users to third-party websites. These links are provided as a convenience and for informational purposes only. Inclusion of these hyperlinks does not constitute an endorsement or an approval by Vishay of any of the products, services or opinions of the corporation, organization or individual associated with the third-party website. Vishay disclaims any and all liability and bears no responsibility for the accuracy, legality or content of the third-party website or for that of subsequent links.

Except as expressly indicated in writing, Vishay products are not designed for use in medical, life-saving, or life-sustaining applications or for any other application in which the failure of the Vishay product could result in personal injury or death. Customers using or selling Vishay products not expressly indicated for use in such applications do so at their own risk. Please contact authorized Vishay personnel to obtain written terms and conditions regarding products designed for such applications.

No license, express or implied, by estoppel or otherwise, to any intellectual property rights is granted by this document or by any conduct of Vishay. Product names and markings noted herein may be trademarks of their respective owners.

Looking for pricing, stock, or lifecycle information?

Click below to explore more details on WIN SOURCE:

 [View ESH2D-E3/5BT on WIN SOURCE](#)

 [Vishay Information](#)

Optimize Your Supply Chain with WIN SOURCE Solutions

-  Global Sourcing Solution
-  Obsolete Management
-  Cost Control Management
-  Shortage Management
-  Alternative Solution
-  Excess Inventory Management